

Grid Type: Profile All  
Top Sash Grid Pattern: 3W2H  
Bottom Sash Grid Pattern: 3W2H  
Screen: Deluxe Locking Extruded Half Screen  
Screen Mesh: Fiberglass  
Evolution Package: Evo Package  
Frame Options: None  
Lead Time: 21 Days

Project Total:            \$1,523.05

Salesperson: MARK MORISSETTE (S1946MM3)

Accepted by: \_\_\_\_\_

Date: 02/28/2007

[Print this Page](#)

This Millwork Quote is valid until 12/12/2006. This is an estimate only. This estimate does not include tax or delivery charges. Delivery of all materials contained in this estimate are subject to availability from the manufacturer or supplier. All the above quantities, dimensions, specifications and accessories have been verified and accepted.

[Back to Quote](#)

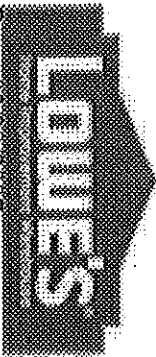

LOWE'S HOME CENTERS, INC.  
 #1946  
 1058 BRIGHTON AVENUE  
 PORTLAND, ME 4102  
 (207) 482-2800

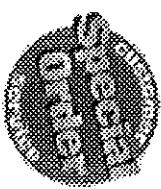

Date: 02/28/2007

Project #: 187239585  
 Customer Name: WILDCAT LLC  
 WILDCAT LLC  
 (207) 632-4128  
 Customer Address: 929&931 CONGRESS  
 CURRENT JOBSITE  
 PORTLAND ME 04103

Description: Unit #3windows

Line Item  
 Frame Size

Product Code  
 Description

Unit Price Quantity Total Price

0001  
 Frame Size = 2' 10" W x 5'  
 10" H  
 EXACT OPENING  
 SELECTED

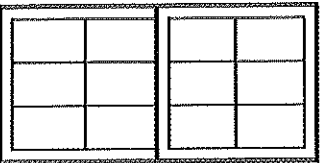

Manufacturer: ReliablIt by Survivor  
 Product Category: Windows  
 Product Type: Double Hungs  
 Material: Vinyl  
 Product Line: Replacement  
 Series : 7100  
 Product Configuration: Standard  
 Exterior Color: White  
 Opening Type: Exact  
 High Performance Package: High Performance  
 Package  
 Glass Option Top Sash: Low E/Argon/Double  
 Strength  
 Glass Option Bottom Sash: Low E/Argon/Double  
 Strength  
 Grid Type: Profile All  
 Top Sash Grid Pattern: 3W2H  
 Bottom Sash Grid Pattern: 3W2H  
 Screen: Deluxe Locking Extruded Half Screen  
 Screen Mesh: Fiberglass  
 Evolution Package: Evo Package  
 Frame Options: None  
 Lead Time: 21 Days

\$307.86 2 \$615.72

Salesperson: MARK MORISSETTE (S1946MM3)

Project Total: \$615.72

Accepted by: \_\_\_\_\_

Date: 02/28/2007

[Print this Page](#)

This Millwork Quote is valid until 2/11/2007. This is an estimate only. This estimate does not include tax or delivery charges. Delivery of all materials contained in this estimate are subject to availability from the manufacturer or supplier. All the above quantities, dimensions, specifications and accessories have been verified and accepted.

[Back to Quote](#)

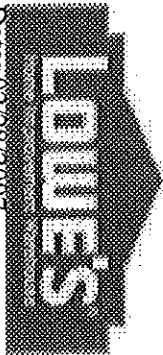

LOWE'S HOME CENTERS, INC.  
 #1946  
 1058 BRIGHTON AVENUE  
 PORTLAND, ME 4102  
 (207) 482-2800

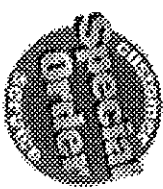

Date: 02/28/2007

Project #: 185497423  
 Customer Name: WILDCAT LLC  
 WILDCAT LLC  
 (207) 632-4128  
 Customer Phone: 929&931 CONGRESS  
 CURRENT JOBSITE  
 PORTLAND ME 04103

Description: Unit 4 with Hall 2 Windows

Line Item  
 Frame Size

Product Code  
 Description

Unit Price Quantity Total Price

0001  
 Frame Size = 3' 3" W x 6'  
 0" H  
 EXACT OPENING  
 SELECTED

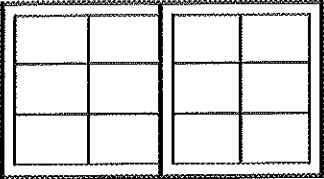

Manufacturer: Reliabilt by Survivor  
 Product Category: Windows  
 Product Type: Double Hungs  
 Material: Vinyl  
 Product Line: Replacement  
 Series : 7100  
 Product Configuration: Standard  
 Exterior Color: White  
 Opening Type: Exact  
 High Performance Package: High Performance  
 Package  
 Glass Option Top Sash: Low E/Argon/Double  
 Strength  
 Glass Option Bottom Sash: Low E/Argon/Double  
 Strength  
 Grid Type: Profile All  
 Top Sash Grid Pattern: 3W2H  
 Bottom Sash Grid Pattern: 3W2H  
 Screen: Deluxe Locking Extruded Half Screen  
 Screen Mesh: Fiberglass  
 Evolution Package: Evo Package  
 Frame Options: None  
 Lead Time: 21 Days

\$307.86 1 \$307.86

0002  
 Frame Size = 2' 10" W x 5'  
 10" H  
 EXACT OPENING  
 SELECTED

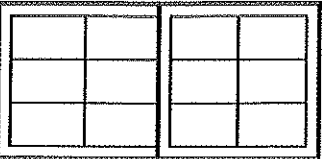

Manufacturer: Reliabilt by Survivor  
 Product Category: Windows  
 Product Type: Double Hungs  
 Material: Vinyl  
 Product Line: Replacement  
 Series : 7100  
 Product Configuration: Standard  
 Exterior Color: White  
 Opening Type: Exact  
 High Performance Package: High Performance  
 Package  
 Glass Option Top Sash: Low E/Argon/Double  
 Strength  
 Glass Option Bottom Sash: Low E/Argon/Double  
 Strength

\$307.86 3 \$923.58

Grid Type: Profile All  
 Top Sash Grid Pattern: 3W2H  
 Bottom Sash Grid Pattern: 3W2H  
 Screen: Deluxe Locking Extruded Half Screen  
 Screen Mesh: Fiberglass  
 Evolution Package: Evo Package  
 Frame Options: None  
 Lead Time: 21 Days

0003  
 Frame Size = 3' 0" W x 5'  
 10" H  
**EXACT OPENING  
 SELECTED**

Manufacturer: ReliABilt by Survivor

Product Category: Windows  
 Product Type: Double Hungs  
 Material: Viny1  
 Product Line: Replacement  
 Series : 7100  
 Product Configuration: Standard  
 Exterior Color: White  
 Opening Type: Exact  
 High Performance Package: High Performance  
 Package  
 Glass Option Top Sash: Low E/Argon/Double  
 Strength  
 Glass Option Bottom Sash: Low E/Argon/Double  
 Strength  
 Grid Type: Profile All  
 Top Sash Grid Pattern: 3W2H  
 Bottom Sash Grid Pattern: 3W2H  
 Screen: Deluxe Locking Extruded Half Screen  
 Screen Mesh: Fiberglass  
 Evolution Package: Evo Package  
 Frame Options: None  
 Lead Time: 21 Days

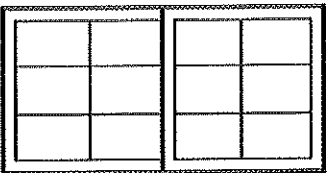

\$307.86	1	\$307.86
----------	---	----------

Project Total: \$1,539.30

Salesperson: MARK MORISSETTE (S1946MM3)

Accepted by: \_\_\_\_\_

Date: 02/28/2007

[Print this Page](#)

This Millwork Quote is valid until 1/28/2007. This is an estimate only. This estimate does not include tax or delivery charges. Delivery of all materials contained in this estimate are subject to availability from the manufacturer or supplier. All the above quantities, dimensions, specifications and accessories have been verified and accepted.

[Back to Quote](#)

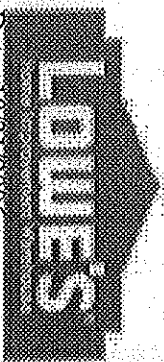

LOWE'S HOME CENTERS, INC.  
#1946  
1058 BRIGHTON AVENUE  
PORTLAND, ME 4102  
(207) 482-2800

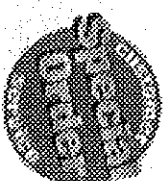

Date: 10/31/2006

Congress & Valley Unit 5 (cpy)

Project #: 175337001  
Customer Name: FRED DAMBRUE  
Customer Phone: (207) 632-4128  
Customer Address: 929&931 CONGRESS  
CURRENT JOBSITE  
PORTLAND ME 04103

Line Item  
Frame Size

Product Code  
Description

Unit Price Quantity Total Price

*Order*  
**10/31**

0001  
Frame Size = 3' 2 1/2" W x  
5' 9" H  
EXACT OPENING  
SELECTED

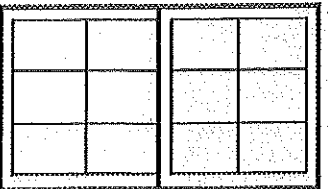

Manufacturer: ReliablIt by Survivor  
Product Category: Windows  
Product Type: Double Hungs  
Material: Vinyl  
Product Line: Replacement  
Series : 7100  
Product Configuration: Standard  
Exterior Color: White  
Opening Type: Exact  
High Performance Package: High Performance  
Package  
Glass Option Top Sash: Low E/Argon/Double  
Strength  
Glass Option Bottom Sash: Low E/Argon/Double  
Strength  
Grid Type: Profile All  
Top Sash Grid Pattern: 3W2H  
Bottom Sash Grid Pattern: 3W2H  
Screen: Deluxe Locking Extended Half Screen  
Screen Mesh: Fiberglass  
Evolution Package: Evo Package  
Frame Options: None  
Lead Time: 21 Days

\$307.86 5 \$1,539.30

0002  
Frame Size = 2' 10" W x 5'  
9" H  
EXACT OPENING  
SELECTED

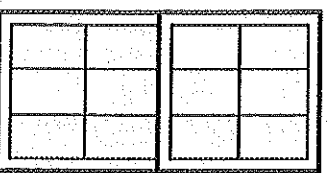

Manufacturer: ReliablIt by Survivor  
Product Category: Windows  
Product Type: Double Hungs  
Material: Vinyl  
Product Line: Replacement  
Series : 7100  
Product Configuration: Standard  
Exterior Color: White  
Opening Type: Exact  
High Performance Package: High Performance  
Package  
Glass Option Top Sash: Low E/Argon/Double  
Strength  
Glass Option Bottom Sash: Low E/Argon/Double  
Strength  
Grid Type: Profile All

\$307.86 2 \$615.72

Top Sash Grid Pattern: 3W2H  
Bottom Sash Grid Pattern: 3W2H  
Screen: Deluxe Locking Extruded Half Screen  
Screen Mesh: Fiberglass  
Evolution Package: Evo Package  
Frame Options: None  
Lead Time: 21 Days

Project Total: \$2,155.02

Salesperson: MARK MORISSETTE (S1946MM3)

Date: 10/31/2006

[Print This Page](#)

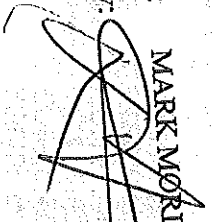
Accepted by: 

This Millwork Quote is valid until 11/6/2006. This is an estimate only. This estimate does not include tax or delivery charges. Delivery of all materials contained in this estimate are subject to availability from the manufacturer or supplier. All the above quantities, dimensions, specifications and accessories have been verified and accepted.

Back to Quote

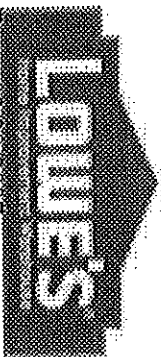

LOWE'S HOME CENTERS, INC.  
 #1946  
 1058 BRIGHTON AVENUE  
 PORTLAND, ME 4102  
 (207) 482-2800

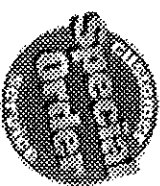

Date: 02/28/2007

Project #: 180114296  
 Customer Name: WILDCAT LLC  
 WILDCAT LLC  
 (207) 632-4128  
 Customer Address: 929&931 CONGRESS  
 CURRENT JOBSITE  
 PORTLAND ME 04103

Description:

Unit #6 Replacement Windows

Line Item  
 Frame Size

Product Code  
 Description

Unit Price Quantity Total Price

0001 Frame Size = 3' 2 1/2" W x 5' 9" H EXACT OPENING SELECTED	Manufacturer: ReliBilt by Survivor Product Category: Windows Product Type: Double Hungs Material: Vinyl Product Line: Replacement Series : 7100 Product Configuration: Standard Exterior Color: White Opening Type: Exact High Performance Package: High Performance Package Glass Option Top Sash: Low E/Argon/Double Strength Glass Option Bottom Sash: Low E/Argon/Double Strength Grid Type: Profile All Top Sash Grid Pattern: 3W2H Bottom Sash Grid Pattern: 3W2H Screen: Deluxe Locking Extruded Half Screen Screen Mesh: Fiberglass Evolution Package: Evo Package Frame Options: None Lead Time: 21 Days	\$307.86      4      \$1,231.44
0002 Frame Size = 2' 11" W x 5' 9" H EXACT OPENING SELECTED	Manufacturer: ReliBilt by Survivor Product Category: Windows Product Type: Double Hungs Material: Vinyl Product Line: Replacement Series : 7100 Product Configuration: Standard Exterior Color: White Opening Type: Exact High Performance Package: High Performance Package Glass Option Top Sash: Low E/Argon/Double Strength Glass Option Bottom Sash: Low E/Argon/Double Strength	\$307.86      1      \$307.86

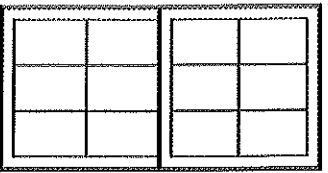

Grid Type: Profile All  
Top Sash Grid Pattern: 3 W2H  
Bottom Sash Grid Pattern: 3 W2H  
Screen: Deluxe Locking Extruded Half Screen  
Screen Mesh: Fiberglass  
Evolution Package: Evo Package  
Frame Options: None  
Lead Time: 21 Days

Project Total:            \$1,539.30

Salesperson: **MARK MORISSETTE (S1946MM3)**

Date: 02/28/2007

Accepted by: \_\_\_\_\_

[Print this Page](#)

This Millwork Quote is valid until 12/12/2006. This is an estimate only. This estimate does not include tax or delivery charges. Delivery of all materials contained in this estimate are subject to availability from the manufacturer or supplier. All the above quantities, dimensions, specifications and accessories have been verified and accepted.



Back to Quote

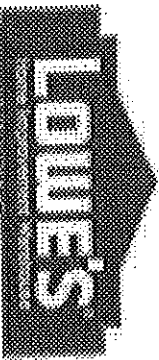

LOWE'S HOME CENTERS, INC.  
 #1946  
 1058 BRIGHTON AVENUE  
 PORTLAND, ME 4102  
 (207) 482-2800

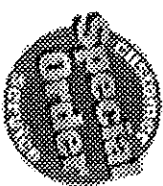

Date: 02/28/2007

Project #: 183146142  
 Customer Name: WILDCAT LLC  
 WILDCAT LLC  
 (207) 632-4128  
 Customer Phone: 929&931 CONGRESS  
 CURRENT JOBSITE  
 PORTLAND ME 04103

Description:

Unit #7 Windows

Line Item  
 Frame Size

Product Code  
 Description

Unit Price Quantity Total Price

0001 Frame Size = 2' 11" W x 5' 11" H EXACT OPENING SELECTED		Manufacturer: ReliablIt by Survivor Product Category: Windows Product Type: Double Hungs Material: Vinyl Product Line: Replacement Series : 7100 Product Configuration: Standard Exterior Color: White Opening Type: Exact High Performance Package: High Performance Package Glass Option Top Sash: Low E/Argon/Double Strength Glass Option Bottom Sash: Low E/Argon/Double Strength Grid Type: Profile All Top Sash Grid Pattern: 3W2H Bottom Sash Grid Pattern: 3W2H Screen: Deluxe Locking Extruded Half Screen Screen Mesh: Fiberglass Evolution Package: Evo Package Frame Options: None Lead Time: 21 Days	\$307.86    2    \$615.72
0002 Frame Size = 2' 11" W x 5' 10" H EXACT OPENING SELECTED		Manufacturer: ReliablIt by Survivor Product Category: Windows Product Type: Double Hungs Material: Vinyl Product Line: Replacement Series : 7100 Product Configuration: Standard Exterior Color: White Opening Type: Exact High Performance Package: High Performance Package Glass Option Top Sash: Low E/Argon/Double Strength Glass Option Bottom Sash: Low E/Argon/Double Strength	\$307.86    3    \$923.58

Grid Type: Profile All  
Top Sash Grid Pattern: 3W2H  
Bottom Sash Grid Pattern: 3W2H  
Screen: Deluxe Locking Extruded Half Screen  
Screen Mesh: Fiberglass  
Evolution Package: Evo Package  
Frame Options: None  
Lead Time: 21 Days

Project Total:     \$1,539.30    

Salesperson: **MARK MORISSETTE (S1946MM3)**

Accepted by: \_\_\_\_\_

Date: 02/28/2007

**Print this Page**

This Millwork Quote is valid until 1/9/2007. This is an estimate only. This estimate does not include tax or delivery charges. Delivery of all materials contained in this estimate are subject to availability from the manufacturer or supplier. All the above quantities, dimensions, specifications and accessories have been verified and accepted.

[Back to Quote](#)

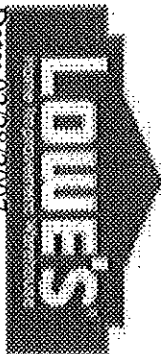

LOWE'S HOME CENTERS, INC.  
 #1946  
 1058 BRIGHTON AVENUE  
 PORTLAND, ME 4102  
 (207) 482-2800

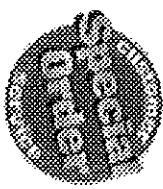

Date: 02/28/2007

Project #: 183103233  
 Customer Name: WILDCAT LLC  
 WILDCAT LLC  
 (207) 632-4128  
 Customer Address: 929&931 CONGRESS  
 CURRENT JOBSITE  
 PORTLAND ME 04103

Description: Unit # 8 windows

Line Item  
 Frame Size

Product Code  
 Description

Unit Price Quantity Total Price

0001	Frame Size = 2' 11" W x 5' 11" H EXACT OPENING SELECTED	Manufacturer: Reliabilt by Survivor Product Category: Windows Product Type: Double Hungs Material: Vinyl Product Line: Replacement Series : 7100 Product Configuration: Standard Exterior Color: White Opening Type: Exact High Performance Package: High Performance Package Glass Option Top Sash: Low E/Argon/Double Strength Glass Option Bottom Sash: Low E/Argon/Double Strength	\$307.86	2	\$615.72
0002	Frame Size = 2' 10" W x 5' 10" H EXACT OPENING SELECTED	Manufacturer: Reliabilt by Survivor Product Category: Windows Product Type: Double Hungs Material: Vinyl Product Line: Replacement Series : 7100 Product Configuration: Standard Exterior Color: White Opening Type: Exact High Performance Package: High Performance Package Glass Option Top Sash: Low E/Argon/Double Strength Glass Option Bottom Sash: Low E/Argon/Double Strength	\$307.86	1	\$307.86

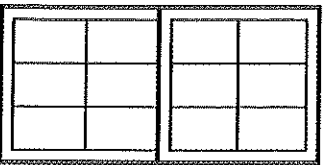
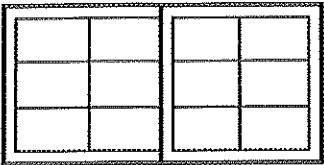

Grid Type: Profile All  
 Top Sash Grid Pattern: 3W2H  
 Bottom Sash Grid Pattern: 3W2H  
 Screen: Deluxe Locking Extruded Half Screen  
 Screen Mesh: Fiberglass  
 Evolution Package: Evo Package  
 Frame Options: None  
 Lead Time: 21 Days

0003  
 Frame Size = 2' 10" W x 5'  
 10" H  
 EXACT OPENING  
 SELECTED

Manufacturer: ReliaBlt by Survivor

Product Category: Windows  
 Product Type: Double Hungs  
 Material: Vinyl  
 Product Line: Replacement  
 Series : 7100  
 Product Configuration: Standard  
 Exterior Color: White  
 Opening Type: Exact  
 High Performance Package: High Performance  
 Package  
 Glass Option Top Sash: Low E/Argon/Double  
 Strength  
 Glass Option Bottom Sash: Low E/Argon/Double  
 Strength  
 Grid Type: Profile All  
 Top Sash Grid Pattern: 3W2H  
 Bottom Sash Grid Pattern: 3W2H  
 Screen: Deluxe Locking Extruded Half Screen  
 Screen Mesh: Fiberglass  
 Evolution Package: Evo Package  
 Frame Options: None  
 Lead Time: 21 Days

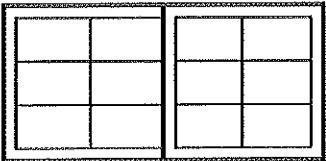

\$307.86 1 \$307.86

Project Total: \$1,231.44

Salesperson: MARK MORISSETTE (S1946MM3)

Accepted by: \_\_\_\_\_

Date: 02/28/2007

[Print this Page](#)

This Millwork Quote is valid until 1/9/2007. This is an estimate only. This estimate does not include tax or delivery charges. Delivery of all materials contained in this estimate are subject to availability from the manufacturer or supplier. All the above quantities, dimensions, specifications and accessories have been verified and accepted.

[Back to Quote](#)

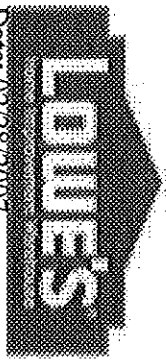

LOWE'S HOME CENTERS, INC.

#1946

1058 BRIGHTON AVENUE  
PORTLAND, ME 4102  
(207) 482-2800

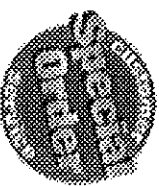

Date: 02/28/2007

Description: **Bar Window redo 4th time**

Project #: 189328941  
Customer Name: WILDCAT LLC  
WILDCAT LLC  
Customer Phone: (207) 632-4128  
Customer Address: 929&931 CONGRESS  
CURRENT JOBSITE  
PORTLAND ME 04103

Line Item	Product Code	Unit Price	Quantity	Total Price
Frame Size	Description			

0001  
 Frame Size = 2' 10" W x 6'  
 3" H  
**EXACT OPENING  
 SELECTED**

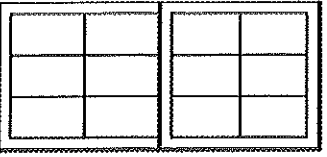

Manufacturer: Reliable by Survivor  
 Product Category: Windows  
 Product Type: Double Hungs  
 Material: Vinyl  
 Product Line: Replacement  
 Series : 7100  
 Product Configuration: Standard  
 Exterior Color: White  
 Opening Type: Exact  
 High Performance Package: High Performance  
 Package  
 Glass Option Top Sash: Low E/Argon/Double  
 Strength  
 Glass Option Bottom Sash: Low E/Argon/Double  
 Strength  
 Grid Type: Profile All  
 Top Sash Grid Pattern: 3W2H  
 Bottom Sash Grid Pattern: 3W2H  
 Screen: Deluxe Locking Extruded Half Screen  
 Screen Mesh: Fiberglass  
 Evolution Package: Evo Package  
 Frame Options: None  
 Lead Time: 21 Days

\$307.86	2	\$615.72
----------	---	----------

Salesperson: MARK MORISSETTE (S1946MM3) Project Total: \$615.72

Accepted by: \_\_\_\_\_ Date: 02/28/2007

[Print this Page](#)

This Millwork Quote is valid until 2/27/2007. This is an estimate only. This estimate does not include tax or delivery charges. Delivery of all materials contained in this estimate are subject to availability from the manufacturer or supplier. All the above quantities, dimensions, specifications and accessories have been verified and accepted.

# FAX

---

TO FAX#: 912074822803

EXTENSION:

FROM: Adam Whitehead, 6363

*Windows Specs*

PAGES: 20 (INCLUDING THIS COVER PAGE)

SUBMITTED: 2/28/07 1:26:23 PM

---

If this facsimile is not completely readable or is missing pages, please inform the person who requested the information. That person will have to re-request the information from this service.

# RADIUS SHAPE WINDOWS



## Section Directory



### General Information

Product Summary .....	6-2
Product Selection Guide .....	
Size and Performance Data .....	6-3
Features and Options .....	6-3
Glazing Performance .....	6-4
Grille Types .....	
Grille Options .....	6-5
Grille Configuration Options .....	6-5
Radius Shapes .....	6-6
Size Tables-Quarter and Half Circle .....	6-7

### 10 Series

Design Data .....	6-8
Detailed Product Descriptions .....	6-9
Unit Sections .....	6-10

### 20 Series

Design Data .....	6-6
Detailed Product Descriptions .....	6-14
Unit Sections .....	6-15

### 25 Series

Design Data .....	6-6
Detailed Product Descriptions .....	6-17
Unit Sections .....	6-18

# RADIUS SHAPE WINDOWS

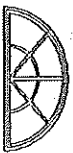

## Product Summary



ThermaStar by Pella® radius shape windows feature an extruded, rigid PVC (polyvinyl chloride) frame and sash with heat-fused mitered corners for a fully welded corner assembly. ThermaStar by Pella windows are available in white and almond.

ThermaStar by Pella radius shape windows meet industry standards for water infiltration and wind resistance, and meet ENERGY STAR® guidelines with Low-E glass.

### 10 Series—New Construction Frame with Nailing Fin Matches Sliding and Single-Hung Window Profile

Our new construction frame features a standard continuous fin, adding a protective weather barrier to the frame and allowing for hassle-free installation.

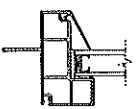

1-5/8" Wall Depth

### 10 Series—New Construction Frame with Nailing Fin and J-Channel Matches Sliding and Single-Hung Window Profile

Our new construction frame features a standard continuous fin, adding a protective weather barrier to the frame and allowing for hassle-free installation. The built-in J-Channel with our brickmould profile makes the sliding installation easy and eliminates the need for exterior trim.

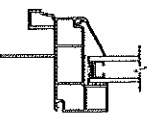

1-5/8" Wall Depth

### 20 Series—Replacement Frame Matches Double-Hung Profile

Our Replacement frame is designed specifically for replacement application for easy installation.

The replacement unit simply slides into the existing sash "pocket" created when the old sashes are removed.

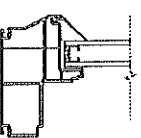

3-1/4" Frame

### 25 Series—New Construction Frame with Nailing Fin and J-Channel Matches Double-Hung Profile

Our new construction frame features a standard continuous fin, adding a protective weather barrier to the frame itself and allowing for hassle-free installation. The built-in J-Channel with our brickmould profile makes the sliding installation friendly and eliminates the need for exterior trim.

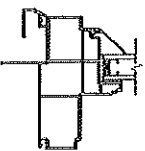

2-9/16" Wall Depth



# RADIUS SHAPE WINDOWS

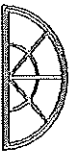

Product Selection Guide  
Size and Performance Data  
Features and Options



## Size and Performance Data

	10 Series	20 Series	25 Series
<b>Sizes</b>			
Standard Sizes	●	●	●
Special Sizes Available Built on 1/8" Increments	●	●	●
<b>Frames</b>			
Nail Fin for 1-5/8" Wall Depth	0	—	—
Nail Fin with J-Channel for 1-5/8" Wall Depth	0	—	—
Nail Fin with J-Channel for 2-9/16" Wall Depth	—	—	5
Replacement Frame for 3-1/4" Frame Depth	—	5	—
Interior primed wood jamb extensions	0	—	0

## Performance

	F-R35-R50	F-R35-R50	F-R35-R50
Meets or Exceeds AAMA/WDMA Ratings			
Air Infiltration (Grvfr of frame @ 1.57 psf wind pressure)	0.30	0.30	0.30
Design Pressure	35-50 psf	35-50 psf	35-50 psf
Water Resistance	4.5 psf	4.5 psf	4.5 psf

(1) Published performance data is for single unit only. See Design Data pages in this section for specific product performance class and grade values.

## Features and Options

	10 Series	20 Series	25 Series
<b>Glazing</b> (6/4" Insulating Glass)			
Clear	5	5	5
Low-E	0	0	0
Argon-Filled Low-E <sup>2</sup>	0	0	0
Bronze Air-Filled Low-E <sup>2</sup>	0	0	0
Obscure	0	0	0
Tempered Safety Glass	0	0	0
<b>Interior/Exterior Color</b>			
White	5	5	5
Almond	0	0	0
<b>Grilles-Between-the-Glass</b>			
<b>Grille Profile</b>			
3/4" Contour	0	0	0
1" Contour	0	0	0
<b>Grille Patterns</b>			
Colonial	0	0	0
Sunburst	0	0	0
Starburst	0	0	0

S = Standard; O = Optional

# RADIUS SHAPE WINDOWS

## Glazing Performance

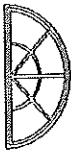

Type of Glazing	U-Factor					Solar Heat Gain Coefficient					% Visible Light Transmission					Meets U.S. ENERGY STAR Performance Criteria in Region Shown		
	10 Series	20 Series	25 Series	40 Series	20 Series	25 Series	40 Series	25 Series	40 Series	25 Series	40 Series	25 Series	N	NC	SC	S		
<b>3/4" CLEAR IG</b>																		
3/4" Clear IG	0.49	0.47	0.47	0.48	0.48	0.61	0.61	0.61	0.61	0.61	0.61	61	61	61				
with 3/4" Contour Grille	0.49	0.47	0.47	0.47	0.51	0.55	0.55	0.55	0.55	0.55	0.55	65	57	57				
<b>3/4" OBSCURE / CLEAR IG</b>																		
3/4" Obscure / Clear IG	0.49	0.48	0.48	0.48	0.51	0.55	0.55	0.55	0.55	0.55	0.55	65	57	57				
with 3/4" Contour Grille	0.49	0.47	0.47	0.47	0.61	0.55	0.55	0.55	0.55	0.55	0.55	65	57	57				
<b>3/4" LOW-E IG</b>																		
3/4" Low-E IG	0.33	0.32	0.32	0.32	0.30	0.30	0.30	0.30	0.30	0.30	0.30	62	54	54				
with 3/4" Contour Grille	0.33	0.32	0.32	0.32	0.30	0.30	0.30	0.30	0.30	0.30	0.30	56	49	49				
<b>3/4" ARGON-FILLED LOW-E IG</b>																		
3/4" Argon-Filled Low-E IG	0.29	0.29	0.29	0.29	0.28	0.28	0.28	0.28	0.28	0.28	0.28	62	54	54				
with 3/4" Contour Grille	0.29	0.29	0.29	0.29	0.32	0.30	0.30	0.30	0.30	0.30	0.30	56	49	49				
<b>3/4" BRONZE LOW-E IG</b>																		
3/4" Bronze Low-E IG	0.33	0.32	0.32	0.32	0.30	0.30	0.30	0.30	0.30	0.30	0.30	62	49	49				
with 3/4" Contour Grille	0.33	0.32	0.32	0.32	0.28	0.28	0.28	0.28	0.28	0.28	0.28	56	36	36				
<b>3/4" BRONZE AIR-FILLED LOW-E IG</b>																		
3/4" Bronze Air-Filled Low-E IG	0.29	0.29	0.29	0.29	0.32	0.30	0.30	0.30	0.30	0.30	0.30	62	49	49				
with 3/4" Contour Grille	0.29	0.29	0.29	0.29	0.32	0.28	0.28	0.28	0.28	0.28	0.28	56	36	36				

(1) Glazing performance values are calculated based on NFRC 100.  
 (2) Climate Zones: N = Northern, NC = North/Central, SC = South/Central, S = Southern.  
 For more information, see the Energy Star guidelines.

R-value = 1/U-Factor

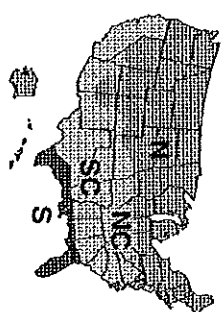

# RADIUS SHAPE WINDOWS

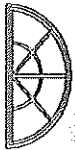

Grille Types



## Grille Profiles

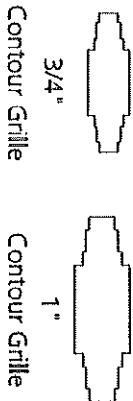

## Grille Configuration Options

### Colonial

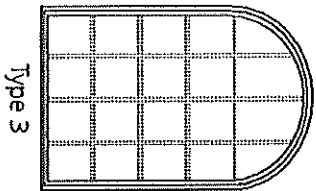

Type 3

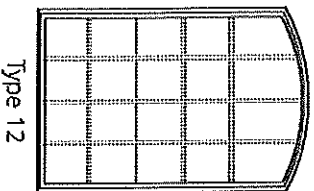

Type 12

### Colonial

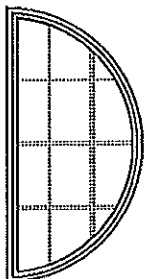

Type 1

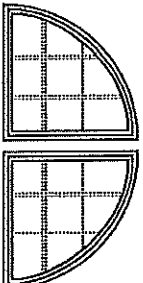

Type 2

### Sunburst

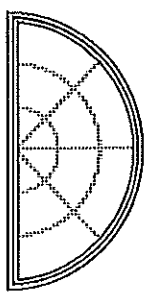

Type 1

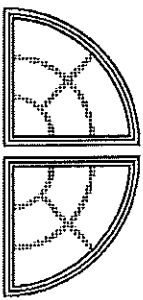

Type 2

### Full Circles

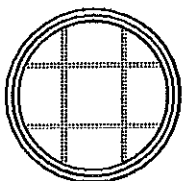

Type 16

### Starburst

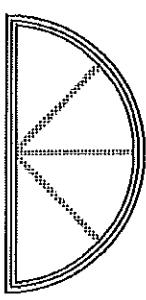

Type 1

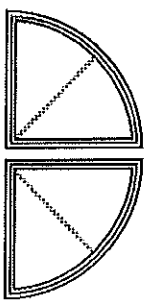

Type 2

### Contour Grilles

### Colonial

### Starburst

### Sunburst

Half Circle

•

•

•

Quarter Circle

•

•

•

Round Top

•

—

—

Arch Head

•

—

—

Full Circle

•

—

—

• = Available in 3/4" or 1" profiles.

# RADIUS SHAPE WINDOWS



Radius Shapes



Key:  
 FH = Frame Height  
 FW = Frame Width  
 SSH = Straight Side Height  
 FR = Frame Rise

		FORMULAS
 Half Circle	MINIMUM	$FH = (FW/2) - 1/4$
	MAXIMUM	
 Quarter Circle	MINIMUM	$\text{RADIUS} = FW/2$ $SSH = FH - R$
	MAXIMUM	
 Round Top	MINIMUM	$FR = FH - SSH$
	MAXIMUM	
 Arch Head	MINIMUM	$\text{RADIUS} = (FW + (4 \times FR)) / (8 \times FH)$ Minimum Radius = 14.574" Maximum Radius = 239.374" $FR = FH - SSH$
	MAXIMUM	
 Full Circle	MINIMUM	
	MAXIMUM	

- Both width and height cannot be > than 73-1/2" .
- Maximum Square Foot = 40 ft².
- Bronze glass is limited to 22 ft².
- If long side is ≤ 95-1/2" , width and height ratio ≤ 8:1.
- If long side is > 95-1/2" , width and height ratio < 5:1.
- Minimum overall width plus overall height is 29" .
- Maximum frame width with 9-Lite Prairie grille = 72" .
- If glass width/height ratio is > 5:1, then glass must be tempered.
- Tempered glass must measure > 18-1/2" diagonally.
- To convert areas to square meters (m²), multiply square feet by 0.0929.

# RADIUS SHAPE WINDOWS



10 Series, 20 Series and 25 Series  
Sunburst Grilles  
Size Table



Scale 1/8" = 1'-0"

## Half Circles

Opening 2' 8"	(813) (800)	Opening 3' 0"	(814) (802)	Opening 3' 4"	(1 016) (1 023)	Opening 4' 0"	(1 219) (1 207)
Frame 3'1 1/2"		Frame 3'5 1/2"		Frame 3'9 1/2"		Frame 4'7 1/2"	
1' 4"	(406) (394)	1' 6"	(457) (445)	1' 8"	(508) (496)	2'-0"	(610) (597)
2'-9 1/2"		3'-2 1/2"		3'-5 1/2"		4'-11 1/2"	
Opening 3' 0"	(1 524) (1 511)	Opening 5' 0"	(1 828) (1 815)				
Frame 5'9 1/2"		Frame 7'1 1/2"					
2' 6"	(762) (749)	3' 0"	(814) (802)				
2'9 1/2"		3'5 1/2"					

## Quarter Circles

Opening 2' 0"	(910) (897)	Opening 2' 4"	(711) (699)	Opening 2' 8"	(813) (800)
Frame 2'3 1/2"		Frame 2'7 1/2"		Frame 3'1 1/2"	
2' 0"	(910) (897)	2' 4"	(711) (699)	2' 8"	(813) (800)
2'3 1/2"		2'7 1/2"		3'1 1/2"	
Left		Left		Left	
Right		Right		Right	
Opening 3' 0"	(914) (892)	Opening 3' 6"	(1 015) (1 003)	Opening 3' 8"	(1 015) (1 003)
Frame 3'5 1/2"		Frame 3'9 1/2"		Frame 3'9 1/2"	
3' 0"	(914) (892)	3' 6"	(1 016) (1 003)	3' 8"	(1 016) (1 003)
3'5 1/2"		3'9 1/2"		3'9 1/2"	
Left		Left		Left	
Right		Right		Right	

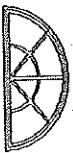
**RADIUS SHAPE WINDOWS**

10 Series  
Design Data

**Half Circle**

Unit	Frame	Performance	
Width (Inches)	Height (Inches)	Class & Grade	
2-8/1-4	31-1/2	15-1/2	F-HC50
3-0/1-8	35-1/2	17-1/2	F-HC50
3-4/1-8	39-1/2	19-1/2	F-HC50
4-0/2-0	47-1/2	23-1/2	F-HC50
5-0/2-6	59-1/2	29-1/2	F-HC50
6-0/3-0	71-1/2	35-1/2	F-HC50

**Quarter Circle**

Unit	Frame	Performance	
Width (Inches)	Height (Inches)	Class & Grade	
2-0/2-0	23-1/2	23-1/2	F-HC50
2-8/2-4	27-1/2	27-1/2	F-HC50
2-8/2-8	31-1/2	31-1/2	F-HC50
3-0/3-0	35-1/2	35-1/2	F-HC50
3-4/3-4	39-1/2	39-1/2	F-HC50

To convert areas to square meters (m<sup>2</sup>), multiply square feet by 0.0929

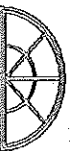
**RADIUS SHAPE WINDOWS**
**10 Series  
Detailed Product Descriptions**
**Frame**

- Wall depth is 1-5/8" for an overall frame depth of 2-3/4".
- Frame members are extruded rigid PVC.
- Frame members are mitered and heat-fused to provide a fully welded corner assembly.
- Frame includes a continuous integral nailing fin (with brickmould profile J-Channel).

**Glazing System**

- Quality float glass complying with ASTM C 1036.
- Exterior face-glazed 3/4" sealed insulating glass.
- [Clear] [Low-E coated] [Argon-filled, multilayer Low-E coated] [Bronze air-filled, multilayer Low-E coated] [Obscure].
- Tempered glazing also available.

**Interior/Exterior Finish**

- All window frame members have an integral color extruded throughout the profiles.
- All exposed PVC surfaces are smooth, glossy and uniform in appearance.
- Colors are [white] [almond].

**Optional Products**

- Grilles-Between-the-Glass
  - Insulating glass contains [3/4"] [1"] contoured aluminum grilles permanently installed between two panes of glass.
  - Grilles match color of interior and exterior frame.
- Factory applied primed wood jamb extension for [4-9/16"] [6-9/16"] wall depth.

# RADIUS SHAPE WINDOWS



10 Series  
Nailing Fin  
Unit Sections

Scale 6" = 1'-0"

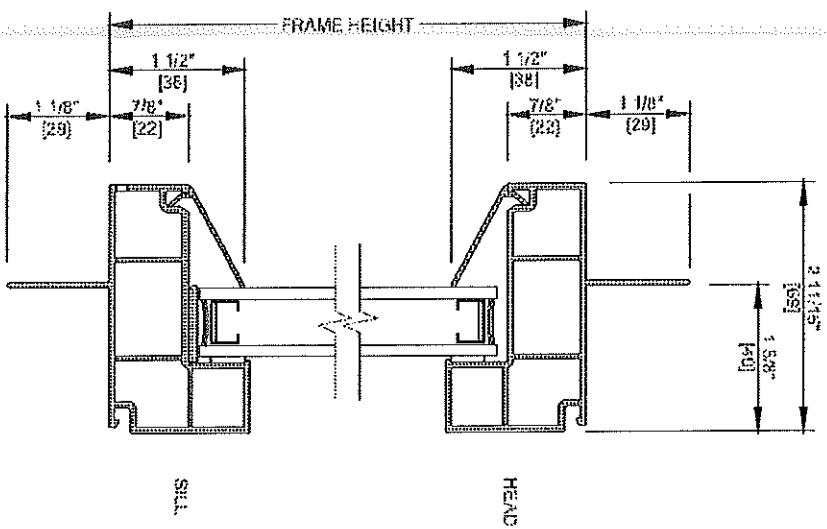

LAMBS

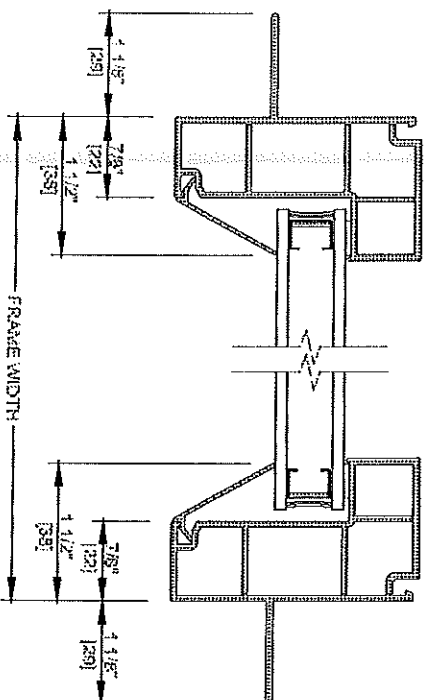

All dimensions are approximate.



# RADIUS SHAPE WINDOWS

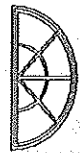

10 Series  
Nailing Fin  
Unit Sections

Scale 3" = 1'-0"

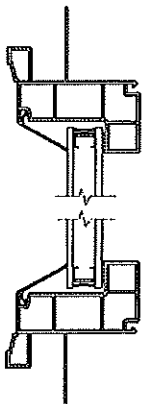
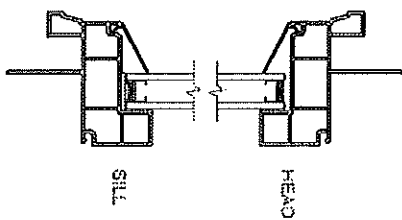

Units with Optional Factory Applied Wood Jamb Extensions

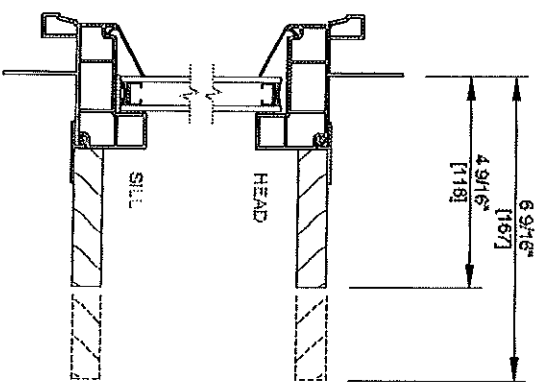
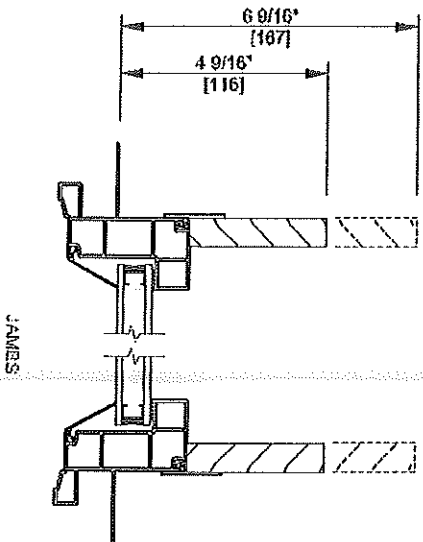

# RADIUS SHAPE WINDOWS

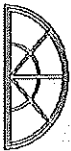

## 10 Series Nailing Fin and J-Channel Unit Sections

Scale 6" = 1'-0"

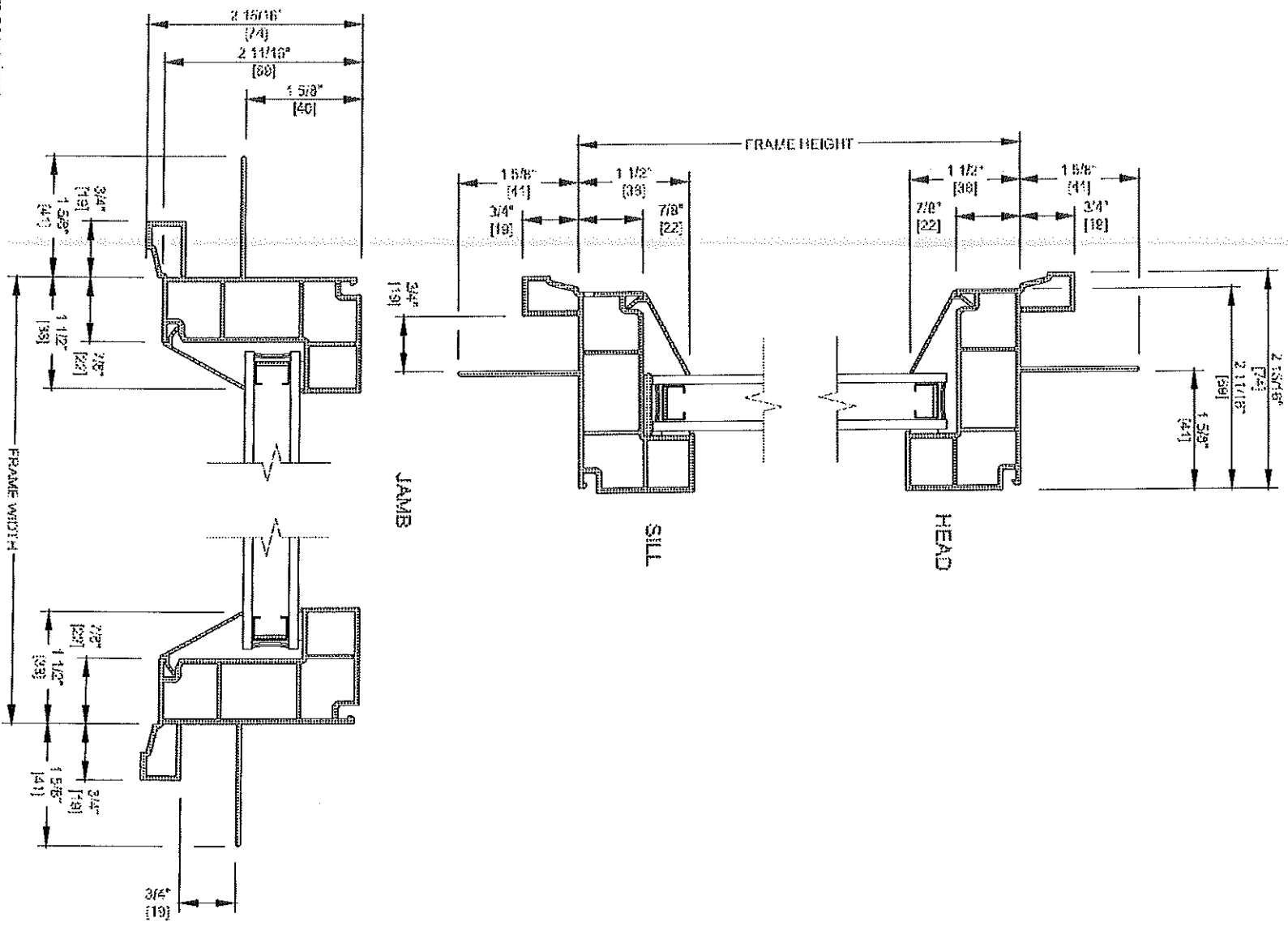

All dimensions are approximate.

# RADIUS SHAPE WINDOWS



10 Series  
Nailing Fin and J-Channel  
Unit Sections

Scale 3" = 1'-0"

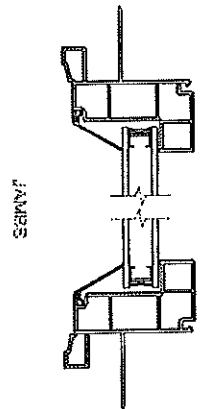
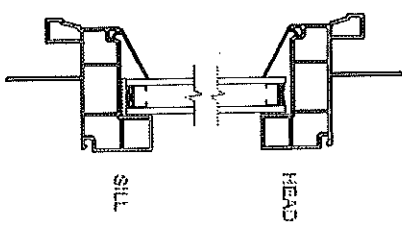

Units with Optional Factory Applied Wood Jamb Extensions

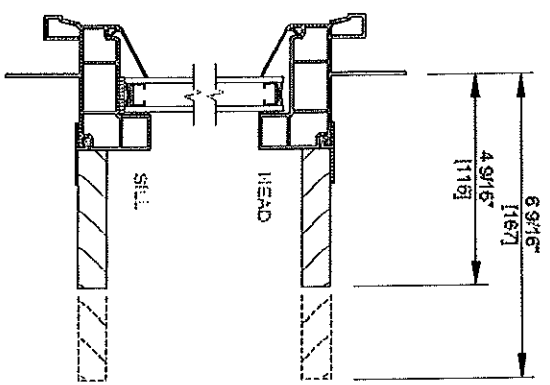
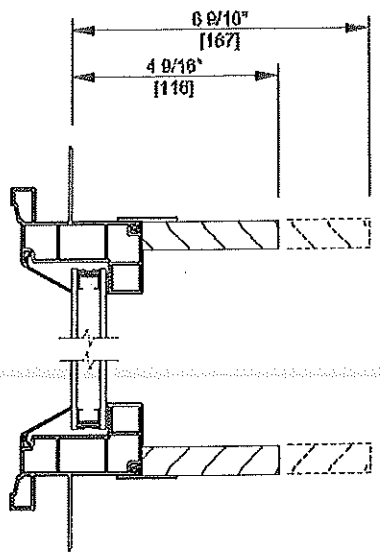

**RADIUS SHAPE WINDOWS**
**20 Series**  
**Detailed Product Descriptions**

**Replacement Frame**

- Overall frame depth is 3-1/4" .
- Frame members are extruded rigid PVC.
- Frame members are mitered and heat-fused to provide a fully welded corner assembly.

**Glazing System**

- Quality float glass complying with ASTM C 1036.
- Exterior face-glazed 3/4" sealed insulating glass.
- [Clear] [Low-E coated] [Argon-filled, multilayer Low-E coated] [Bronze air-filled, multilayer Low-E coated] [Obscure].
- Tempered glazing also available.

**Interior/Exterior Finish**

- All window frame members have an integral color extruded throughout the profiles.
- All exposed PVC surfaces are smooth, glossy and uniform in appearance.
- Colors are [white] [almond].

**Optional Products**

- Grilles-Between-the-Glass
  - Insulating glass contains [3/4"] [1" ] contoured aluminum grilles permanently installed between two panes of glass.
  - Grilles match color of interior and exterior frame.

# RADIUS SHAPE WINDOWS

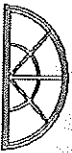

20 Series  
Unit Sections

Scale 6" = 1'-0"

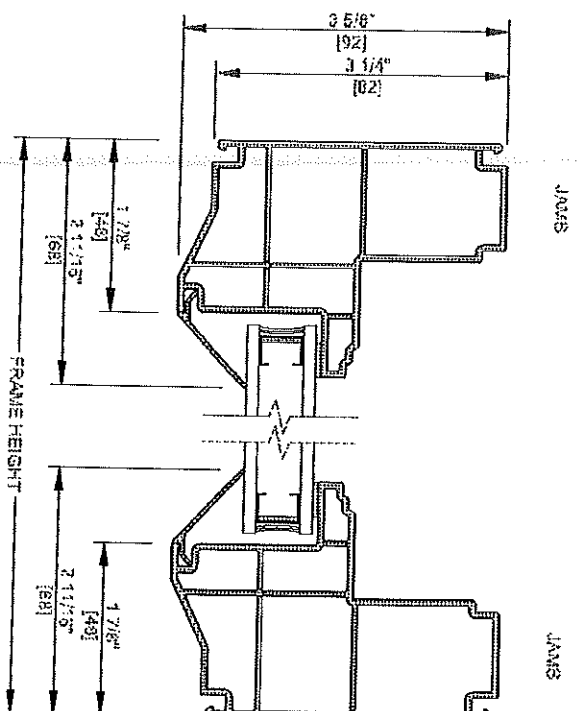
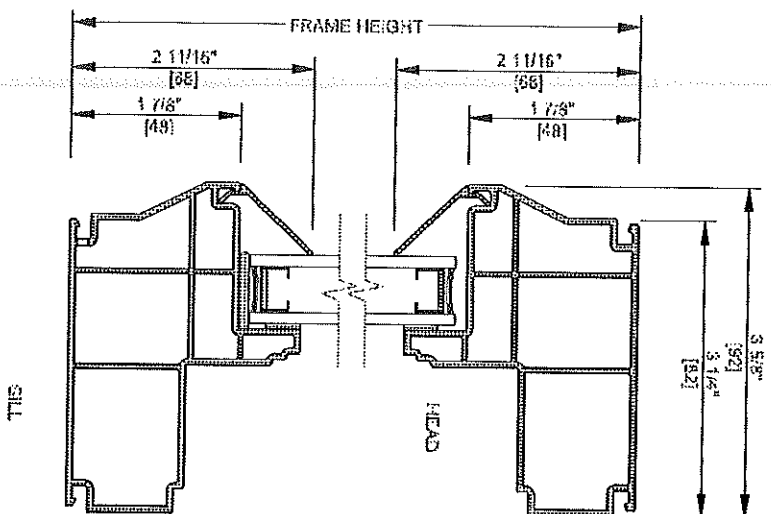

All dimensions are approximate.

# RADIUS SHAPE WINDOWS



20 Series  
Unit Sections

Scale 3" = 1'-0"

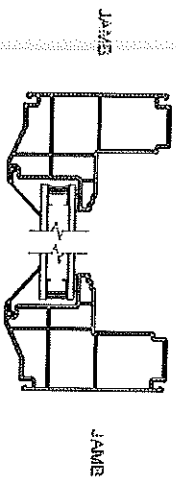
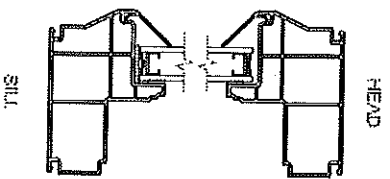

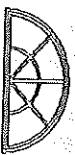
**RADIUS SHAPE WINDOWS**
**25 Series**  
**Detailed Product Descriptions**
**Frame**

- Wall depth is 2-9/16" for an overall frame depth of 4-3/16".
- Frame members are extruded, rigid PVC.
- Frame members are mitered and heat-fused to provide a fully welded corner assembly.
- Frame includes a continuous nailing fin and brickmould shape J-Channel.

**Glazing System**

- Quality float glass complying with ASTM C 1036.
- Exterior face-glazed 3/4" sealed insulating glass.
- [Clear] [Low-E coated] [Argon-filled, multilayer Low-E coated] [Bronze air-filled, multilayer Low-E coated] [Obscure].
- Tempered glazing also available.

**Interior/Exterior Finish**

- All window frame members have an integral color extruded throughout the profiles.
- All exposed PVC surfaces are smooth, glossy and uniform in appearance.
- Colors are [White] [almond].

**Optional Products**

- Grilles-Between-the-Glass
  - Insulating glass contains [3/4"] [1"] contoured aluminum grilles permanently installed between two panes of glass.
  - Grilles match color of interior and exterior frame.
- Factory applied primed wood jamb extension for [4-9/16"] [6-5/16"] wall depth.