

City of Portland, Maine - Building or Use Permit Application

389 Congress Street, 04101 Tel: (207) 874-8703, Fax: (207) 874-8716

Permit No:	04-0347	Issue Date:	PERMIT	CBL:	315 A001001
------------	---------	-------------	--------	------	-------------

Location of Construction: 659 Warren Ave
 Business Name: Maines Floorcovering

Owner Address: 659 Warren Ave
 Contractor Address: P.O. Box 3271 Auburn
 Permit Type: Commercial

Owner Name: Maines Floorcovering
 Contractor Name: Randy Akers
 Phone: [blank]
 Phone: [blank]
 Phone: 2077828764
 Type: 34

Past Use: Commercial
 Proposed Use: Commercial/ After the fact building permit, 6 temporary structures for warehouse
 FIRE DEPT: \$291.00
 Cost of Work: \$30,000.00
 CEO District: 5
 INSPECTION: [blank]
 Use Group: [blank]
 Type: [blank]

Proposed Project Description: 6 temporary structures for warehousing.
 Signature: [Handwritten Signature]
 Signature: [blank]
 Action: Approved Approved w/Conditions Denied
 Signature: [blank]
 Date: [blank]

Permit Taken By: Idobson
 Date Applied For: 04/02/2004
Zoning Approval

- This permit application does not preclude the Applicant(s) from meeting applicable State and Federal Rules.
- Building permits do not include plumbing, septic or electrical work.
- Building permits are void if work is not started within six (6) months of the date of issuance. False information may invalidate a building permit and stop all work.

Special Zone or Reviews	Zoning Appeal	Historic Preservation
<input type="checkbox"/> Shoreland <input type="checkbox"/> Wetland <input type="checkbox"/> Flood Zone <input type="checkbox"/> Subdivision <input type="checkbox"/> Site Plan <input type="checkbox"/> Major <input type="checkbox"/> Minor <input type="checkbox"/> MAM <input type="checkbox"/> [blank]	<input type="checkbox"/> Variance <input type="checkbox"/> Miscellaneous <input type="checkbox"/> Conditional Use <input checked="" type="checkbox"/> Interpretation <input type="checkbox"/> Approved <input type="checkbox"/> Denied	<input type="checkbox"/> Not in District or Landmark <input type="checkbox"/> Does Not Require Review <input type="checkbox"/> Requires Review <input type="checkbox"/> Approved <input type="checkbox"/> Approved w/Conditions <input type="checkbox"/> Denied
[Handwritten: NE Site, Flood, Approved for A permit, NE Site, Approved, Date: 4/2/04]	[Handwritten: Approved]	[Handwritten: Approved]

CERTIFICATION

I hereby certify that I am the owner of record of the named property, or that the proposed work is authorized by the owner of record and that I have been authorized by the owner to make this application as his authorized agent and I agree to conform to all applicable laws of this jurisdiction. In addition, if a permit for work described in the application is issued, I certify that the code official's authorized representative shall have the authority to enter all areas covered by such permit at any reasonable hour to enforce the provision of the code(s) applicable to such permit.

SIGNATURE OF APPLICANT _____ ADDRESS _____ DATE _____ PHONE _____

RESPONSIBLE PERSON IN CHARGE OF WORK TITLE _____ DATE _____ PHONE _____



Commercial Building Permit Application

If you or the property owner owes real estate or personal property taxes or user charges on any property within the City, payment arrangements must be made before permits of any kind are accepted.

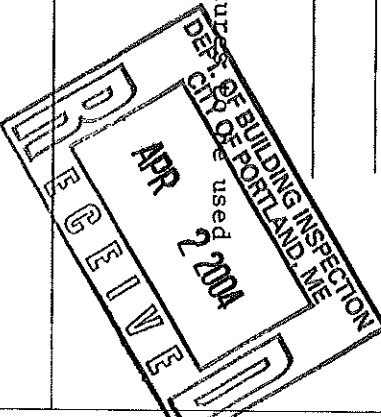
Location/Address of Construction: 659 Warren Avenue		Square Footage of Lot 193,171 s.f.	
Total Square Footage of Proposed Structure 6 Structures @ 2200 s.f.		Telephone: (207)782-8769	
Tax Assessor's Chart, Block & Lot Chart# 315 Block# A Lot# 1	Owner: Maine's Floor Covering Super Store, LLC	Cost Of Work \$ 30,000	
Lessee/Buyer's Name (If Applicable) N/A	Applicant name, address & telephone: Randy Akers c/o AHJ Marketing P.O. Box 3271 Auburn, ME 04212	Fee: \$ 291.00	
Current Specific use: Warehouse/Retail			
Proposed Specific use: Warehouse/Retail			
Project description: After the fact building permit for 6 temporary tent structures for warehousing.			
			
Contractor's name, address & telephone: N/A		Who should we contract when the permit is ready: Randy Akers	
Mailing address: P.O. Box 3271 Auburn, Maine 04212		Phone: 782-8764	

Please submit all of the information outlined in the Residential Application Checklist. Failure to do so will result in the automatic denial of your permit.

At the discretion of the Planning and Development Department, additional information may be required prior to permit approval. For further information stop by the Building Inspections office, room 315 City Hall or call 874-8703.

I hereby certify that I am the Owner of record of the named property, or that the owner of record authorizes the proposed work and that I have been authorized by the owner to make this application as his/her authorized agent. I agree to conform to all applicable laws of this jurisdiction. In addition, if a permit for work described in this application is issued, I certify that the Code Official's authorized representative shall have the authority to enter all areas covered by this permit at any reasonable hour to enforce the provisions of the codes applicable to this permit.

Signature of applicant: [Signature] Date: 3/22/04

Permit Fee: \$30.00 for the first \$1000.00 Construction Cost, \$9.00 per additional \$1000.00 cost

This is not a Permit; you may not commence any work until the Permit is issued.



Commercial Building Permit Application Checklist

All of the following information is required and must be submitted in order to help insure an expeditious permitting process.

A Complete Set of construction drawings must include:

Note: Construction documents for construction in excess of \$50,000.00 must be prepared by a Design Professional and bear their seal.

- Cross sections w/framing details
- Detail of any new walls or permanent partitions
- Floor Plans & Elevations
- Window and door schedules N/A
- Foundation plans with required drainage and damp proofing (if applicable) N/A
- Electrical and plumbing layout. Mechanical drawings for any specialized equipment such as furnaces, chimneys, gas equipment, HVAC equipment (air handling) or other types of work that may require special review must be included. N/A

315A1

Separate permits are required for internal & external plumbing, HVAC, and electrical installations.

If there are any additions to the footprint or volume of the new or existing structure(s), a plot plan is required and must include:

- The shape and dimension of the lot, footprint of the proposed structure and the distance from the actual property lines drawn to scale. Structures include decks, porches; a bow windows cantilever sections and roof overhangs, sheds, pools, garages and any other accessory structures must be shown.
- Boundary survey to scale showing North arrow; zoning district and setbacks.
- First floor sill elevation (based on mean sea level datum) N/A
- Location and dimensions of parking areas and driveways
- Location and size of both existing utilities in the street and the proposed utilities serving the building
- Location of areas on the site that will be used to dispose of surface water.
- Existing and proposed grade contours
- Silt fence locations N/A

Surveyor's monuments must be in place and the lot staked for a setback inspection.

Please submit all of the information outlined in this Commercial Application Checklist. Failure to do so will result in the automatic denial of your permit.

At the discretion of the Planning and Development Department, additional information may be required prior to permit approval. For further information stop by the Building Inspections office, room 315 City Hall or call 874-8703.

Permit Fee: \$30.00 for the first \$1000.00 Construction Cost, \$9.00 per additional \$1000.00 cost

This is not a Permit; you may not commence any work until the Permit is issued.

KODIAK SHELTER SYSTEMS

A Division of JANICE MANUFACTURING INC
616 Dufferin Avenue, Selkirk, Manitoba, Canada
Phone 1-800-699-0244 (Toll free), Direct 204-482-2940
Cellular 204-981-1142, Facsimile 204-482-2945

Material Specification

315 A 1

Frame materials are manufactured from Allied Mechanical Tube "Gatorshield" 50/55 which has a minimum yield tensile of 50,000 psi yield and 55,000 psi tensile. Actual sizes used as follows:

- Side base rails 2.375" O.D. with a .095" wall
- Side hoops spaced every 5' minimum use 2.375" O.D. with a .095" wall
- Side hoops are joined together using 2.375" O.D. x .095" crimped to insert into I.D.
- Front & Back base rails use 2.375" O.D. x .095 wall.
- Perlons utilize 1.660" O.D. x .083 wall tubing.
- All 1.660" tube is joined together using 1.660" O.D. tube swaged to insert into I.D.
- Perlons are secured into place using two hole rigid conduit straps at each hoop, front and back hoops are secured by sliding the perlon onto a nipple welded to the union.
- Hoops are connected to the base rail by sliding the hoops onto nipples welded to the base.
- Anchors are used every 5' to secure the structure to the ground. Anchors are made from 1/2" diameter C1018 mild steel, they are 30 inches long and have a 3" diameter flying welded one complete revolution.
- Anchors are secured to the base rail using U-Bolts.
- Covers are made with 12 ounce polyethylene fabric and are secured using diamond braid polyester rope and D-Rings, which are mechanically fastened to the base rail.
- Snow load is approximately 26 lbs per square foot
- Load rating is 300 lbs per hoop.
- For additional information required please contact Kodiak Shelter Systems.

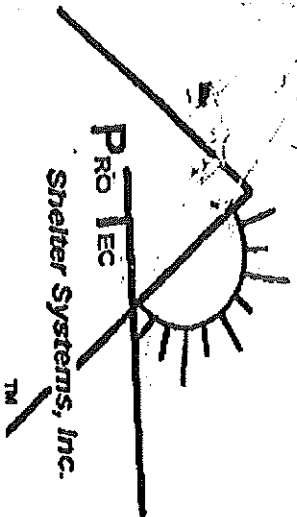

616 Dufferin Avenue
 Selkirk, Manitoba
 Canada R1A 2J2
 TOLL FREE: 1-800-699-0244
 PHONE: 1-204-482-2948
 FAX: 1-204-482-2945

315 A 1

THIS KIT CONTAINS:

CUSTOMER NAME: AHT Marketing INVOICE #: 1267

STYLE: LARGE QUONSET

UNIT: 30 W x 50 L x 15 H

DESCRIPTION	QTY	DESCRIPTION	QTY
2 3/8" CROSS UNION	27 ●	BASE RAILS 2 3/8"	6 ● 144" 20" 48"
2 3/8" END TEE	6 ●	TOP CROSS RAILS 1 3/4"	6 ● 54 1/4"
2 3/8" UNION	8 ●	BOTTOM CROSS RAILS 1 1/4"	6 ●
2 3/8" BUTT UNION	8 ●	BOTTOM CROSS RAILS 1 1/4"	6 ●
1/2" UNION	8 ●	2 3/8" HOOPSIDE & TOP	144 ●
1 1/4" UNION	8 ●	PONY WALL	8 ●
1 11/16" UNION	4 ●	1/4" NYLON ROPE	5/6 ●
D-RINGS	104 ●	SELF-TAPPING SCREWS	300 ● 325 ●
CLIPS	104 ●	ROBERTSON BIT	1 ●
TURNBUCKLES	4 ●	ANCHORS	28 ●
U-BOLTS	8 ●	INSTRUCTIONS:	
SMALL - 1 1/4"	8 ●		
MEDIUM - 1 5/8"	8 ●		
LARGE - 2 3/8"	22 ●		
2-HOLE STRAP	8 ●	OTHER:	
SMALL	8 ●	SEE ATTACHED FOR	
LARGE	8 ●	END WALLS	

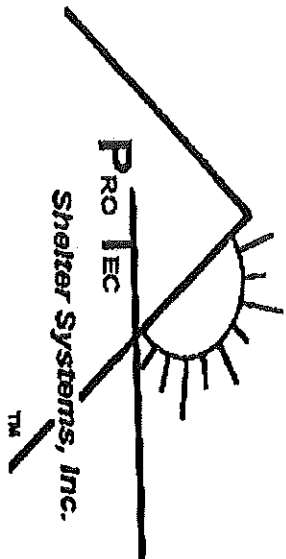

INSTRUCTIONS

Before you begin construction, please read instructions, study diagrams, and check all components to the parts list. By doing so, you will save time and perhaps re-construction.

Any questions can be answered by calling
Pro Tec Shelter Systems, Inc.

1-800-699-0244

NOTE

ANCHORING YOUR SHELTER IS VERY IMPORTANT

All shelters must be anchored to protect what you are covering as well as the area surrounding the shelter.

Frame Installation Instructions

30'-35'-37' Wide Units Multi Length Large Quonset's
42' & 50'

315 A 001

Base Rail Assembly

Using base rail chart, assembly your base rail. Attach all fittings using enclosed screws. Be sure all screw heads are away from tarp so there will not damage to tarp from screw heads rubbing.

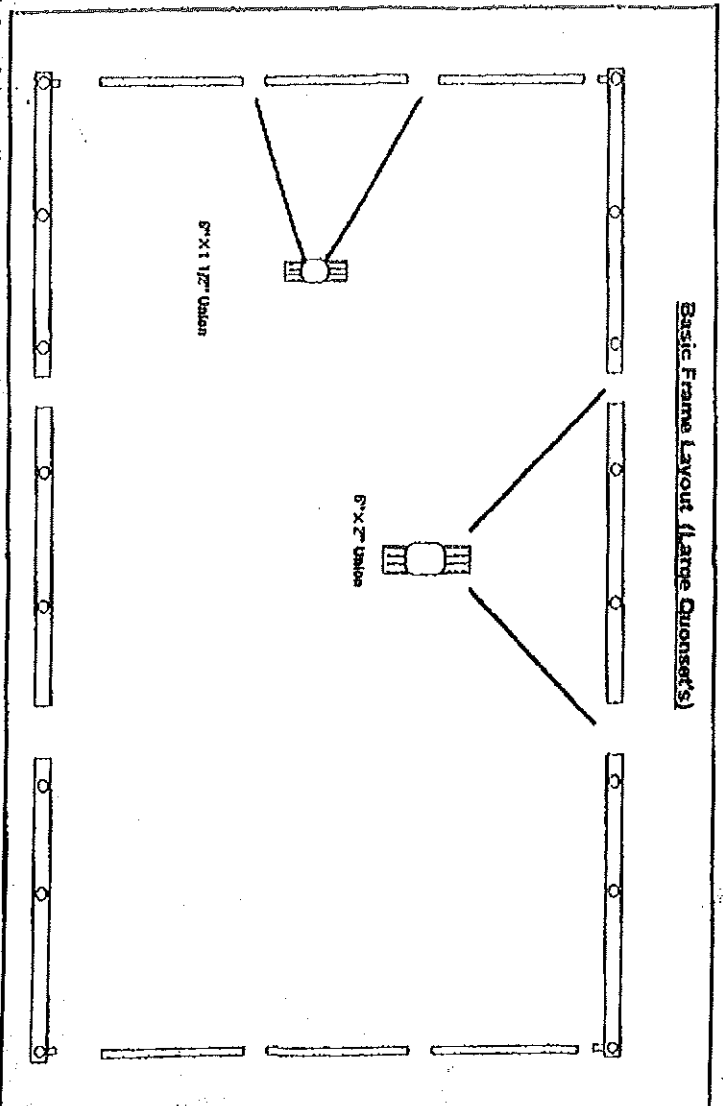

Join side rails with unions. Once side rails are assembled join them together with your front and rear base rails.

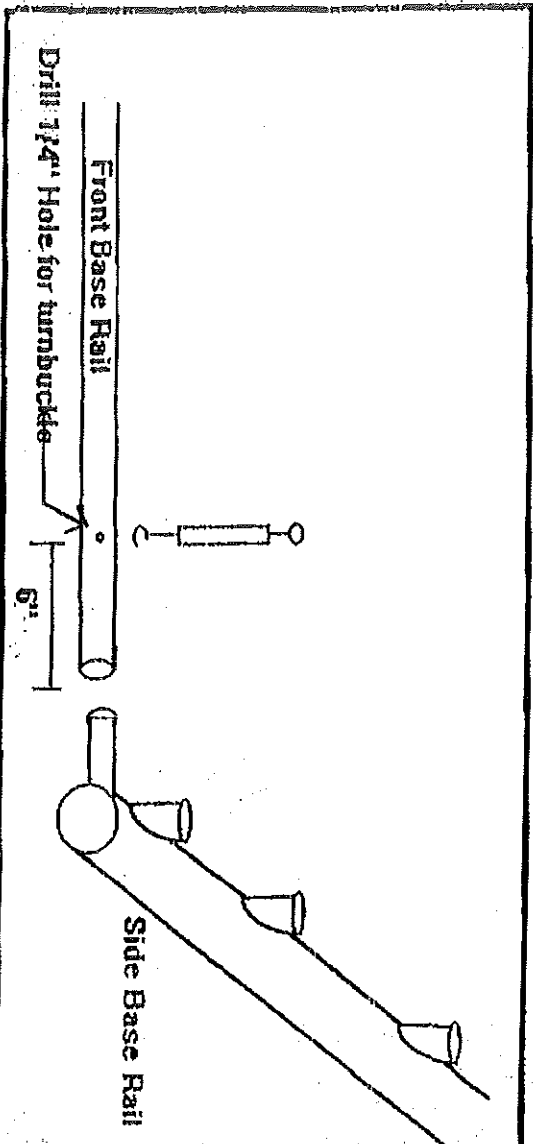

Secure all four corners with supplied screws. Insure frame is square and ready to accept hoops.

Frame Assembly

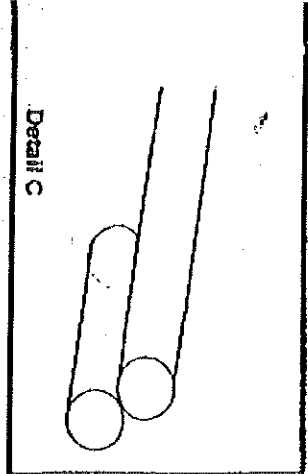
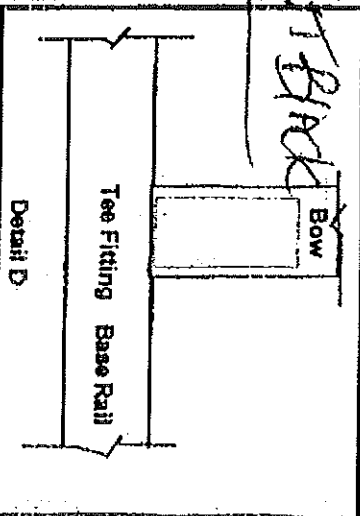
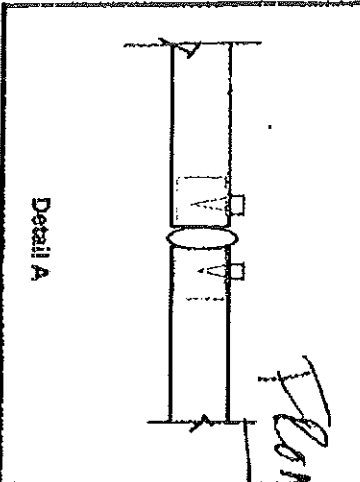
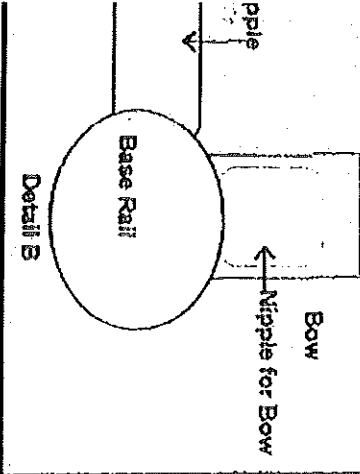
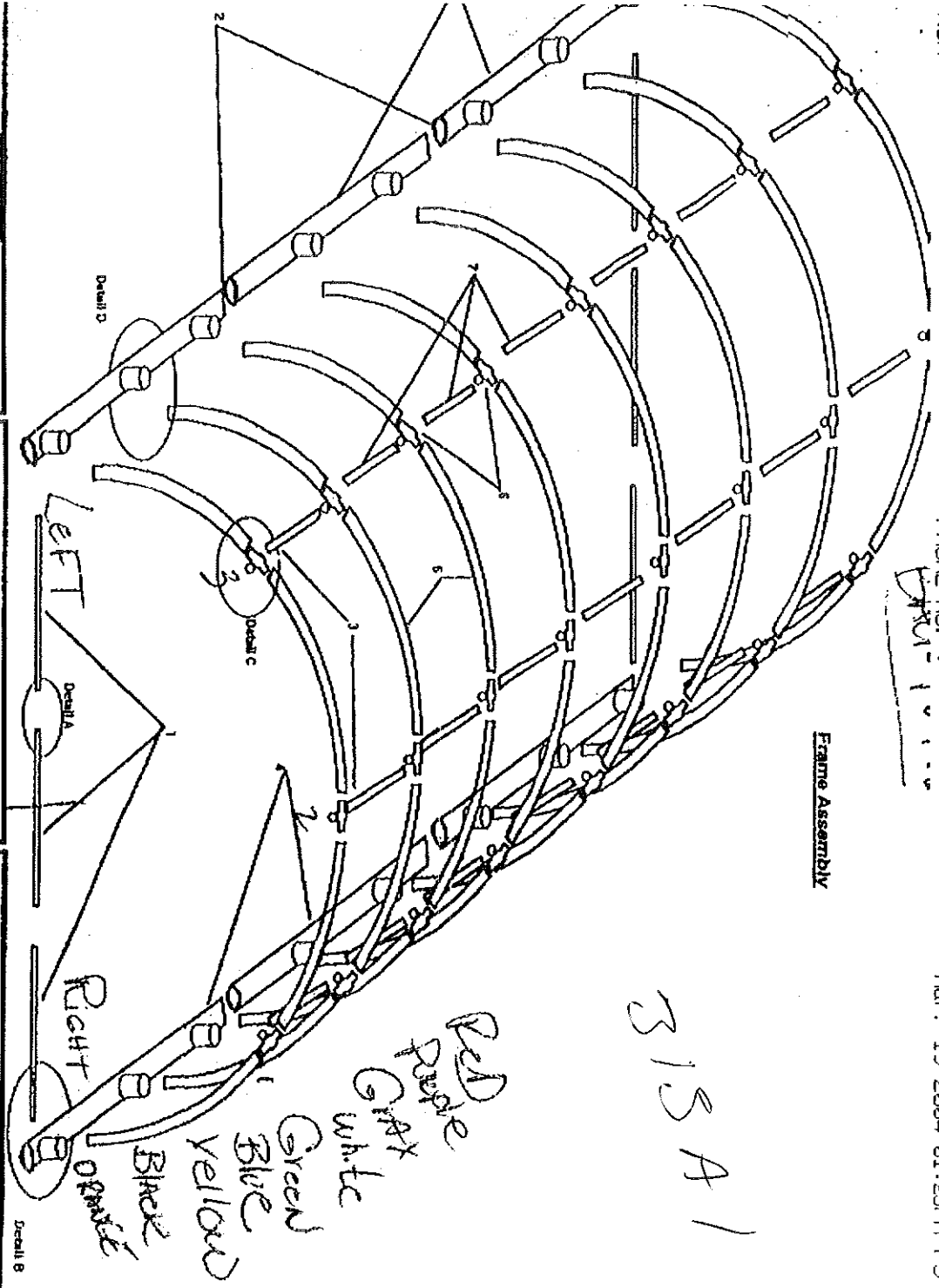

- Diagram Parts List
- | | |
|----------------------|--------------------------|
| #1 Front & Rear Base | #4 Base Rail |
| #2 Joiner Union | #5 Bows |
| #3 End Perions | #6 Tee Fitting |
| | #7 Cross Rails (Purions) |

See following pages for Tee Fitting Installation.

Amendment

Diagram belows show the procedure to instal Pony Wall, if your unit uses this extended height unit. Base rail with complete pony wall should be totally secure, squared and anchored prior to installing the assembled hoop on top of Pony Wall.

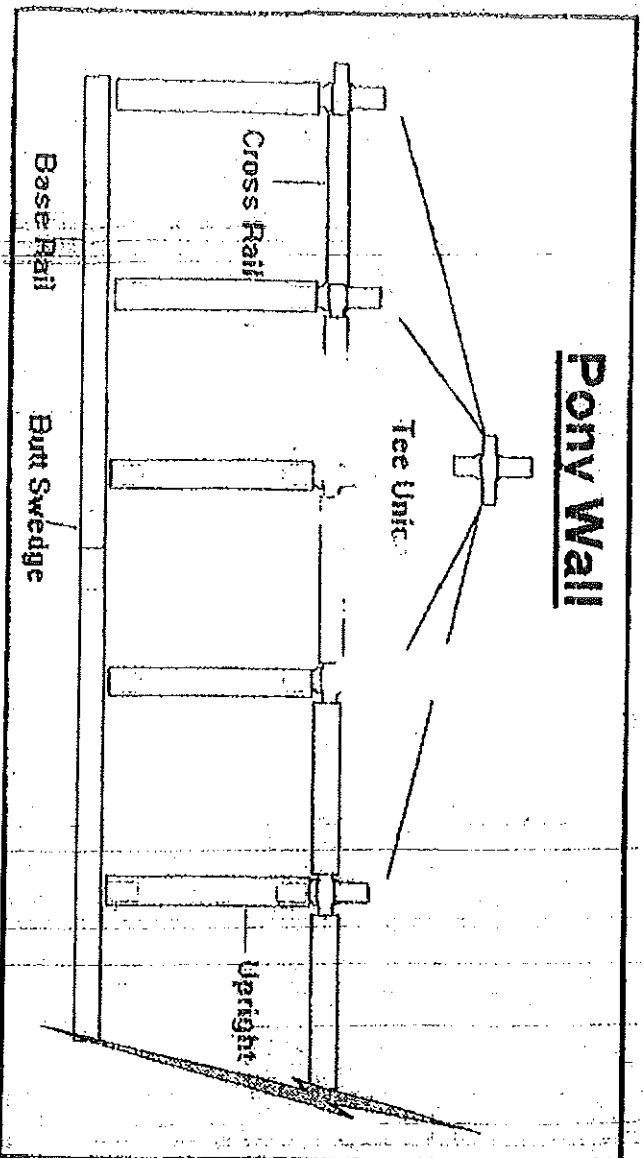

313 A 1

Hoop Assembly and Installation

Taking three or four sections of (#5) depending on the width and height of your unit and join them together with a tee fittings. Insure that all hoops sections are level and tee fittings are square with hoop. Once entire unit is secured with screws it may be lifted as an assembly and mounted on base rail nipples. AS each set of hoops is erected the perions between each set must be installed as per diagrams below

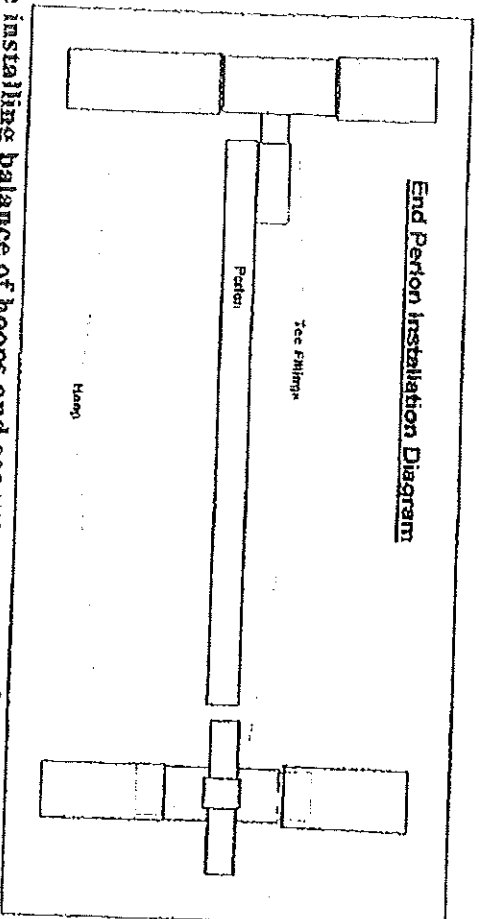
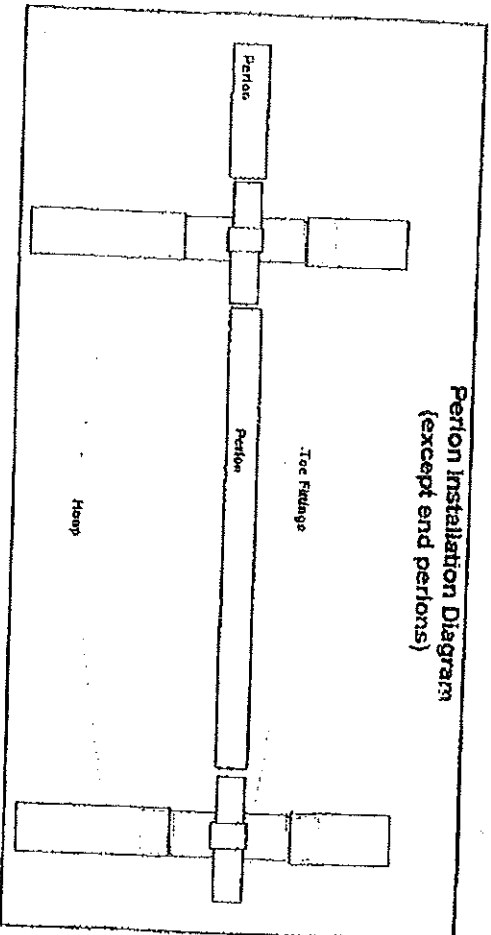

315A

Continue installing balance of hoops and secure as you go. Once all hoops have been secured to base rail, ensure unit is square and all hoops are squared.

Install Anchors

Anchors should be installed in each corner of frame and equally spaced down side base rails depending on the length of your unit. Using a small bar through anchor eyelet twist anchor into ground until top of anchor is app. 2" above ground. Clamp eyelet to frame with supplied u-bolts.

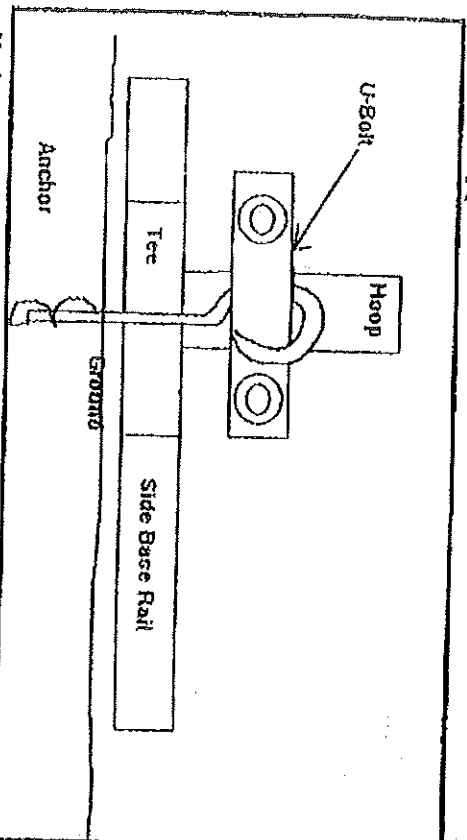

Anchors supplied normally are for dirt, gravel, or grass installation. Anchors for concrete and asphalt are available upon request.

318A1

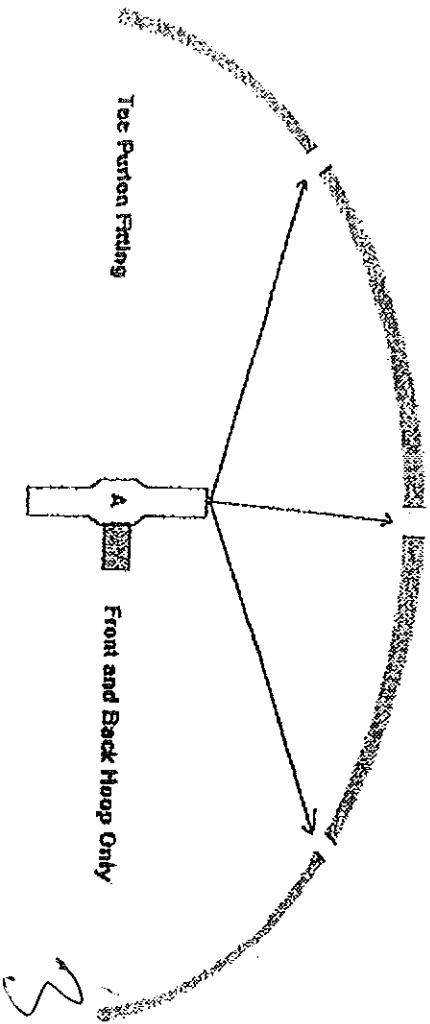
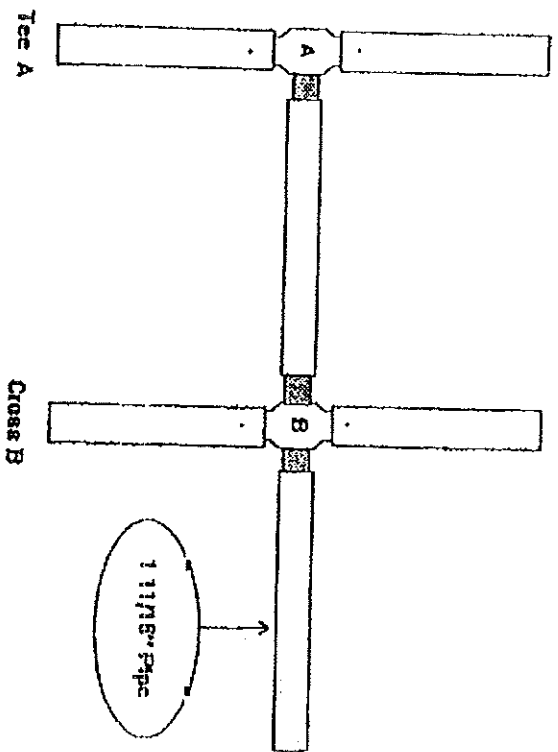
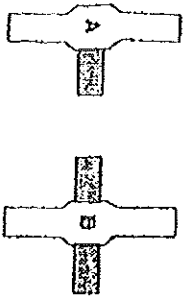

3/5 A 1

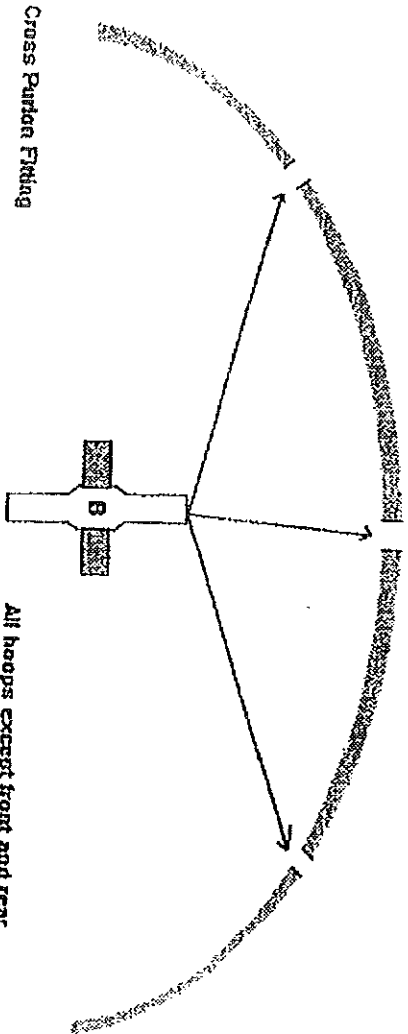

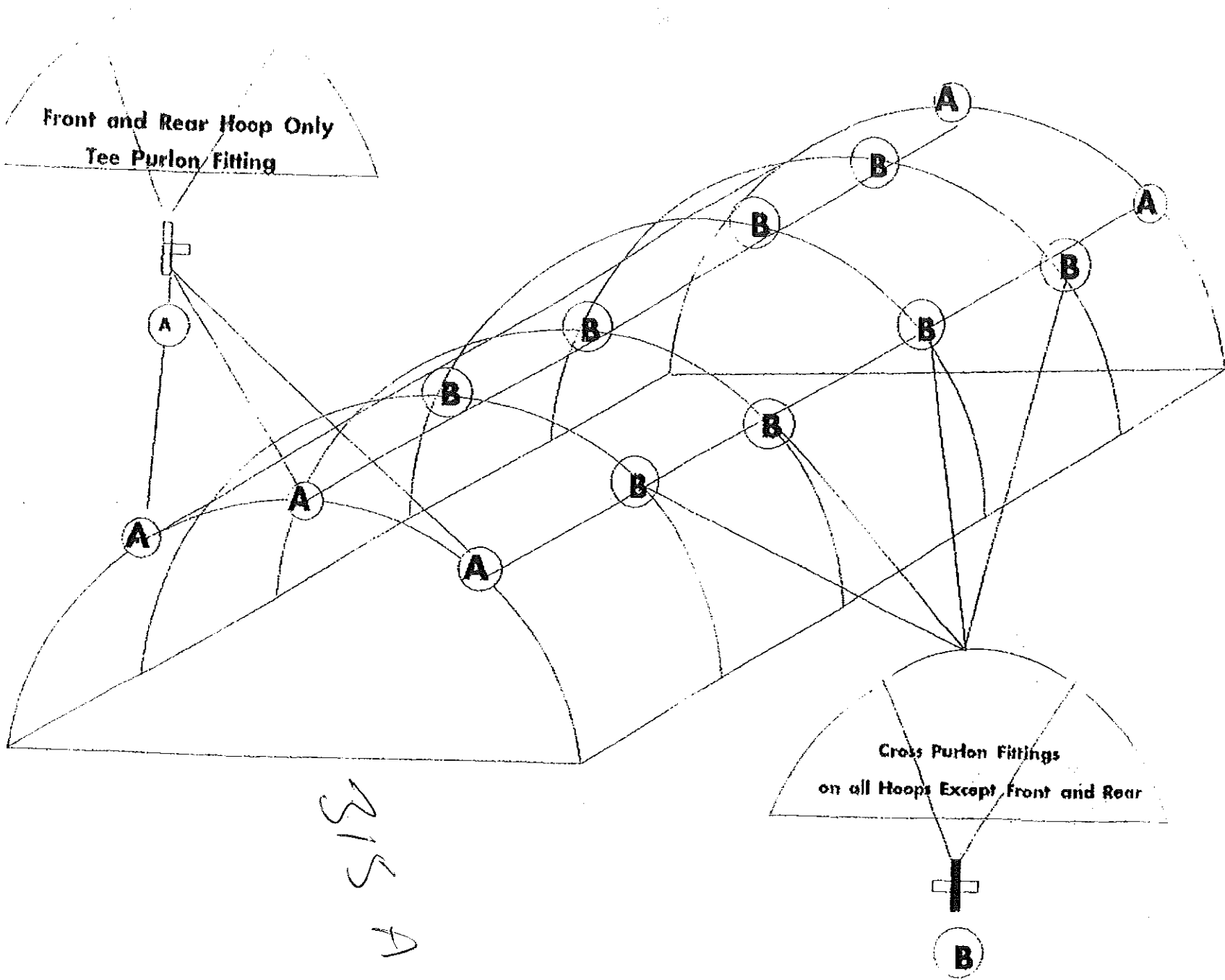

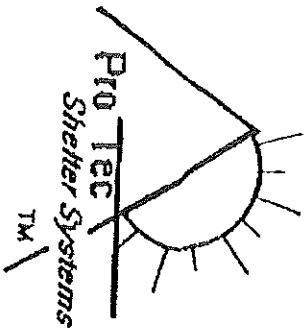

616 Dufferin Avenue
Selkirk, Manitoba
Canada R1A 2J2
1-800-699-0244

Top View

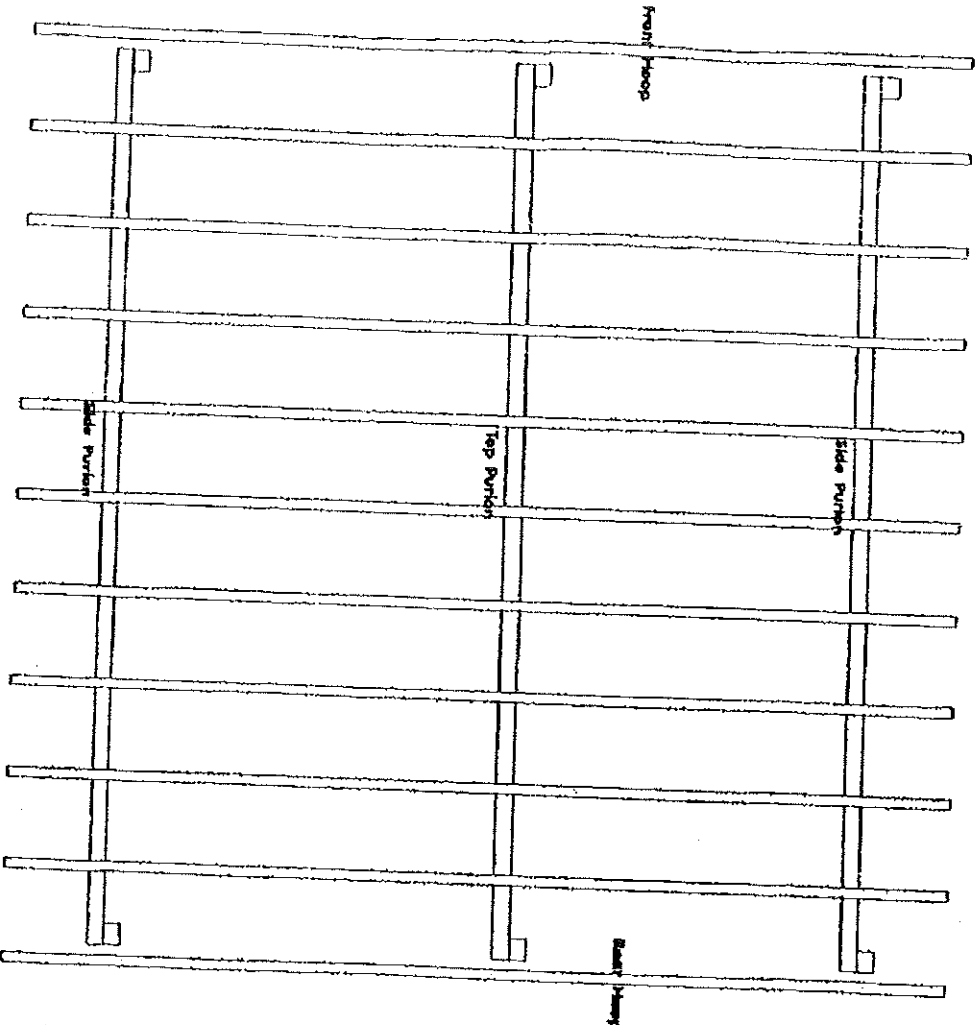

315A1



Front & Rear Purline Only

Center the End Panel in the End Hoop. Lace the Panel to the Hoop as indicated (VIEW L). Attach the D-Rings opposite each Grommet on the inside of the Base Rail. Lace the Panel to through the D-Rings as indicated (VIEW M). Tighten the ropes until the Panel is snug.

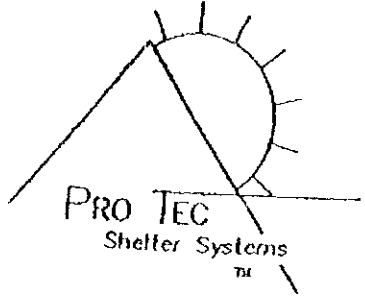

315A1
M

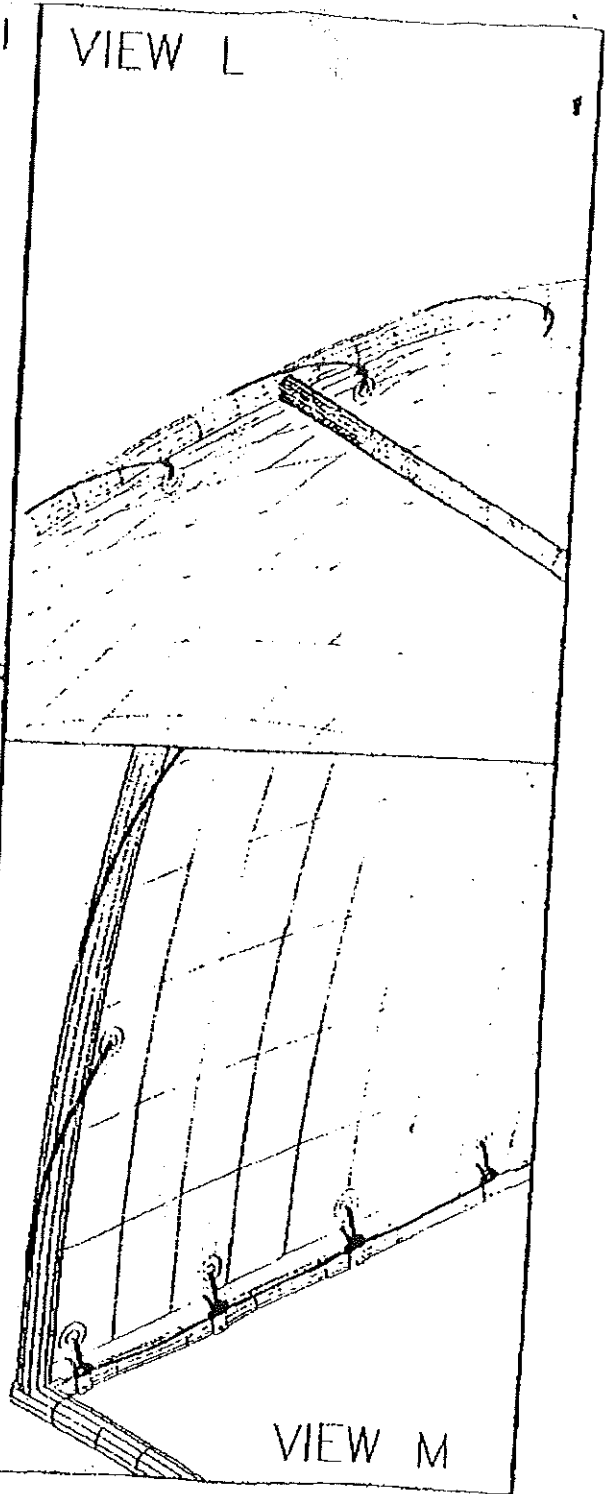
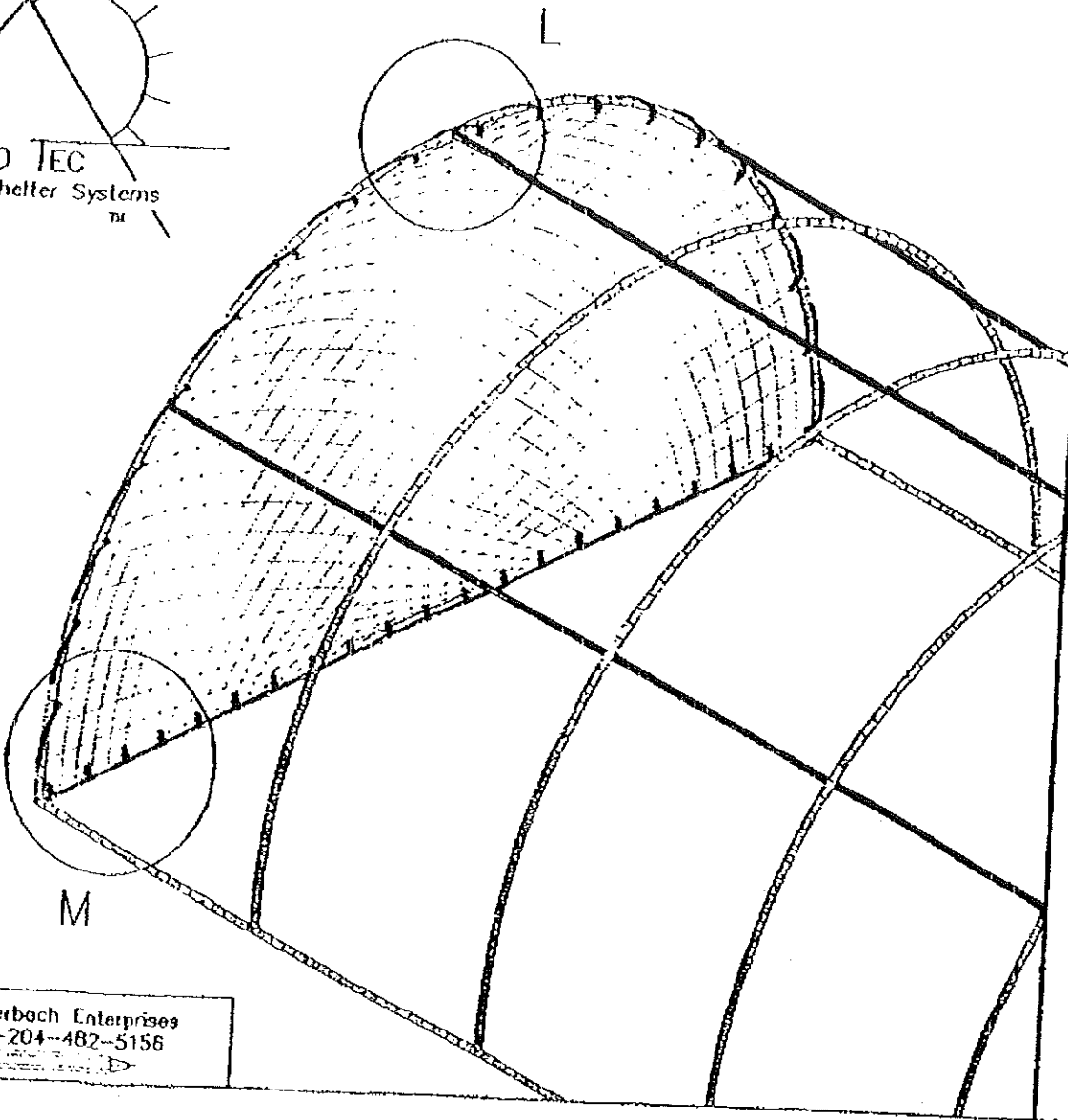

Drawings by Comberbach Enterprises
Saskirk, Mon. 1-204-482-5156

Center the End Panel in the End Hoop. Lace the Panel to the Hoop as indicated (VIEW N). Attach the D-Rings opposite each Grommet on the inside of the Base Rail. Lace the Panel to through the D-Rings as indicated (VIEW O). Tighten the ropes until the Panel is snug. Do not lace or install D-Rings at door way.

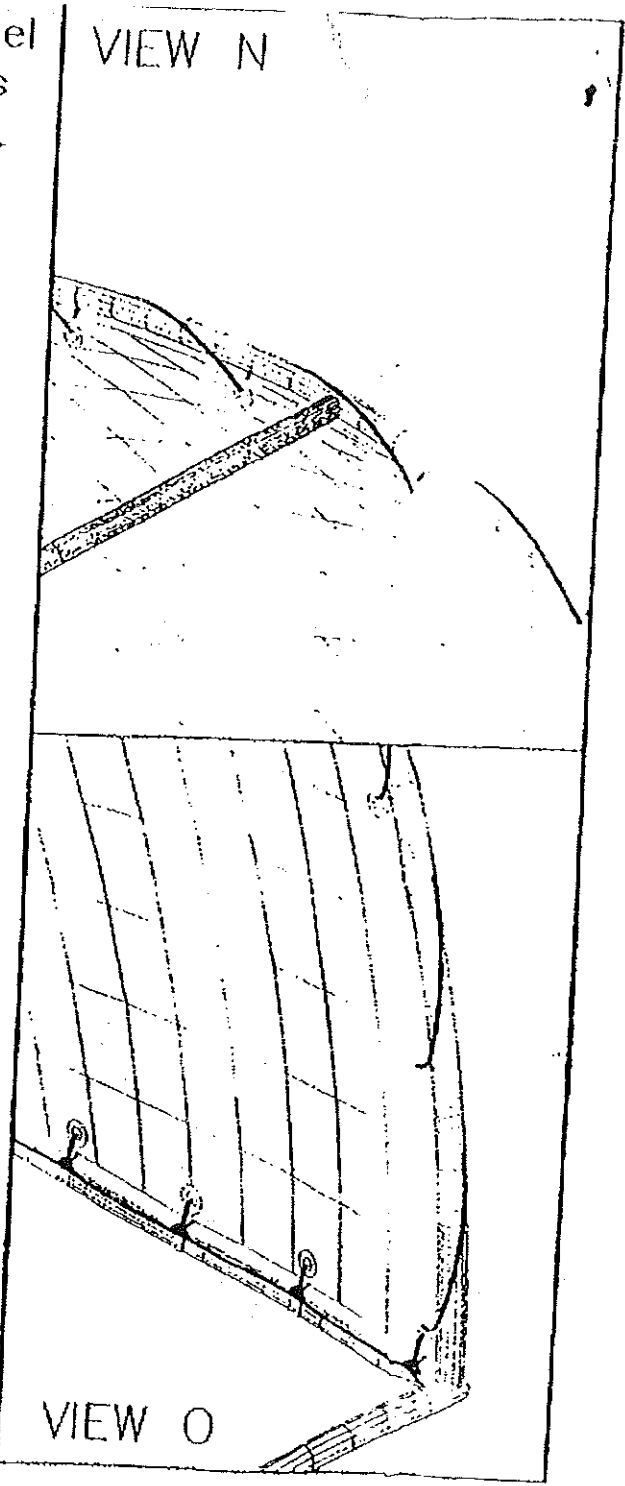
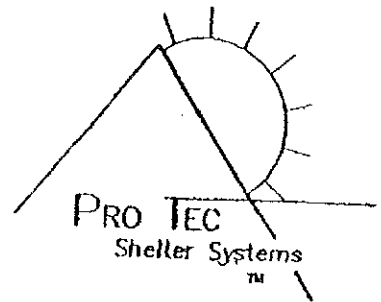
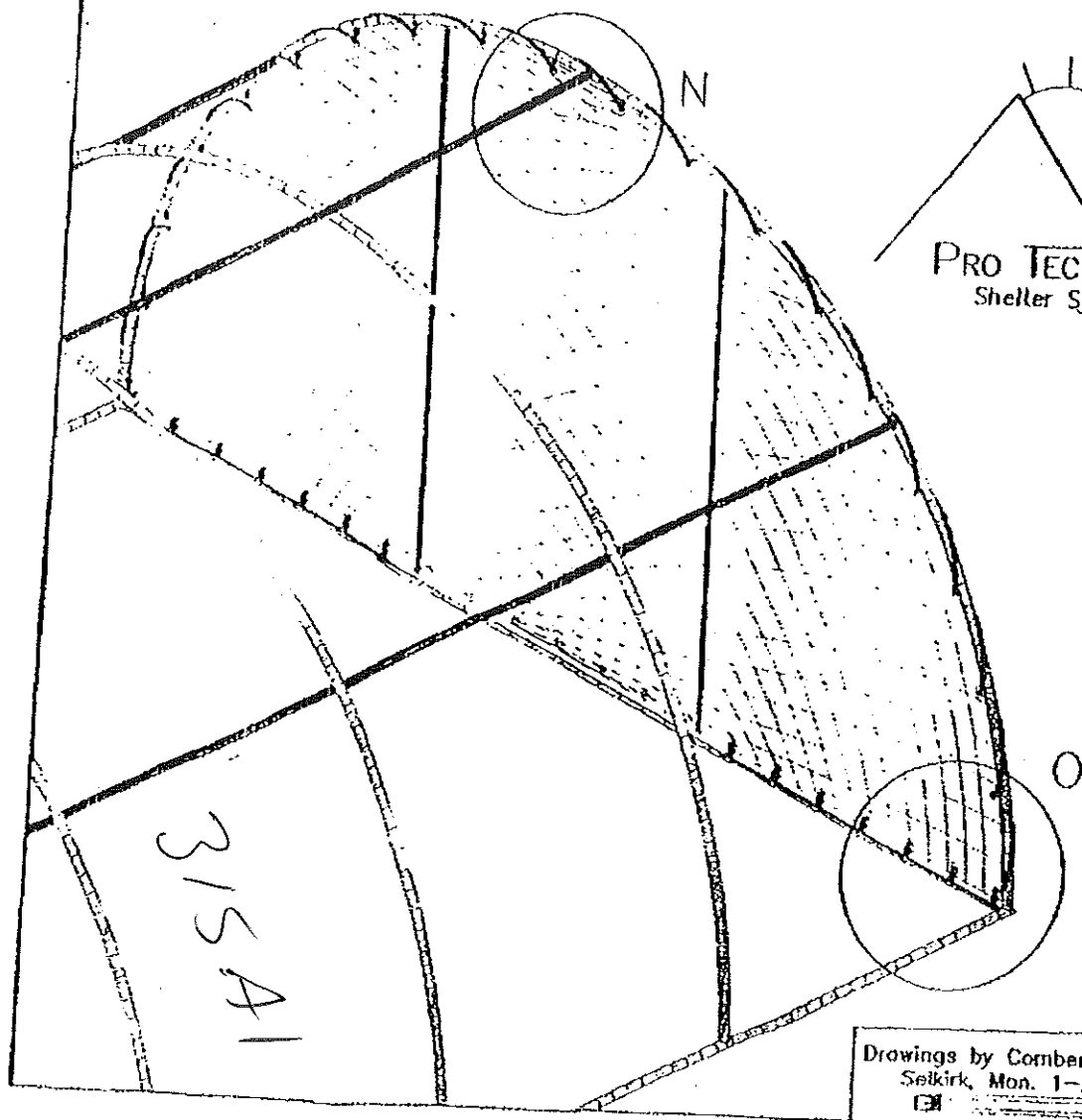

Drawings by Comberbach Enterprises
Saskirk, Mon. 1-204-482-5156

Main Tarp Installation Diagram

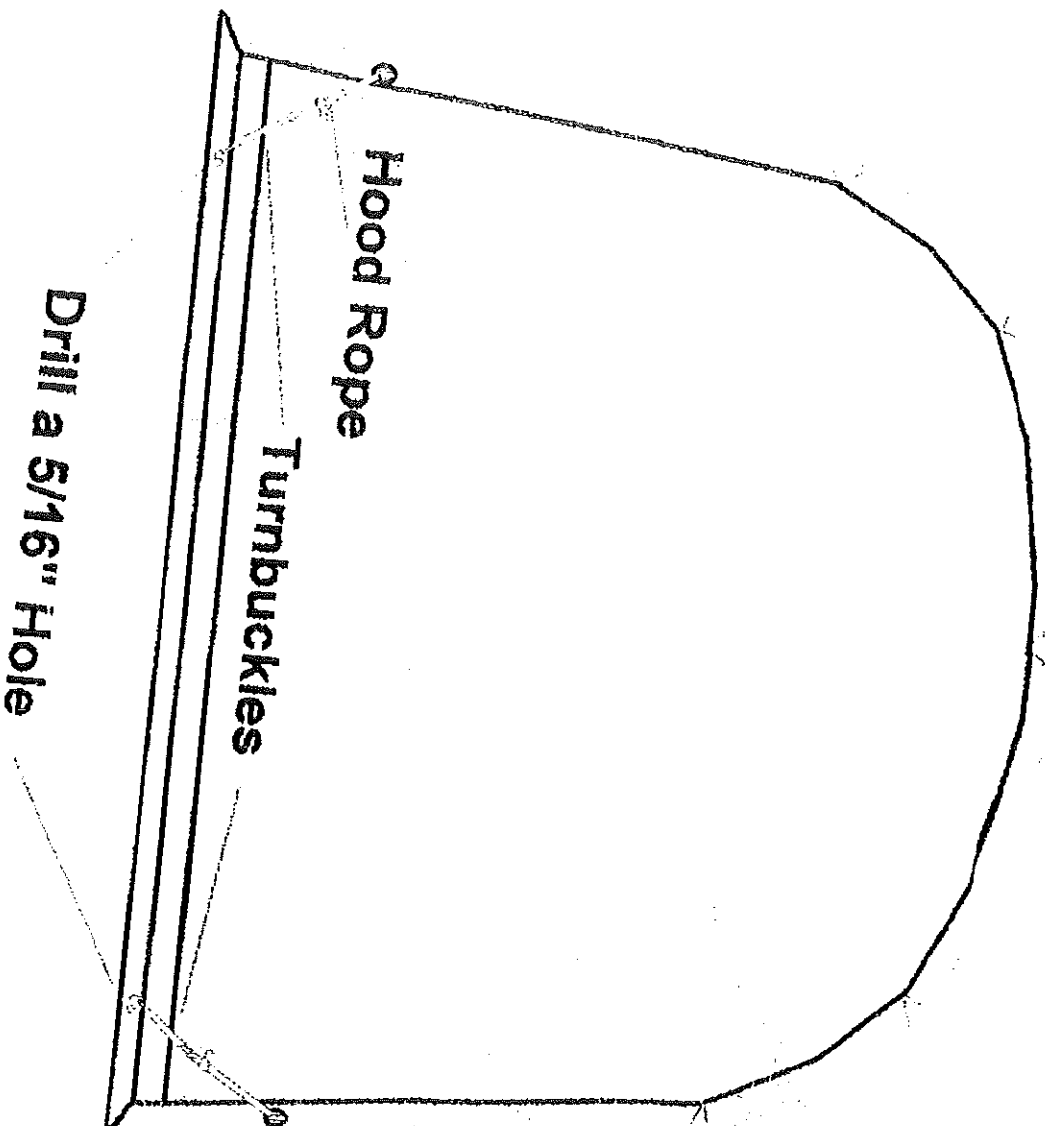

Position Main Tarp onto frame. Insure tarp is level and square with the same amount of hang over at both ends and down both sides. Once this has been done, drill the 5/16" hole in front and rear cross rails to accept the turnbuckles. Slip hoop ropes into turnbuckles on all four corners. Progressively tighten the ropes until you feel main tarp is snug. At this time you should install d-rings inside unit on the side base rails opposite each grommet on main tarp sides. See diagram on following page.

315A1

Main Tarp Installation - Diagram 2

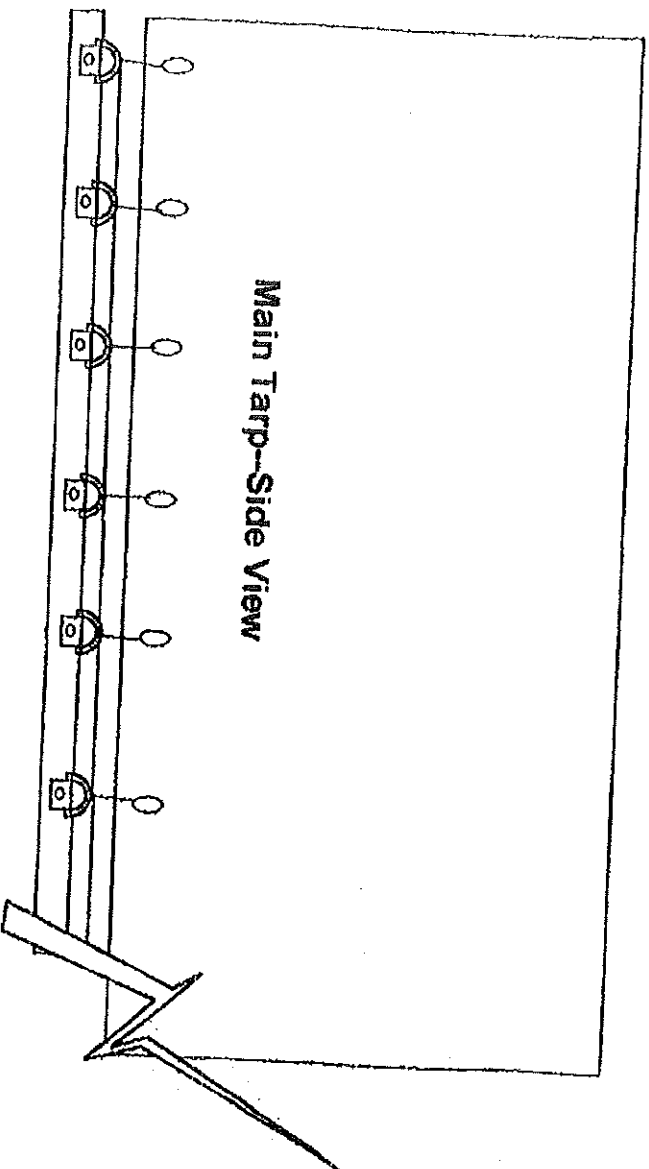

Lace side's of main tarp as indicated. Continue to adjust one side then the other until the desired tension is reached.

It is advisable to continue to adjust and re-tighten all ropes as necessary with a new installation.

318A1

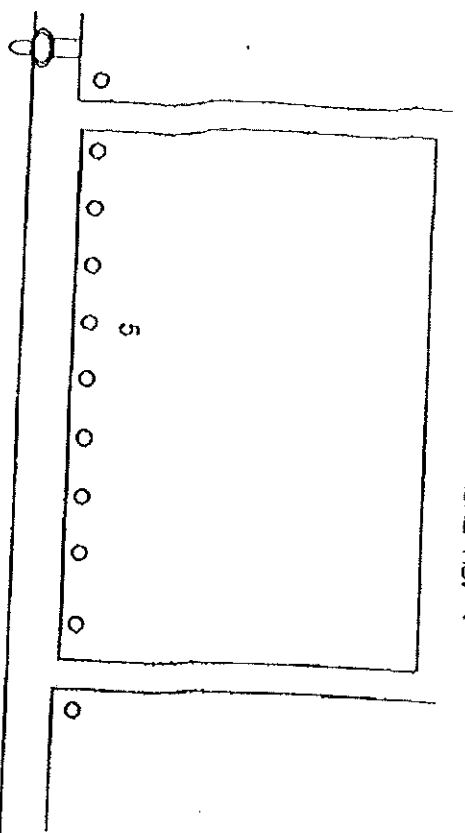

Union 1

Roll Up Door Installation

1. Pipe's attach to bottom of #5 Zippered Panel.
2. U-Joint
3. Handle Extension
4. Crank Handle
5. Zippered Panel (entry)

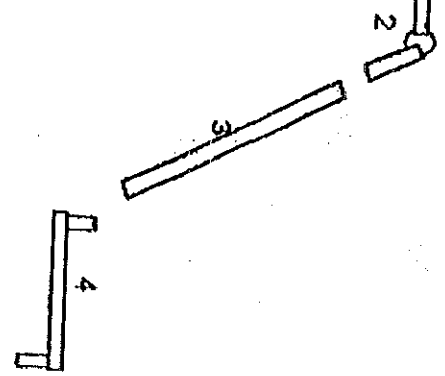

Attach #1 pipe to bottom of #5 using screws and washers.
 Slip U-Joint onto end and attach with screws.
 Attach Handle extension to u-joint with screws.
 Attach Crank Handle to Handle extension.

#1 pipe should extend past zippered tarp on both sides app. 12".
 This overlap is used to anchor roll up door to ground.

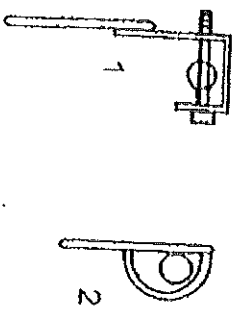

Install above brackets with lags into concrete 6" outside door opening. These brackets are used to anchor roll up door mechanism. Bracket 2 goes on the side without the crank handle. When door in down slip end of pipe into this bracket. Slip crank end into bracket 1 and secure with a bolt thru bracket and pipe.

315A1

MAIN COVER HOOD & WEB
END FRAME FOR FABRIC DOOR

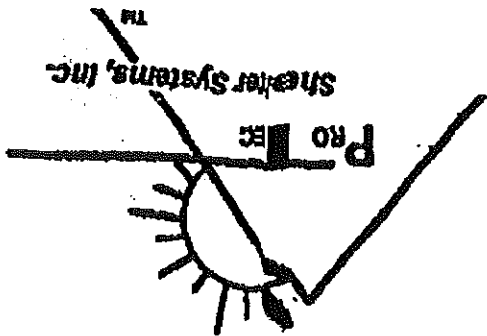
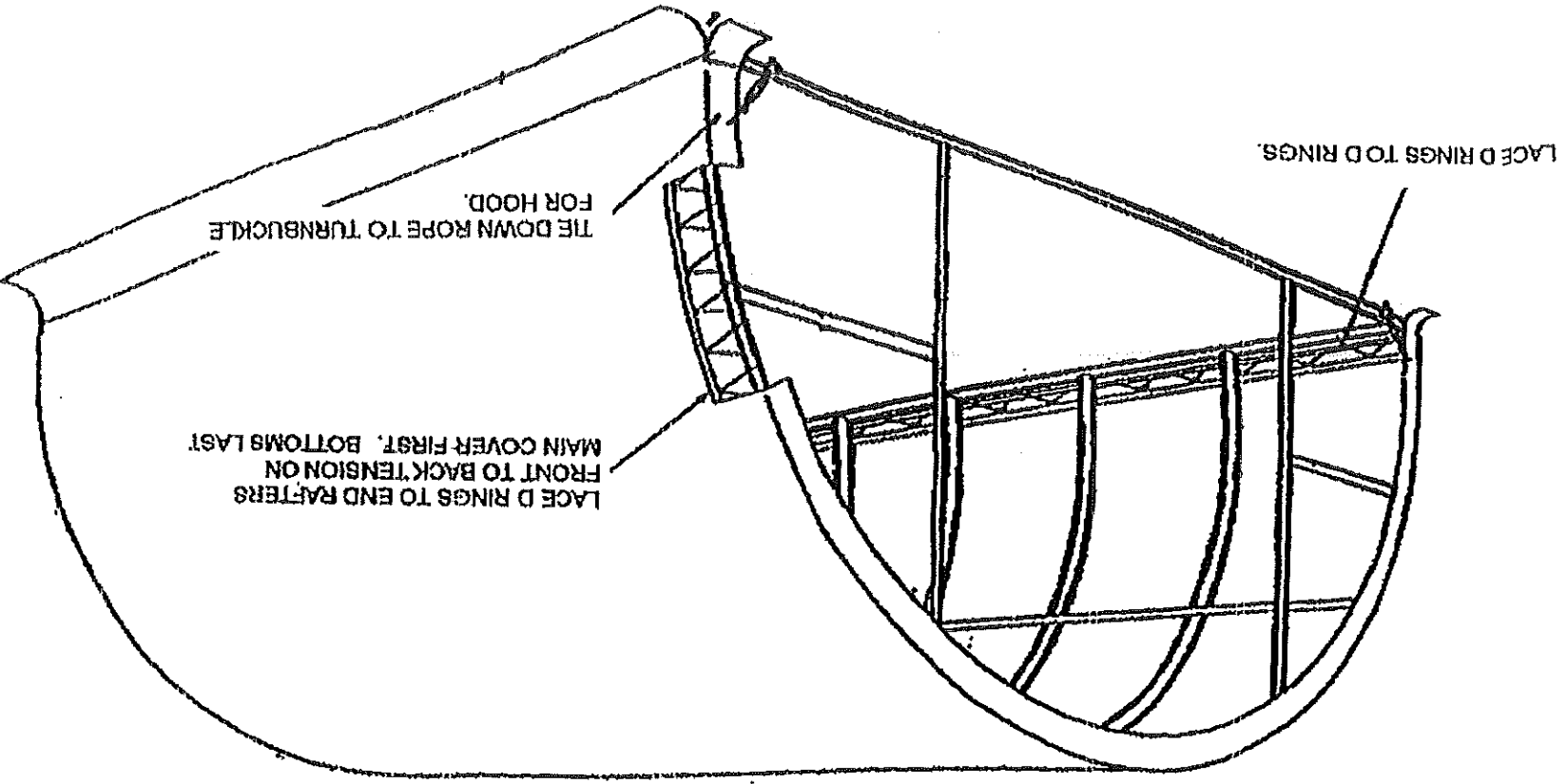

318 A1

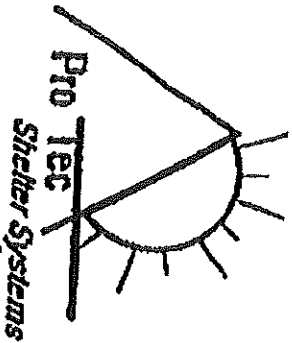

FRONT PANEL

Phone 1-800-699-0844

Fax 1-804-785-8717

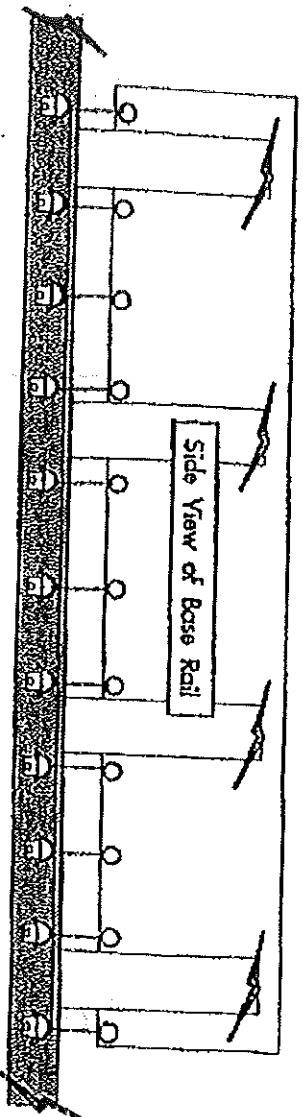
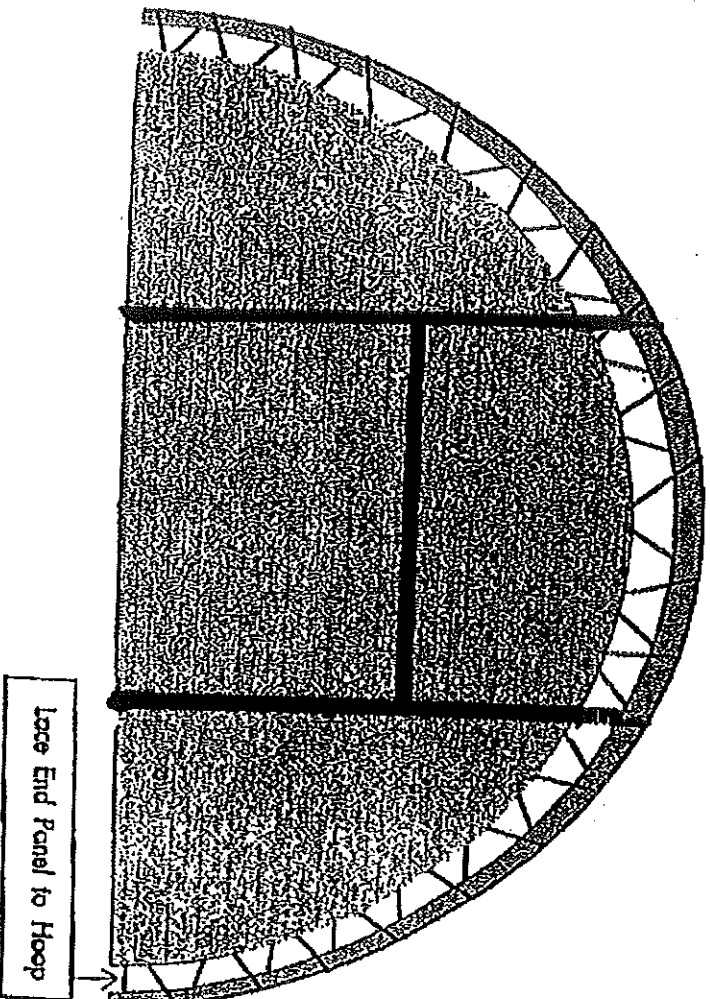

Typical view of D-ring installation and main tarp tie down.

Pro Tec Shelter Systems 616 Dufferin Ave. Sault Ste. Marie, Manitoba, Canada R1A 2J2

315 A1

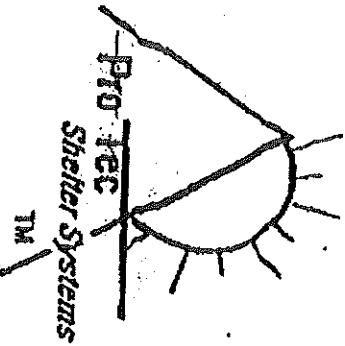

BACK PANEL

Phone 1-800-699-0244

Fax 1-804-785-8717

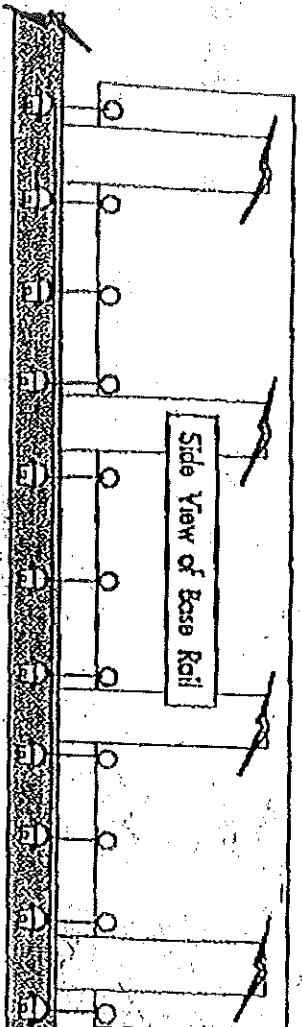
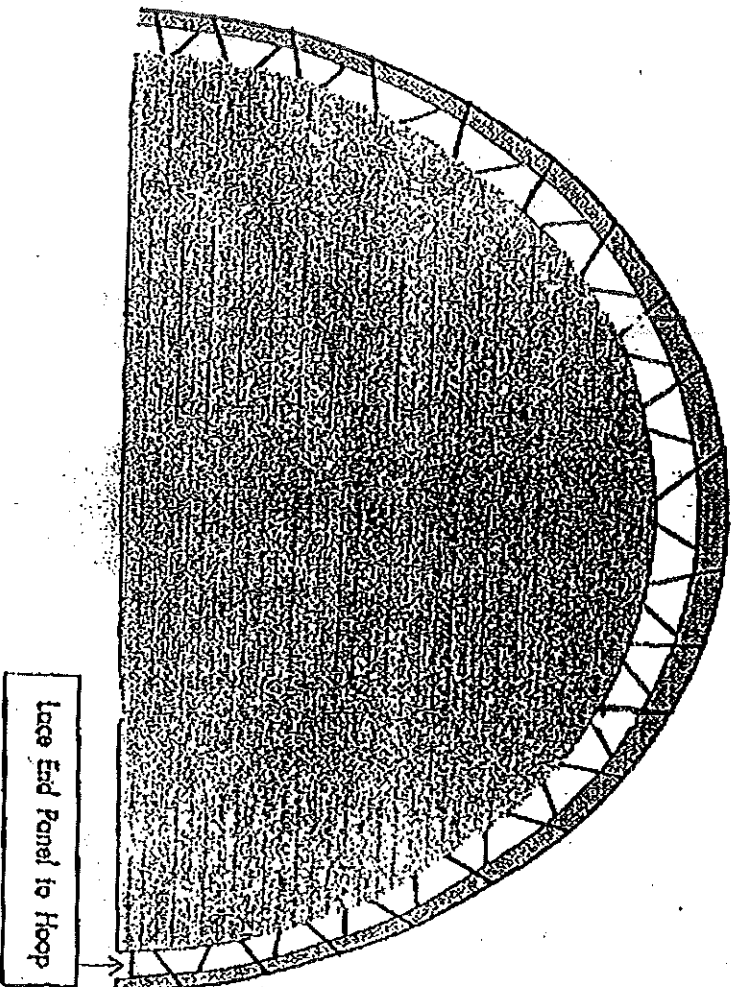

Typical View of D-ring installation and main tarp tie-down.

Pro-Tec Shelter Systems 616 Dufferin Ave Selkirk Manitoba, Canada R1A 2J3

3/18/04