

P.C. SECTION 1
1/2" = 1'-0"

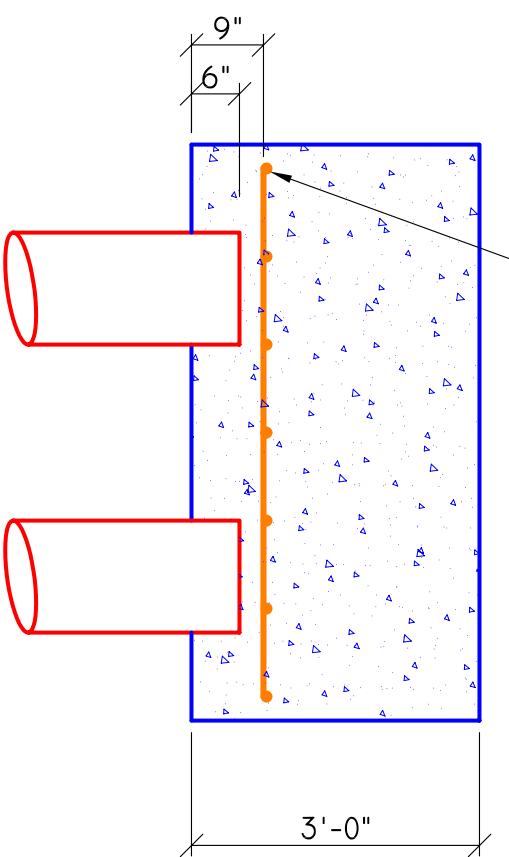

P.C. SECTION 2
1/2" = 1'-0"

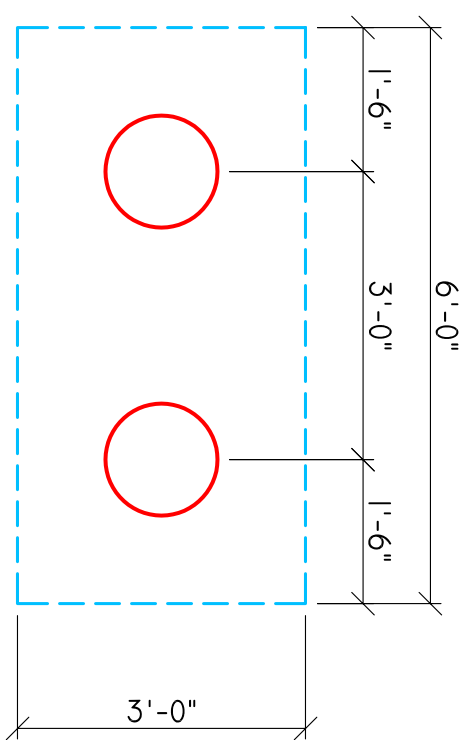
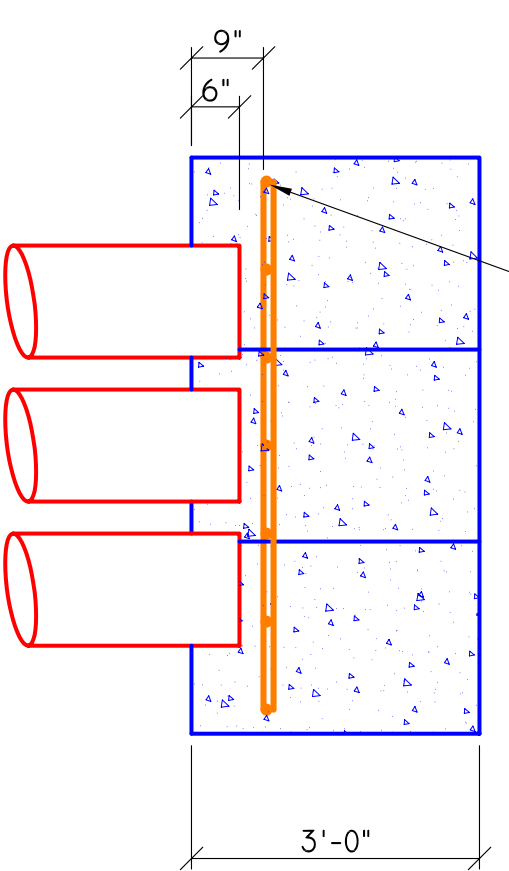
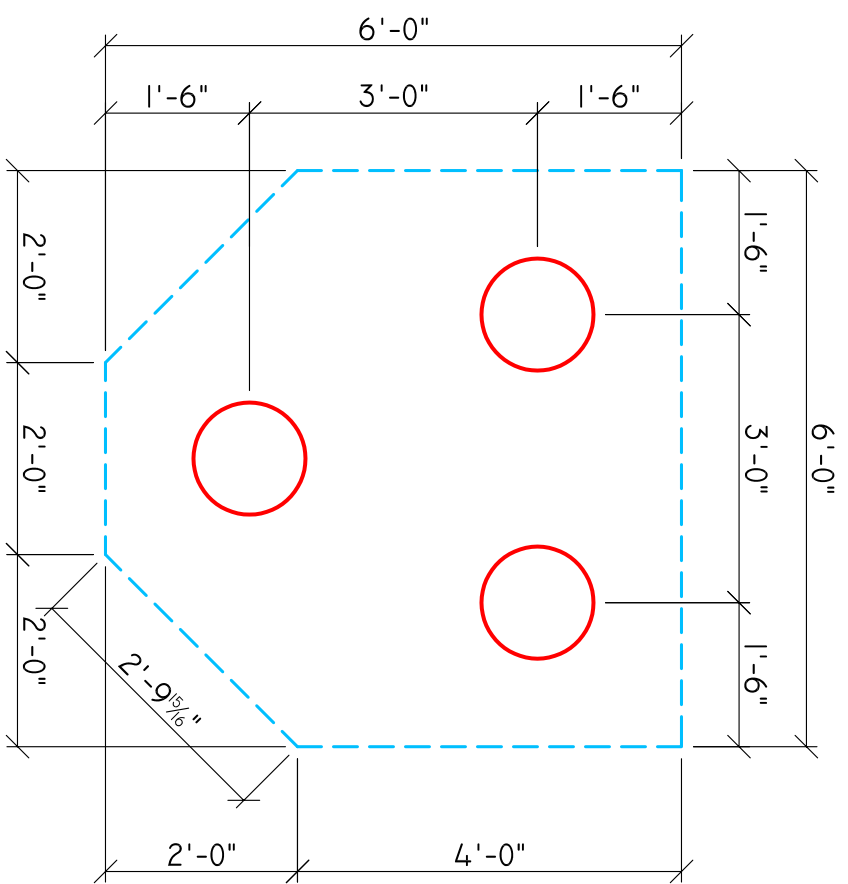

P.C. SECTION 3
1/2" = 1'-0"

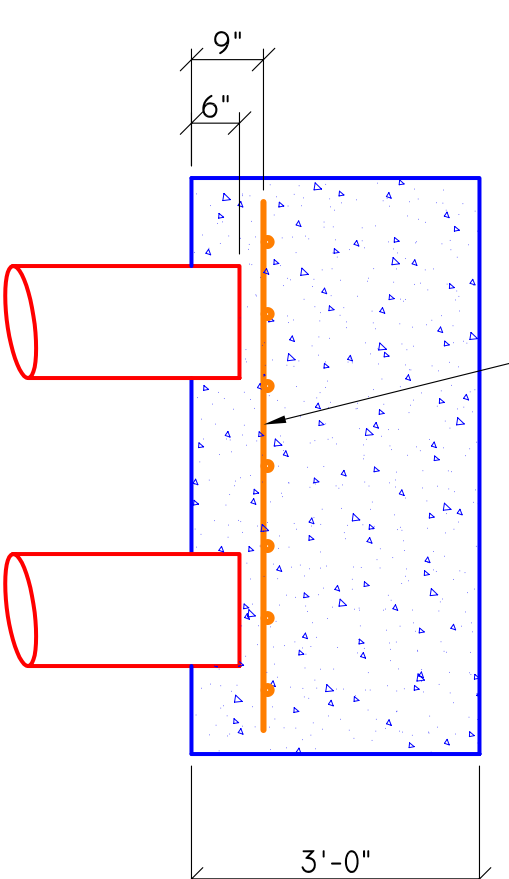
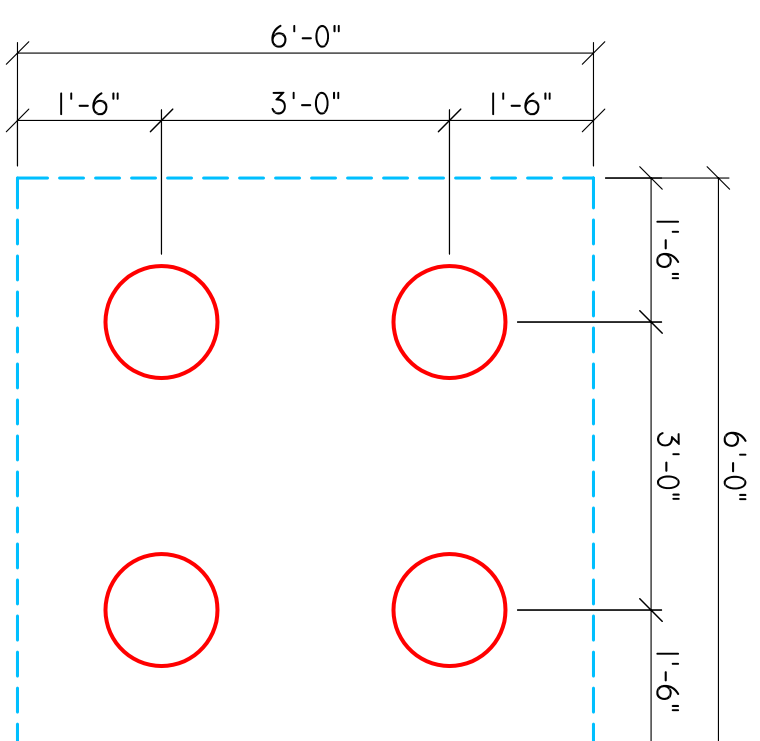

P.C. SECTION 4
1/2" = 1'-0"

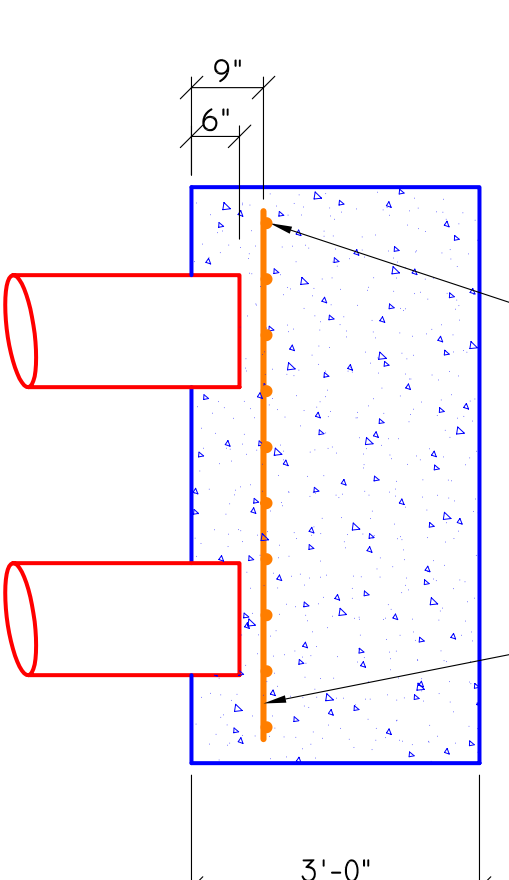
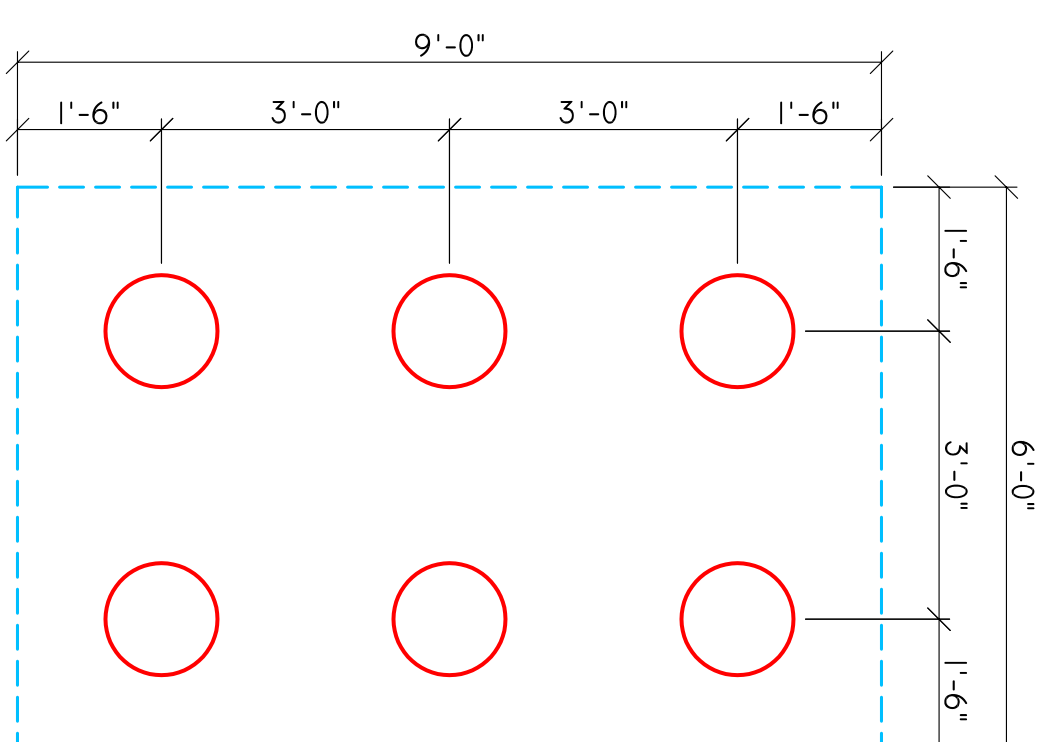

P.C. SECTION 5
1/2" = 1'-0"

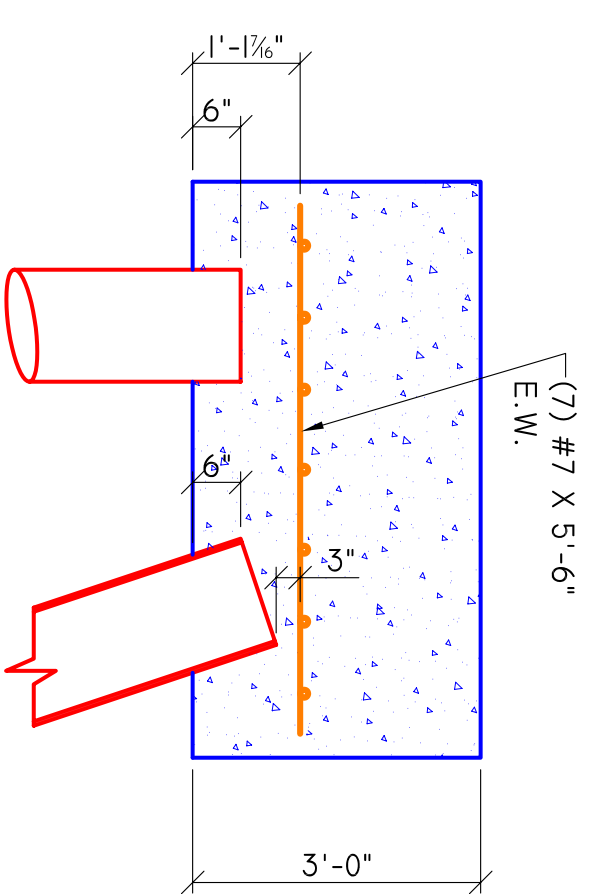
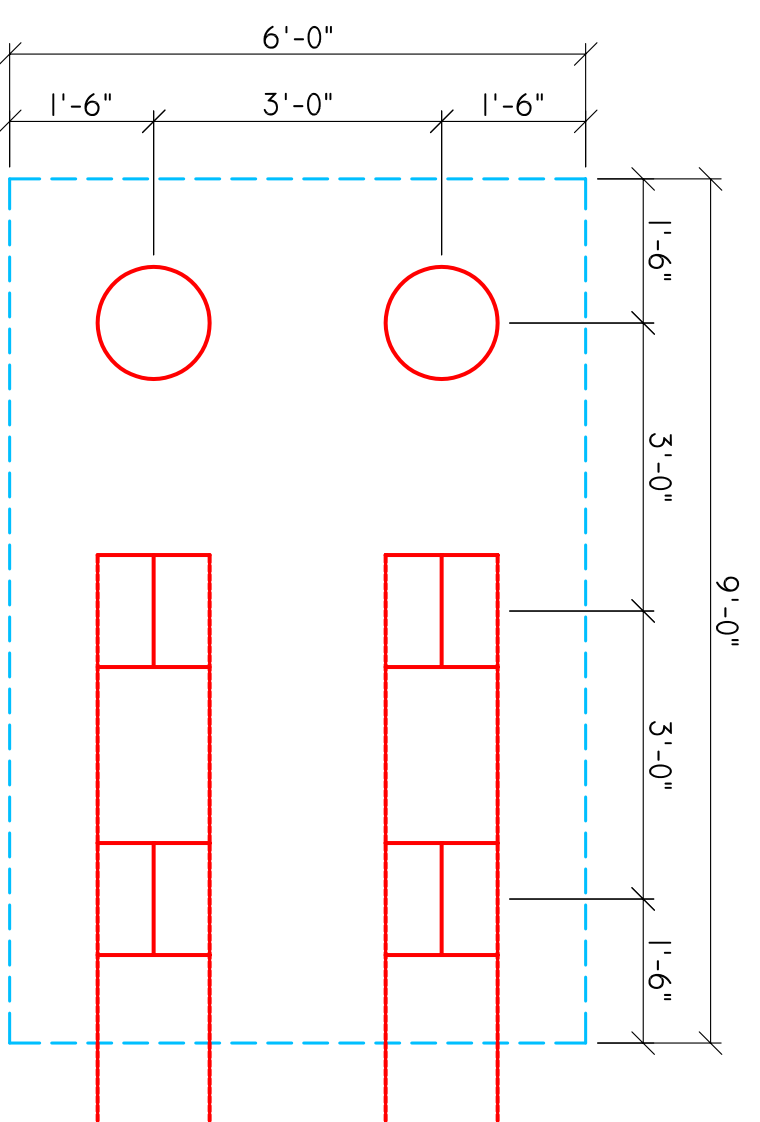
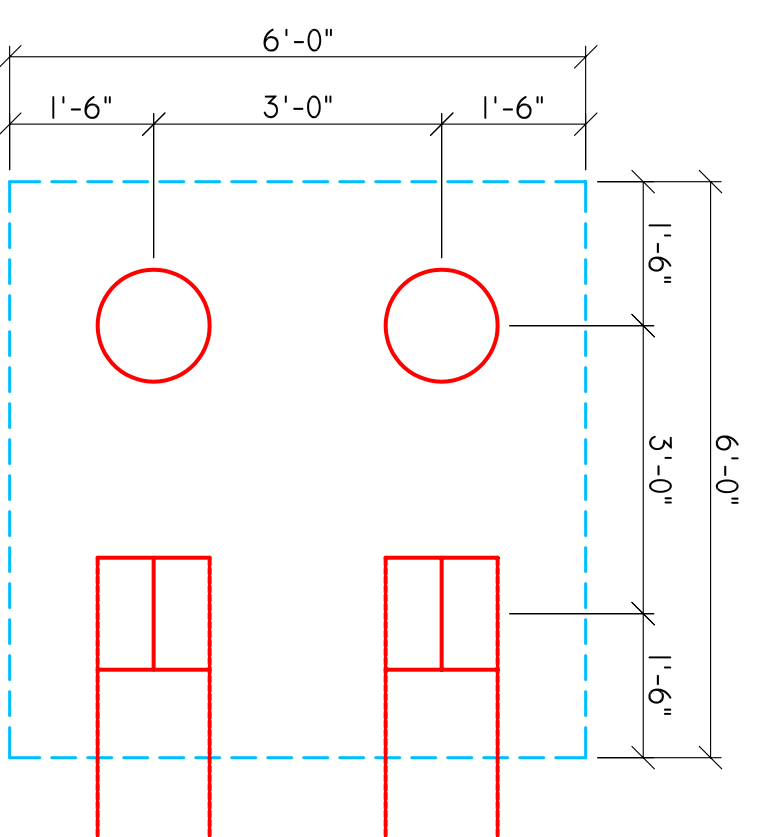

P.C. SECTION 6
1/2" = 1'-0"

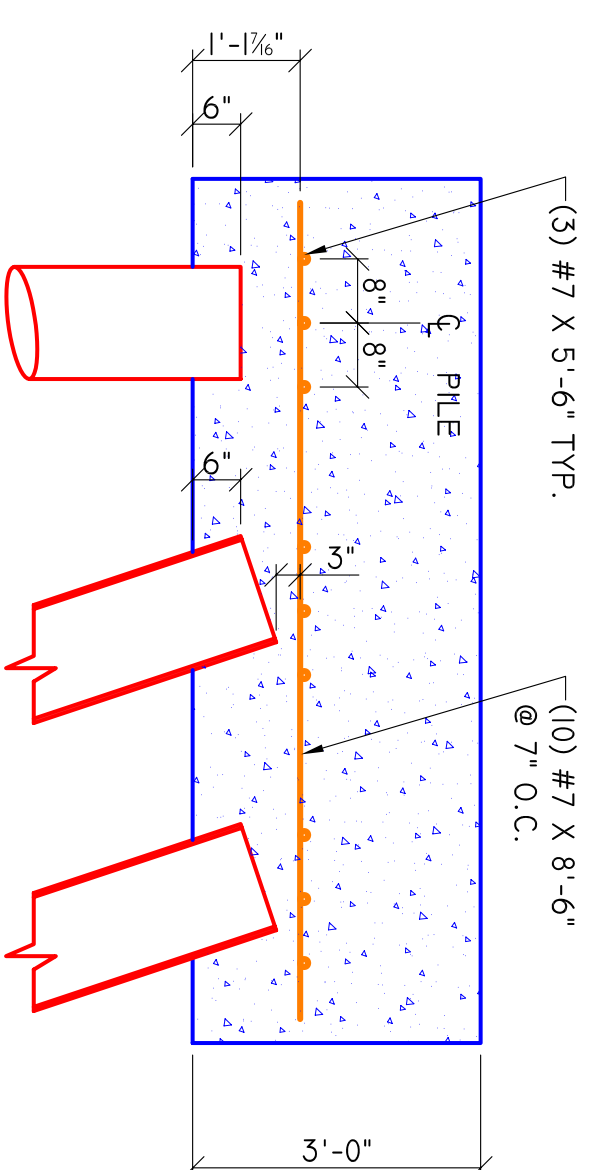

P.C. SECTION 7
1/2" = 1'-0"

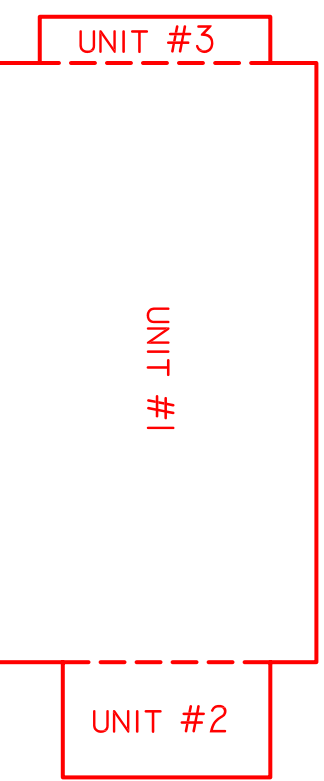

REVISION

DATE	REVISION	EST. NO.	SIZE
06/03/04	ISSUED FOR FOUNDATION PERMIT	83406	

ENGINEERING DESIGNERS FOR
MAINE YACHT CENTER
 100 KENSINGTON STREET
 PORTLAND, MAINE

FOUNDATION
 PILE CAP SECTIONS

DESIGN BUILDER

JOB NO. 030017
 ENGINEERING DWG. NO. F5

Sheridan
 FAIRFIELD
 MAINE
 www.sheridandesign.com