

DOOR SCHEDULE				
NO.	LOCATION	SIZE	TYPE	DOOR MAT. / FRAM MAT.
100	PUMP HOUSE	(2) 2830	A	HC / WF

TYPICAL DOOR TYPE:



WINDOW SCHEDULE

NO.	LOCATION	SIZE	TYPE	NOTES
1	PUMP HOUSE	(2) 2830	SGJ HUNG	OPAQUE GLASS

- NOTES:
1. WINDOWS TO HAVE OPAQUE GLASS.
 2. WINDOWS TO BE NON-LOCKABLE FROM THE OUTSIDE TO PROVIDE ACCESS TO LIGHT STRIPS.

MULLED TOGETHER

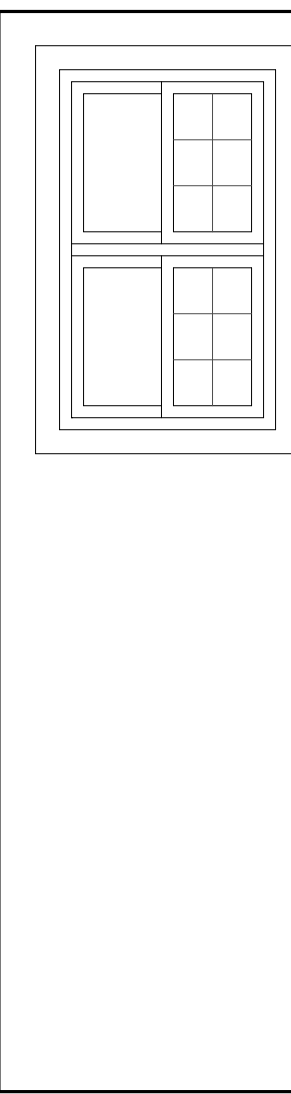

NOTE:
 UNPAK ENTIRE EXTERIOR OF BUILDING WITH BLDG PAPER AND EXTERIOR FINISHES
 BEHINDING BY STRIPPING AWAY FINISHES TO REVEAL THE SUBSTRATE. MAINTAIN
 ALL ORIGINAL MATERIALS AND FINISHES TO BE REPAIRED OR REPLACED AS NECESSARY.
 ALL REPAIRS TO BE APPROVED BY ARCHITECT. PROVIDE TO THE CONTRACTOR.

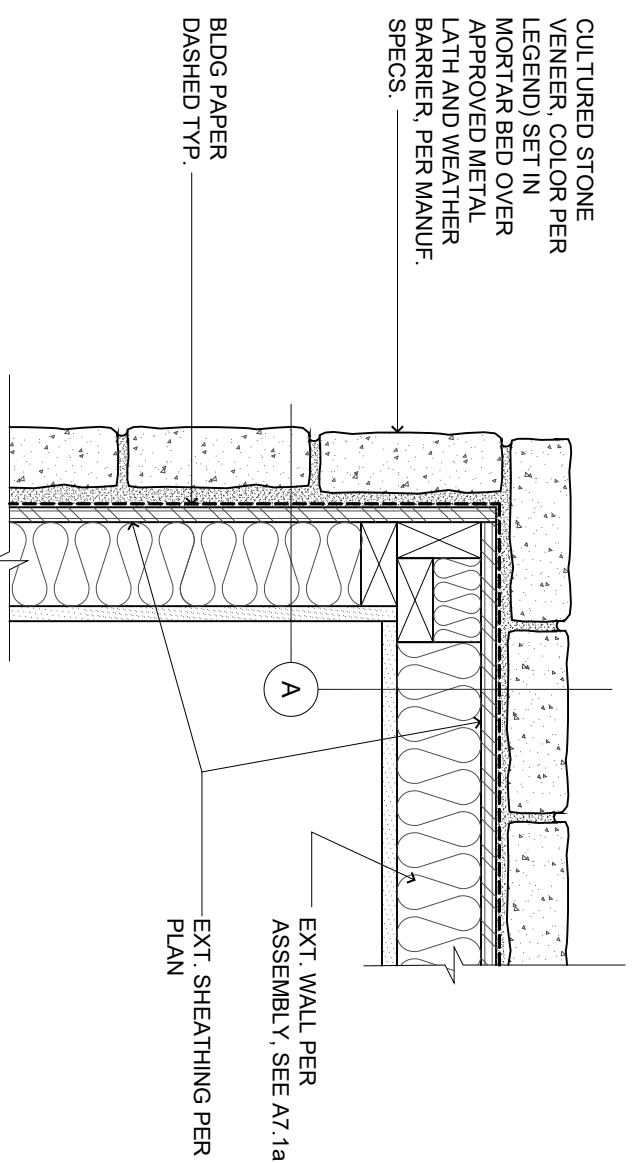

STONE CORNER (STONE AT TYPICAL OUTSIDE CORNER)

SCALE: 1-1/2" = 1'-0"

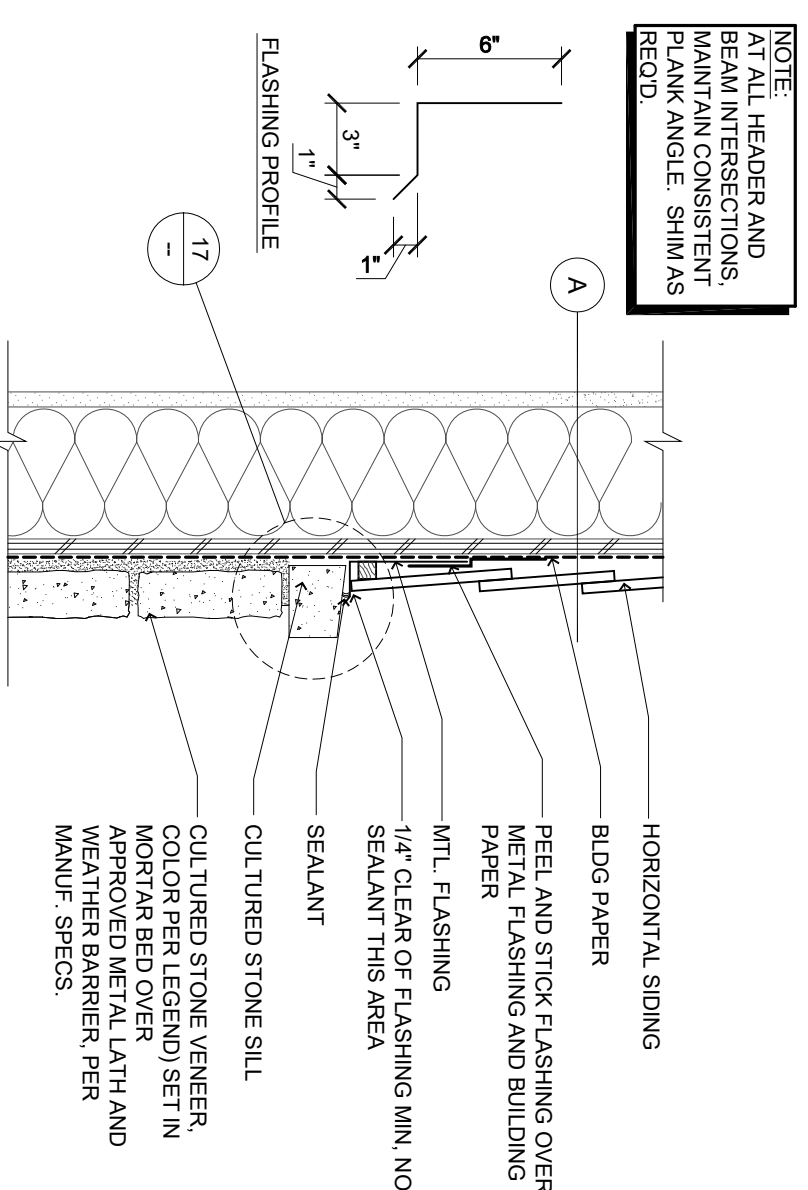

EXTERIOR WALL DETAIL (STONE / CEM. BRD. SIDING)

SCALE: 1-1/2" = 1'-0"

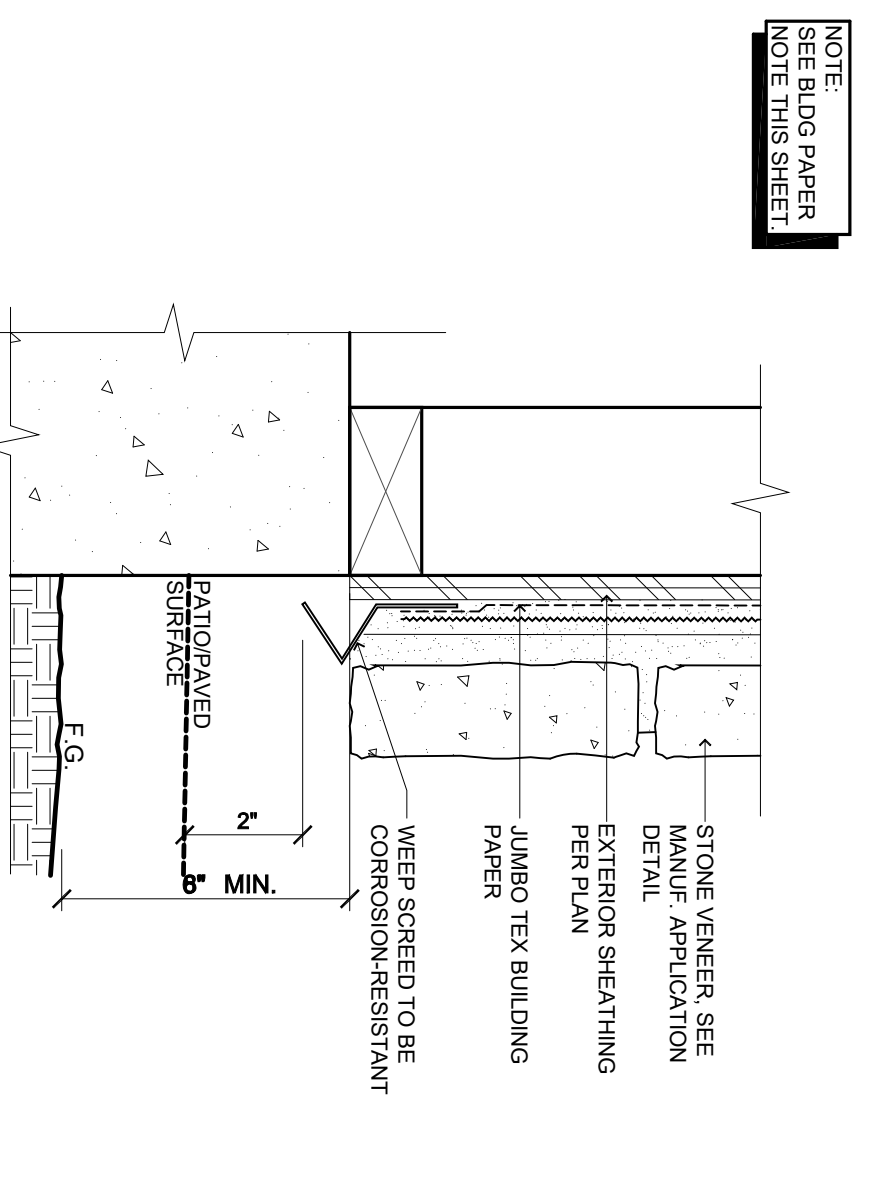

EXTERIOR WALL DETAIL (WEEP SCREEN)

SCALE: 3" = 1'-0"

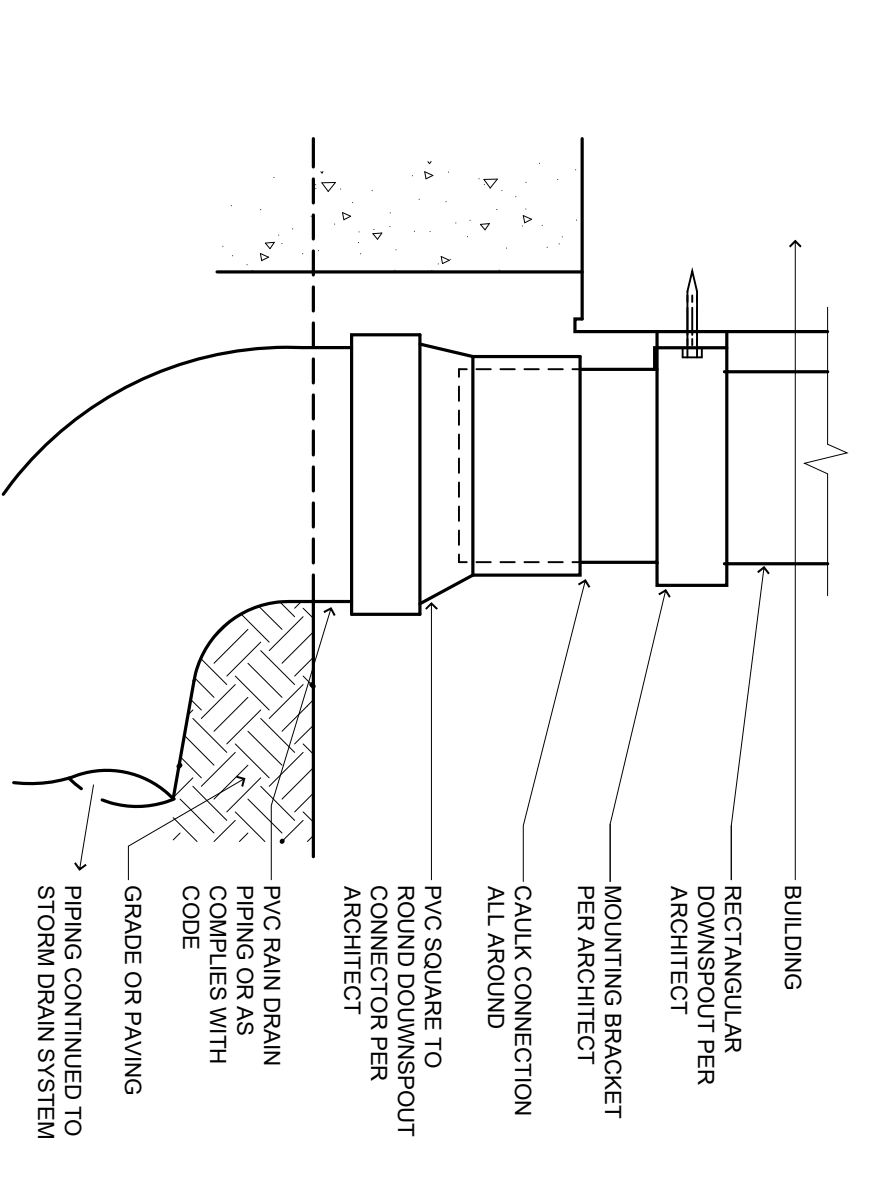

INSTALLATION DETAIL (DOWNPOUT CONNECTION)

SCALE: N.T.S.

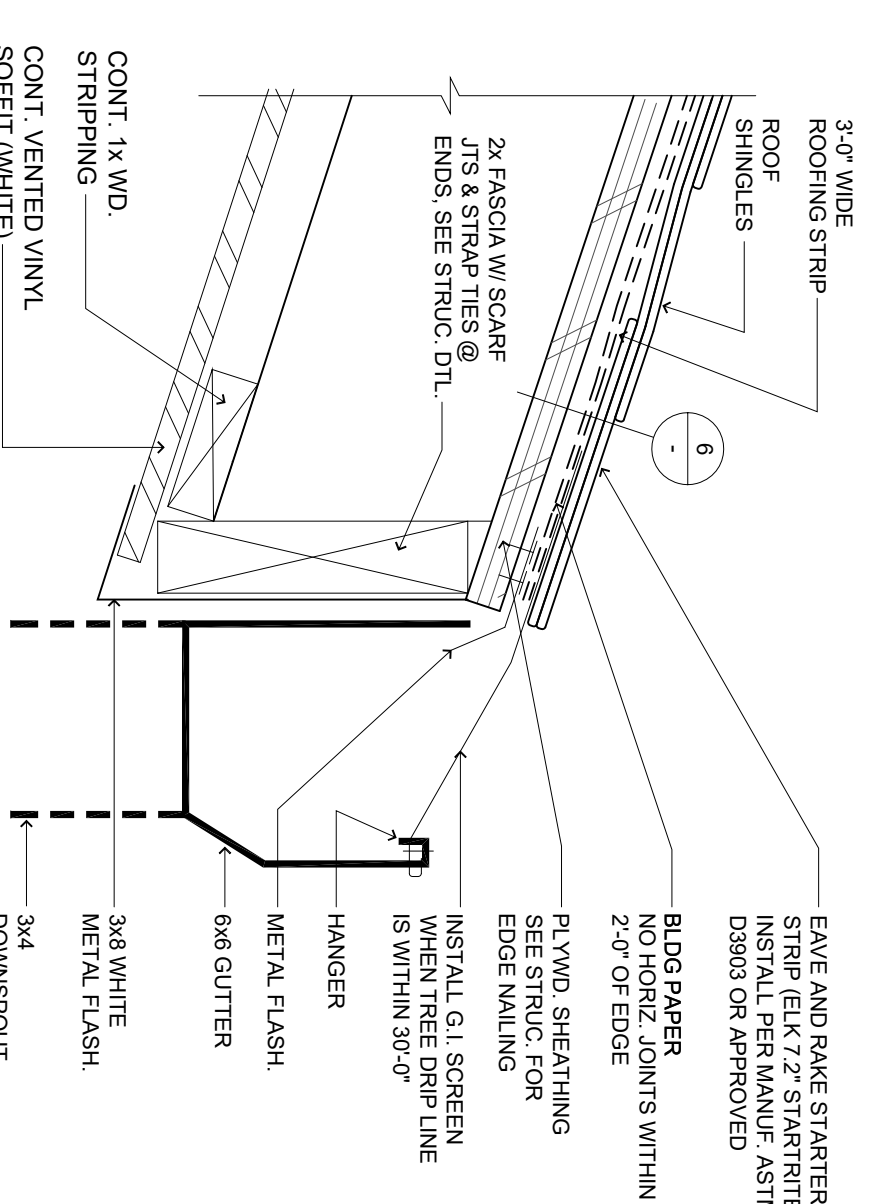

FOR VENTILATION:
 2" DIA. HOLE = 3.14 SQ. IN.
 (2) HOLES PER LF. = 6.28 SQ. IN. PER LF.

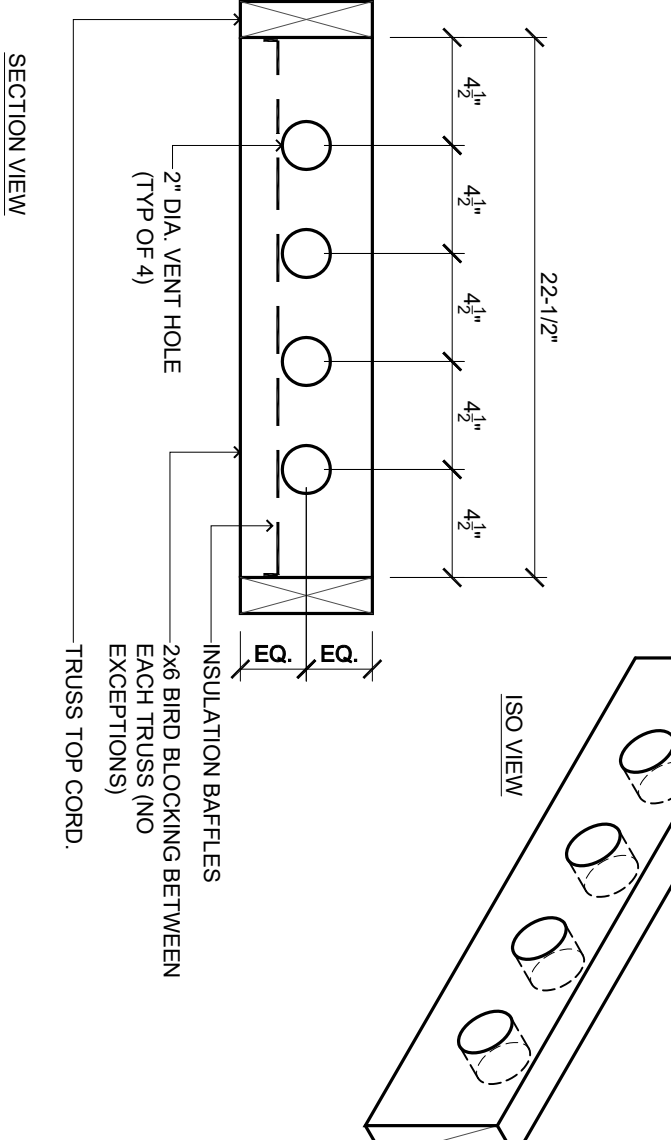

EXTERIOR EAVE BLOCKING (TRUSSES BEARING ON WALL TOP PLATE)

SCALE: 1-1/2" = 1'-0"

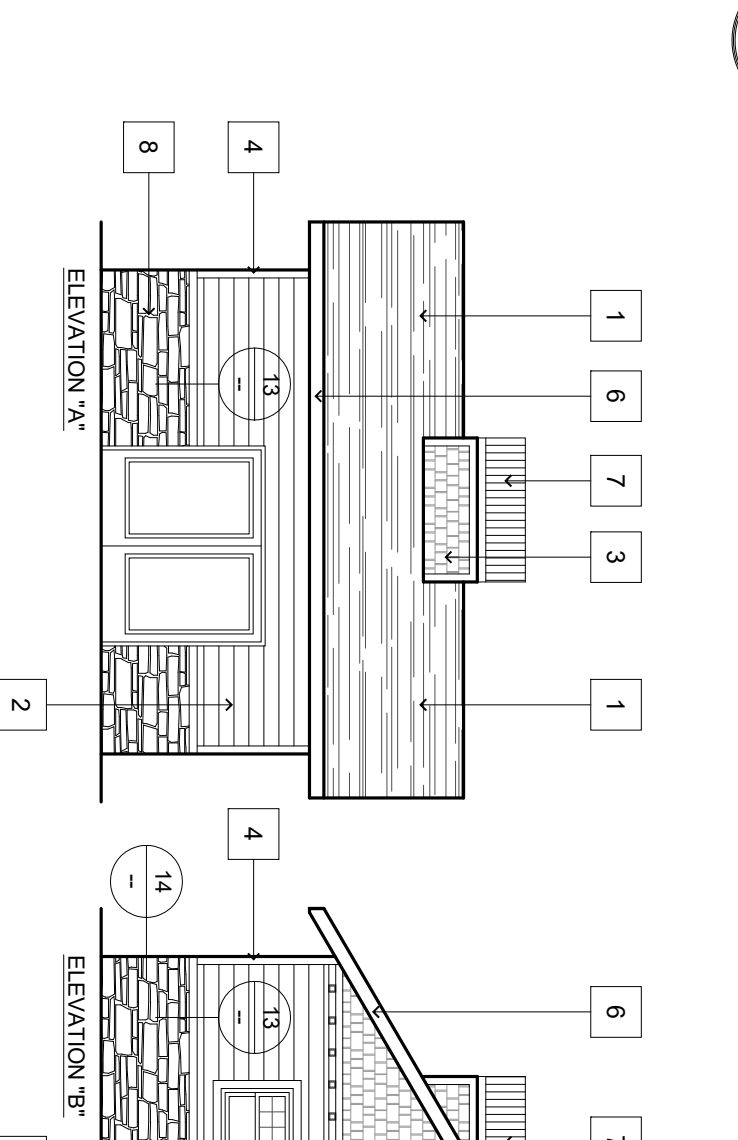

PUMP HOUSE (ELEVATIONS)

SCALE: 1/8" = 1'-0"

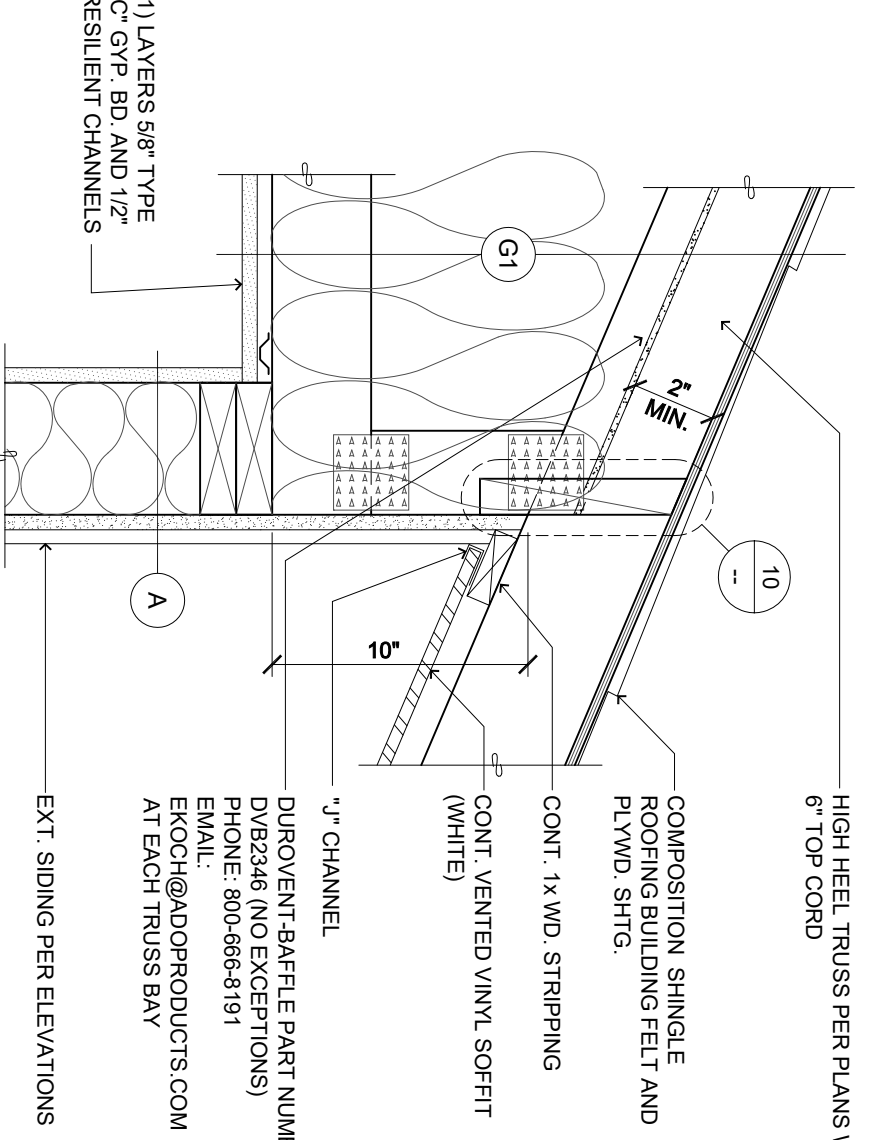

EXTERIOR WALL-ROOF INTERSECTION (HIGH HEEL TRUSS)

SCALE: N.T.S.

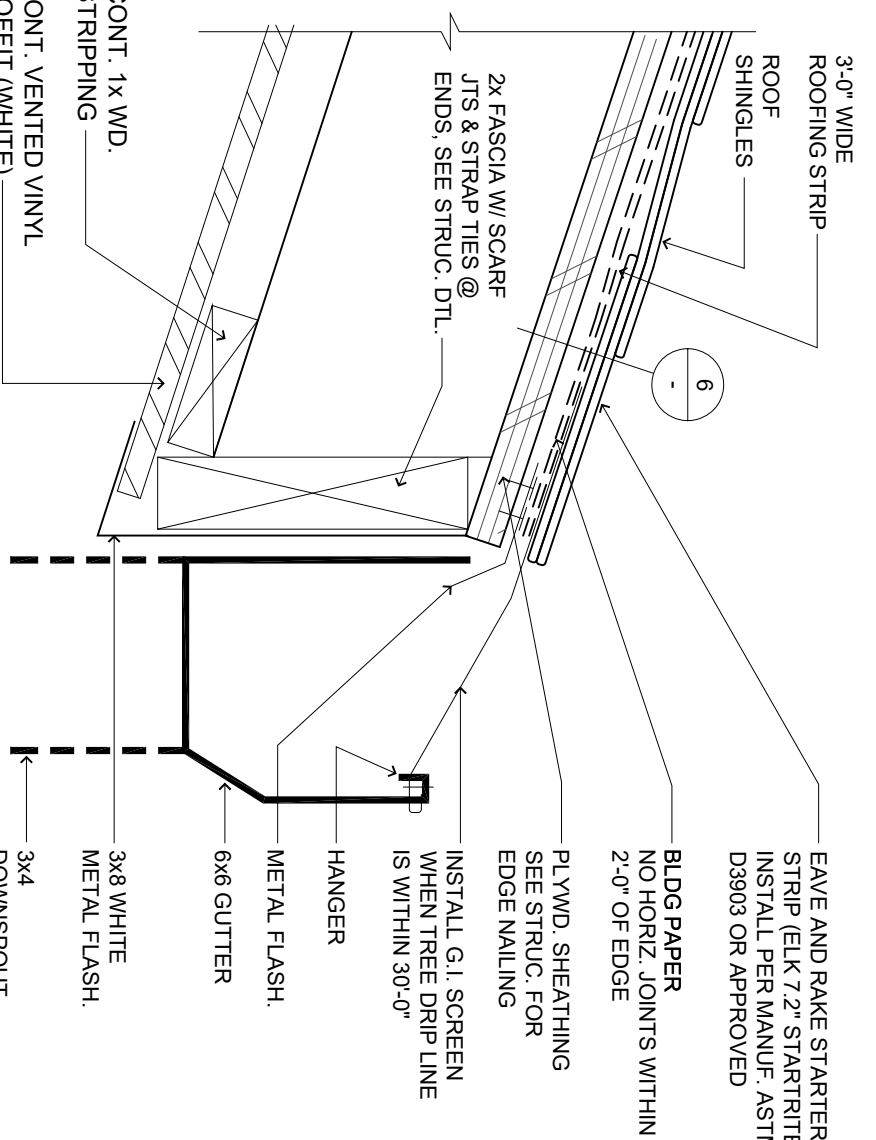

EAVE GUTTER ASSEMBLY (ROOF WITH COMPOSITION SHINGLES)

SCALE: 3" = 1'-0"

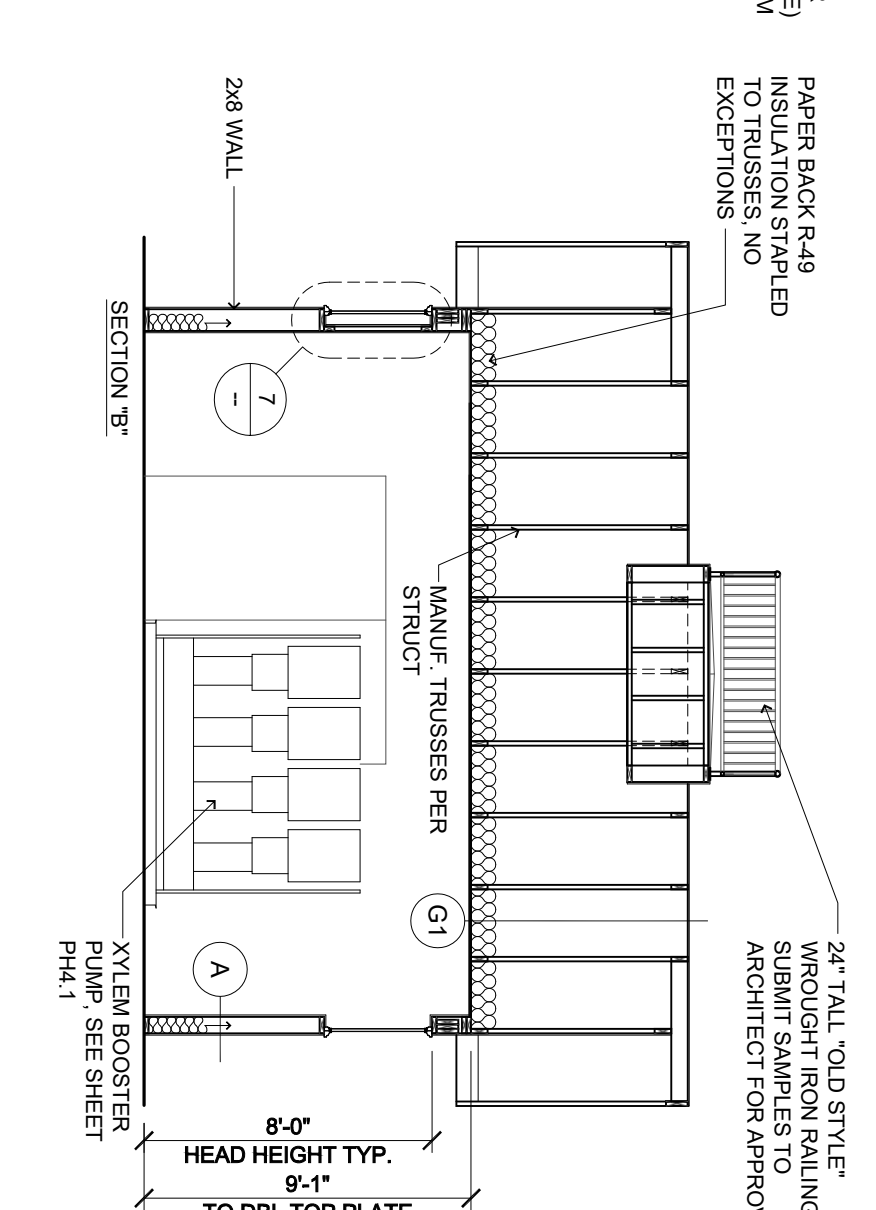

PUMP HOUSE (WINDOW DETAIL)

SCALE: 1" = 1'-0"

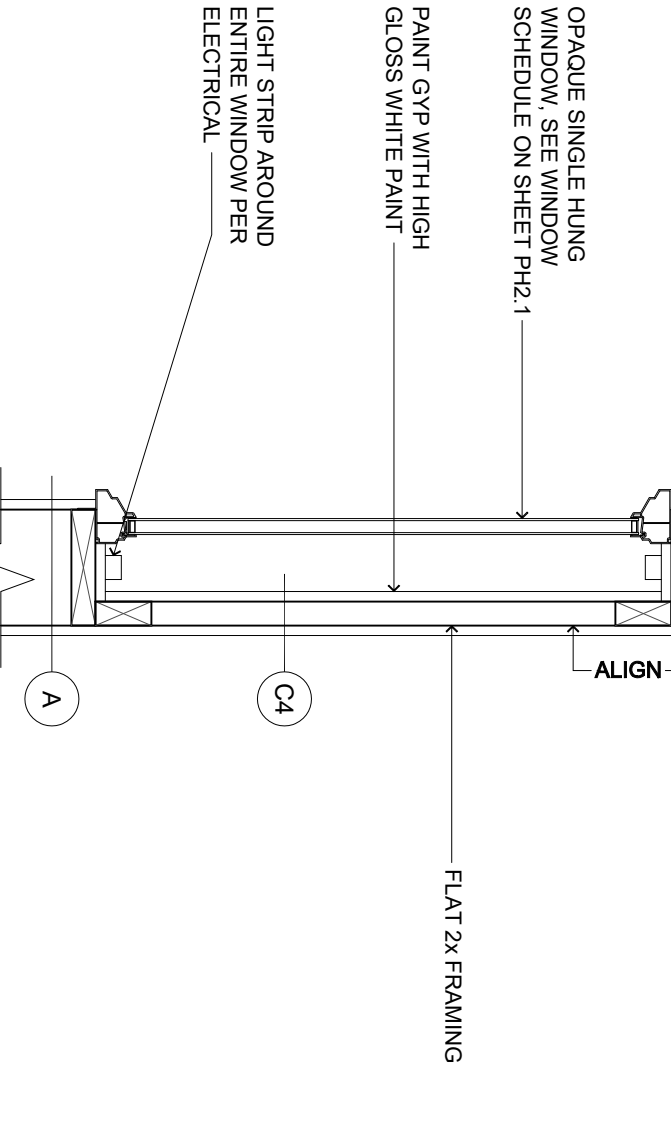

PUMP HOUSE (SECTION A)

SCALE: 3/16" = 1'-0"

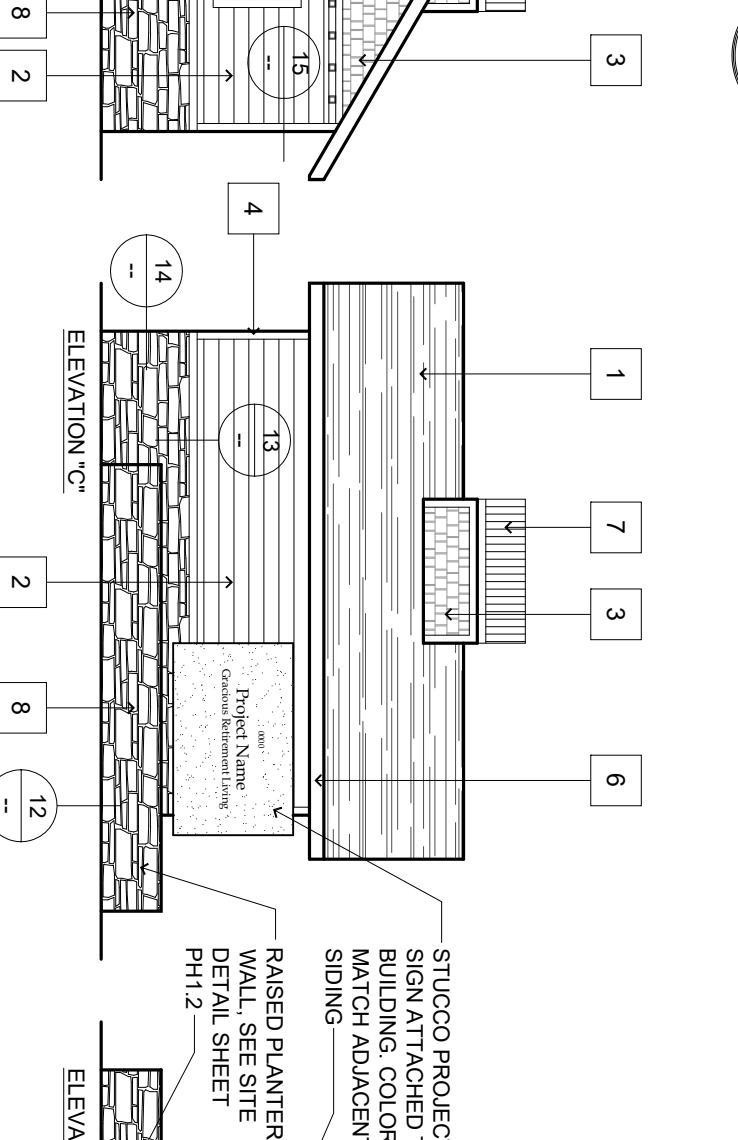

PUMP HOUSE (SECTION B)

SCALE: 3/16" = 1'-0"

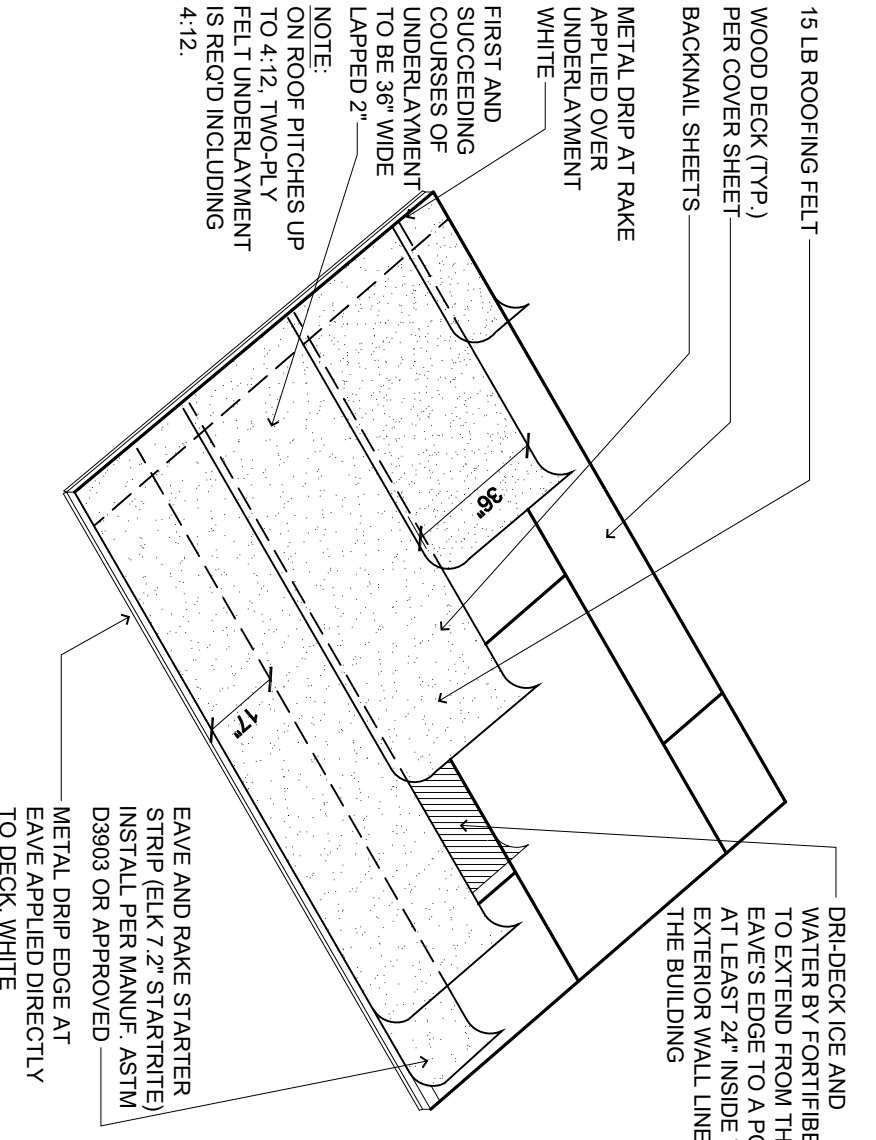

ROOF UNDERLAYMENT (ASSEMBLY DETAIL)

SCALE: N.T.S.

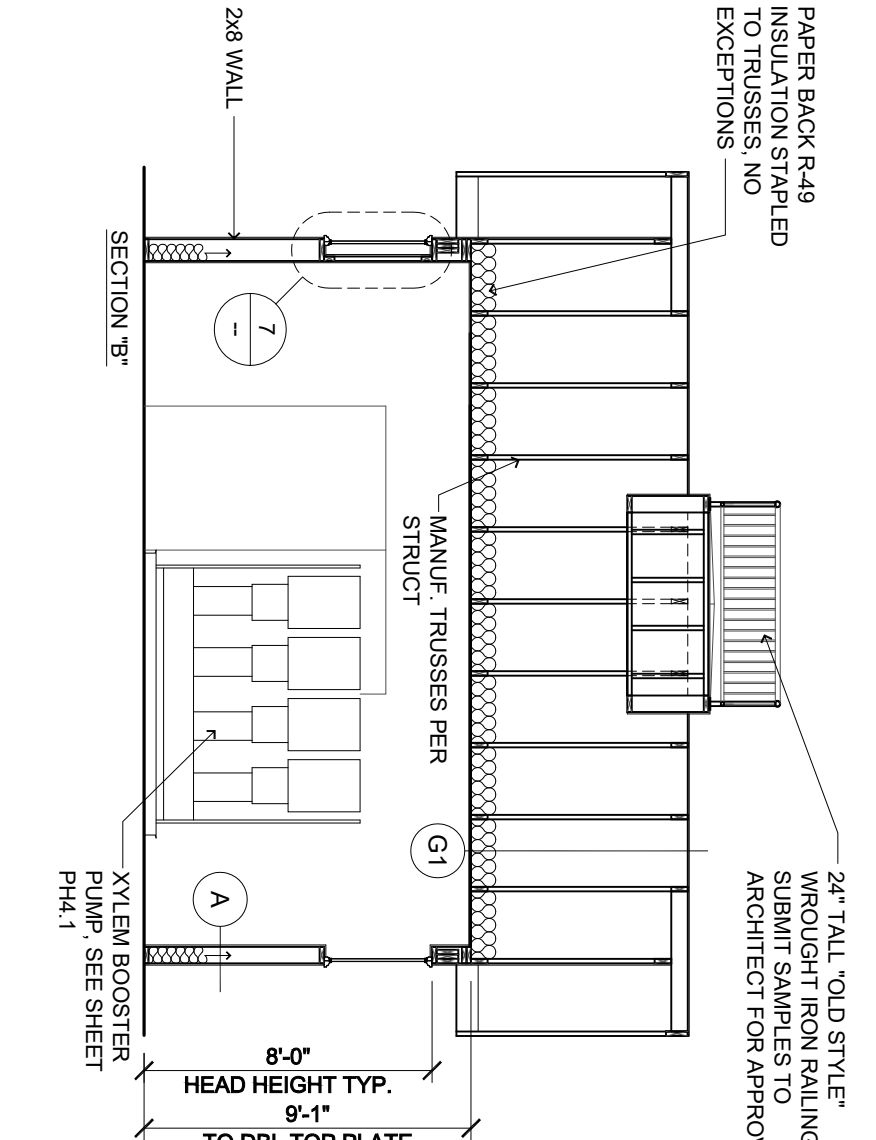

PUMP HOUSE (SECTION B)

SCALE: 3/16" = 1'-0"

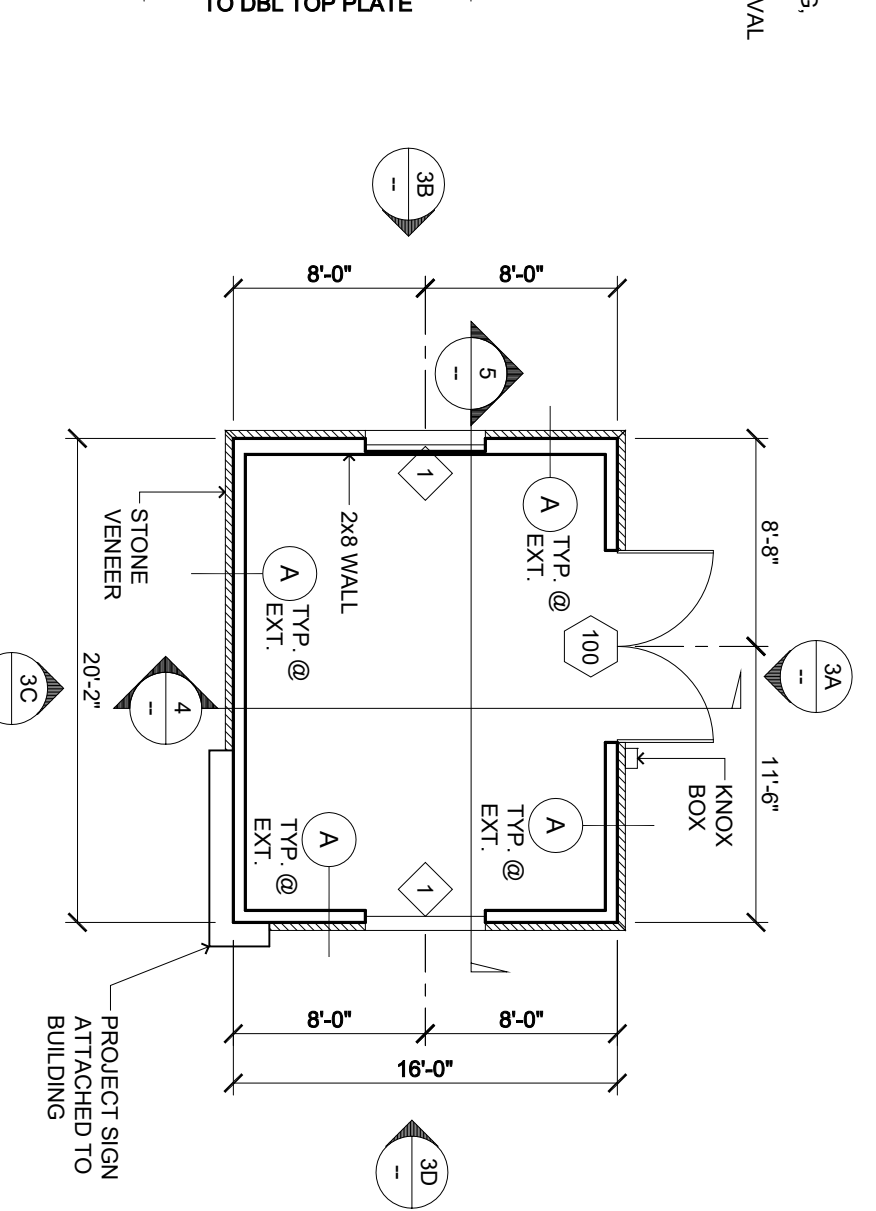

PUMP HOUSE (FLOOR PLAN)

SCALE: 1/8" = 1'-0"

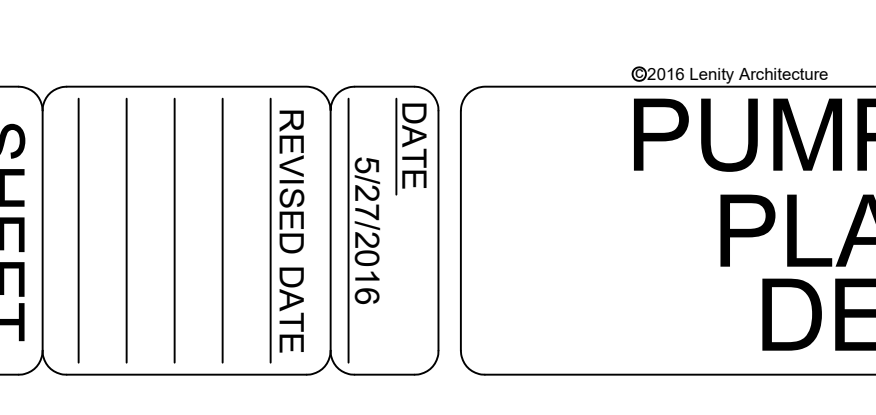

KEY NOTES/COLORS	
1	= ARCH. COMP. 25 YR.
2	= CEILING BOARD SIDING - POB OUTS
3	= SHINGLES SIDING (LEAVES)
4	= TRIM BOARD
5	= VINYL FRAMED INSULATED WINDOW
6	= 2x8 FASCIA W/CONT. GUTTER
7	= 2x4" TALL "OLD STYLE" WROUGHT-IRON RAILING. SUBMIT SAMPLES TO ARCHITECT FOR APPROVAL.
8	= CORONADO STONE PRODUCTS STONE. COLOR: TRENK.