

11 HVAC ABOVE DOUBLE TOP PLATE
(TRANSFER FROM SHAFT TO CORRIDOR)
SCALE: 1" = 1'-0"

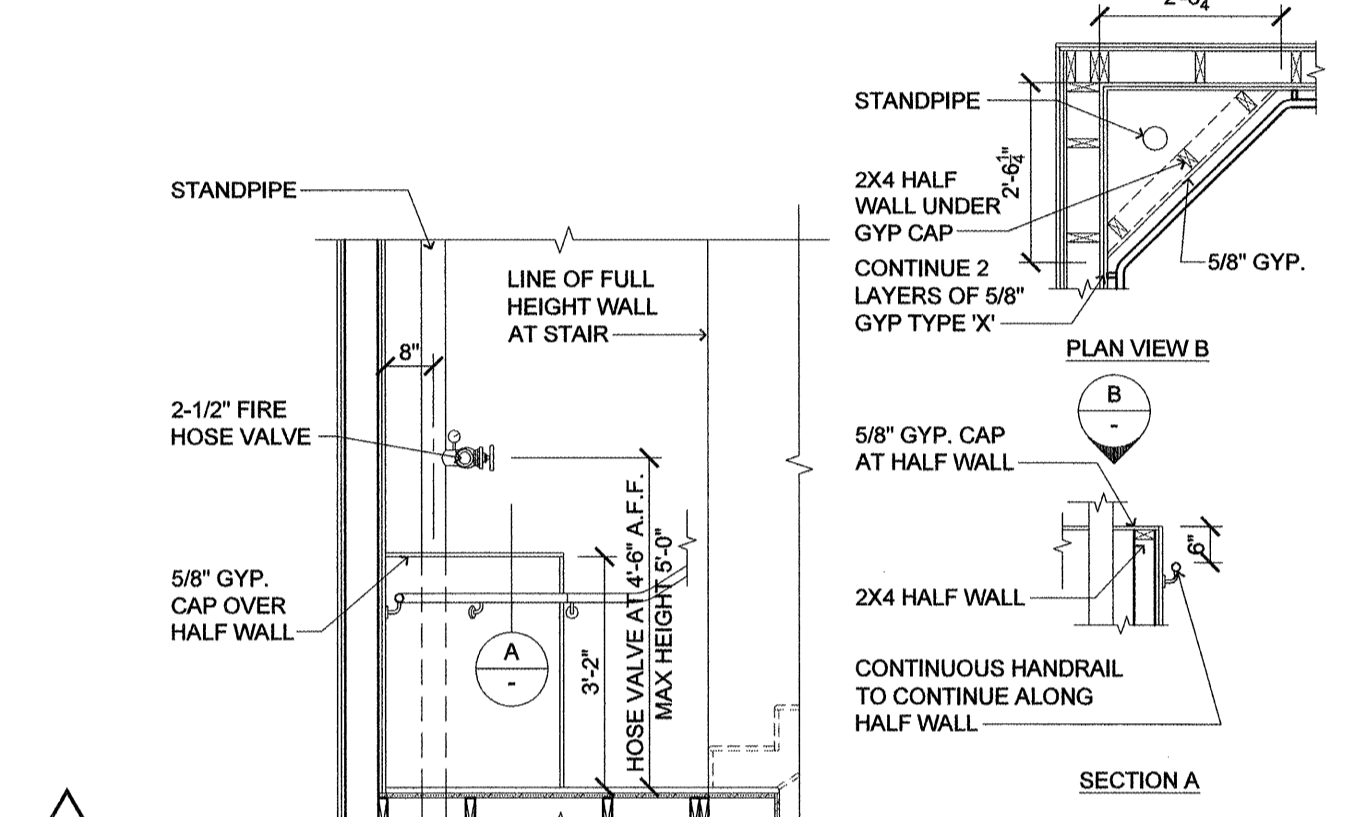

10 STANDPIPE HALF WALL
(AT 2 HOUR STAIRS)
SCALE: 3/8" = 1'-0"

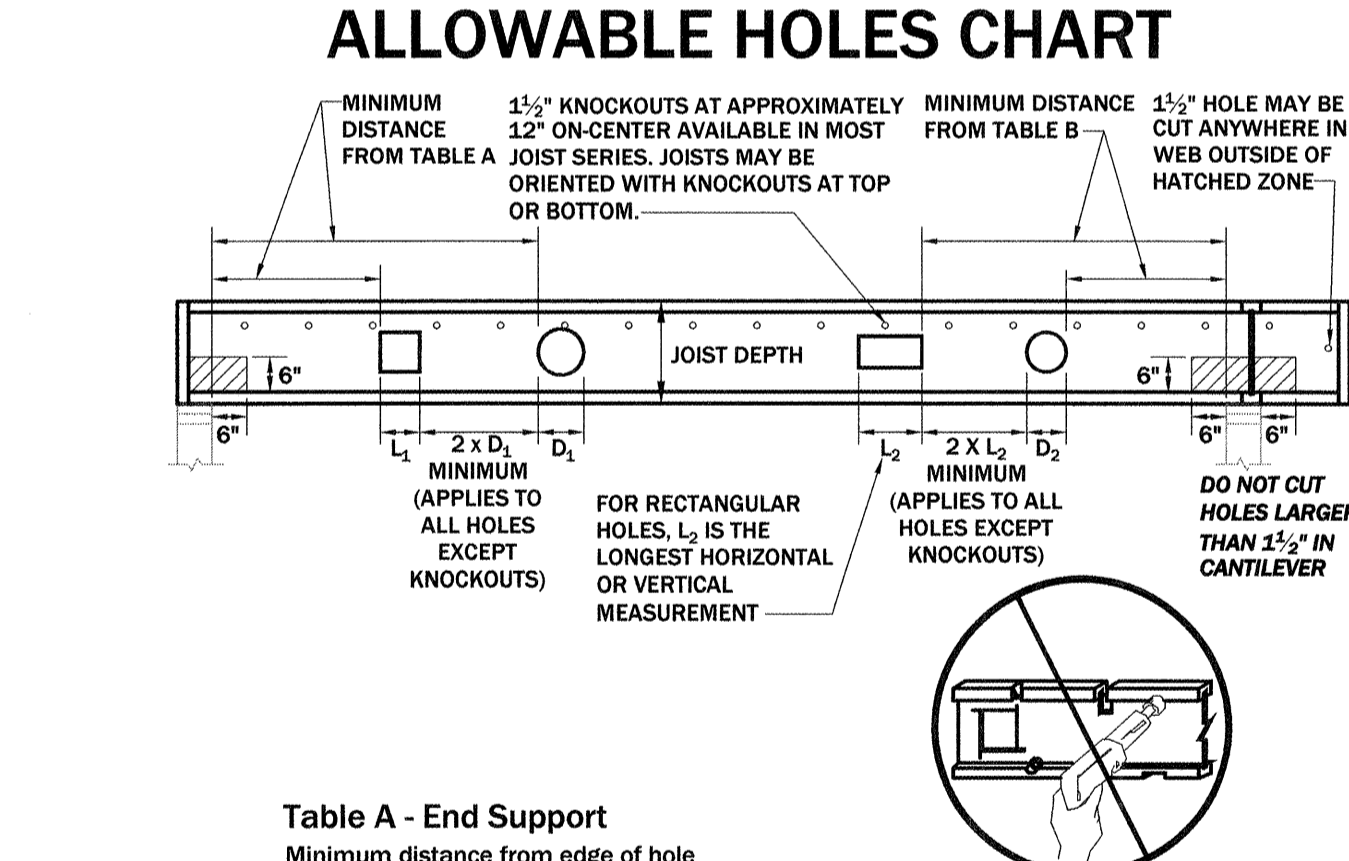

Table A - End Support
Minimum distance from edge of hole to inside face of nearest end support

Joist Depth	Joist Series	Round Hole Size									
		2"	4"	6"	8"	10"	12"	14"	16"	18"	20"
		Square or Rectangular Hole Size									
9 1/2"	145 / 165	1'-6"	3'-0"	5'-0"	-	-	-	-	-	-	-
18"	190 / 190H	1'-0"	1'-0"	2'-6"	5'-0"	7'-0"	9'-6"	12'-6"	-	-	-

Table B - Intermediate or Cantilever Support
Minimum distance from edge of hole to inside face of nearest intermediate or cantilever support

Joist Depth	Joist Series	Round Hole Size									
		2"	4"	6"	8"	10"	12"	14"	16"	18"	20"
		Square or Rectangular Hole Size									
9 1/2"	145 / 165	1'-6"	4'-0"	6'-6"	-	-	-	-	-	-	-
18"	190 / 190H	1'-0"	1'-0"	2'-6"	5'-6"	9'-0"	12'-6"	17'-0"	-	-	-

9 INSTALLATION DETAIL
(I-JOIST ALLOWABLE HOLE CHART)
SCALE: NOT TO SCALE

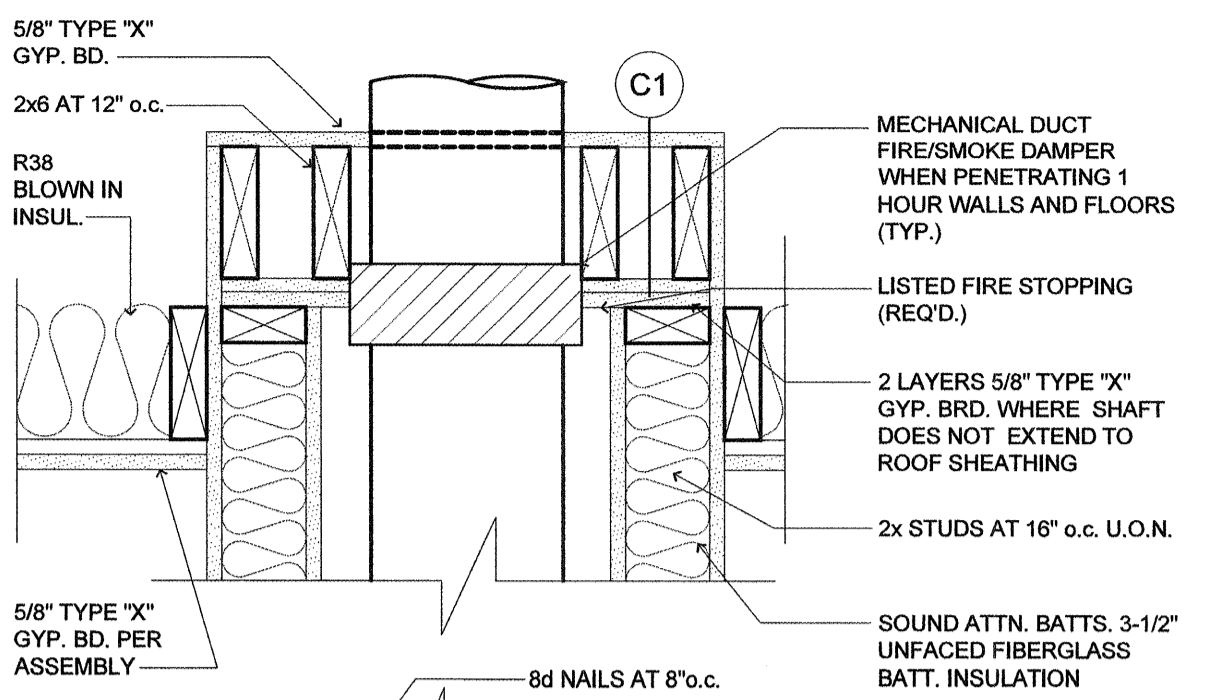

7 FIXTURE PROTECTION
HEAT LAMP, LIGHT FIXTURE/SPEAKER
SCALE: N.T.S.

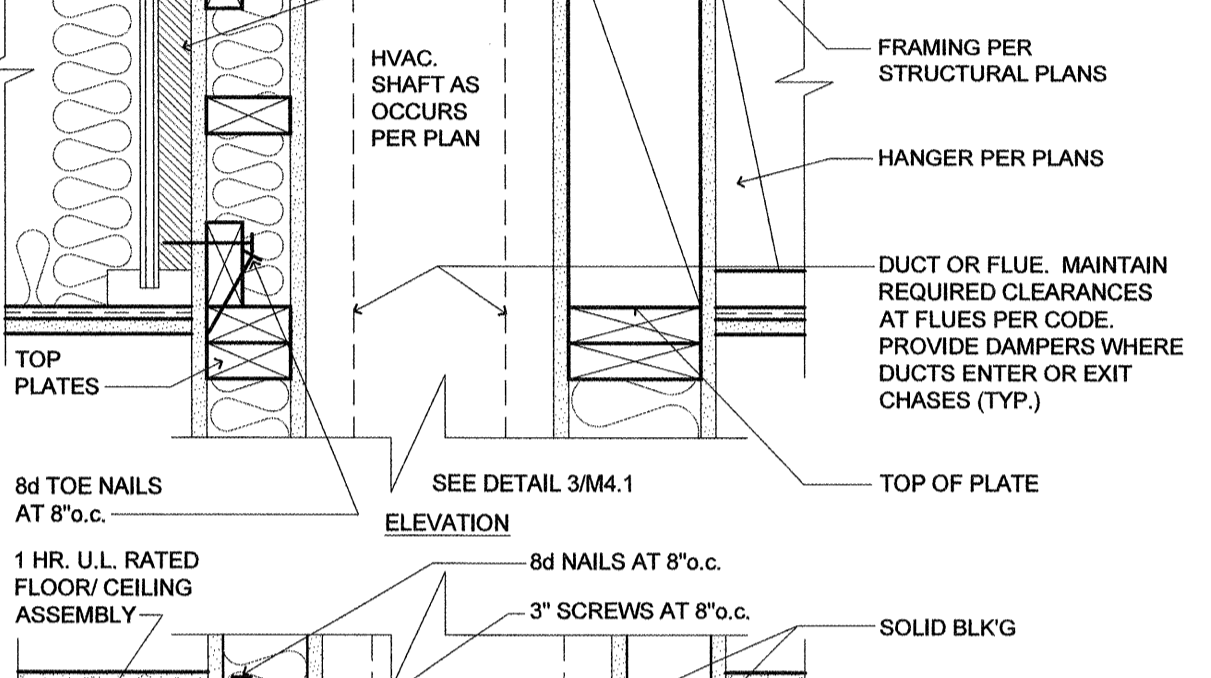

4 FIRE/SMOKE DAMPER IN WALL
SCALE: N.T.S.

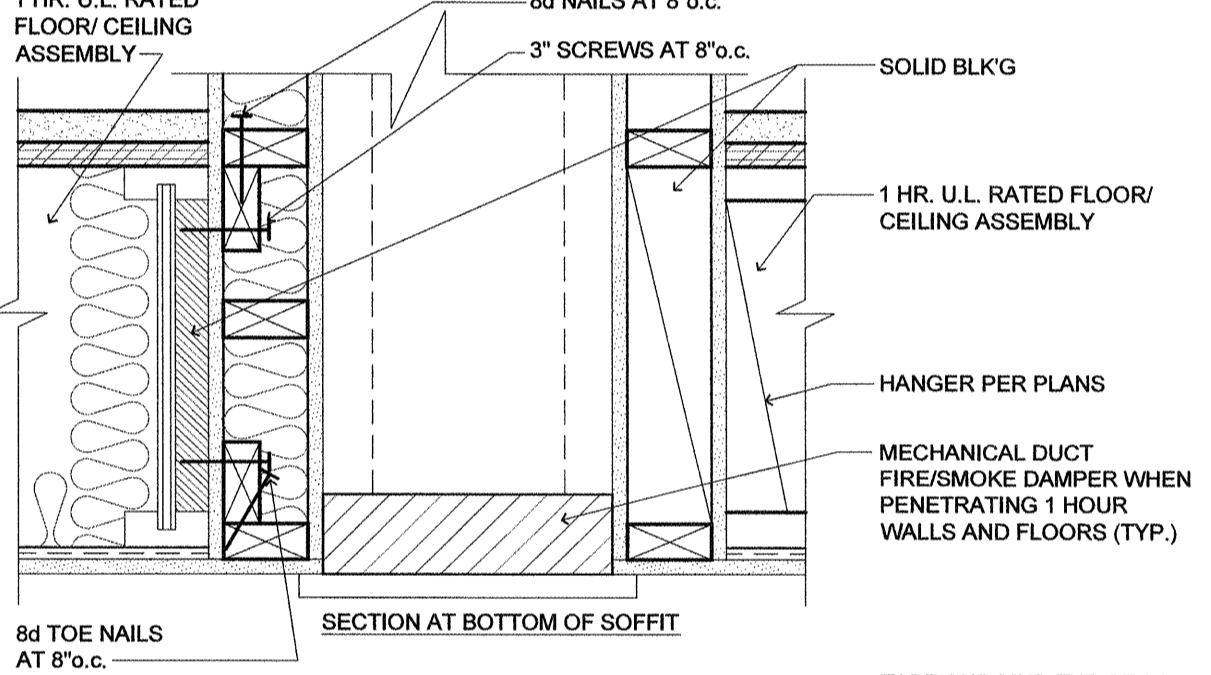

3 SECTION AT CORRIDOR
(ALL TRADES TO COORDINATE AVAILABLE SPACE)
SCALE: 1-1/2" = 1'-0"

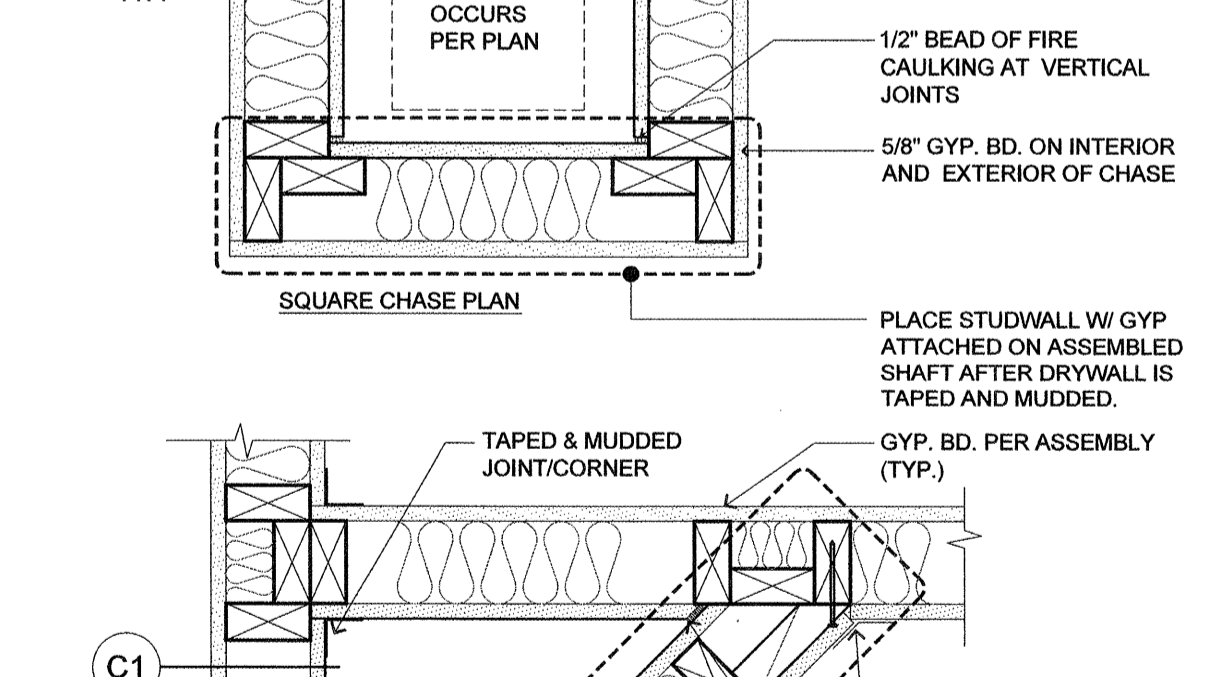

2 TUB AND SHOWER DRAIN DETAIL
SCALE: N.T.S.

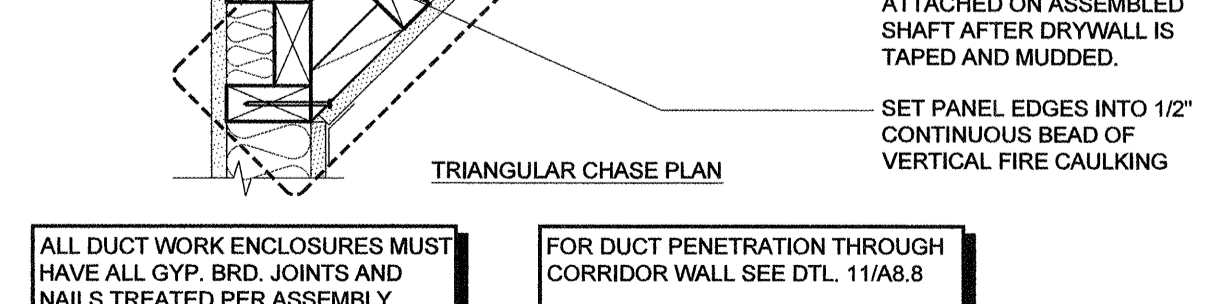

1 PLUMBING DETAIL
(AT FIRE RATED CONSTRUCTION)
SCALE: N.T.S.

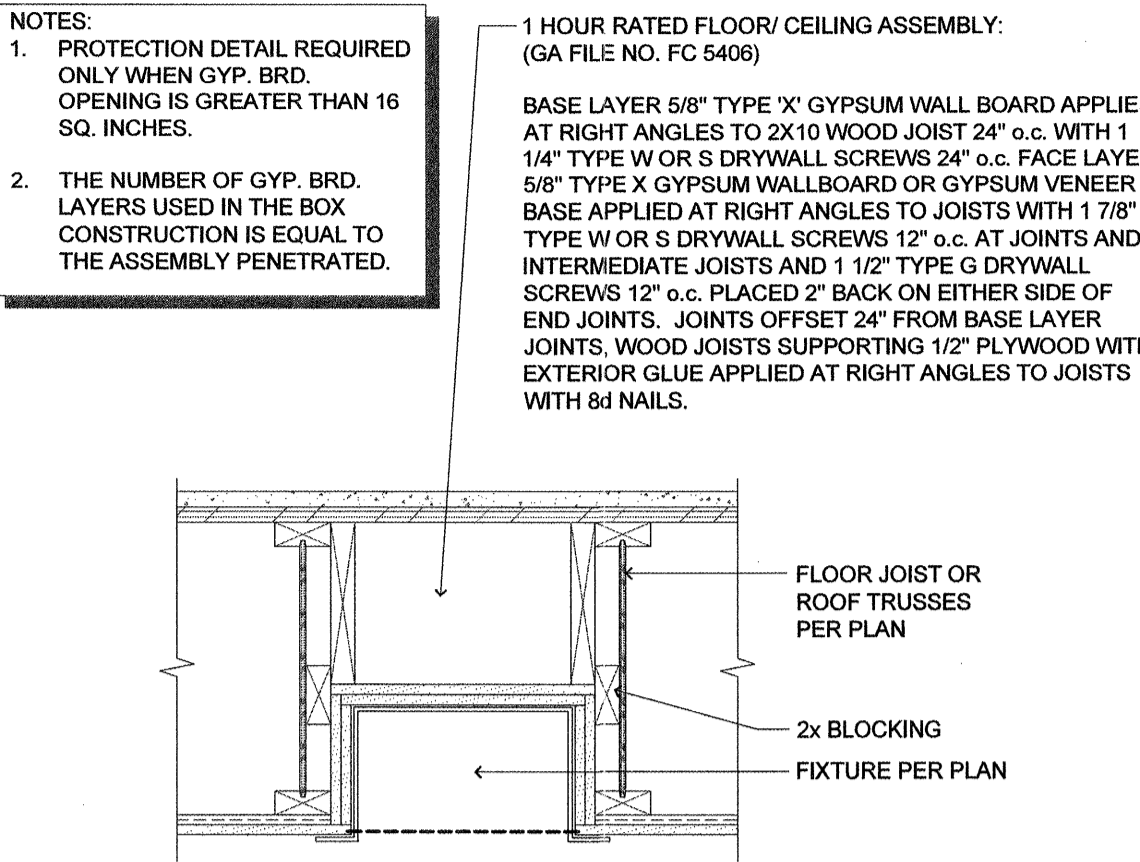

6 SECTION AT CORRIDOR
(ALL TRADES TO COORDINATE AVAILABLE SPACE)
SCALE: 1-1/2" = 1'-0"

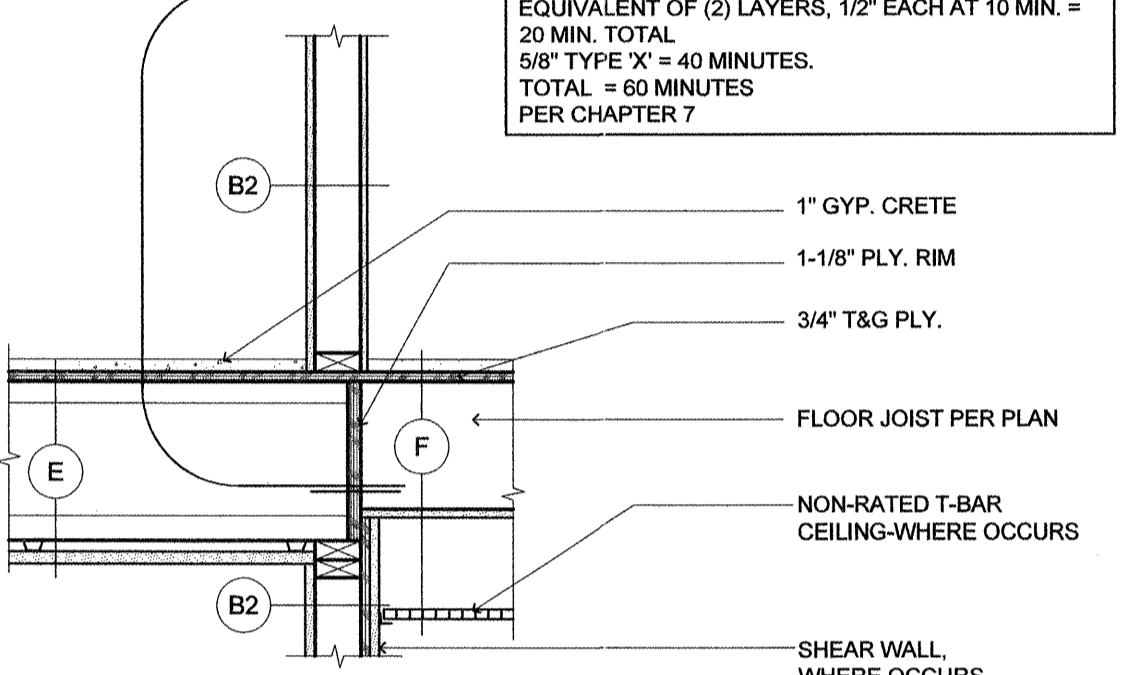

5 ELEC. PANEL (FIRE RATED)
SCALE: N.T.S.

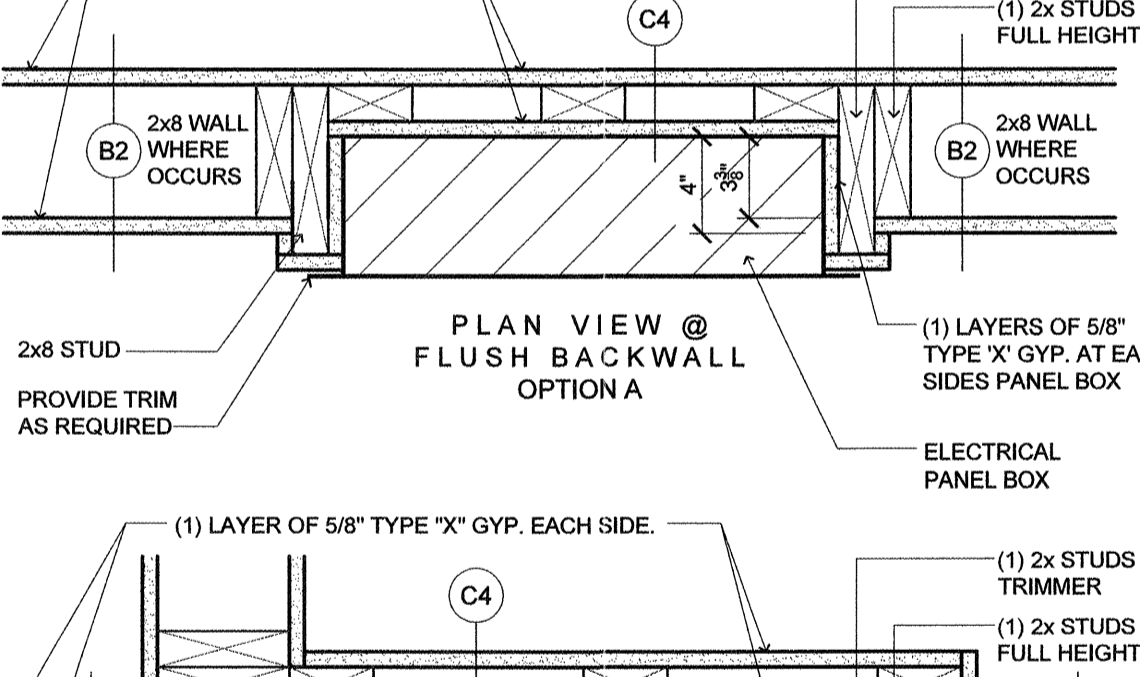

8 INT. WALL ASSEMBLY
(1 HR MECHANICAL CHASE)
SCALE: 1-1/2" = 1'-0"

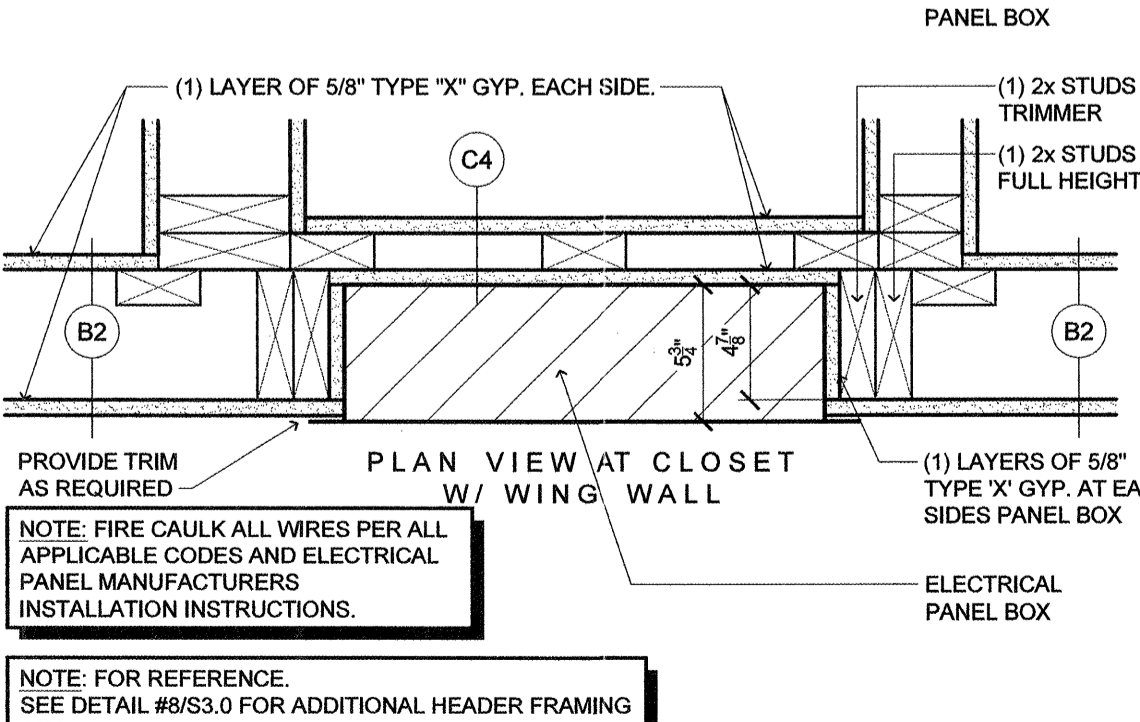

1 PLUMBING DETAIL
(AT FIRE RATED CONSTRUCTION)
SCALE: N.T.S.

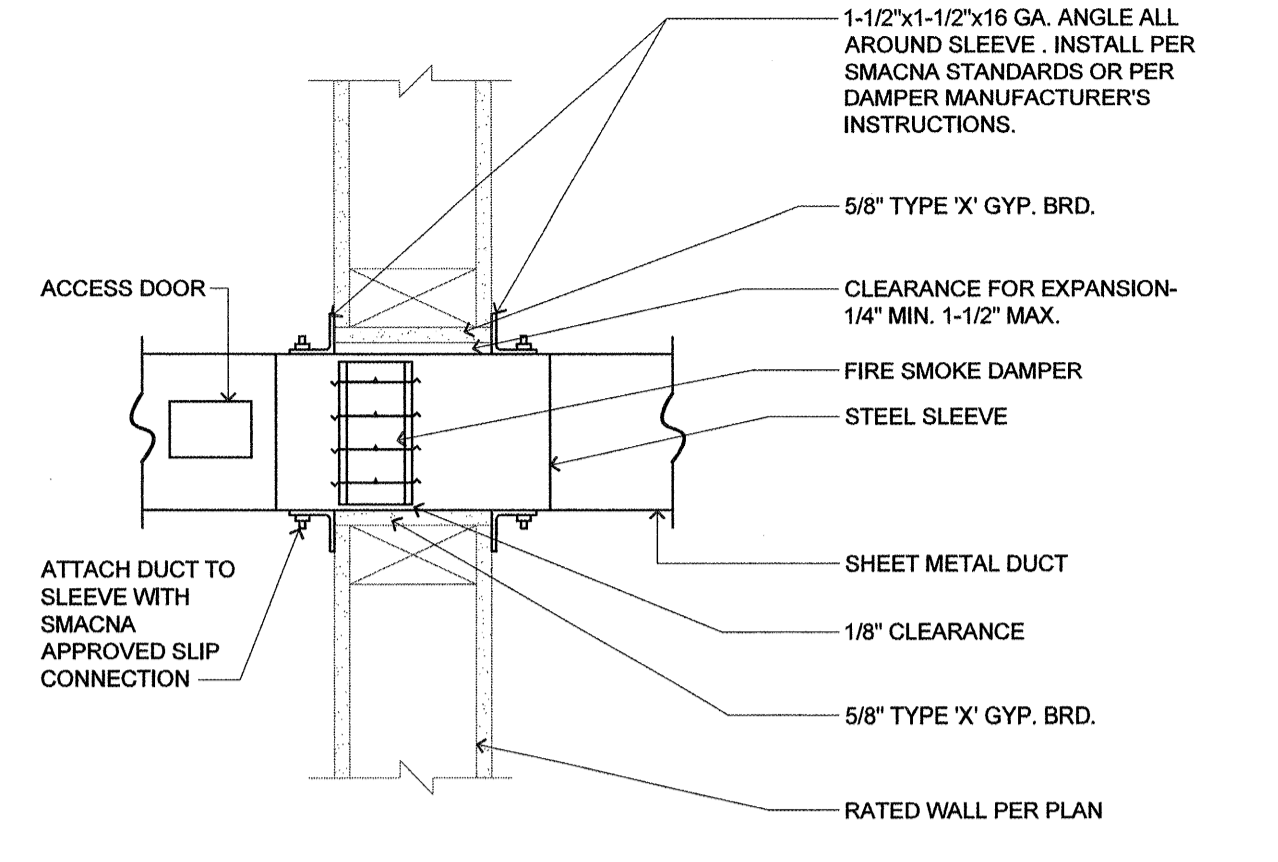

7 FIXTURE PROTECTION
HEAT LAMP, LIGHT FIXTURE/SPEAKER
SCALE: N.T.S.

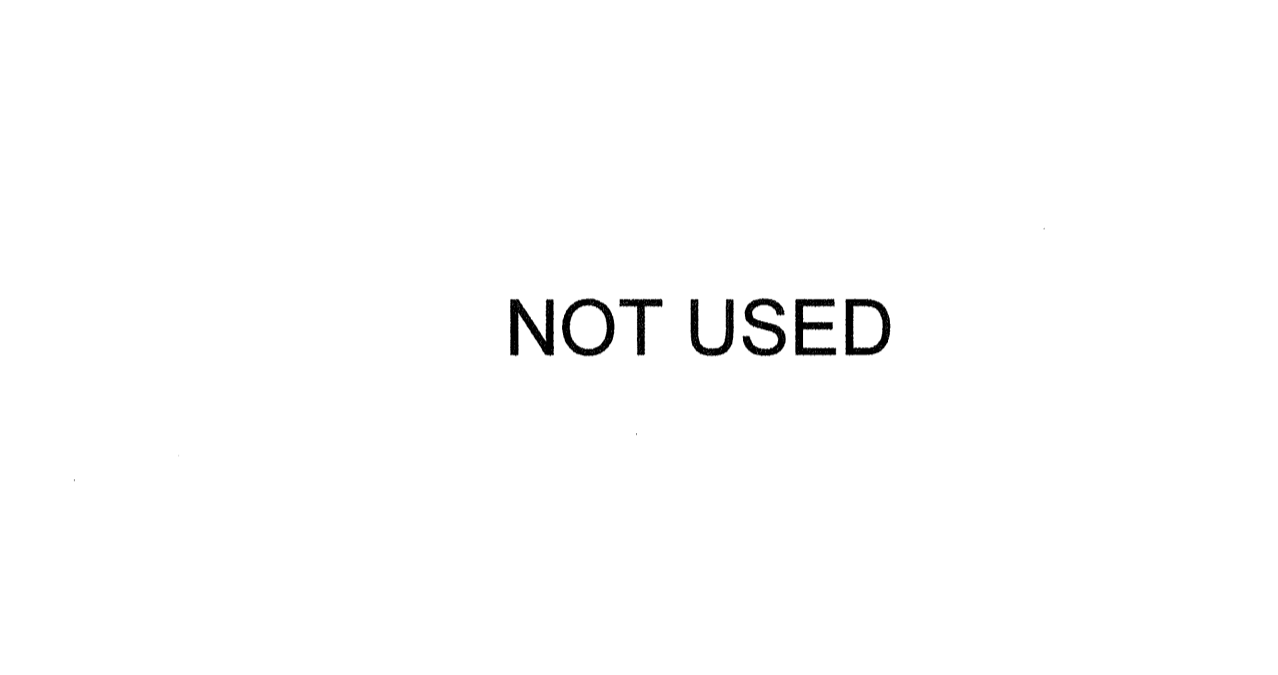

4 FIRE/SMOKE DAMPER IN WALL
SCALE: N.T.S.

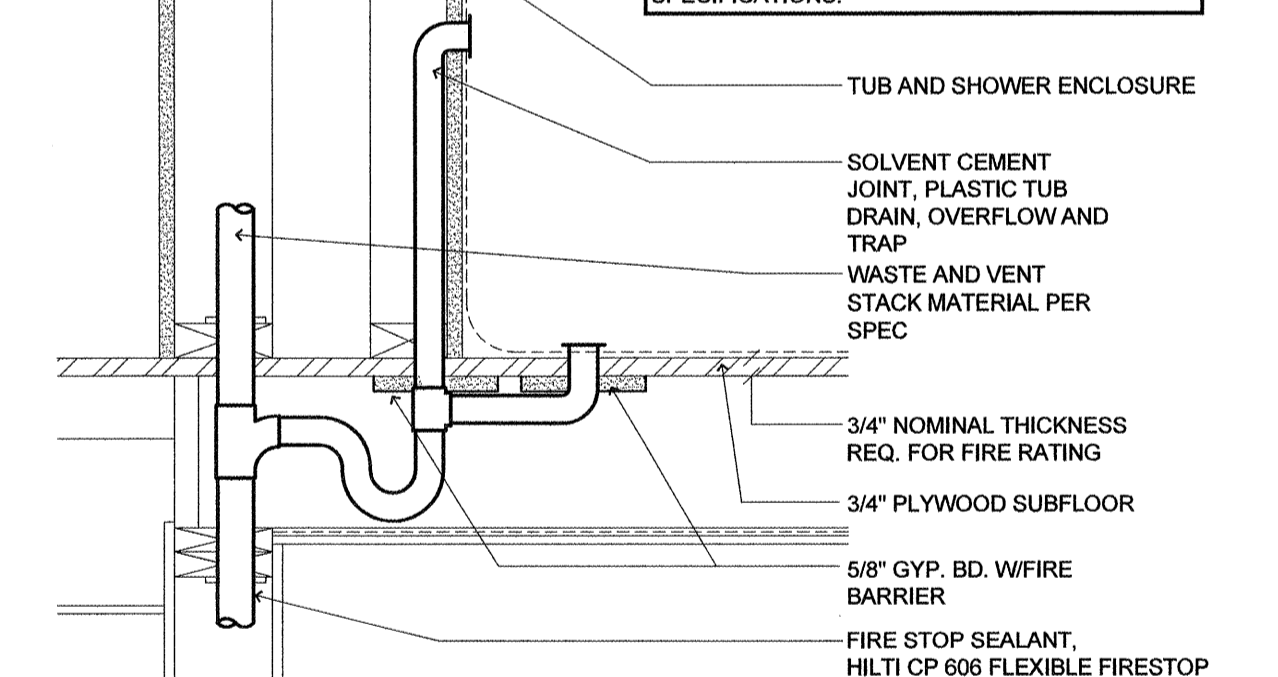

3 SECTION AT CORRIDOR
(ALL TRADES TO COORDINATE AVAILABLE SPACE)
SCALE: 1-1/2" = 1'-0"

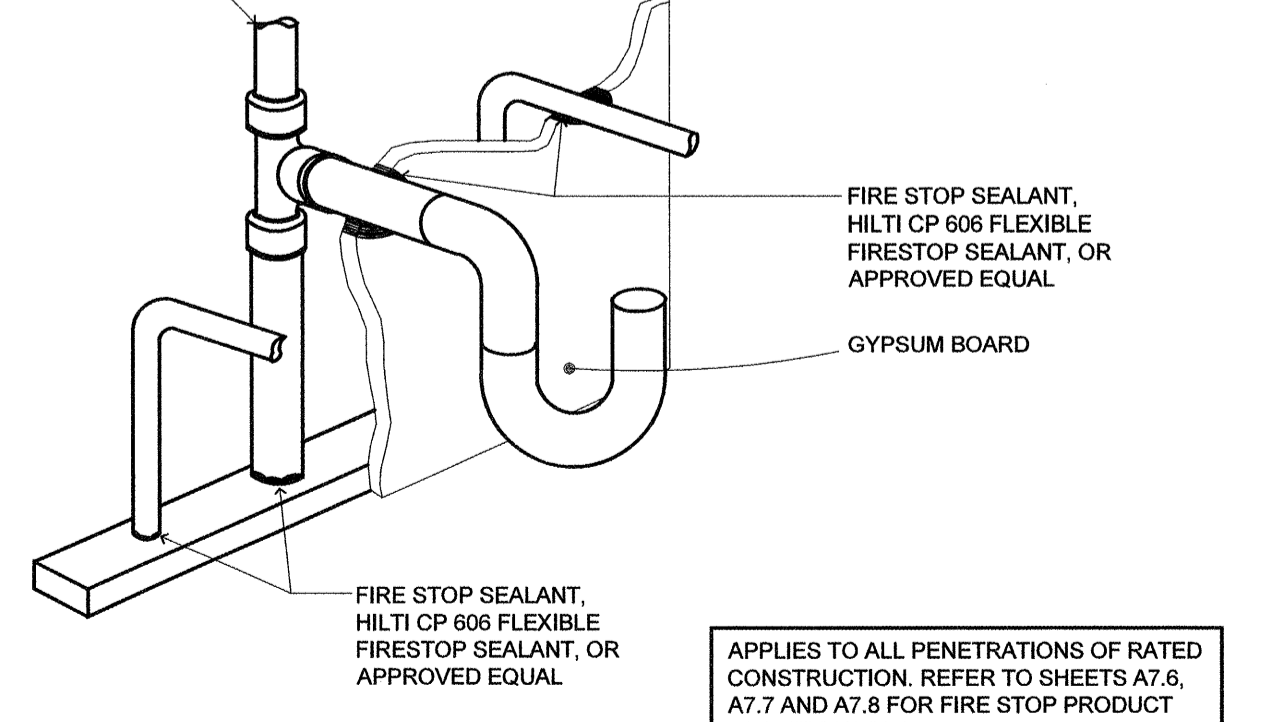

2 TUB AND SHOWER DRAIN DETAIL
SCALE: N.T.S.



1 PLUMBING DETAIL
(AT FIRE RATED CONSTRUCTION)
SCALE: N.T.S.

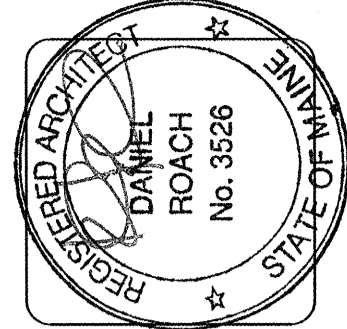

lenity architecture
3150 Nette Court, SE, Salem, Oregon 97301
P 503 399 0990 F 503 399 0585 W lenityarchitecture.com

COLSON AND COLSON
GENERAL CONTRACTOR, INC.
2280 McGILCHRIST STREET SE, SUITE 200
SALEM, OREGON, 97302
PHONE (503) 586-7401

PORTLAND RETIREMENT RESIDENCE
802 OCEAN AVE. PORTLAND, MAINE 04103

FIRE RATED CONSTRUCTION DETAILS

DATE: 8/28/2015
REVISED DATE:
9/22/2015
2/2/2016
7/18/2016

SHEET
A8.8