

20 INSUL. BAFFLE
(AT DECK AND OVERHANGS GREATER THAN 24")
SCALE: 3/4" = 1'-0"

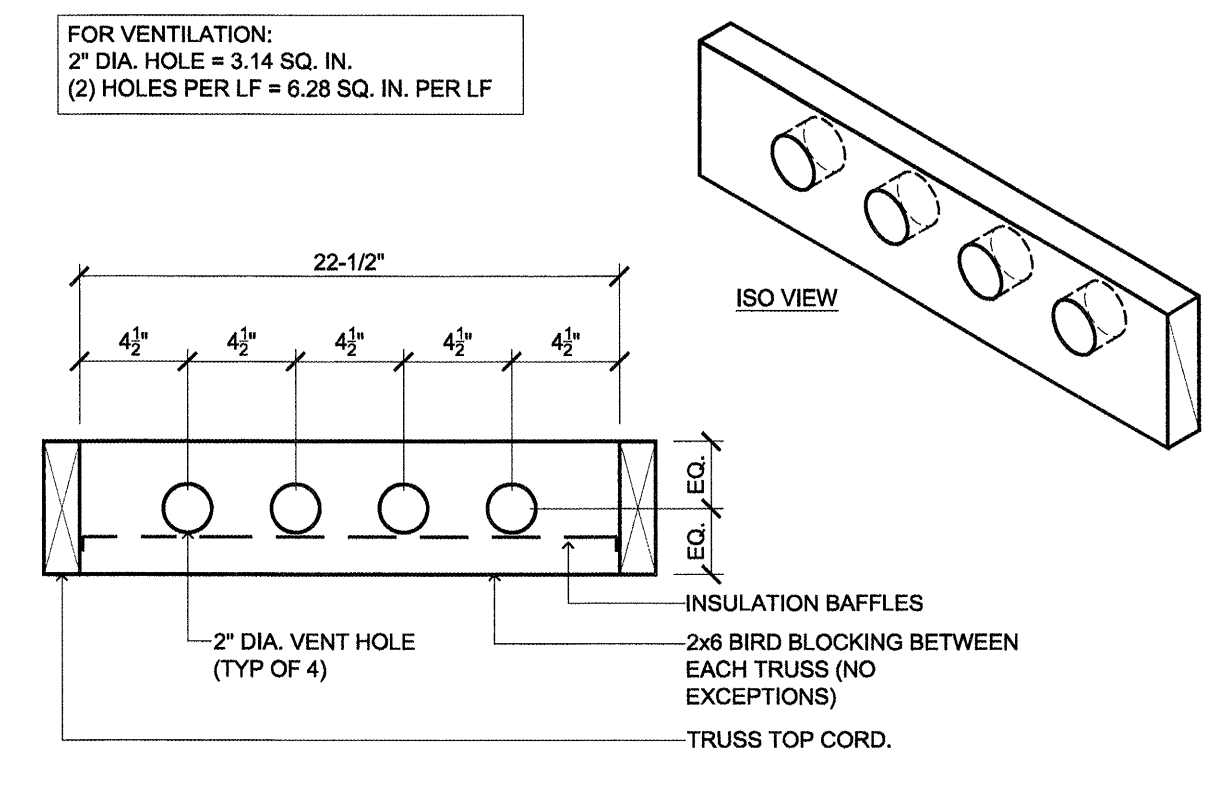

15 DECK DRAIN
(DECK DETAIL)
SCALE: 3" = 1'-0"

19 EXTERIOR EAVE BLOCKING
(TRUSSES BEARING ON WALL TOP PLATE)
SCALE: 1-1/2" = 1'-0"

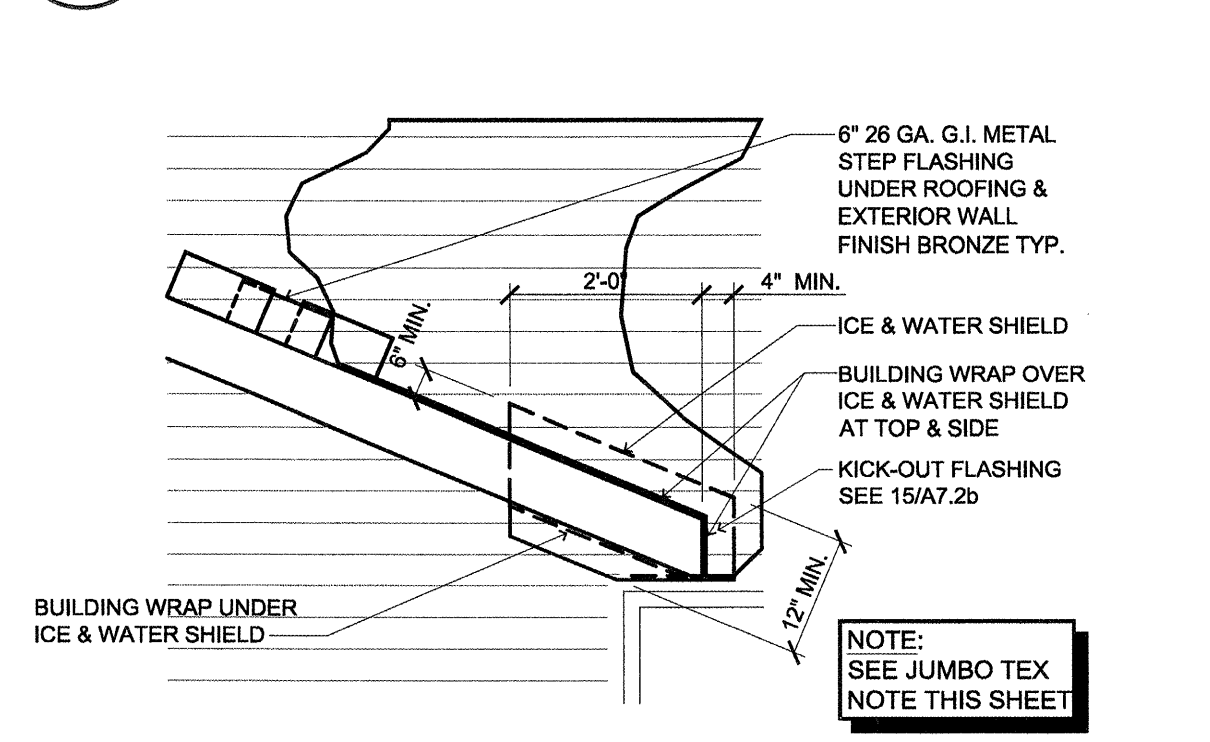

18 ROOF FLASHING
SCALE: 1/2" = 1'-0"

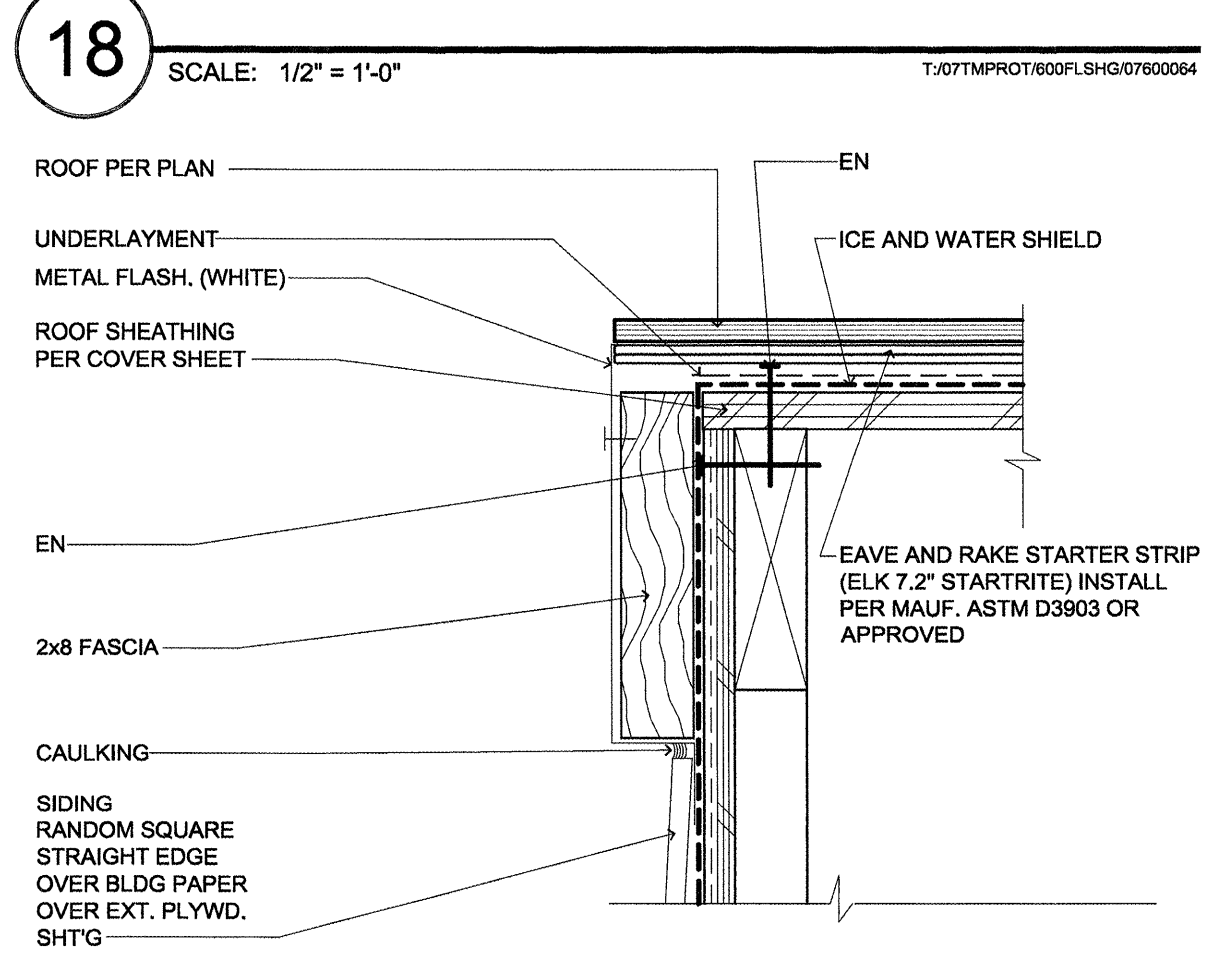

17 RAKE DETAIL
(AT PARAPET WALL)
SCALE: 3" = 1'-0"

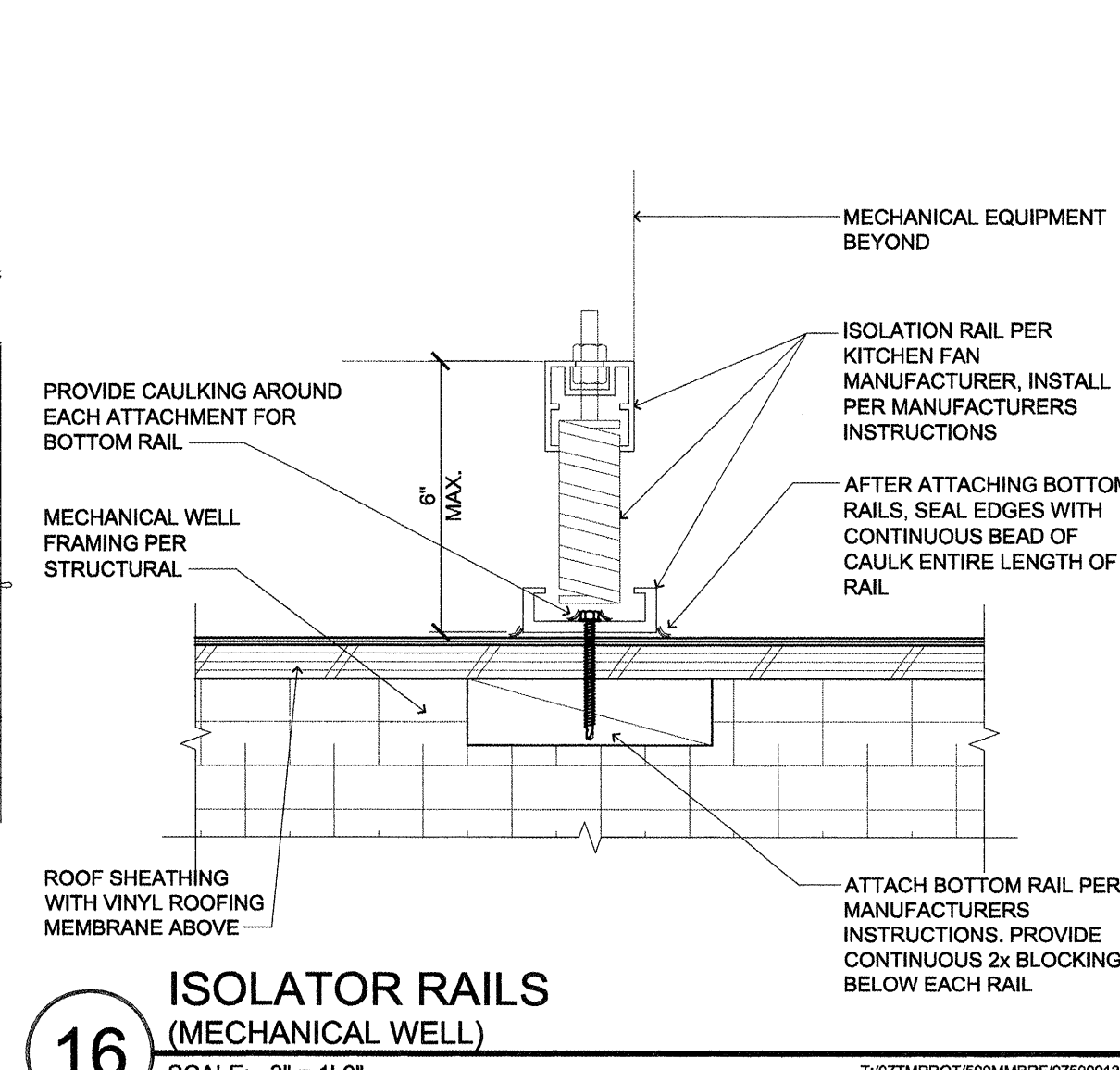

16 ISOLATOR RAILS
(MECHANICAL WELL)
SCALE: 3" = 1'-0"

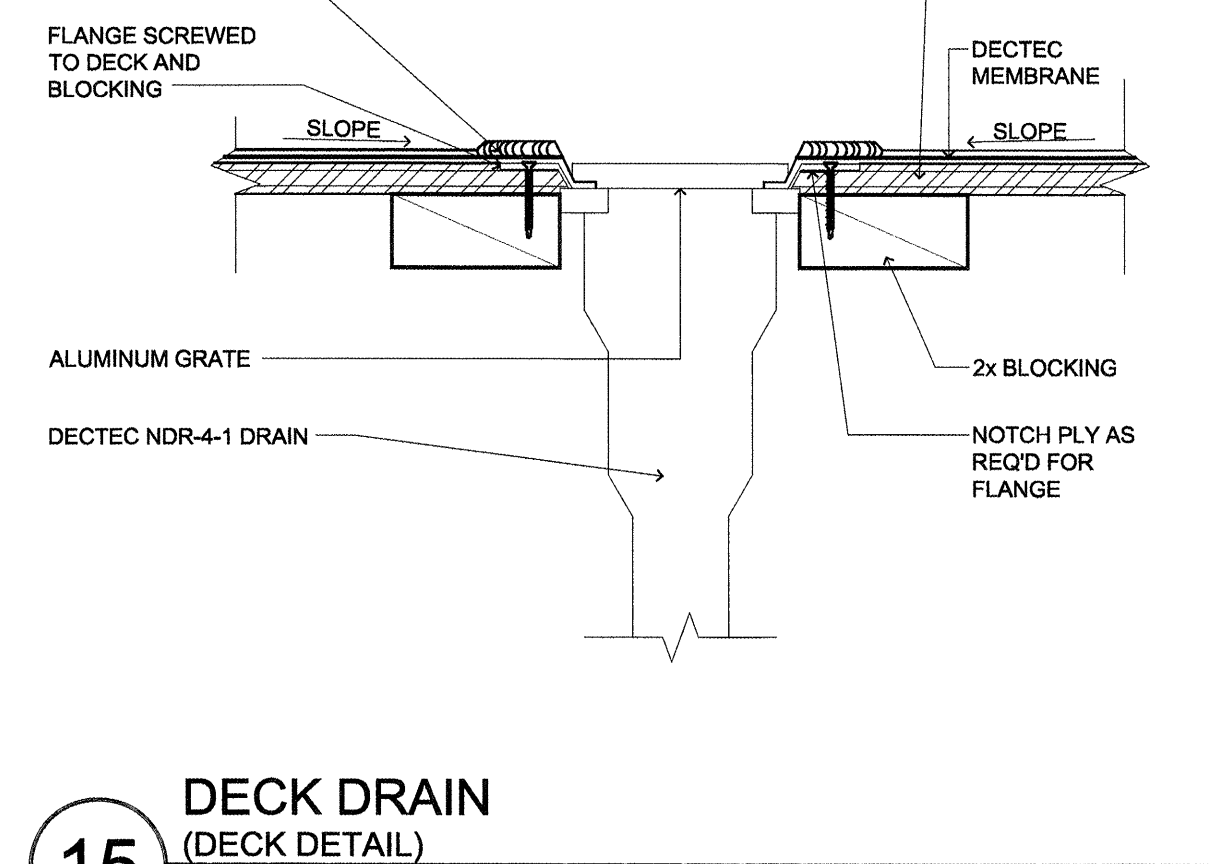

11 STEP FLASHING
(DORMER WALL INTERSECT)
SCALE: N.T.S.

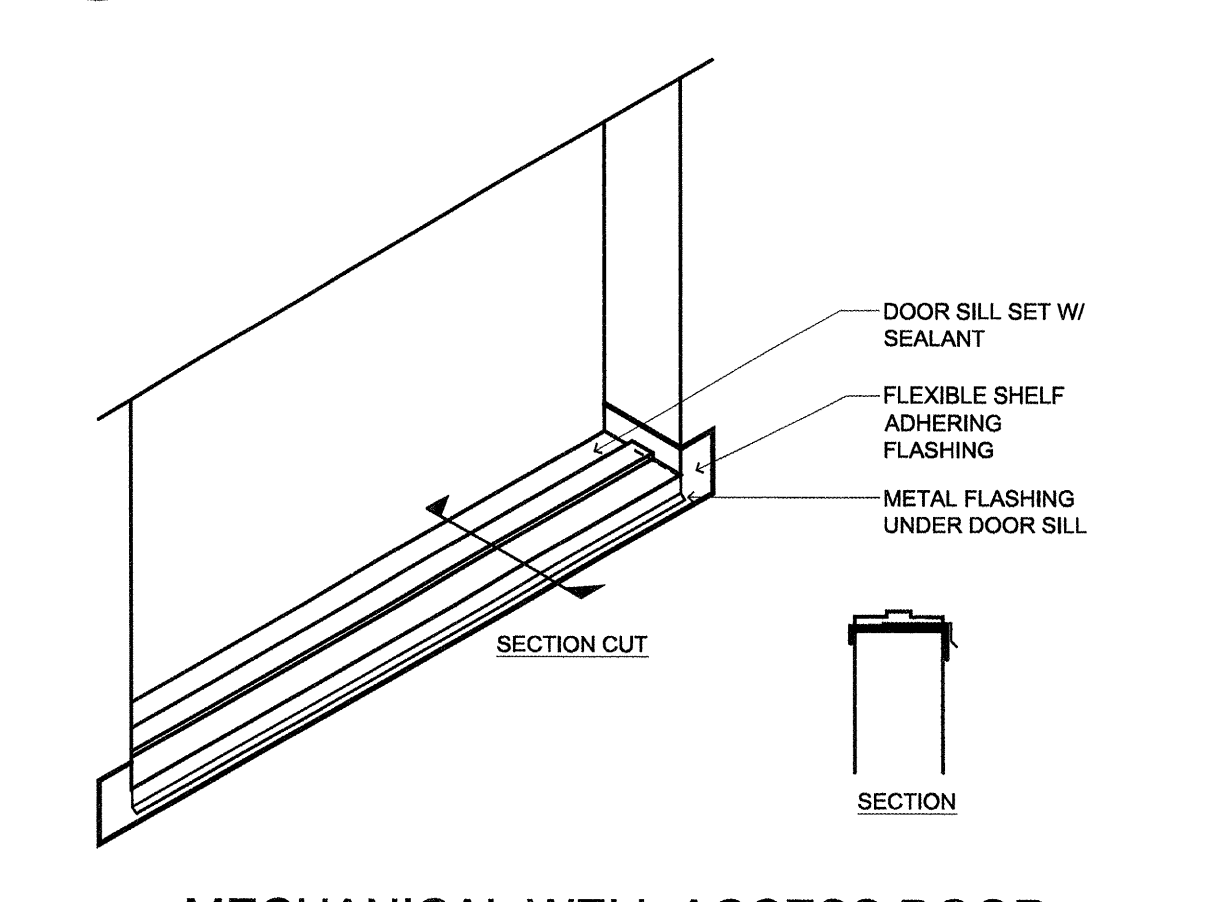

14 MECHANICAL WELL ACCESS DOOR
(SILL DETAIL)
SCALE: 1" = 1'-0"

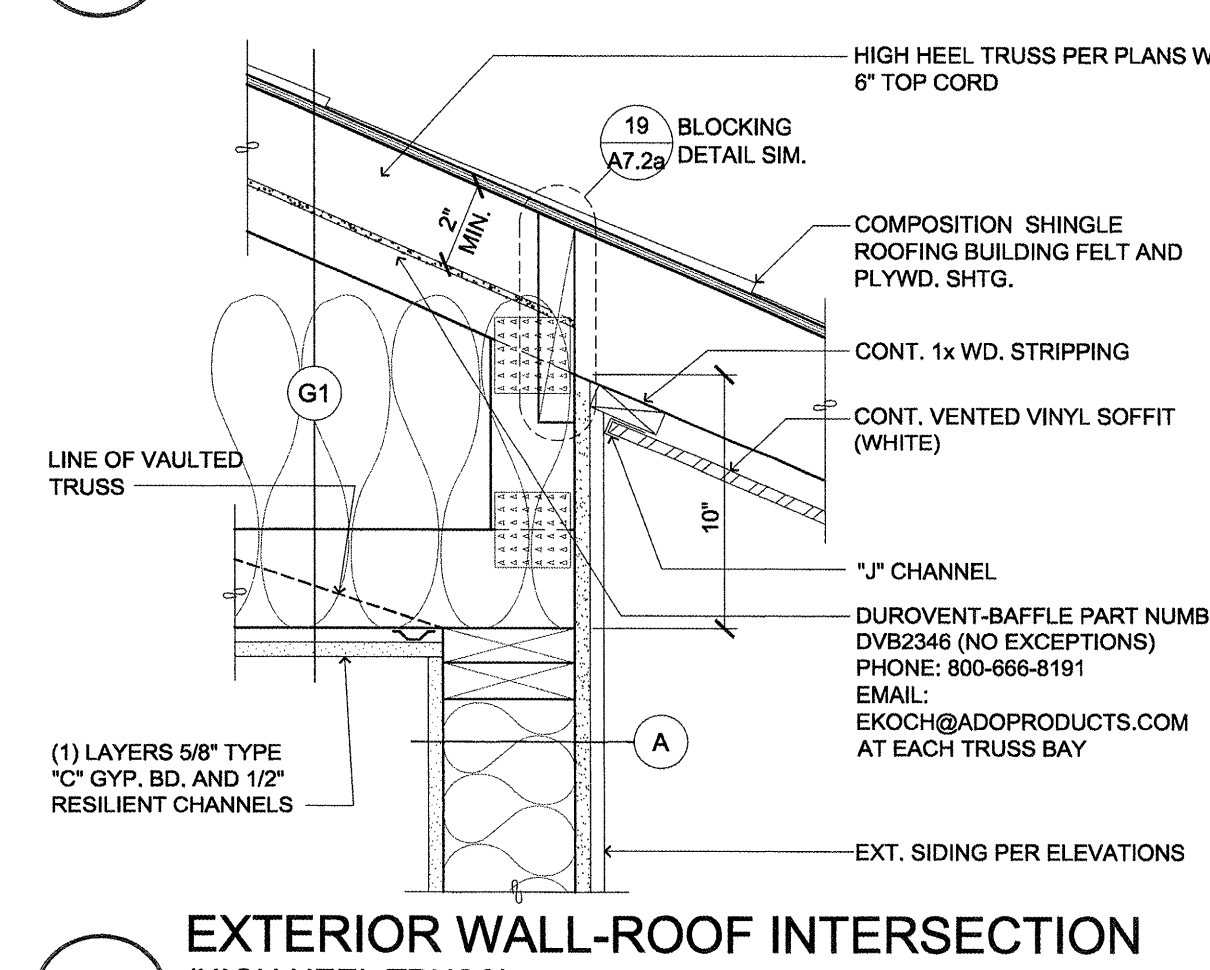

13 EXTERIOR WALL-ROOF INTERSECTION
(HIGH HEEL TRUSSES)
SCALE: N.T.S.

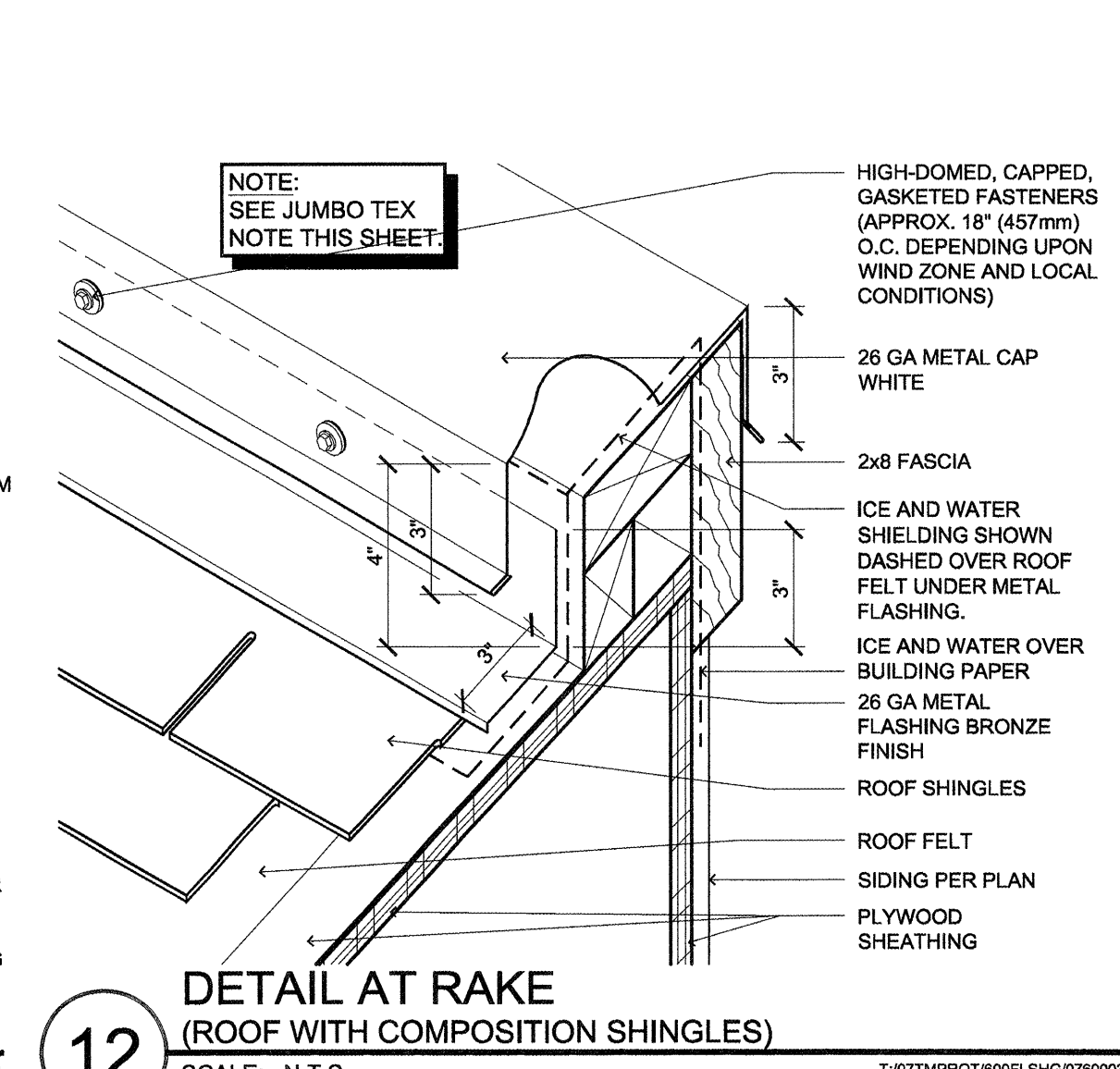

12 DETAIL AT RAKE
(ROOF WITH COMPOSITION SHINGLES)
SCALE: N.T.S.

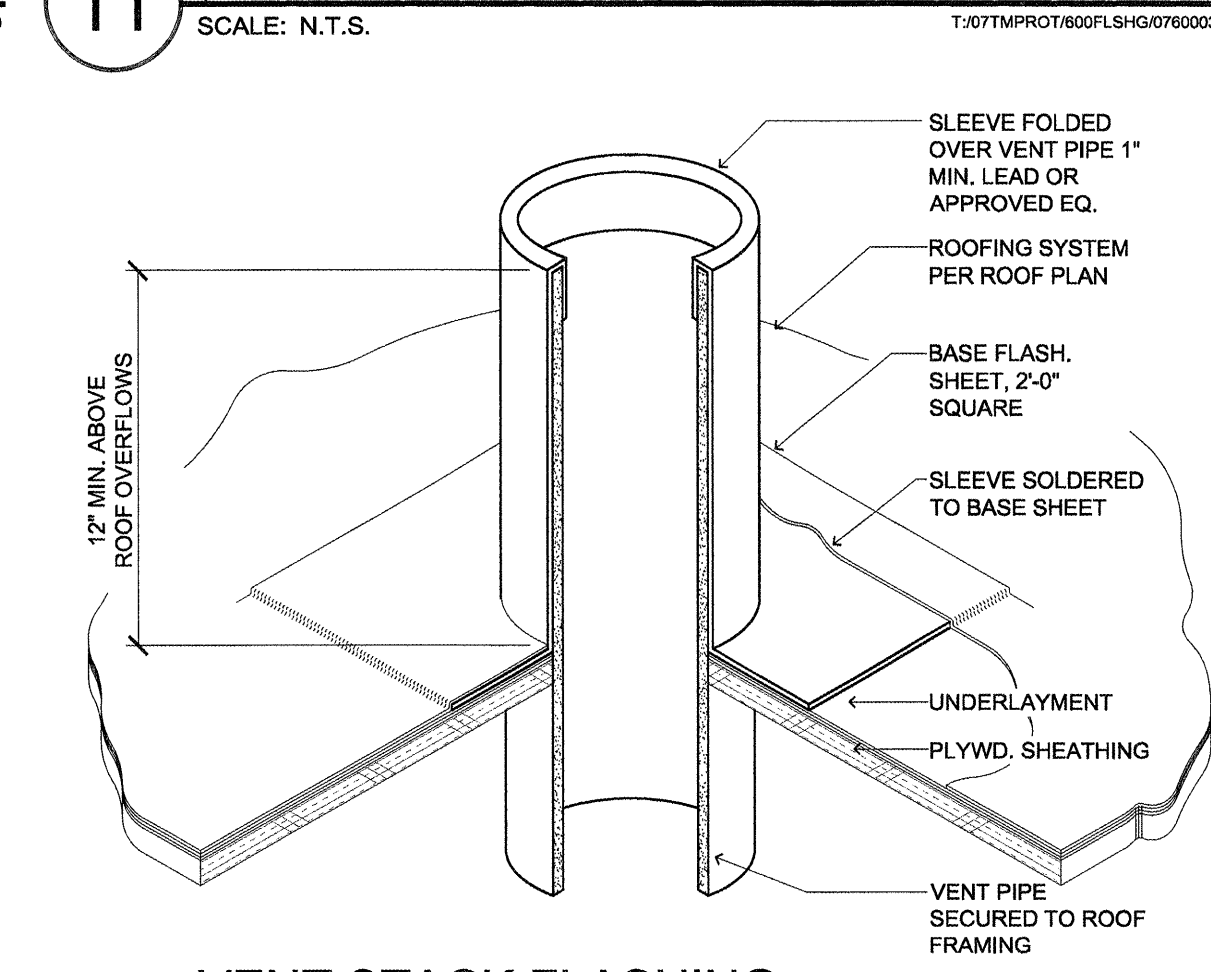
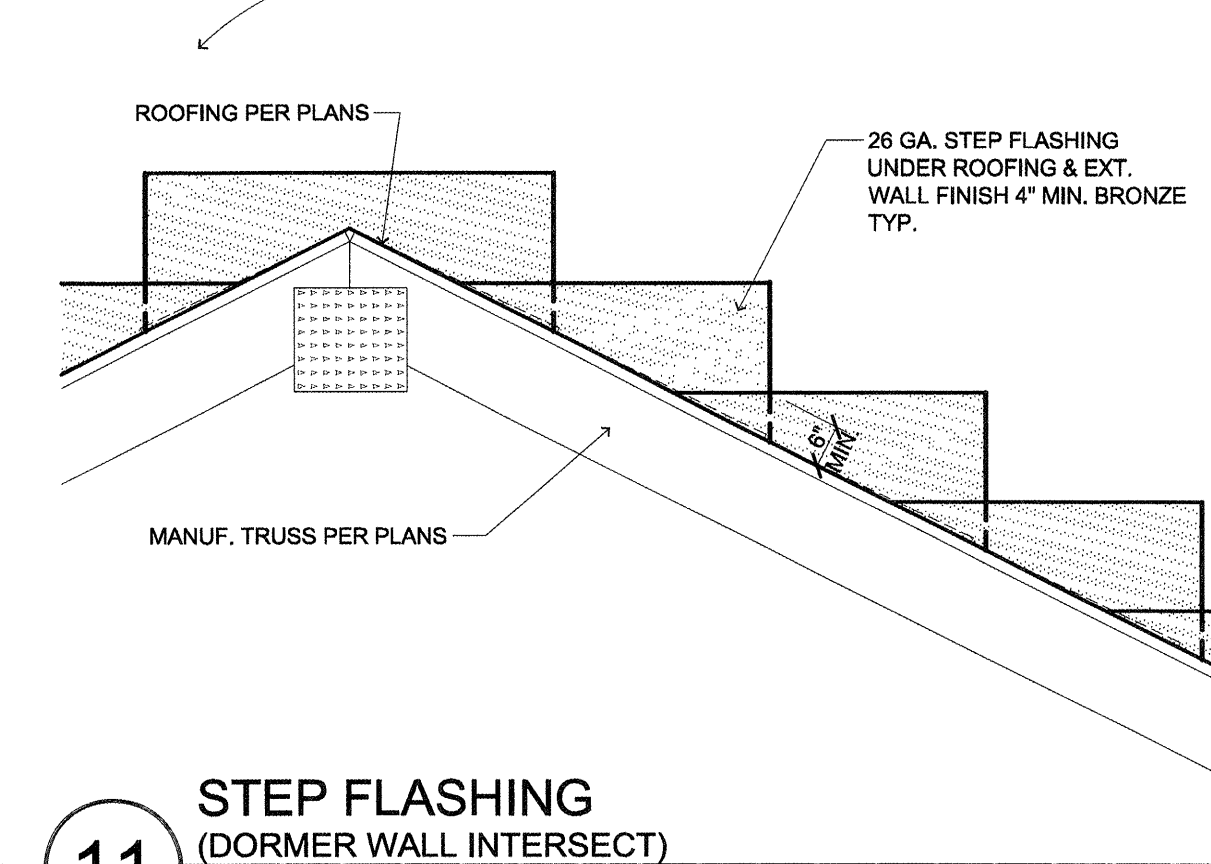

10 VENT STACK FLASHING
SCALE: N.T.S.

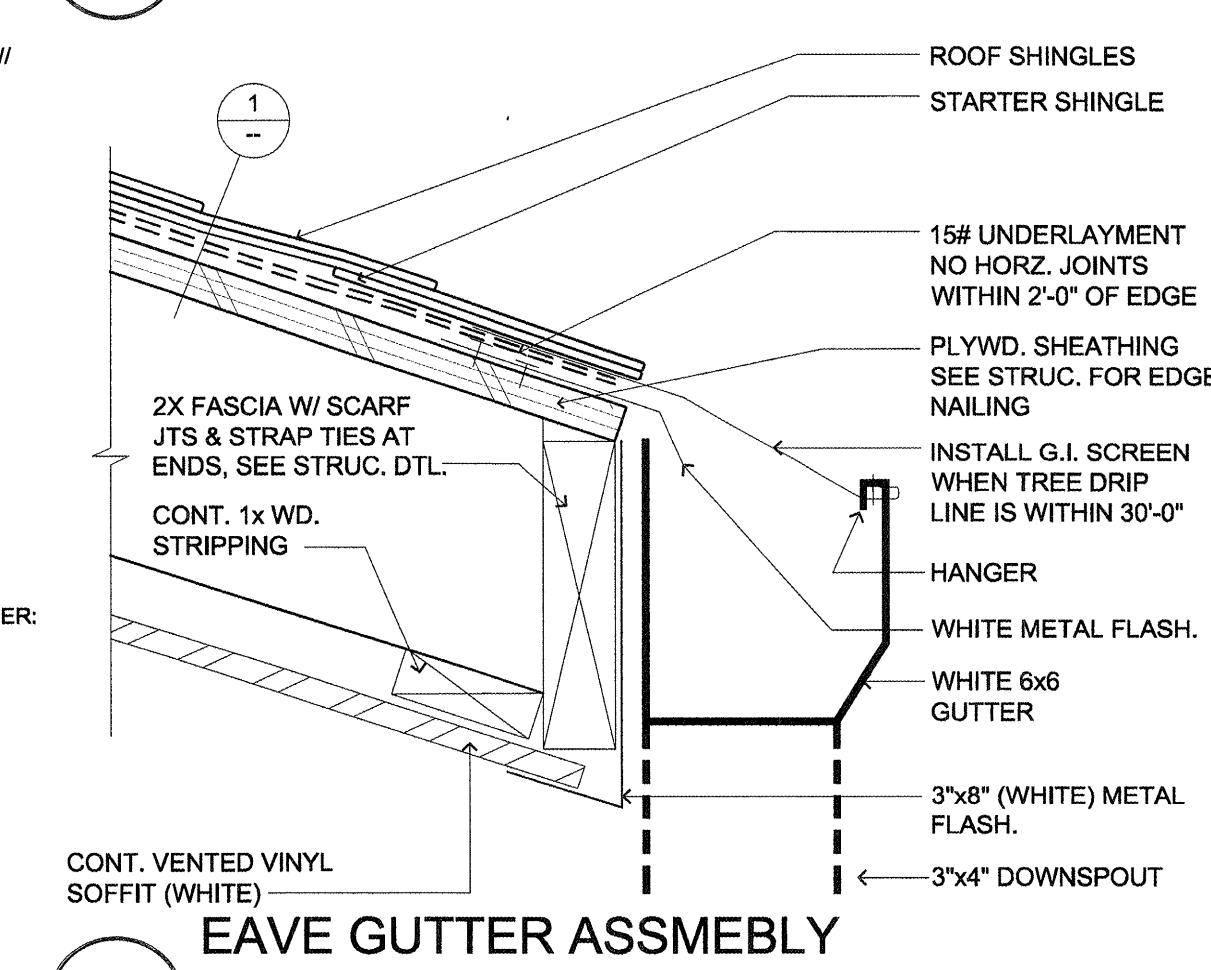

9 EAVE GUTTER ASSEMBLY
(ROOF WITH COMPOSITION SHINGLES)
SCALE: 3" = 1'-0"

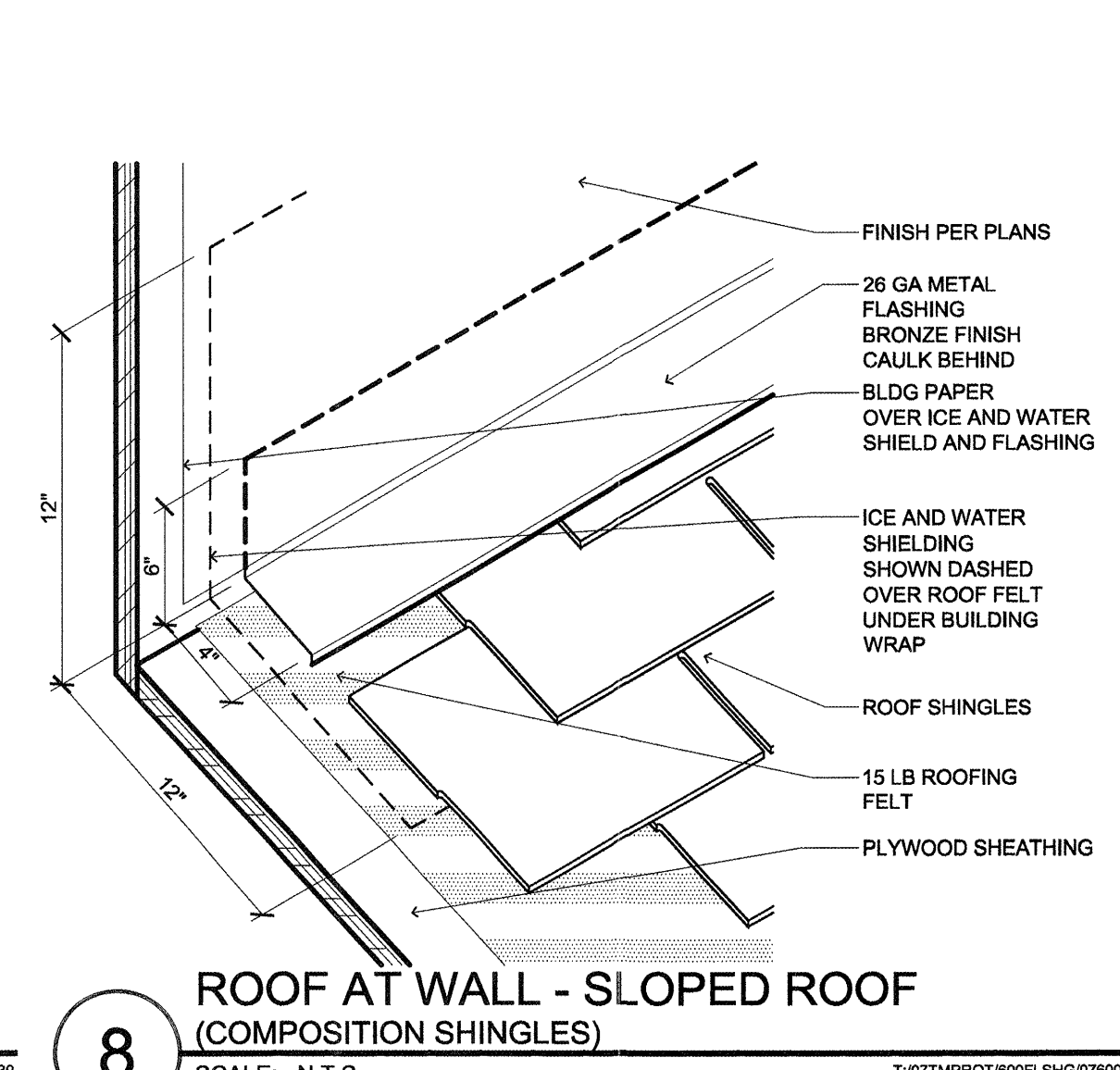

8 ROOF AT WALL - SLOPED ROOF
(COMPOSITION SHINGLES)
SCALE: N.T.S.

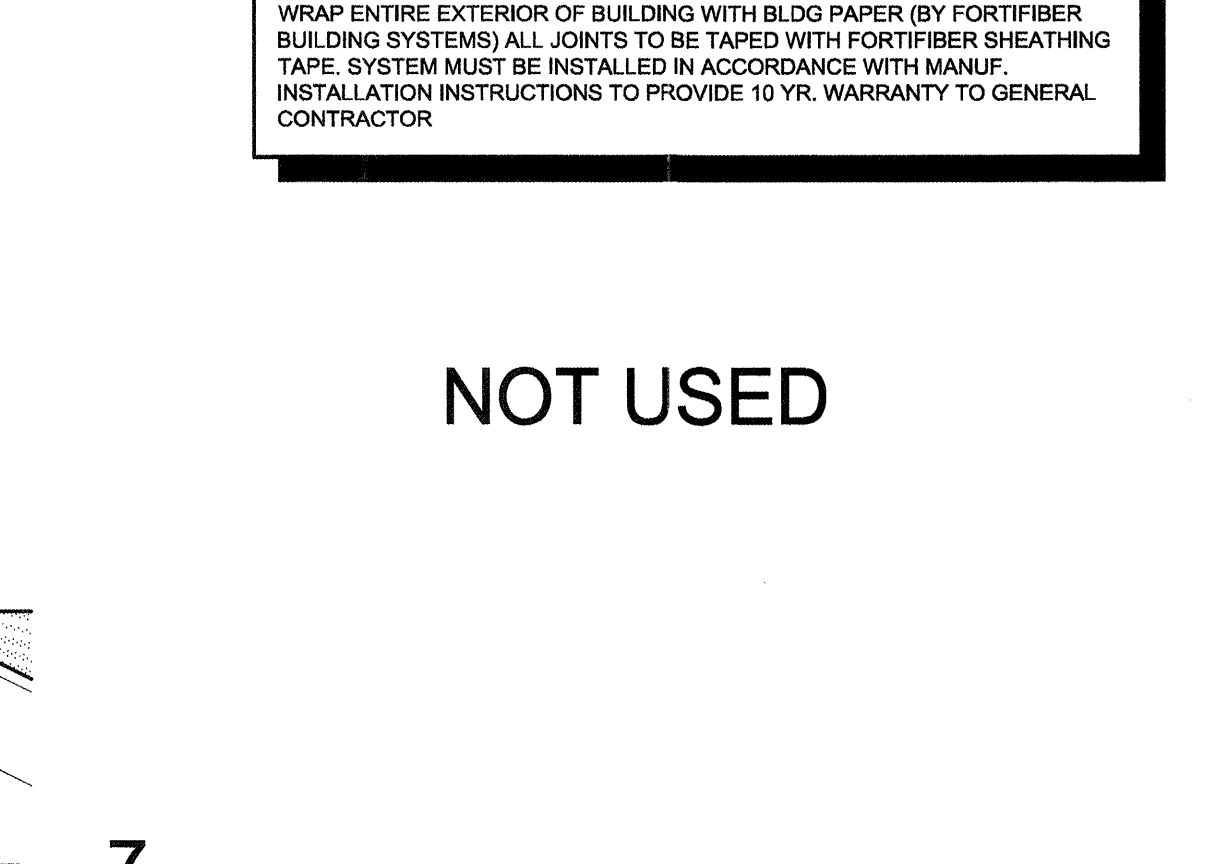

6 AREA ROOF DRAIN/OVERFLOW DRAIN
(BUILT-UP ROOFING)
SCALE: N.T.S.

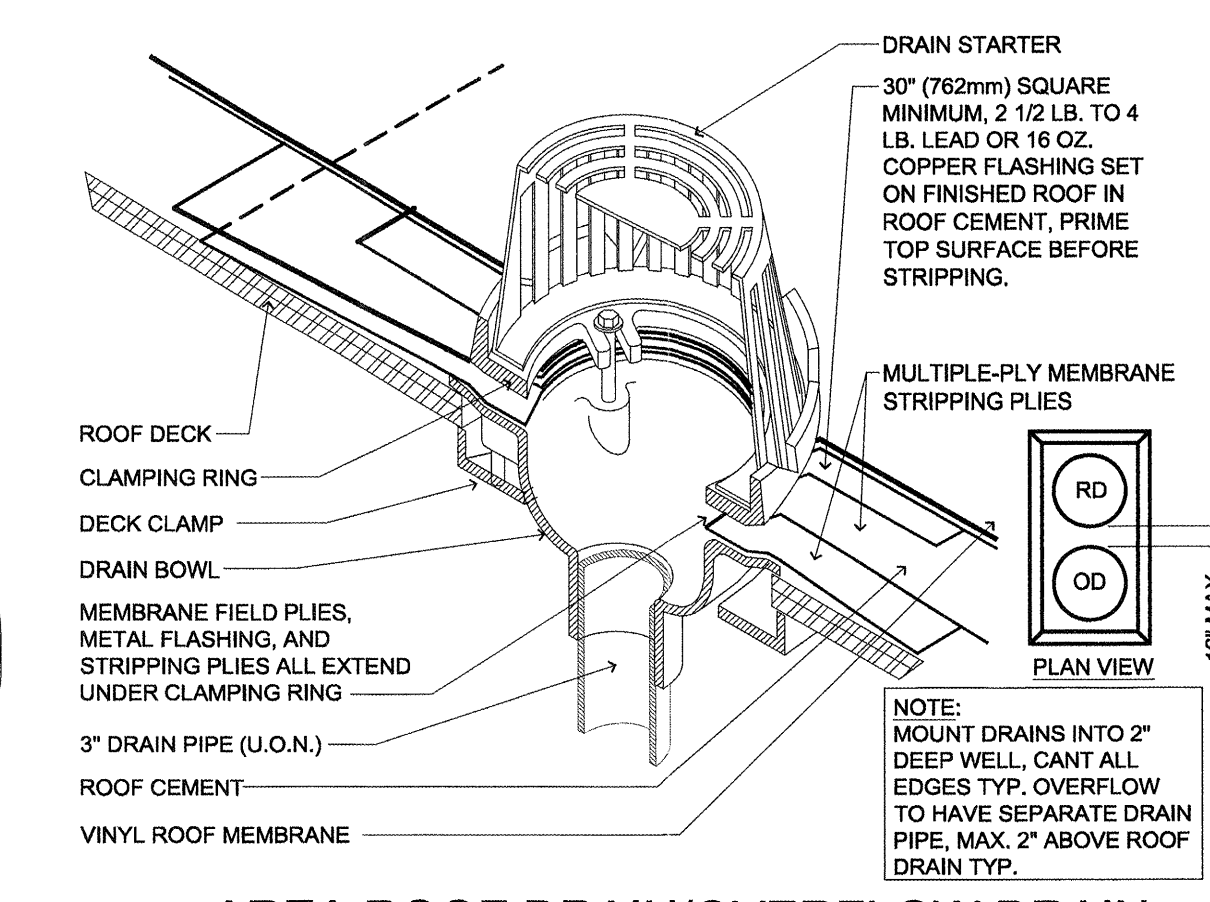

5 WOVEN VALLEY
(COMPOSITION SHINGLES)
SCALE: 3" = 1'-0"

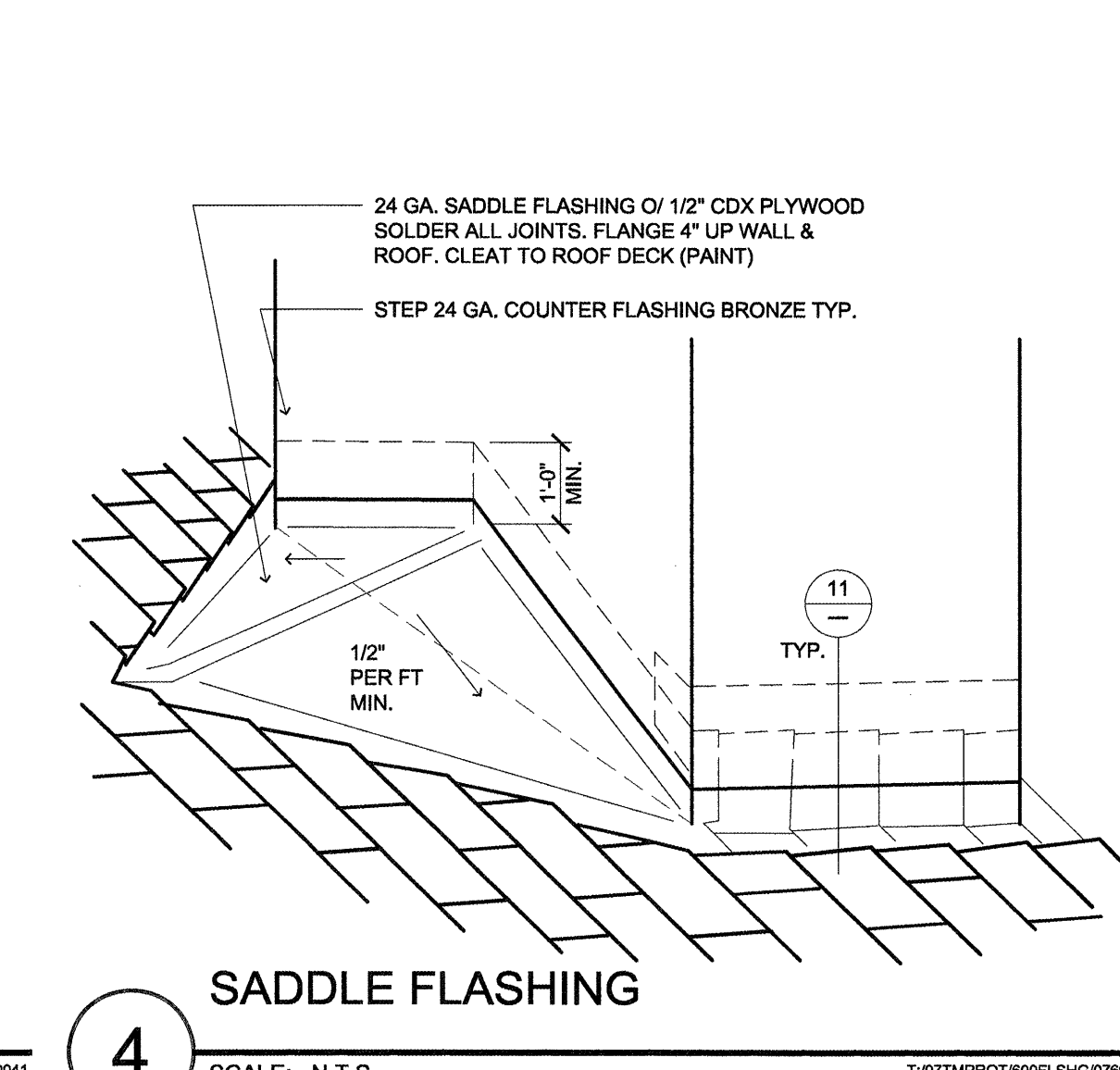

4 SADDLE FLASHING
SCALE: N.T.S.

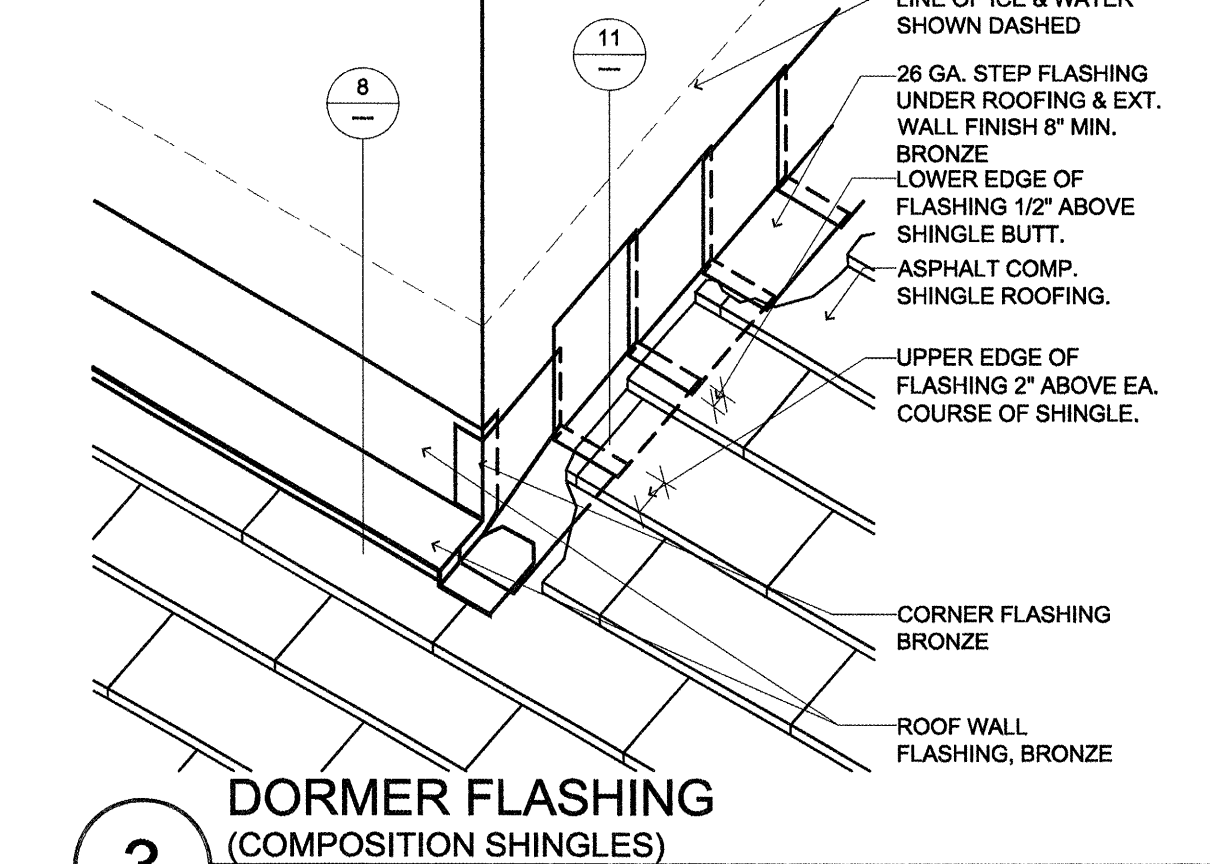

3 DORMER FLASHING
(COMPOSITION SHINGLES)
SCALE: N.T.S.

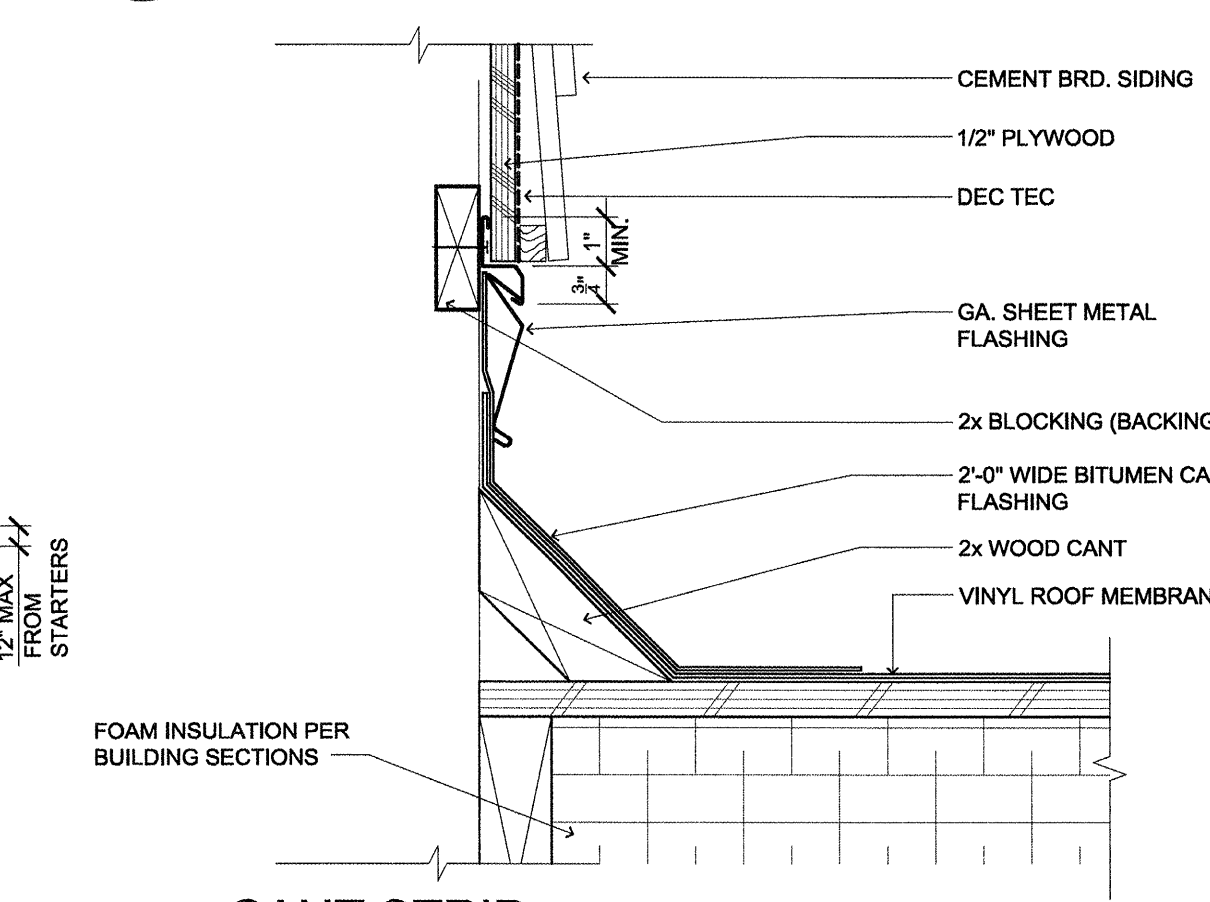

2 CANT STRIP
(BUILT-UP ROOFING)
SCALE: 3" = 1'-0"

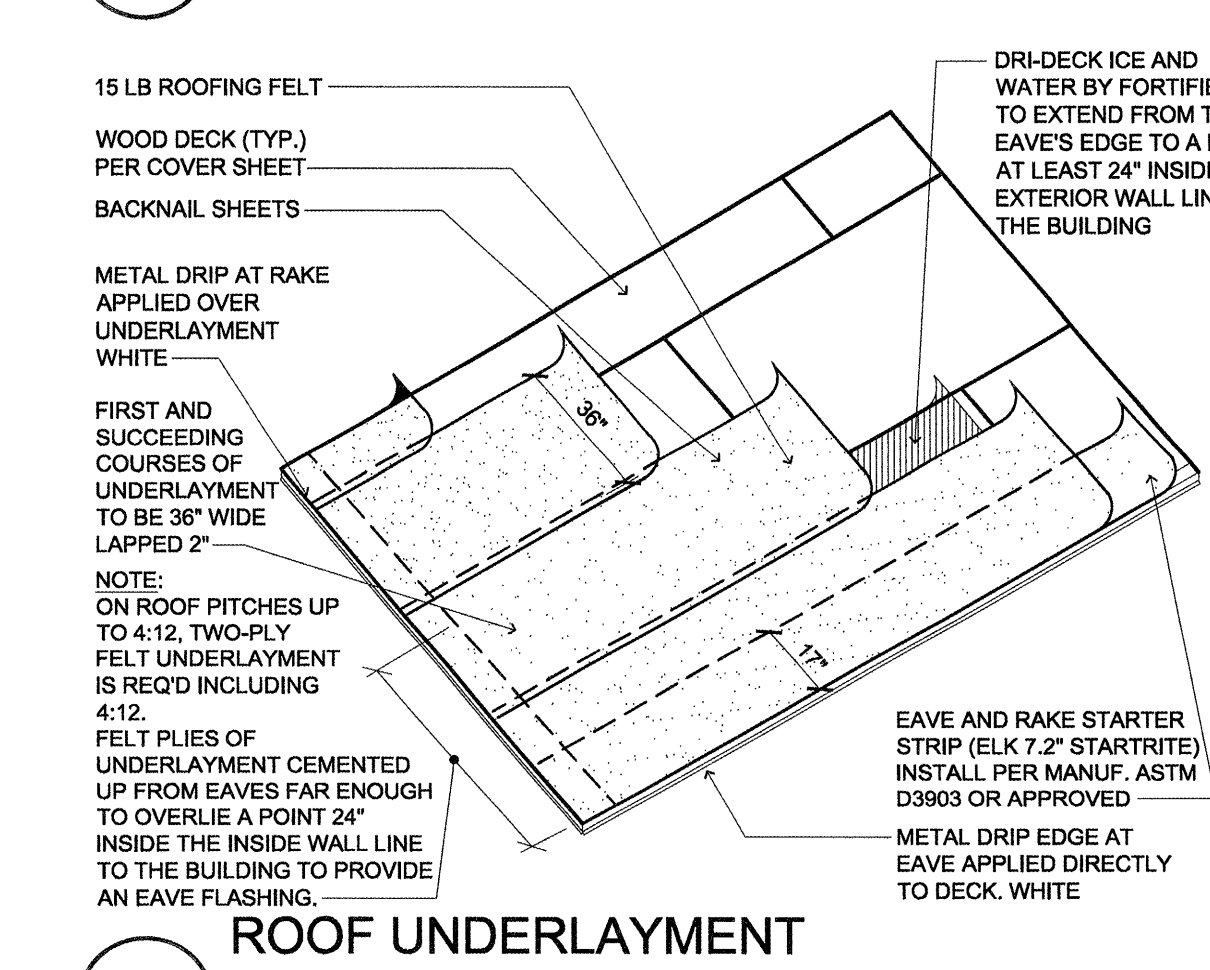

1 ROOF UNDERLAYMENT
(ASSEMBLY DETAIL)
SCALE: N.T.S.

lenity
architecture

3150 Kettle Court, SE, Salem, Oregon 97301
P: 503.399.1090 F: 503.399.0285

COLSON AND COLSON
GENERAL CONTRACTOR, INC.
2280 McILCHRIST STREET, SUITE 200
SALEM, OREGON 97302
PHONE (503) 586-7401

PORTLAND
RETIREMENT RESIDENCE
802 OCEAN AVE., PORTLAND, MAINE 04103

ROOF DETAILS

DATE: 8/28/2015
REVISED DATE:
SHEET: A7.2a