

Filing Category: ROOF COVERING AND ROOF DECK CONSTRUCTION—Roof Covering

FIRE-RETARDANT-TREATED WOOD SHAKES AND SHINGLES

CHEMCO, INC.
POST OFFICE BOX 875
FERNDALE, WASHINGTON 98248

1.0 SUBJECT

FTX, CEDARPLUS, Durashake®, FST and Chemco Fire-retardant-treated Wood Shakes and Shingles.

2.0 DESCRIPTION

2.1 General:

The fire-retardant-treated wood shakes and shingles are produced from No. 1 grade western red cedar shakes or shingles complying with UBC Standard 15-3 or 15-4. The shakes and shingles, having a maximum moisture content of 25 percent, are pressure-treated by Chemco, Inc., with proprietary fire-retardant chemicals. Fire-retardant-treated starter course materials are supplied by Chemco, Inc., and are produced from No. 2 grade taper sawn shakes or No. 2 shingles complying with UBC Standard 15-3 or 15-4, respectively. Products are sold under the trade names FTX, CEDARPLUS, Durashake, FST and Chemco.

2.2 Installation:

2.2.1 General: The wood shakes and shingles are installed on spaced or solid sheathing complying with the 1997 *Uniform Building Code*™ (UBC). The shakes and shingles are installed in accordance with Table 15-B-2 of the code except as noted in this report. On roof slopes from 3:12 (25% slope) to less than 4:12 (33.33% slope), installation requires one layer of Type 15 asphalt-saturated felt. In addition to the interlayerment between courses, shakes are installed with an underlayment of 36-inch-wide (914 mm), Type 30 asphalt-saturated felt under the 15- or 18-inch-long (381 or 457 mm) starter course at the eave line. Valley flashing must comply with Section 1508.5 of the UBC, and other flashing must comply with Section 1509. Maximum weather exposure of the shakes and shingles must not exceed those exposures in Table 15-C of the UBC. Weather exposure of hips and ridges must not exceed those exposures permitted for the field of the roof. Starter courses at the eave are doubled using 3/4-inch-by-15-inch (19.1 mm by 381 mm) or 1-inch-by-15 inch (25.4 mm by 381 mm) starter-course shakes or shingles, supplied by Chemco, Inc. Fifteen-inch (381 mm) or 18-inch (457 mm) shakes or shingles may be used for the final course at the ridge. See Figure 1 for typical installation details.

2.2.2 Class A Roof Covering: Products labeled as "Class B" shakes or shingles are installed in accordance with Section 2.2.1 of this report, over spaced or solid sheathing covered either with one layer of 1/4-inch-thick (6.4

mm) Dens-Deck® Roof Board, manufactured by Georgia-Pacific Corporation, or with one layer of 72-pound mineral-surfaced cap sheet. Fastener length must be increased for the thickness of the Dens-Deck board or cap sheet. The Dens-Deck boards are fastened to spaced or solid sheathing using a minimum of four fasteners per board to avoid panel shifting prior to installation of the shakes or shingles. The mineral-surfaced cap sheet is installed with 2-inch (51 mm) overlaps on sides and ends, and attached with a sufficient number of fasteners to hold the sheet in place prior to installation of the shakes or shingles.

2.2.3 Class B Roof Covering: Products labeled as "Class B" shakes or shingles are installed in accordance with Section 2.2.1 of this report.

2.2.4 Class C Roof Covering: Products labeled as "Class C" shakes or shingles are installed in accordance with Section 2.2.1 of this report.

2.3 Identification:

Bundles of treated wood shakes and shingles bear a label noting the shingle or shake grading agency and compliance with UBC Standard 15-3 or 15-4. An additional label is affixed to each bundle, and bears the treater's name (Chemco, Inc.), the product name, the name of the quality control agency (Fire Tech Services, Inc.), the fire classification and the evaluation report number (ICBO ES ER-5404). Labels for "Class B" shakes are printed with red ink and labels for "Class C" shakes are printed with blue ink. See Figure 2 for product labels.

Starter-course shingles and shakes are identified with a label bearing the treater's name (Chemco, Inc.), the product name (Starter-Course), the name of the quality control agency (Fire Tech Services, Inc.), the fire classification, the evaluation report number (ICBO ES ER-5404), and the words "To be used as starter-course only." Labels for "Class B" starter course materials are printed with orange ink and labels for "Class C" starter course materials are printed with purple ink. See Figure 3 for product labels.

Dens Deck Roof Board and mineral-surfaced fiberglass cap sheet must bear the label of a quality control agency accredited by ICBO ES.

3.0 EVIDENCE SUBMITTED

Reports of tests in accordance with the ICBO ES Acceptance Criteria for Fire-retardant-treated Wood Roof Systems (AC107), dated September 1997, quality control manual and installation instructions.

4.0 FINDINGS

That the fire-retardant-treated wood shakes and shingles described in this report comply with the 1997 Uniform Building Code™, subject to the following conditions:

ES REPORTS™ are not to be construed as representing aesthetics or any other attributes not specifically addressed, nor are they to be construed as an endorsement of the subject of the report or a recommendation for its use. There is no warranty by ICBO Evaluation Service, Inc., express or implied, as to any finding or other matter in this report, or as to any product covered by the report.



- 4.1 The shakes and shingles are treated, identified and installed in accordance with this report.
- 4.2 The shakes and shingles are pressure-treated by Chemco, Inc., in Ferndale, Washington, under a

quality control program with inspections by Fire Tech Services, Inc. (AA-641).

This report is subject to re-examination in two years.

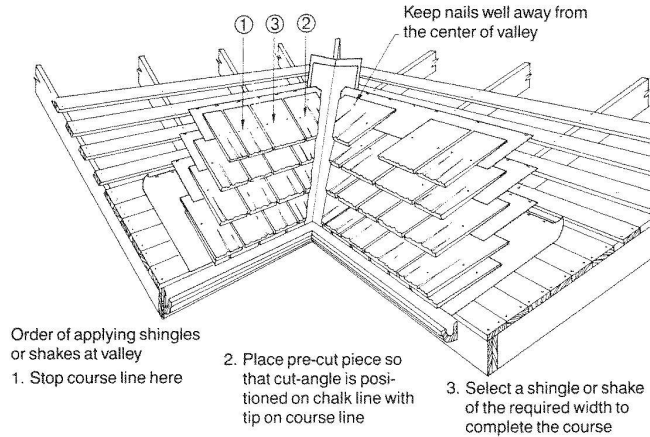
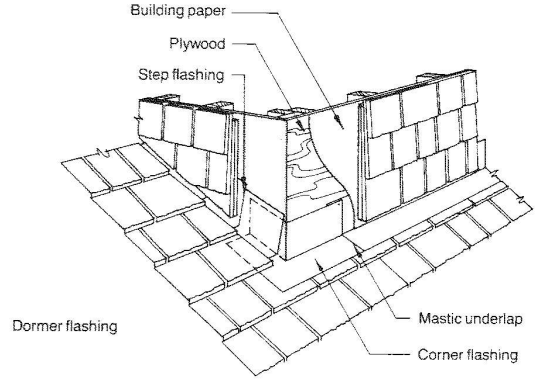
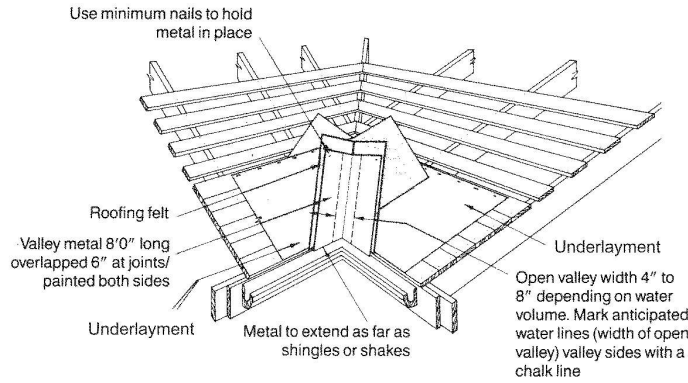

Order of applying shingles or shakes at valley

1. Stop course line here
2. Place pre-cut piece so that cut-angle is positioned on chalk line with tip on course line
3. Select a shingle or shake of the required width to complete the course

Flashing Details For Shingle and Shake Valleys

FIGURE 1—TYPICAL INSTALLATION DETAILS

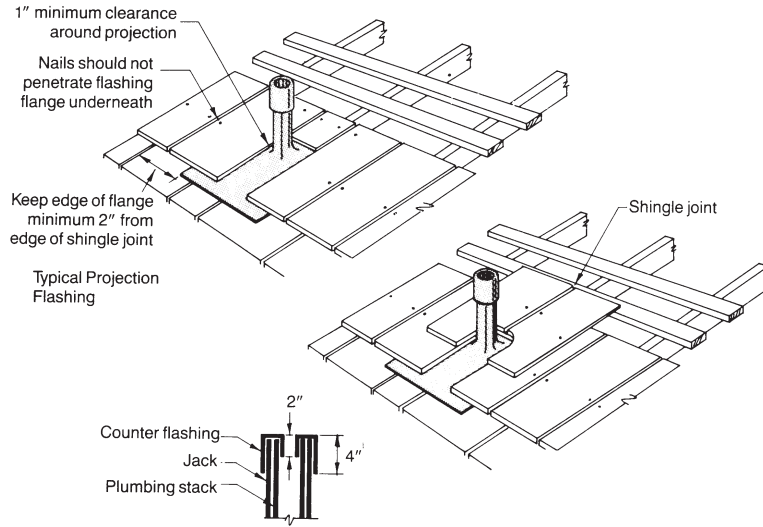

Flashing Details for Typical Roof Projections

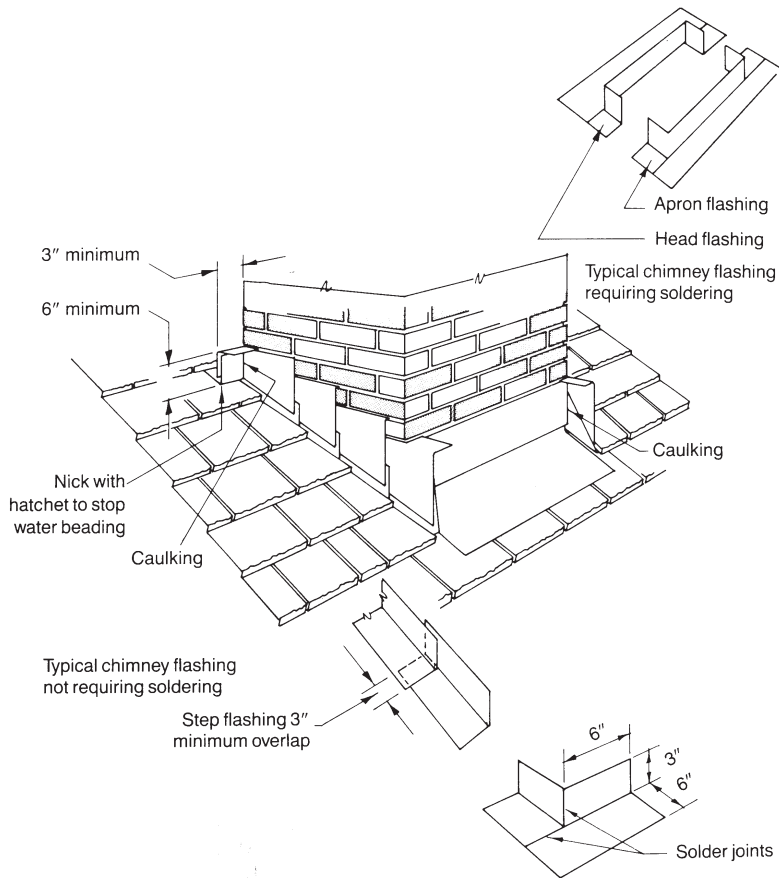

For SI: 1 inch = 25.4 mm, 1 foot = 304.8 mm.

FIGURE 1—TYPICAL INSTALLATION DETAILS—(Continued)



Class B Fire Retardant

N.E.R. NO. 215, ICBO ES ER 5404

Q.A. by FIRE TECH SERVICES, INC.
REPORT NO. AA-641
LISTING NO. 3500A

Must be applied in accordance with application instructions included with this roofing.



Class C Fire Retardant

ICBO ES ER 5404

Q.A. by FIRE TECH SERVICES, INC.
REPORT NO. AA-641
LISTING NO. 3500A

Must be applied in accordance with application instructions included with this roofing.

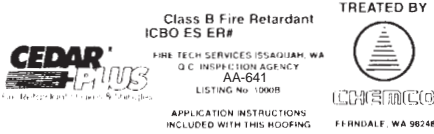

DURASHAKE® FT

Fire Retardant Treated Shakes & Shingles

Class C Fire Retardant - ICBO ES ER#
FIRE TECH SERVICES ISSAQUAH, WA

DURASHAKE IS A REGISTERED TRADEMARK OF AMERICAN WOOD PRESERVERS, INC. MISSION, BRITISH COLUMBIA V2V 4M4



DURASHAKE® FT

Fire Retardant Treated Shakes & Shingles

Class B Fire Retardant - ICBO ES ER#
FIRE TECH SERVICES ISSAQUAH, WA

DURASHAKE IS A REGISTERED TRADEMARK OF AMERICAN WOOD PRESERVERS, INC. MISSION, BRITISH COLUMBIA V2V 4M4

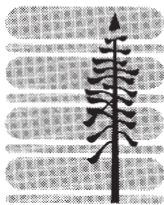
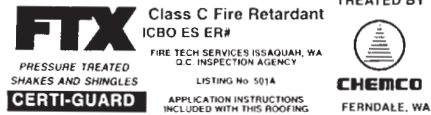

FST CLASS B FIRE RETARDANT SHAKES & SHINGLES

Treated by CHEMCO INC. FERNDALÉ WA 98248
EVALUATION REPORT NUMBER ER-5404

Q.A. by FIRE TECH SERVICES INC. REPORT NO. AA-641
LISTING NO. 3000.A Must be applied in accordance with application instructions included with this roofing.

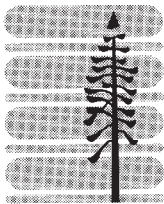

FST CLASS C FIRE RETARDANT SHAKES & SHINGLES

Treated by CHEMCO INC. FERNDALÉ WA 98248
EVALUATION REPORT NUMBER ER-5404

Q.A. by FIRE TECH SERVICES INC. REPORT NO. AA-641
LISTING NO. 3000.A Must be applied in accordance with application instructions included with this roofing.

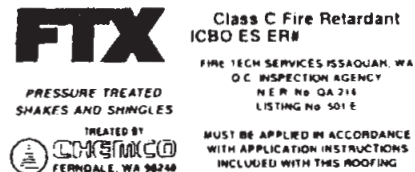

FIGURE 2—PRODUCT LABELS

FTX Class C Fire Retardant **STARTER-COURSE**
Treated by: Chemco ICBO Report No. ER 5404, Listing No. _____
Fire Tech Services Q.C. Inspection Agency, ICBO Report No. AA-641
Must be applied in accordance with application instructions included with this roofing
To be used as starter-course only with UBC 15-2 fire retardant roof systems

FTX Class B Fire Retardant **STARTER-COURSE**
Treated by: Chemco ICBO Report No. ER 5404, Listing No. _____
Fire Tech Services Q.C. Inspection Agency, ICBO Report No. AA-641
Must be applied in accordance with application instructions included with this roofing
To be used as starter-course only with UBC 15-2 fire retardant roof systems

FIGURE 3—TYPICAL STARTER COURSE LABELS