

DISPLAY THIS CARD ON PRINCIPAL FRONTAGE OF WORK



CITY OF PORTLAND

BUILDING PERMIT

This is to certify that Diversified Properties LLC

Located At 58 GERTRUDE AVE

Job ID: 2011-08-1835-SF

CBL: 402- D-003-001

2011-1401-AMEND

has permission to Build a new Single Family Residence.

provided that the person or persons, firm or corporation accepting this permit shall comply with all of the provisions of the Statues of Maine and of the Ordinances of the City of Portland regulating the construction, maintenance and use of the buildings and structures, and of the application on file in the department.

Notification of inspection and written permission procured before this building or part thereof is lathed or otherwise closed-in. 48 HOUR NOTICE IS REQUIRED.

A final inspection must be completed by owner before this building or part thereof is occupied. If a certificate of occupancy is required, it must be

Fire Prevention Officer

 01/18/2012
Code Enforcement Officer / Plan Reviewer

THIS CARD MUST BE POSTED ON THE STREET SIDE OF THE PROPERTY
PENALTY FOR REMOVING THIS CARD

Closed
↓

SCANNED

City of Portland, Maine - Building or Use Permit Application

389 Congress Street, 04101 Tel: (207) 874-8703, FAX: (207) 8716

Job No: 2011-08-1835-SF 2011-14101-AMEND	Date Applied: 12/19/2011	CBL: 402- D-003-001	
Location of Construction: 58 GERTRUDE AVE	Owner Name: DIVERSIFIED PROPERTIES INC	Owner Address: PO BOX 10127 PORTLAND, ME 04104	Phone: 207-773-4988
Business Name:	Contractor Name: Custom Built Homes	Contractor Address: 123 Christopher Rd., North Yamouth ME	Phone: (207) 650-6989
Lessee/Buyer's Name:	Phone:	Permit Type: BLDG - Building	Zone: R-3
Past Use: Single family home	Proposed Use: Same - Single family home – change permit 2011-08-1835 to build colonial instead of cape & relocate footprint 5' further back	Cost of Work: 20000.00	CEO District:
		Fire Dept: <input checked="" type="checkbox"/> Approved <i>same conditions as previous</i> <input type="checkbox"/> Denied <input type="checkbox"/> N/A	Inspection: Use Group: R3 Type: SB MVBEC Signature: <i>[Signature]</i>
Proposed Project Description: amend 2011-08-1835 to build colonial 32' x 24'		Pedestrian Activities District (P.A.D.)	

Permit Taken By:	Zoning Approval		
<p>1. This permit application does not preclude the Applicant(s) from meeting applicable State and Federal Rules.</p> <p>2. Building Permits do not include plumbing, septic or electrical work.</p> <p>3. Building permits are void if work is not started within six (6) months of the date of issuance. False informatin may invalidate a building permit and stop all work.</p>	Special Zone or Reviews	Zoning Appeal	Historic Preservation
	<input type="checkbox"/> Shoreland <input type="checkbox"/> Wetlands <input type="checkbox"/> Flood Zone <input type="checkbox"/> Subdivision <input type="checkbox"/> Site Plan <input type="checkbox"/> Maj <input type="checkbox"/> Min <input type="checkbox"/> MM Date: <i>OK w/conditions</i> <i>12/20/11 ABM</i>	<input type="checkbox"/> Variance <input type="checkbox"/> Miscellaneous <input type="checkbox"/> Conditional Use <input type="checkbox"/> Interpretation <input type="checkbox"/> Approved <input type="checkbox"/> Denied Date:	<input checked="" type="checkbox"/> Not in Dist or Landmark <input type="checkbox"/> Does not Require Review <input type="checkbox"/> Requires Review <input type="checkbox"/> Approved <input type="checkbox"/> Approved w/Conditions <input type="checkbox"/> Denied Date: <i>ABM</i>

CERTIFICATION

I hereby certify that I am the owner of record of the named property, or that the proposed work is authorized by the owner of record and that I have been authorized by the owner to make this application as his authorized agent and I agree to conform to all applicable laws of this jurisdiction. In addition, if a permit for work described in the appication is issued, I certify that the code official's authorized representative shall have the authority to enter all areas covered by such permit at any reasonable hour to enforce the provision of the code(s) applicable to such permit.

SIGNATURE OF APPLICANT	ADDRESS	DATE	PHONE
RESPONSIBLE PERSON IN CHARGE OF WORK, TITLE		DATE	PHONE

Memorandum
Department of Planning and Development
Planning Division



TO: Inspections Department

FROM: Philip DiPierro, Development Review Coordinator

DATE: March 28, 2012

RE: C. of O. for # 58 Gertrude Avenue, Wolf Single Family Home
(Id#2011-08-1835-SF) (CBL 402 D 003001)

After visiting the site, I have the following comments:

Site work incomplete:

1. Finish grading in accordance with the approved site plan, loaming, seeding, and mulching,
2. Planting of 2 street trees
3. Installation of paved apron at street/driveway entrance,

I anticipate this work can be completed by **June 30, 2012**.

At this time, **I recommend issuing a temporary Certificate of Occupancy.**

Cc: Tammy Munson, Inspection Services Manager
Barbara Barhydt, Development Review Services Manager
File: 1 Solution

BUILDING PERMIT INSPECTION PROCEDURES

Please call 874-8703 or 874-8693 (ONLY)

or email: buildinginspections@portlandmaine.gov

With the issuance of this permit, the owner, builder or their designee is required to provide adequate notice to the city of Portland Inspections Services for the following inspections. Appointments must be requested 48 to 72 hours in advance of the required inspection. The inspection date will need to be confirmed by this office.

- **Please read the conditions of approval that is attached to this permit!! Contact this office if you have any questions.**
 - **Permits expire in 6 months. If the project is not started or ceases for 6 months.**
 - **If the inspection requirements are not followed as stated below additional fees may be incurred due to the issuance of a "Stop Work Order" and subsequent release to continue.**
1. Footings/ Setbacks
 2. Foundation/ Backfill
 3. Close-In: (Electrical, Plumbing, Framing)
 4. Insulation prior to backfill
 5. Final Inspection/ Certificate of Occupancy

The project cannot move to the next phase prior to the required inspection and approval to continue, REGARDLESS OF THE NOTICE OF CIRCUMSTANCES.

IF THE PERMIT REQUIRES A CERTIFICATE OF OCCUPANCY, IT MUST BE PAID FOR AND ISSUED TO THE OWNER OR DESIGNEE BEFORE THE SPACE MAY BE OCCUPIED.



PORTLAND MAINE

Strengthening a Remarkable City, Building a Community for Life • www.portlandmaine.gov

Director of Planning and Urban Development

Job ID: 2011-08-1835-SF

Located At: GERTRUDE AVE

CBL: 402- D-003-001

Conditions of Approval:

Zoning

1. This permit is being approved on the basis of plans submitted on 12/19/11. This is an amendment to the original permit to change the house from a cape with a dormer to a colonial. The footprint has been relocated five feet further back on the property. Any deviations shall require a separate approval before starting that work.
2. As discussed during the review process, the property must be clearly identified prior to pouring concrete and compliance with the required setbacks must be established. Due to the proximity of the setbacks of the proposed addition, it may be required to be located by a surveyor.
3. This property shall remain a single family dwelling. Any change of use shall require a separate permit application for review and approval.
4. Separate permits shall be required for future decks, sheds, pools, and/or garages.

Fire

1. All construction shall comply with City Code Chapter 10.
2. **A sprinkler system shall be installed.**
3. A separate Suppression System Permit is required.
4. All smoke detectors and smoke alarms shall be photoelectric.
5. Hardwired Carbon Monoxide alarms with battery back up are required on each floor.

DRC

1. The Development Review Coordinator reserves the right to require additional lot grading or other drainage improvements as necessary due to field conditions.
2. The applicant shall have a licensed surveyor install, prior to the issuance of any Certificate of Occupancy, permanent monumentation/pins identifying property corners.
3. A street opening permit(s) is required for your site. Please contact Carol Merritt at 874-8300, ext. 8822. (Only excavators licensed by the City of Portland are eligible.)
4. All damage to sidewalk, curb, street, or public utilities shall be repaired to City of Portland standards prior to issuance of a certificate of occupancy.

Job ID: 2011-08-1835-SF Located At: GERTRUDE AVE CBL: 402- D-003-001

5. The Development Review Coordinator (874-8632) must be notified five (5) working days prior to date required for final site inspection. Please make allowances for completion of site plan requirements determined to be incomplete or defective during the inspection. This is essential as all site plan requirements must be completed and approved by the Development Review Coordinator prior to issuance of a Certificate of Occupancy. Please schedule any property closing with these requirements in mind.
6. Two (2) City of Portland approved species and size trees must be planted on your street frontage prior to issuance of a Certificate of Occupancy.
7. All Site work (final grading, landscaping, loam and seed) must be completed prior to issuance of a certificate of occupancy. A performance guarantee will be required to cover the cost of site work not completed due to seasonal conditions ie., finish grading, loaming, seeding, mulching, installation of street trees, etc. The performance guarantee must be reviewed, approved, and accepted by the Planning Authority prior to the release of a Temporary Certificate of Occupancy.
8. Trees that are designated to be saved are to be protected during excavation and construction. Tree protection fencing is to be installed around the tree canopy drip line prior to the start of any excavation. Tree protection measures are to be inspected and maintained daily.
9. Erosion and Sedimentation control shall be established and inspected by the Development Review Coordinator prior to soil disturbance, and shall be done in accordance with Best Management Practices, Maine Department of Environmental Protection Technical and Design Standards and Guidelines. All Erosion and Sedimentation control measures must be inspected and maintained daily.
10. The limits of allowable clearing shall be clearly marked with flagging or temporary fencing. Absolutely no clearing is to take place within, or encroach into the "do not disturb/no cut" zone. All conditions listed in the approved subdivision plan, as they relate to this lot shall be followed.
11. A sewer permit is required for your project. Please contact Carol Merritt at 874-8300, ext . 8822. The Wastewater and Drainage section of Public Services must be notified five (5) working days prior to sewer connection to schedule an inspector for your site.

Building

1. Separate permits are required for any electrical: plumbing, sprinkler, fire alarm, HVAC systems, commercial hood exhaust systems and fuel tanks. Separate plans may need to be submitted for approval as a part of this process.
2. Ventilation of this space is required per ASRAE 62.2 , 2007 edition; Building Envelope Energy Requirements must comply with MUBEC.
3. Window sills in locations more than 72 inches from finished grade shall be a minimum of 24 inches above the finished floor of the room, unless a window fall prevention devices is installed in accordance with section R612.3.
4. A code compliant emergency escape shall be provided in each bedroom. Window sills in locations more than 72 inches from finished grade shall be a minimum of 24 inches (no higher than 44 inches) above the finished floor of the room, or in compliance with Section R612.4.2 Operation for emergency escape.
5. A graspable handrail (34-38 inches in height) shall be provided on at least one side of each continuous run of treads or flight with four or more risers. Fall protection (36 inches) from exterior decks may be required if floor joist are at or above thirty (30) inches from grade.
6. Stairway headroom shall be not less than 6 feet 8 inches measured vertically from the sloped plane adjoining the tread nosing or from the floor surface of the landing or platform.
7. **Note: Submit specifications for Engineer Trusses prior to construction.**

ONE AND TWO FAMILY Soil type/Presumptive Load Value (Table R401.4.1)	PLAN REVIEW Submitted Plan	CHECKLIST Findings/Revisions/Dates
STRUCTURAL Footing Dimensions/Depth (Table R403.1 & R403.1(1), (Section R403.1 & R403.1.4.1)	10" x 16" Footings 2- #4 Rebar w/ 8" Thick Wall 24x24 for cally columns	Okay
Foundation Drainage, Fabric, Damp proofing (Section R405 & R406)	Damp & Pipe Damp proofing Stem	Okay
Ventilation/Access (Section R408.1 & R408.3) Crawls Space ONLY	N/A	Okay
Anchor Bolts/Straps, spacing (Section R403.1.6)	5/8" DIA Bolts 2 @ Corners 3'-0" o.c. 3 1/2" cally	Okay
Lally Column Type (Section R407) Girder & Header Spans (Table R 502.5(2)) Built-Up Wood Center Girder Dimension/Type	(3) 2x10" 5'-8" Max N	Okay
Sill/Band Joist Type & Dimensions First Floor Joist Species Dimensions and Spacing (Table R502.3.1(1) & Table R502.3.1(2))	2x6" P.T. 2x10" @ 16" o.c. 12'-0" Max	Okay Okay
Second Floor Joist Species Dimensions and Spacing (Table R502.3.1(1) & Table R502.3.1(2))	2x10" @ 16" o.c. 12'-0" Max	Okay
Attic or additional Floor Joist Species Dimensions and Spacing (Table R802.4(1) and R802.4(2))	Trusses 24" o.c w/ Bottom Chord	1) Need Specs.

Pitch, Span, Spacing & Dimension (Table R802.5.1(1) - R 802.5.1(8)) Roof Rafter; Framing & Connections (Section R802.3 & R802.3.1)	5' 12" @ 24" O.C. Trusses	
Sheathing: Floor, Wall and roof (Table R503.2.1.1(1))	Floor: 3/4" / Wall: 1/2" / Roof: 5/8"	Okay
Fastener Schedule (Table R602.3(1) & (2))	1" Per Gable	Okay
Private Garage (Section R309) Living Space? (Above or beside)	N/A	
Fire separation (Section R309.2) Opening Protection (Section R309.1)	N/A	
Emergency Escape and Rescue Openings (Section R310)	Shows on "A1 & A2"	Okay
Roof Covering (Chapter 9)	25% Asphalt	Okay
Safety Glazing (Section R308)	1" Tempered Glass in Bath	Okay
Attic Access (Section R807)	22 x 30" Slown	Okay
Chimney Clearances/Fire Blocking (Chap. 10)	N/A	
Header Schedule (Section 502.5(1) & (2))	"Short A2"	Okay
Energy Efficiency (N1101.2.1) R-Factors of Walls, Floors, Ceilings, Building Envelope, U-Factor Penetration	Floor: R-21 Ceilings: R-49 Walls: R-21 U-Factor: .35	

Applicant: Diversified Properties, Inc - Jim Wolf

Date: 7/25/11

Address: 58? Gertrude Ave. (Parcel A, Lot 1)

C-B-I: 402-D-003

permit # 10-0901 expired

CHECK-LIST AGAINST ZONING ORDINANCE

new permit 201-08-1130

Date - new

* amendment 12/20/11 change cype to colonial

Zone Location - R-3

Interior or corner lot -

* 2 story colonial

Proposed Use/Work - build new single family home - ~~2 stories colonial~~ - 24'x32'

~~open with dormer~~

Sewage Disposal - City

Lot Street Frontage - 50' min - 68' 3" min ✓

Front Yard - 25' min - ^{32'} 25' to steps scaled, ^{36'} 36' to house scaled (OK)

Rear Yard - 25' min - 34' to bulkhead scaled, ^{40'} 40' to house scaled (OK)

Side Yard - 2 stories - 14' min - 8' on left scaled - * can reduce to 8' need to hd of 25' (321) (OK)
- 2' on ~~right~~ right to steps

Projections -

Width of Lot - 65' min - 68' scaled.

Height - 35' max - ~~24' scaled~~ (OK) - * 24' scaled scaled @ lowest scale (OK)

Lot Area - 6500 sq ft min - 6765 sq ft min (OK)

Lot Coverage Impervious Surface - 35%

Area per Family - 6500 sq ft - ~~0.15~~

house 24' x 32' =
bulkhead 5' x 6' =
front entry 4 x 6 =
side entry 4 x 6 =

Off-street Parking - 2 spaces required - 2 stalls 15' x 10' (OK)

Loading Bays - N/A

Site Plan - 2010-0014 (minor/inter)

Shoreland Zoning/Stream Protection - N/A.

Flood Plains - parcel 7 - zone X

Job Name: Gertrude St.
Address:
City, State, Zip: Portland, ME
Customer: Rufus Deering
Code reports: ESR-1040

File Name: Daryl.BCC
Description: FB01
Specifier:
Designer: Chipper Roberts
Company: Boise Structural Solutions
Misc:

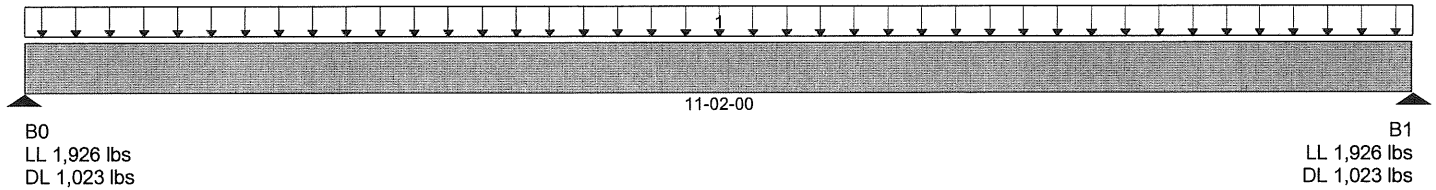

Total of Horizontal Design Spans = 11-02-00

				Live	Dead	Snow	Wind	Roof Live	Trib.
Tag	Description	Load Type	Ref. Start End	100%	90%	115%	133%	125%	
1	Standard Load	Unf. Area (psf)	L 00-00-00 11-02-00	30	15				11-06-00

Controls Summary	Value	% Allowable	Duration	Case	Span
Pos. Moment	8,233 ft-lbs	65.5%	100%	1	1 - Internal
End Shear	2,592 lbs	35.8%	100%	1	1 - Left
Total Load Defl.	L/242 (0.554")	99.3%		1	1
Live Load Defl.	L/370 (0.362")	97.2%		1	1
Max Defl.	0.554"	55.4%		1	1
Span / Depth	18.5	n/a			1

Disclosure

Completeness and accuracy of input must be verified by anyone who would rely on output as evidence of suitability for particular application. Output here based on building code-accepted design properties and analysis methods. Installation of BOISE engineered wood products must be in accordance with current Installation Guide and applicable building codes. To obtain Installation Guide or ask questions, please call (800)232-0788 before installation.

Notes

Design meets Code minimum (L/240) Total load deflection criteria.
Design meets Code minimum (L/360) Live load deflection criteria.
Design meets arbitrary (1") Maximum load deflection criteria.
Minimum bearing length for B0 is 1-1/2".
Minimum bearing length for B1 is 1-1/2".
Entered/Displayed Horizontal Span Length(s) = Clear Span + 1/2 min. end bearing + 1/2 intermediate bearing

BC CALC®, BC FRAMER®, AJSTM, ALLJOIST®, BC RIM BOARD™, BCI®, BOISE GLULAM™, SIMPLE FRAMING SYSTEM®, VERSA-LAM®, VERSA-RIM PLUS®, VERSA-RIM®, VERSA-STRAND®, VERSA-STUD® are trademarks of Boise Cascade Wood Products L.L.C.

Connection Diagram

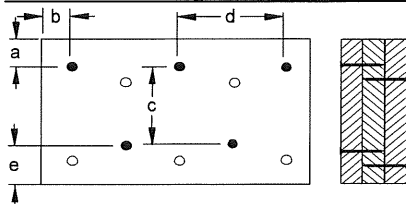

a minimum = 2" c = 2-1/4"
b minimum = 3" d = 24"
e minimum = 3"

Nailing schedule applies to both sides of the member.
Member has no side loads.
Connectors are: 16d Sinker Nails

Job	Truss	Truss Type	Qty	Ply	STANDARDS IRC 2009	17608499
STANDARDS_IRC_2009	S26C	STANDARD	1	1		

Mainly Trusses, Inc., Fairfield, ME

7.250 e Mar 23 2011 MiTek Industries, Inc. Tue Mar 29 07:43:29 2011 Page 1
ID:ktRAUbx3WC_8nRHUFFzjo8yKHBz-2g_q0EPbXaZ3P1qb7SzCOFTbGQISOJhSw54A11zW8MC

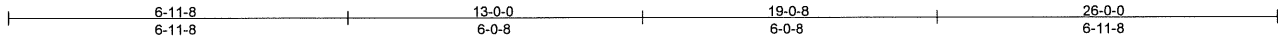

Scale = 1:44.3

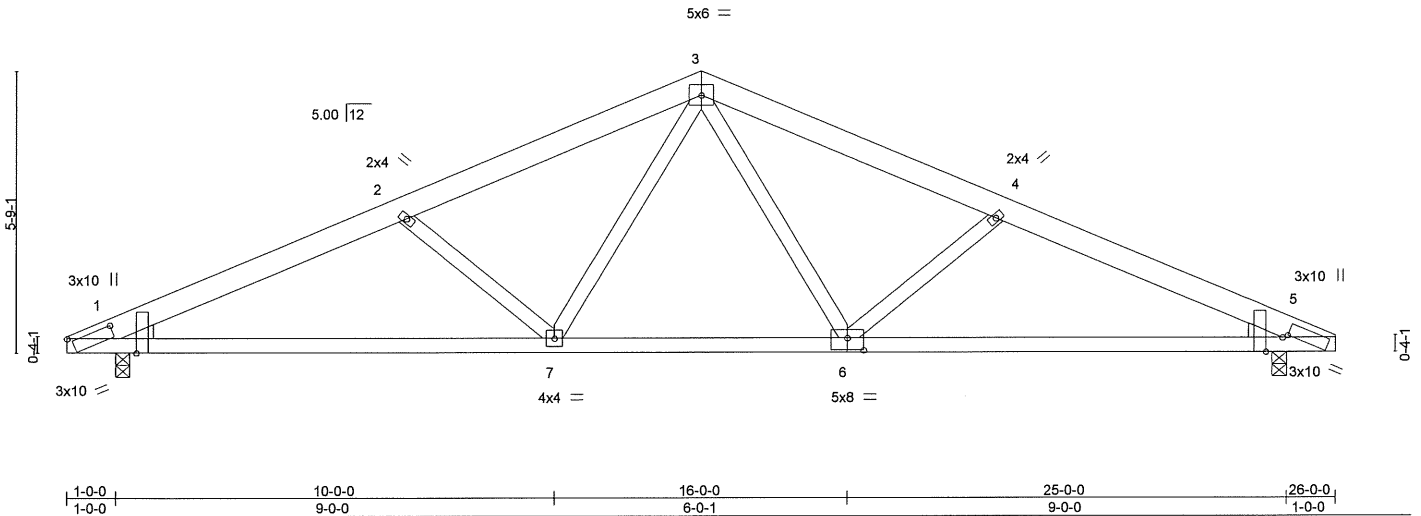

Plate Offsets (X,Y): [1:0-3-8,Edge], [1:0-11-0,0-1-0], [5:0-3-8,Edge], [5:0-1-0,0-1-0], [6:0-4-0,0-3-0]

LOADING (psf)	SPACING	CSI	DEFL	PLATES	GRIP
TCLL 61.6 (Ground Snow=80.0)	2-0-0 Plates Increase 1.15 Lumber Increase 1.15	TC 0.89 BC 0.78 WB 0.34 (Matrix)	in (loc) l/def L/d Vert(LL) -0.21 5-6 >999 240 Vert(TL) -0.54 5-6 >544 180 Horz(TL) 0.13 5 n/a n/a	MT20	197/144
TCDL 7.0	Rep Stress Incr YES				
BCLL 0.0	Code IRC2009/TPI2007				
BCDL 10.0				Weight: 104 lb	FT = 15%

LUMBER

TOP CHORD 2 X 6 SPF No.2
 BOT CHORD 2 X 4 SPF 1650F 1.5E
 WEBS 2 X 4 SPF No.2
 WEDGE
 Left: 2 X 4 SPF No.2, Right: 2 X 4 SPF No.2

BRACING

TOP CHORD Structural wood sheathing directly applied or 3-1-3 oc purlins.
 BOT CHORD Rigid ceiling directly applied or 9-0-15 oc bracing.

MiTek recommends that Stabilizers and required cross bracing be installed during truss erection, in accordance with Stabilizer Installation guide.

REACTIONS

(lb/size) 5=1928/0-3-8 (min. 0-3-0), 1=1928/0-3-8 (min. 0-3-0)
 Max Horz 1=84(LC 7)
 Max Uplift 5=323(LC 8), 1=323(LC 7)

FORCES (lb) - Max. Comp./Max. Ten. - All forces 250 (lb) or less except when shown.

TOP CHORD 1-2=-3740/650, 2-3=-3056/517, 3-4=-3056/517, 4-5=-3740/651
 BOT CHORD 1-7=-602/3307, 6-7=-262/2256, 5-6=-519/3307
 WEBS 2-7=-1065/349, 3-7=-153/974, 3-6=-153/974, 4-6=-1066/350

NOTES

- 1) Wind: ASCE 7-05; 100mph; TCDL=4.2psf; BCDL=6.0psf; h=25ft; Cat. II; Exp C; enclosed; MWFRS (low-rise) gable end zone; cantilever left and right exposed; end vertical left and right exposed; Lumber DOL=1.60 plate grip DOL=1.60
- 2) TCLL: ASCE 7-05; Pg=80.0 psf (ground snow); Ps=61.6 psf (roof snow); Category II; Exp C; Partially Exp.; Ct=1.1
- 3) Roof design snow load has been reduced to account for slope.
- 4) Unbalanced snow loads have been considered for this design.
- 5) This truss has been designed for a 10.0 psf bottom chord live load nonconcurrent with any other live loads.
- 6) Provide mechanical connection (by others) of truss to bearing plate capable of withstanding 100 lb uplift at joint(s) except (jt=lb) 5=323, 1=323.
- 7) This truss is designed in accordance with the 2009 International Residential Code sections R502.11.1 and R802.10.2 and referenced standard ANSI/TPI 1.
- 8) "Semi-rigid pitchbreaks including heels" Member end fixity model was used in the analysis and design of this truss.

LOAD CASE(S) Standard

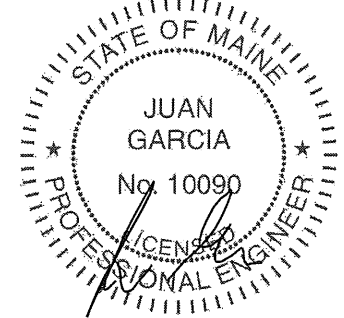
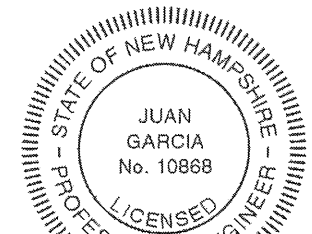

March 29, 2011



State of Maine
Department of Public Safety



Fire Sprinkler System Permit

9918

58 Gertrude ave

Located at: 58 Gertrude Avenue

In the Town of: Portland

Occupancy/Use: NFPA 13D

Type of System:

Permission is hereby given to: *Tin Davis Plumbing & Heating Inc.*
P.O. Box 255
LYMAN, ME. 04002

Contractor License # *831*

RECEIVED

MAR 27 2012

Dept. of Building Inspections
City of Portland Maine

to begin installation according to plans submittal approved by the Office of State Fire Marshal.
The submittal is filed under log # **2121092**, and no departure from the application submittal shall be made without prior approval in writing. This permit is issued under the provisions of Title 32, Chapter 20, Section 12004-I. Nothing herein shall excuse the holder of this permit from failure to comply with local ordinances, zoning laws, or other pertinent legal restrictions. This permit shall be displayed at the construction site or be made readily available.

This permit was issued on **3/19/2012** for a fee paid of **\$75.00**

This permit will expire at midnight on Saturday, September 15, 2012

The expiration date applies only if the installation has not begun by that date and no permission has been granted to extend the date. Once installation begins, then the permit is valid for however long it takes to complete the installation, assuming that the work is fairly continuous.

John E. Morris
Commissioner

The type of Fire Department Connection and its location is to be according to the Local Fire Department

Within 30 days of the completion of a new fire sprinkler system or an addition to an existing fire sprinkler system, a fire sprinkler system contractor shall provide to the Office of State Fire Marshal a copy of this permit signed and dated by the certified Responsible Managing Supervisor representing that the fire sprinkler system has been installed according to specifications of the approved plan to the best of the supervisor's knowledge, information, and belief. This requirement is part of the sprinkler law, and neglect of this duty is grounds to not renew the contractor's license to do work in the State of Maine. All renewed sprinkler licenses are good for two years and expire on a June 30th.

Job completed, tested, and verified by date of 3/24/12

RMS for this job: Killeen Thomas J.

RMS Signature:



Water-Based Fire Suppression System Permit

If you or the property owner owes real estate or property taxes or user charges on any property within the city, payment arrangements must be made before permits of any kind are accepted.

Installation address: 58 GERTVOOR AVENUE CBL: _____

Exact location: (within structure) ON ALL FLOORS INCLUDING BASEMENT

Type of occupancy(s) (NFPA & ICC): NFPA 130

Building owner: DIVERSIFIED PROPERTIES

Managing Supervisor (RMS): THOMAS KILHEEN License No: 351

Supervisor phone: 007-752-4102 E-mail: N/A

Installing contractor: TIM DAVIS PLUMBING & HEATING, INC. License No: # 831

Contractor phone: 1-207-324-5237 E-mail: TDPHINC@jaboo.com

The suppression work to be done will be: New: Renovation: Addition to existing system:

This is an amendment to an existing permit: Yes: NO Permit no: # 9918

NFPA Standard this system is designed to: 130 Edition: 2010

*Non-NFPA systems are not approved for use within the City of Portland.

Download a new copy of this document from www.portlandmaine.gov/fire for every submittal. Attach all working documents and complete approved submittals as may be required by the State Fire Marshal's Office on electronic PDF's in addition to full sized plans.

Contractor shall verify location and type of all FDCs shall be approved in writing by the Fire Prevention Bureau.

COST OF WORK: _____
PERMIT FEE: _____
 (\$10 PER \$1,000 + \$30 FOR THE FIRST \$1,000)

RECEIVED
 MAR 27 2012
 Dept. of Building Inspections
 City of Portland Maine

Submit all information to the Building Inspections Department, 389 Congress Street, Room 315, Portland, Maine 04101.

Prior to acceptance of any fire protection system, a complete commissioning and acceptance test must be coordinated with all fire system contractors and the Fire Department, and proper documentation of such test(s) provided.

All installation(s) must comply with NFPA and the Fire Department Technical Standard(s).

Applicant signature: [Signature] Date: 3/23/12

DISPLAY THIS CARD ON PRINCIPAL FRONTAGE OF WORK



CITY OF PORTLAND

BUILDING PERMIT

This is to certify that DIVERSIFIED PROPERTIES INC Located At 58 GERTRUDE AVE

Job ID: 2012-03-3468-ALTR

CBL: 402- D-003-001

2011-08-1835

has permission to Amendment to Building Permit # 2011-08-1835 (Single Family Residence).
provided that the person or persons, firm or corporation accepting this permit shall comply with all of the provisions of the Statues of Maine and of the Ordinances of the City of Portland regulating the construction, maintenance and use of the buildings and structures, and of the application on file in the department.

Notification of inspection and written permission procured before this building or part thereof is lathed or otherwise closed-in. 48 HOUR NOTICE IS REQUIRED.

A final inspection must be completed by owner before this building or part thereof is occupied. If a certificate of occupancy is required, it must be

Fire Prevention Officer

Code Enforcement Officer / Plan Reviewer

03/26/2012

THIS CARD MUST BE POSTED ON THE STREET SIDE OF THE PROPERTY
PENALTY FOR REMOVING THIS CARD

SCANNED

BUILDING PERMIT INSPECTION PROCEDURES

Please call 874-8703 or 874-8693 (ONLY)

or email: buildinginspections@portlandmaine.gov

With the issuance of this permit, the owner, builder or their designee is required to provide adequate notice to the city of Portland Inspections Services for the following inspections. Appointments must be requested 48 to 72 hours in advance of the required inspection. The inspection date will need to be confirmed by this office.

- **Please read the conditions of approval that is attached to this permit!! Contact this office if you have any questions.**
- **Permits expire in 6 months. If the project is not started or ceases for 6 months.**
- **If the inspection requirements are not followed as stated below additional fees may be incurred due to the issuance of a "Stop Work Order" and subsequent release to continue.**

1. Follow inspection requirements under building permit # 2011-08-1835.

The project cannot move to the next phase prior to the required inspection and approval to continue, REGARDLESS OF THE NOTICE OF CIRCUMSTANCES.

IF THE PERMIT REQUIRES A CERTIFICATE OF OCCUPANCY, IT MUST BE PAID FOR AND ISSUED TO THE OWNER OR DESIGNEE BEFORE THE SPACE MAY BE OCCUPIED.



PORTLAND MAINE

Strengthening a Remarkable City, Building a Community for Life • www.portlandmaine.gov

Acting Director of Planning and Urban Development
Gregory Mitchell

Job ID: 2012-03-3468-ALTR

Located At: 58 GERTRUDE AVE

CBL: 402- D-003-001

Conditions of Approval:

Zoning

1. This permit is being approved on the basis of plans submitted. Any deviations shall require a separate approval before starting that work.
2. This property shall remain a single family dwelling. Any change of use shall require a separate permit application for review and approval.
3. This permit is being approved on the basis that the footprint and location of the structure has not changed from the last submitted site plan.

Fire

1. All construction shall comply with City Code Chapter 10.
2. All smoke detectors and smoke alarms shall be photoelectric.
3. Hardwired Carbon Monoxide alarms with battery back up are required on each floor.

Building

1. All conditions under Building Permit # 2011-08-1835-SF apply.
2. Submit specifications for Engineered Beams and Trusses, fastening schedule and point loads shall comply with MUBEC and the Manufacturers' recommendations.
3. R308.1 Identification. Except as indicated in Section R308.1.1 each pane of glazing installed in hazardous locations as defined in Section R308.4 shall be provided with a manufacturer's designation.

City of Portland, Maine - Building or Use Permit Application

389 Congress Street, 04101 Tel: (207) 874-8703, FAX: (207) 8716

Job No: 2012-03-3468-ALTR	Date Applied: 3/9/2012	CBL: 402- D-003-001	
Location of Construction: 58 GERTRUDE AVE	Owner Name: DIVERSIFIED PROPERTIES INC	Owner Address: PO BOX 10127 PORTLAND, ME 04103	Phone: 207-773-4988
Business Name:	Contractor Name: Custom Built Homes	Contractor Address: 123 Christopher RD North Yarmouth ME 04097	Phone: (207) 650-6989
Lessee/Buyer's Name:	Phone:	Permit Type: BLDG - Building	Zone: R-3
Past Use: New Single family home – permit #2011-08-1835	Proposed Use: Same – new single family home – Interior changes to 1st floor layout, add window 2 nd floor, add beam in basement, change bulkhead to doghouse	Cost of Work: 1000.00	CEO District:
		Fire Dept: <input checked="" type="checkbox"/> Approved w/ con details <input type="checkbox"/> Denied <input type="checkbox"/> N/A Signature: <i>Capt. Prime 3/15/12</i>	Inspection: Use Group: R3 Type: SB MUBEC Signature: <i>AR</i>
Proposed Project Description: Amend building plans - permit #2011-08-1835		Pedestrian Activities District (P.A.D.)	

Permit Taken By:	Zoning Approval		
<p>1. This permit application does not preclude the Applicant(s) from meeting applicable State and Federal Rules.</p> <p>2. Building Permits do not include plumbing, septic or electrical work.</p> <p>3. Building permits are void if work is not started within six (6) months of the date of issuance. False informatin may invalidate a building permit and stop all work.</p>	Special Zone or Reviews <input type="checkbox"/> Shoreland <input type="checkbox"/> Wetlands <i>has permit</i> <input type="checkbox"/> Flood Zone <i>is remaining</i> <input type="checkbox"/> Subdivision <i>the same</i> <input type="checkbox"/> Site Plan <input type="checkbox"/> Maj <input type="checkbox"/> Min <input type="checkbox"/> MM Date: <i>Ok w/ conditions 3/12/12 ABM</i>	Zoning Appeal <input type="checkbox"/> Variance <input type="checkbox"/> Miscellaneous <input type="checkbox"/> Conditional Use <input type="checkbox"/> Interpretation <input type="checkbox"/> Approved <input type="checkbox"/> Denied Date:	Historic Preservation <input checked="" type="checkbox"/> Not in Dist or Landmark <input type="checkbox"/> Does not Require Review <input type="checkbox"/> Requires Review <input type="checkbox"/> Approved <input type="checkbox"/> Approved w/Conditions <input type="checkbox"/> Denied Date: <i>ABM</i>
	CERTIFICATION		

I hereby certify that I am the owner of record of the named property, or that the proposed work is authorized by the owner of record and that I have been authorized by the owner to make this application as his authorized agent and I agree to conform to all applicable laws of this jurisdiction. In addition, if a permit for work described in the appication is issued, I certify that the code official's authorized representative shall have the authority to enter all areas covered by such permit at any reasonable hour to enforce the provision of the code(s) applicable to such permit.

SIGNATURE OF APPLICANT	ADDRESS	DATE	PHONE
RESPONSIBLE PERSON IN CHARGE OF WORK, TITLE		DATE	PHONE

Project Description/changes

Basement-Adding a Beam

First Floor-Beam between eating and living area, location of bath moved, removed bath window, laundry added, sliding door to kitchen

Second Floor-added hall window

Outside- added dog house entrance to basement

Chris/Ben - this is the
amendment to a single
family home & that was
originally submitted before they
had to be sprinkled.
Am

2.3

Entered 3/9/12 (B)



General Building Permit Application

2012-03-3468-AMB

If you or the property owner owes real estate or personal property taxes or user charges on any property within the City, payment arrangements must be made before permits of any kind are accepted.

Location/Address of Construction: <u>58 Gertrude Ave, Port.</u>		
Total Square Footage of Proposed Structure/Area <u>1536</u>	Square Footage of Lot <u>6804.40</u>	Number of Stories <u>2</u>
Tax Assessor's Chart, Block & Lot Chart# Block# Lot# <u>402</u> <u>D</u> <u>3-4</u>	Applicant: (must be owner, lessee or buyer) Name <u>Diversified Properties</u> Address <u>POB 10127</u> City, State & Zip <u>Portland, ME</u>	Telephone: <u>723-4988</u>
Lessee/DBA RECEIVED MAR 09 2012 Dept. of Building Inspections City of Portland Maine	Owner: (if different from applicant) Name Address City, State & Zip	Cost of Work: \$ <u>350.00</u> C of O Fee: \$ _____ Historic Review: \$ _____ Planning Amin.: \$ _____ Total Fee: \$ <u>30.00</u>
Current legal use (i.e. single family) <u>Vacant</u> Number of Residential Units _____ If vacant, what was the previous use? <u>Vacant</u> Proposed Specific use: <u>Single family home</u> Is property part of a subdivision? _____ If yes, please name _____ Project description: <u>see attached - changes to original House Plans</u>		
Contractor's name: <u>Custom Built Homes</u> Email: _____ Address: <u>123 Christopher</u> City, State & Zip <u>N. Yarmouth, ME</u> Telephone: _____ Who should we contact when the permit is ready: <u>Ken Gervais</u> Telephone: <u>650 6989</u> Mailing address: <u>POB 10127 Portland, ME</u>		

Please submit all of the information outlined on the applicable checklist. Failure to do so will result in the automatic denial of your permit.

In order to be sure the City fully understands the full scope of the project, the Planning and Development Department may request additional information prior to the issuance of a permit. For further information or to download copies of this form and other applications visit the Inspections Division on-line at www.portlandmaine.gov, or stop by the Inspections Division office, room 315 City Hall or call 874-8703.

and I hereby certify that I am the Owner of record of the named property, or that the owner of record authorizes the proposed work and that I have been authorized by the owner to make this application as his/her authorized agent. I agree to conform to all applicable laws of this jurisdiction. In addition, if a permit for work described in this application is issued, I certify that the Code Official's authorized representative shall have the authority to enter all areas covered by this permit at any reasonable hour to enforce the provisions of the codes applicable to this permit.

Signature: [Signature] Date: 3-5-2012

This is not a permit; you may not commence ANY work until the permit is issued

Applicant: Diversified Properties Inc.

Date: 3/12/12

Address: 58 Gertrude Ave

C-B-L: 402-D-003

permit # 2012-03-3468

CHECK-LIST AGAINST ZONING ORDINANCE

Date - amend permit # 2011-08-1835

Zone Location - R-3

Interior or corner lot -

Proposed Use/Work - Change bulkhead to doghouse - 5'x6', add beam in basement, minor changes to 1st & 2nd floor

Sevage Disposal -

Lot Street Frontage -

N/A

Front Yard -

Rear Yard - 25' min - 39' L bulkhead (OK)

Side Yard - 14' min - 32' on right side (OK)

Projections -

Width of Lot -

N/A

Height -

Lot Area -

Lot Coverage/ Impervious Surface -

Area per Family -

N/A

Off-street Parking -

Loading Bays -

Site Plan -

Shoreland Zoning/ Stream Protection -

Flood Plains -



PORTLAND MAINE

Strengthening a Remarkable City, Building a Community for Life • www.portlandmaine.gov

Receipts Details:

Tender Information: Check , Check Number: 4671

Tender Amount: 30.00

Receipt Header:

Cashier Id: bsaucier

Receipt Date: 3/9/2012

Receipt Number: 41586

Receipt Details:

Referance ID:	5520	Fee Type:	BP-Constr
Receipt Number:	0	Payment Date:	
Transaction Amount:	30.00	Charge Amount:	30.00
Job ID: Job ID: 2012-03-3468-ALTR - Alterations to existing home			
Additional Comments: 58 Gertrude			

Thank You for your Payment!

DISPLAY THIS CARD ON PRINCIPAL FRONTAGE OF WORK



CITY OF PORTLAND

BUILDING PERMIT

This is to certify that DIVERSIFIED PROPERTIES LLC Located At 58 GERTRUDE AVE

Job ID: 2011-08-1835-SF

CBL: 402- D-003-001

2012-42122 HVAC

has permission to Install an HVAC system (Single Family Residence).

provided that the person or persons, firm or corporation accepting this permit shall comply with all of the provisions of the Statues of Maine and of the Ordinances of the City of Portland regulating the construction, maintenance and use of the buildings and structures, and of the application on file in the department.

Notification of inspection and written permission procured before this building or part thereof is lathed or otherwise closed-in. 48 HOUR NOTICE IS REQUIRED.

A final inspection must be completed by owner before this building or part thereof is occupied. If a certificate of occupancy is required, it must be

04/09/2012

Fire Prevention Officer

Code Enforcement Officer / Plan Reviewer

THIS CARD MUST BE POSTED ON THE STREET SIDE OF THE PROPERTY
PENALTY FOR REMOVING THIS CARD

SCANNED

BUILDING PERMIT INSPECTION PROCEDURES

Please call 874-8703 or 874-8693 (ONLY)

or email: buildinginspections@portlandmaine.gov

With the issuance of this permit, the owner, builder or their designee is required to provide adequate notice to the city of Portland Inspections Services for the following inspections. Appointments must be requested 48 to 72 hours in advance of the required inspection. The inspection date will need to be confirmed by this office.

- **Please read the conditions of approval that is attached to this permit!! Contact this office if you have any questions.**
- **Permits expire in 6 months. If the project is not started or ceases for 6 months.**
- **If the inspection requirements are not followed as stated below additional fees may be incurred due to the issuance of a "Stop Work Order" and subsequent release to continue.**

1. Close-In: (Electrical, Plumbing, Framing)
2. Final Inspection

The project cannot move to the next phase prior to the required inspection and approval to continue, REGARDLESS OF THE NOTICE OF CIRCUMSTANCES.

IF THE PERMIT REQUIRES A CERTIFICATE OF OCCUPANCY, IT MUST BE PAID FOR AND ISSUED TO THE OWNER OR DESIGNEE BEFORE THE SPACE MAY BE OCCUPIED.



PORTLAND MAINE

Strengthening a Remarkable City, Building a Community for Life • www.portlandmaine.gov

Acting Director of Planning and Urban Development
Gregory Mitchell

Job ID: 2011-08-1835-SF

Located At: GERTRUDE AVE

CBL: 402- D-003-001

Conditions of Approval:



Building

1. The installation must comply with UL, the Manufacturers' Listing, and State of Maine Gas Regulations.
2. Separate permits are required for any electrical: plumbing, sprinkler, fire alarm, HVAC systems, commercial hood exhaust systems and fuel tanks. Separate plans may need to be submitted for approval as a part of this process.
3. Maintain proper setback(s) from property lines/buildings and proper clearances from vertical openings when direct venting
4. A Carbon Monoxide (CO) alarm shall be installed in each area within or giving access to bedrooms. That detection must be powered by the electrical service (plug-in or hardwired) in the building and battery.
5. M1804.2.5 Direct vent terminations. Vent terminals for direct-vent appliances shall be installed in accordance with the manufacturer's installation instructions.

City of Portland, Maine - Building or Use Permit Application

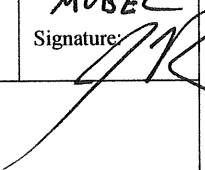
389 Congress Street, 04101 Tel: (207) 874-8703, FAX: (207) 8716

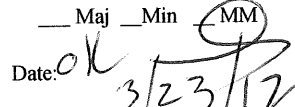
Job No: 2011-08-1835-SF 2012-42122 HVAC	Date Applied: 3/21/2012	CBL: 402- D-003-001	
Location of Construction: 58 GERTRUDE AVE	Owner Name: DIVERSIFIED PROPERTIES INC	Owner Address: PO BOX 10127, PORTLAND, ME 04104	Phone:
Business Name:	Contractor Name: Tim Davis Plumbing & Heating Inc.	Contractor Address: P O BOX 255, Lyman, ME 04002	Phone: (207) 324-5237
Lessee/Buyer's Name:	Phone:	Permit Type: HVAC	Zone: R-3
Past Use: Single Family Dwelling (under construction)	Proposed Use: Same: Single Family Dwelling - to install Crown Maui heating system	Cost of Work: \$4,000.00	CEO District:
		Fire Dept: <input type="checkbox"/> Approved <input type="checkbox"/> Denied <input checked="" type="checkbox"/> N/A	Inspection: Use Group: R3 Type: SB MUBEC Signature: 
Proposed Project Description: HVAC		Pedestrian Activities District (P.A.D.)	
Permit Taken By: Brad		Zoning Approval	

<p>1. This permit application does not preclude the Applicant(s) from meeting applicable State and Federal Rules.</p> <p>2. Building Permits do not include plumbing, septic or electrical work.</p> <p>3. Building permits are void if work is not started within six (6) months of the date of issuance. False informatin may invalidate a building permit and stop all work.</p>	<p>Special Zone or Reviews</p> <p><input type="checkbox"/> Shoreland</p> <p><input type="checkbox"/> Wetlands</p> <p><input type="checkbox"/> Flood Zone</p> <p><input type="checkbox"/> Subdivision</p> <p><input type="checkbox"/> Site Plan</p> <p>___ Maj ___ Min (MM)</p> <p>Date:  3/23/12</p>	<p>Zoning Appeal</p> <p><input type="checkbox"/> Variance</p> <p><input type="checkbox"/> Miscellaneous</p> <p><input type="checkbox"/> Conditional Use</p> <p><input type="checkbox"/> Interpretation</p> <p><input type="checkbox"/> Approved</p> <p><input type="checkbox"/> Denied</p> <p>Date:</p>	<p>Historic Preservation</p> <p><input checked="" type="checkbox"/> Not in Dist or Landmark</p> <p><input type="checkbox"/> Does not Require Review</p> <p><input type="checkbox"/> Requires Review</p> <p><input type="checkbox"/> Approved</p> <p><input type="checkbox"/> Approved w/Conditions</p> <p><input type="checkbox"/> Denied</p> <p>Date: </p>
	CERTIFICATION		

I hereby certify that I am the owner of record of the named property, or that the proposed work is authorized by the owner of record and that I have been authorized by the owner to make this application as his authorized agent and I agree to conform to all applicable laws of this jurisdiction. In addition, if a permit for work described in the application is issued, I certify that the code official's authorized representative shall have the authority to enter all areas covered by such permit at any reasonable hour to enforce the provision of the code(s) applicable to such permit.

SIGNATURE OF APPLICANT	ADDRESS	DATE	PHONE
RESPONSIBLE PERSON IN CHARGE OF WORK, TITLE		DATE	PHONE



FILL IN AND SIGN WITH INK

Entered 3/23/12

APPLICATION FOR PERMIT HEATING OR POWER EQUIPMENT

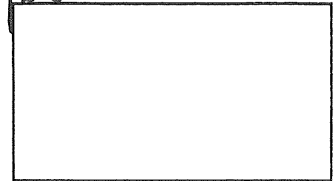

JOB ID: 2011-08-1835 SF

R-3

To the INSPECTOR OF BUILDINGS, PORTLAND, ME.

2012-42122

The undersigned hereby applies for a permit to install the following heating, cooking or power equipment in accordance with the Laws of Maine, the Building Code of the City of Portland, and the following specifications:

Location / CBL 58 Gertrude Ave 402-D-3 Use of Building Residential Date 3/23/12

Name and address of owner of appliance Diversified Properties INC PO Box 10129
Portland ME 04104

Installer's name and address Tim Davis Plumbing & Heating INC.
P.O. Box 255 Lyman, ME 04002 Telephone 207-324-5237

Location of appliance:

- Basement
- Attic
- Floor
- Roof

Type of Fuel:

- Gas
- Oil
- Solid

Appliance Name: Crown MA11

U.L. Approved Yes No

Will appliance be installed in accordance with the manufacture's installation instructions? Yes No

IF NO Explain: _____

RECEIVED
MAR 23 2012
Dept. of Building Inspections
City of Portland Maine

The Type of License of Installer:

- Master Plumber # _____
- Solid Fuel # _____
- Oil # _____
- Gas # PWT 4629
- Other _____

9/30/13

Type of Chimney:

Masonry Lined
Factory built _____

Metal
Factory Built U.L. Listing # _____

Direct Vent
Type PVC UL# _____

Type of Fuel Tank

- Oil
- Gas

Size of Tank 100 Gall

Number of Tanks 1

Distance from Tank to Center of Flame 30' feet.

Cost of Work: \$ 3,500.00 4000

Permit Fee: \$ 60

Approved

Approved with Conditions

Fire: _____
Ele.: _____
Bldg.: _____

See attached letter or requirement

Inspector's Signature _____ Date Approved _____

Signature of Installer _____



PORTLAND MAINE

Strengthening a Remarkable City, Building a Community for Life • www.portlandmaine.gov

Receipts Details:

Tender Information: Check , Check Number: 4603

Tender Amount: 60.00

Receipt Header:

Cashier Id: bsaucier

Receipt Date: 3/23/2012

Receipt Number: 42123

Receipt Details:

Referance ID:	5769	Fee Type:	BP-HVAC
Receipt Number:	0	Payment Date:	
Transaction Amount:	60.00	Charge Amount:	60.00
Job ID: Job ID: 2011-08-1835-SF - New Single Family renew permit #100901 UI			
Additional Comments: 58 Gertrude; HVAC			

Thank You for your Payment!

CROWN Boiler Co.

DESIGNED TO LEAD

MWC Series

Mid Efficiency Gas-Fired Hot Water
Direct Vent Condensing Boilers

INSTALLATION INSTRUCTIONS

These instructions must be affixed on or adjacent to the boiler.



Models:

- MWC116ENT
- MWC116ELT
- MWC116ENL
- MWC116ELL

WARNING: Improper installation, adjustment, alteration, service or maintenance can cause property damage, injury, or loss of life. For assistance or additional information, consult a qualified installer, service agency or the gas supplier. This boiler requires a special venting system. Read these instructions carefully before installing.

CROWN Boiler Co.

Manufacturer of Hydronic Heating Products

P.O. Box 14818 3633 I. Street

Philadelphia, PA 19134

Tel: (215) 535-8900 • Fax: (215) 535-9736 • www.crownboiler.com

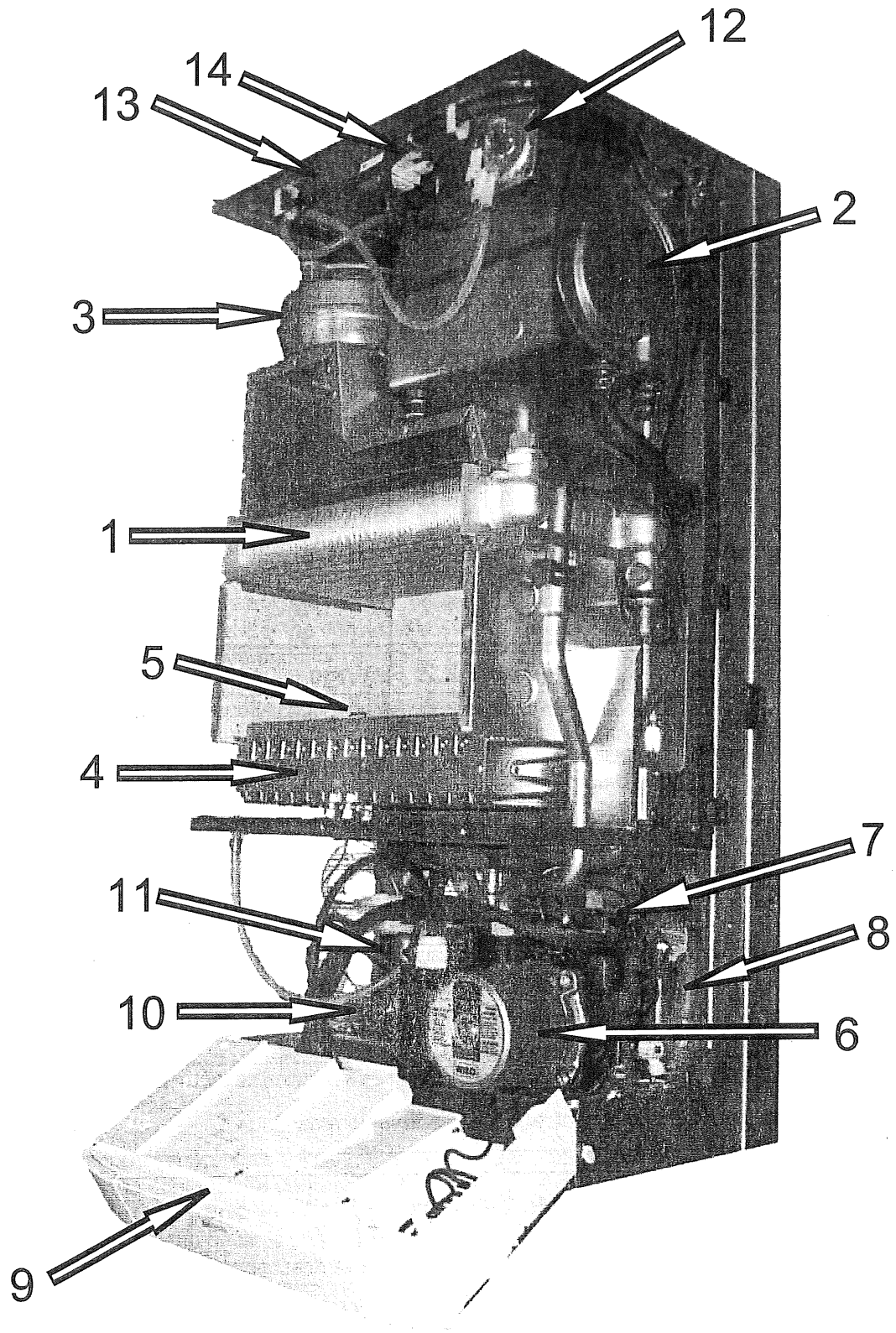

Figure 1.1: MWC Boiler Principle Components

II Specifications

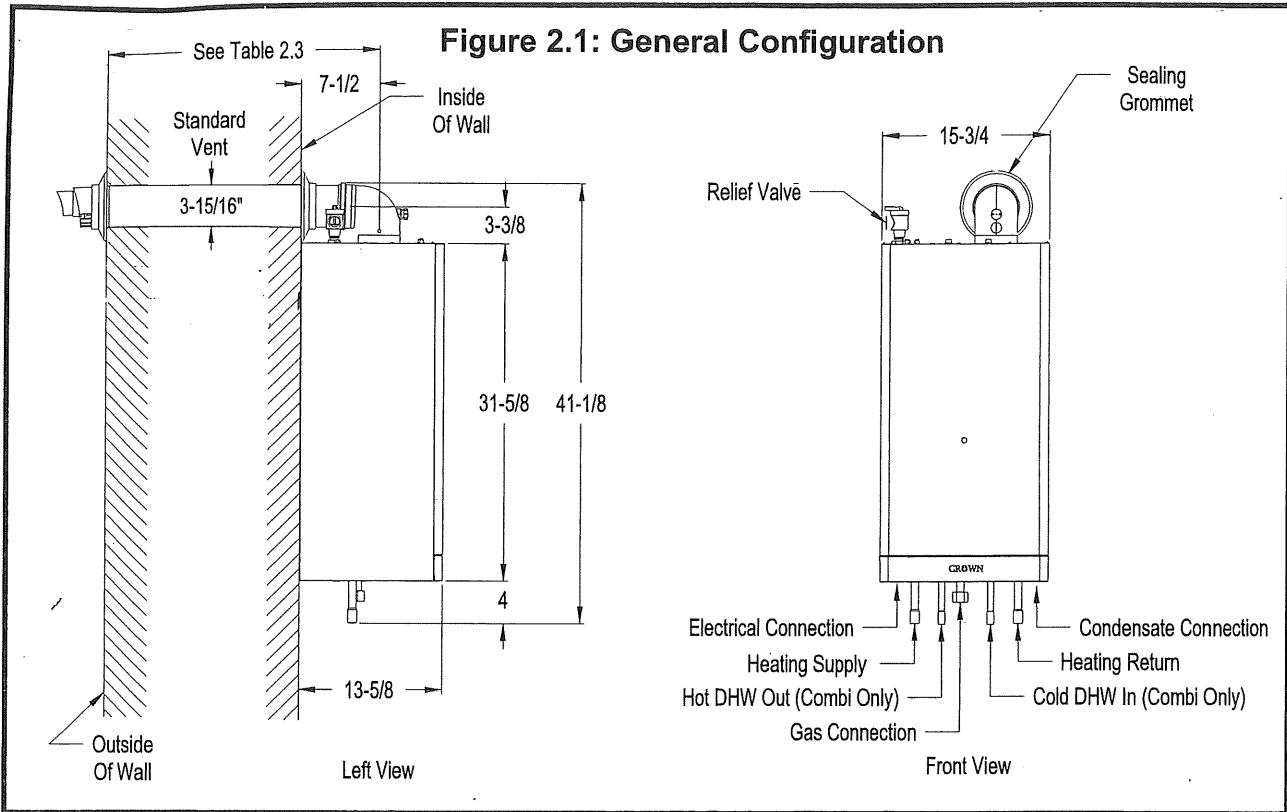

Table 2.2: Ratings

MODEL*	APPLICATION	MAX. INPUT (BTU/hr)	MINIMUM INPUT (BTU/hr)		D.O.E. HEATING CAPY. (BTU/hr)	IBR NET RATING (BTU/hr)	AFUE (%)	DHW Output (GPM)	
			HEATING	DHW				77F Rise	90F Rise
MWC116E*T	Combi	116,000	75,000	49,500	102,000	89,000	85.0	2.67	2.25
MWC116E*L	Heat Only	116,000	75,000	N/A	102,000	89,000	85.0	N/A	N/A

* Insert suffix "N" for natural gas and "L" for propane. Ratings are the same for both fuels (Example: MWC116ENT denotes Natural Gas, Combi).

Table 2.3: Maximum Vent Lengths

Using 60/100mm Concentric Vent System Supplied with the Boiler	25 in.
Using Optional 60/100mm Concentric Vent Components	8ft -10in
Using Optional 80/125mm Concentric Vent Components	27 ft

See Vent Section for additional venting options and requirements

Table 2.4: Other Specifications

Maximum Supply Temperature.....	176 F
Minimum Continuous Return Temperature.....	86F
Maximum Allowable Working Pressure	30 psi
Minimum System Pressure (at boiler)	4.4 psi
Maximum Achievable Flow Through Boiler	5.5 GPM
Minimum Temperature Rise Across Boiler at High Fire	37 F
Maximum Gas Inlet pressure	10.5" Nat / 13.0" LP
Minimum Gas Inlet Pressure	5.3" Nat / 10.5" LP
Electrical Ratings.....	120VAC/60Hz/1.8A
Thermostat Voltage	120VAC

PLUMBING APPLICATION

PROPERTY ADDRESS

City, Town, or Plantation: PORTLAND ME.
 Street or Road: 3 GEORGE AVE
 Subdivision, Lot #: 402 D 003

>> CAUTION: LPI APPROVAL REQUIRED <<

Town/City: Portland Permit #: 2011081835
 Date Permit Issued: 2/21/12 Fee: \$ _____ Double Fee Charged ()
 L.P.I. #: 360
 Local Plumbing Inspector Signature: _____

PROPERTY OWNERS NAME

Name (last, first, MI): DIVERSIFIED PROPERTIES Owner
LYMAN, M.E. 04002 Applicant
 Mailing Address of Owner/Applicant: P.O. Box 255
 Daytime Tel. #: 207-467-1889

The Internal Plumbing Fixtures and Piping shall not be installed until a Permit is issued by the Local Plumbing Inspector. The Permit shall authorize the owner or installer to install the plumbing system in accordance with this application and the Maine Internal Plumbing Rules.

CAUTION: INSPECTION REQUIRED

I have inspected the installation authorized above and found it to be in compliance with the Maine Plumbing Rules.

OWNER OR APPLICANT STATEMENT
 I state and acknowledge that the information submitted is correct to the best of my knowledge and understand that any falsification is reason for the Department and/or Local Plumbing Inspector to deny a Permit.
 Signature of Owner or Applicant: _____ Date: 2/21/12

Date Approved (Rough-in)

Local Plumbing Inspector Signature

Date Approved (Final)

PERMIT INFORMATION

This Application Is For

- 1. NEW PLUMBING INSTALLATION
- 2. RELOCATED PLUMBING

Type of Structure To Be Served

- 1. SINGLE FAMILY DWELLING
- 2. MODULAR OR MOBILE HOME
- 3. MULTIPLE FAMILY DWELLING
- 4. OTHER-SPECIFY _____

Plumbing To Be Installed By

- 1. MASTER PLUMBER
- 2. MFG'D HOUSING DEALER/MECHANIC
- 3. PUBLIC UTILITY EMPLOYEE
- 4. PROPERTY OWNER

LICENSE # 077096

Hook-Up & Piping Relocation
 Maximum of 1 Hook-Up

HOOK-UP: to public sewer in those cases where the connection is not regulated and inspected by the local Sanitary District

OR

HOOK UP: to an existing subsurface wastewater disposal system

PIPING RELOCATION: of sanitary lines, drains, and piping without new fixtures

OR
 TRANSFER FEE (\$6.00)

Number	Column 2 Type of Fixture	Number	Column 1 Type of Fixture
<u>2</u>	Hosebibb / Sillcock	<u>1</u>	Bathtub (and Shower)
	Floor Drain	<u>1</u>	Shower (Separate)
	Urinal	<u>1</u>	Sink
	Drinking Fountain	<u>3</u>	Wash Basin
	Indirect Waste	<u>3</u>	Water Closet (Toilet)
	Waste Treatment Softener, Filter, etc.	<u>1</u>	Clothes Washer
	Grease / Oil Separator	<u>1</u>	Dish Washer
	Dental Cuspidor		Garbage Disposal
	Bidet		Laundry Tub
	Other: _____	<u>1</u>	Water Heater
	Fixtures (Subtotal) Column 2	<u>12</u>	Fixtures (Subtotal) Column 1
		<u>2</u>	Fixtures (Subtotal) Column 2
		<u>14</u>	Total Fixtures
			Fixture Fee
			Transfer Fee
			Hook-Up & Relocation Fee
			Permit Fee
		<u>140</u>	(Total)

RECEIVED
 FEB 21 2012
 Dept. of Environmental Protection

140
10
150

402 D 003



Certificate of Occupancy

CITY OF PORTLAND, MAINE

Department of Planning and Urban Development
Building Inspections Division



Location: 58 GERTRUDE AVE.

Issued to: DIVERSIFIED PROPERTIES

CBL: 402-D-003-001

Date Issued: 3/29/2012

This is to certify that the building, premises, or part thereof, at the above location, built-altered-changed as to use under Building Permit No. 2012-01-3082-CH OF USE, has had a final inspection, has been found to conform substantially to the requirements of the Building Code and the Land Use Code of the City of Portland, and is hereby approved for occupancy or use, limited or otherwise, as indicated below.

PORTION OF BUILDING OR PREMISES

ENTIRE

APPROVED OCCUPANCY

USE GROUP R-3, TYPE 5B, IRC 2009

Limiting Conditions: This Temporary Certificate of Occupancy expires on June 30, 2012, pending DRC approval.

Approved:

3-29-2012

(Date)

Inspector

Inspections Division Director

Notice: This certificate identifies the legal use of the building or premises, and ought to be transferred from owner to owner upon the sale of the property.



Certificate of Occupancy

CITY OF PORTLAND, MAINE

Department of Planning and Urban Development
Building Inspections Division



Location: GERTRUDE AVE

Issued to: Diversified Properties

CBL: 402-D-003-001

Date Issued: 6/28/2012

This is to certify that the building, premises, or part thereof, at the above location, built-altered-changed as to use under Building Permit No. 2011-08-1835-SF, has had a final inspection, has been found to conform substantially to the requirements of the Building Code and the Land Use Code of the City of Portland, and is hereby approved for occupancy or use, limited or otherwise, as indicated below.

PORTION OF BUILDING OR PREMISES

ENTIRE

APPROVED OCCUPANCY

USE GROUP R-3
SINGLE FAMILY DWELLING
TYPE 5/B
IBC 2009

Approved: _____
JUNE 26, 2012
(Date)

Inspector

Inspector, Division Director

Notice: This certificate identifies the legal use of the building or premises, and ought to be transferred from owner to owner upon the sale of the property.

Memorandum
Department of Planning and Development
Planning Division



TO: Inspections Department

FROM: Philip DiPierro, Development Review Coordinator

DATE: June 26, 2012

RE: C. of O. for # 58 Gertrude Avenue, Wolf Single Family Home
(Id#2011-08-1835-SF) (CBL 402 D 003001)

After visiting the site, I have the following comments:

Site work complete:

At this time, I recommend issuing a permanent Certificate of Occupancy.

Cc: Tammy Munson, Inspection Services Manager
Barbara Barhydt, Development Review Services Manager
File: 1 Solution

Post Office Box 10127
Portland, Maine 04104
207-773-4988
Fax 207-773-6875

**Diversified
Properties**

MEMO

TO: Tammy Munson

From: Jim Wolf

Fax:

Pages:

Phone:

Date: 3/23/12

Re: ⁵⁸ Gertrude Ave

CC:

Urgent **For Review** **Please Comment** **Please Reply** **Please Recycle**

As per my conversation with Don, these are the revised plans for 58 Gertrude Street.

*City Hall
3rd Floor
Building Dept*

402 D003

402 D003

RECEIVED
MAR 23 2012
Dept. of Building Inspections
City of Portland Maine



Triple 1-3/4" x 18" VERSA-LAM® 2.0 3100 SP

Floor Beam\FB03

BC CALC® 3.0 Design Report - US
Build 517

1 span | No cantilevers | 0/12 slope

Wednesday, February 22, 2012

Job Name: Gertrude St.
Address:
City, State, Zip: Portland, ME
Customer: Rufus Deering
Code reports: ESR-1040

File Name: Daryl.BCC
Description: FB03
Specifier:
Designer: Chipper Roberts
Company: Boise Structural Solutions
Misc:

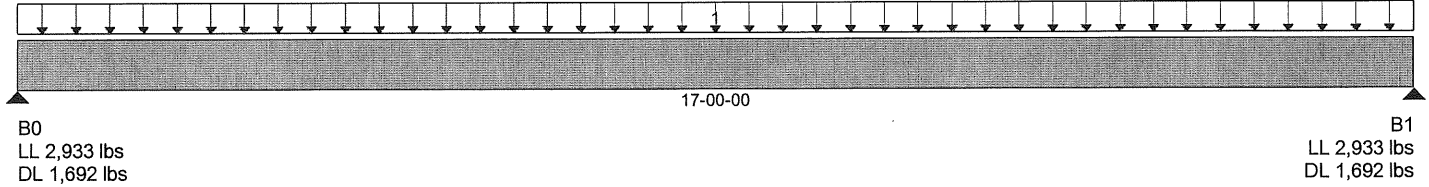

Total of Horizontal Design Spans = 17-00-00

Load Summary					Live	Dead	Snow	Wind	Roof Live	Trib.	
Tag	Description	Load Type	Ref.	Start	End	100%	90%	115%	133%	125%	
1	Standard Load	Unf. Area (psf)	L	00-00-00	17-00-00	30	15				11-06-00

Controls Summary	Value	% Allowable	Duration	Case	Span
Pos. Moment	19,656 ft-lbs	28.1%	100%	1	1 - Internal
End Shear	3,769 lbs	21.0%	100%	1	1 - Left
Total Load Defl.	L/1,018 (0.2")	23.6%		1	1
Live Load Defl.	L/1,606 (0.127")	22.4%		1	1
Max Defl.	0.2"	20.0%		1	1
Span / Depth	11.3	n/a			1

Disclosure

Completeness and accuracy of input must be verified by anyone who would rely on output as evidence of suitability for particular application. Output here based on building code-accepted design properties and analysis methods. Installation of BOISE engineered wood products must be in accordance with current Installation Guide and applicable building codes. To obtain Installation Guide or ask questions, please call (800)232-0788 before installation.

BC CALC®, BC FRAMER®, AJS™, ALLJOIST®, BC RIM BOARD™, BCI®, BOISE GLULAM™, SIMPLE FRAMING SYSTEM®, VERSA-LAM®, VERSA-RIM PLUS®, VERSA-RIM®, VERSA-STRAND®, VERSA-STUD® are trademarks of Boise Cascade Wood Products L.L.C.

Notes

- Design meets Code minimum (L/240) Total load deflection criteria.
- Design meets Code minimum (L/360) Live load deflection criteria.
- Design meets arbitrary (1") Maximum load deflection criteria.
- Minimum bearing length for B0 is 1-1/2".
- Minimum bearing length for B1 is 1-1/2".
- Entered/Displayed Horizontal Span Length(s) = Clear Span + 1/2 min. end bearing + 1/2 intermediate bearing

Connection Diagram

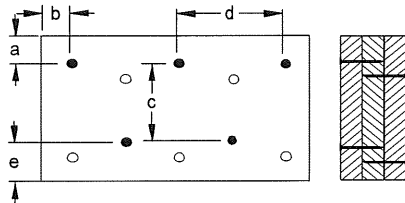

- a minimum = 2" c = 13"
- b minimum = 3" d = 24"
- e minimum = 3"

Nailing schedule applies to both sides of the member.
Member has no side loads.
Connectors are: 16d Sinker Nails