

DISPLAY THIS CARD ON PRINCIPAL FRONTAGE OF WORK



CITY OF PORTLAND BUILDING PERMIT



This is to certify that

HUNTINGTON APTS PARTNERSHIP /Eastern Fire
Services

Located at

326 AUBURN ST

PERMIT ID: 2013-00308

ISSUE DATE: 05/08/2013

CBL: 383 A016001

has permission to **install supervised fire alarm system for Building 2.**

provided that the person or persons, firm or corporation accepting this permit shall comply with all of the provisions of the Statutes of Maine and of the Ordinances of the City of Portland regulating the construction, maintenance and use of the buildings and structures, and of the application on file in the department.

Notification of inspection and written permission procured before this building or part thereof is lathed or otherwise closed-in. 48 HOUR NOTICE IS REQUIRED.

A final inspection must be completed by owner before this building or part thereof is occupied. If a certificate of occupancy is required, it must be procured prior to occupancy.

Fire Prevention Officer



Code Enforcement Officer / Plan Reviewer

**THIS CARD MUST BE POSTED ON THE STREET SIDE OF THE PROPERTY
THERE IS A PENALTY FOR REMOVING THIS CARD**

City of Portland, Maine - Building or Use Permit

389 Congress Street, 04101 Tel: (207) 874-8703, Fax: (207) 874-8716

Permit No: 2013-00308	Date Applied For: 02/15/2013	CBL: 383 A016001
---------------------------------	--	----------------------------

Location of Construction: 326 AUBURN ST	Owner Name: HUNTINGTON APTS PARTNERS	Owner Address: PO BOX 1003	Phone:
Business Name:	Contractor Name: Eastern Fire Services	Contractor Address: 170 Kittyhawk Ave, PO Box 1582 Au	Phone (207) 784-1507
Lessee/Buyer's Name	Phone:	Permit Type: Fire Alarm System	

Proposed Use: Multi unit apartment building	Proposed Project Description: install supervised fire alarm system for Building 2.
---	--

Dept: Zoning **Status:** Approved **Reviewer:** Ann Machado **Approval Date:** 02/19/2013
Note: **Ok to Issue:**

Dept: Fire **Status:** Approved w/Conditions **Reviewer:** Ben Wallace Jr **Approval Date:** 05/07/2013
Note: Waiting for info **Ok to Issue:**

- 1) System CO detectors shall activate an audible alarm at the detector and FACP, and send an alarm signal the remote station. It shall not trip the master box.
- 2) The fire alarm technician shall be present for the fire inspection. System acceptance and commissioning must be coordinated with alarm and suppression system contractors and the Fire Department. Call 874-8703 to schedule.
- 3) Through-penetrations and membrane penetrations in fire walls, fire barrier walls, and fire resistance rated horizontal assemblies shall be protected by firestop systems or devices in conformance with NFPA 101:8.3.5 (ASTM E 814 or ANSI/UL 1479). Providing firestop labels at each firestop system or device and an onsite manual containing the detail for each firestop system or device used for the project will streamline final inspection approvals.
- 4) All smoke detectors shall be photoelectric.
- 5) The installation shall comply with the following:
 City of Portland Chapter 10, Fire Prevention and Protection;
 NFPA 1, Fire Code (2009 edition), as amended by City Code;
 NFPA 101, Life Safety Code (2009 edition), as amended by City Code;
 City of Portland Fire Department Rules and Regulations;
 NFPA 72, National Fire Alarm and Signaling Code (2010 edition), as amended by Fire Department Rules and Regulations; and
 NFPA 70, National Electrical Code (2011 edition) as amended by the State of Maine
- 6) The fire alarm system shall have a new fire alarm inspection sticker.
- 7) In field installation shall be installed per code as conditions dictate.
- 8) Fire protection systems shall be maintained. If system is to be off line over 4 hours a fire watch shall be in place. Dispatch notification required 874-8576.
- 9) Automatic fire detection devices shall be installed as follows:
 (1) Smoke detectors shall be installed in all common areas and work spaces outside the living unit, such as exit stairs, egress corridors, lobbies, storage rooms, equipment rooms, and other tenantless spaces in environments suitable for proper smoke detector operation.
 (2) Heat detectors shall be located within each room of the living unit (exception: bathrooms not exceeding 55 ft² and closets not exceeding 24 ft² and no more than 3 ft. deep).
- 10) All fire alarm records required by NFPA 72 should be stored in an approved cabinet located at the FACP labeled "FIRE ALARM RECORDS".
- 11) Records cabinet, FACP, annunciator(s), and pull stations shall be keyed alike.
- 12) Supervising Station monitoring for addressable fire alarm systems shall be by point.

Location of Construction: 326 AUBURN ST	Owner Name: HUNTINGTON APTS PARTNERS	Owner Address: PO BOX 1003	Phone:
Business Name:	Contractor Name: Eastern Fire Services	Contractor Address: 170 Kittyhawk Ave, PO Box 1582 Au	Phone (207) 784-1507
Lessee/Buyer's Name	Phone:	Permit Type: Fire Alarm System	

13 A 4100 series Knox Box is required.

14 A master box connection and drill switch is required. AES Zones shall be:

1. Not assigned
2. Not assigned
3. Pull stations and detectors
4. City Disconnect: Pull stations and detectors
5. Not assigned
6. Not assigned
7. Not assigned
8. AES tamper switc

15 Notice: The first scheduled final inspection fee is at no charge. Additional inspections shall be billed at \$75 for each inspector.

16 Manual Pull Stations are required per NFPA 101:30.3.4.2.1 at all exit doorways and within 200 feet of travel.

City of Portland, Maine - Building or Use Permit Application

389 Congress Street, 04101 Tel: (207) 874-8703, Fax: (207) 874-8716

Permit No: 2013-00308	Issue Date:	CBL: 383 A016001
--------------------------	-------------	---------------------

Location of Construction: 326 AUBURN ST	Owner Name: HUNTINGTON APTS PARTNERSHIP	Owner Address: PO BOX 1003 PORTLAND, ME 04104	Phone:
Business Name:	Contractor Name: Eastern Fire Services	Contractor Address: 170 Kittyhawk Ave, PO Box 1582 Auburn ME 04211	Phone: (207) 784-1507
Lessee/Buyer's Name	Phone:	Permit Type: Fire Alarm System	Zone: R5
Past Use: Multi unit apartment building	Proposed Use: Multi unit apartment building	Permit Fee: \$320.00	Cost of Work: \$30,000.00
Proposed Project Description: Fire Alarm system for Building 2		FIRE DEPT: <input checked="" type="checkbox"/> Approved <input type="checkbox"/> Denied <input type="checkbox"/> N/A 5/7/13	INSPECTION: Use Group: Type:
		Signature: <i>[Signature]</i> (58)	Signature:
PEDESTRIAN ACTIVITIES DISTRICT (P.A.D.)			
Action: <input type="checkbox"/> Approved <input type="checkbox"/> Approved w/Conditions <input type="checkbox"/> Denied			
		Signature:	Date:

Permit Taken By: bjs	Date Applied For: 02/15/2013	Zoning Approval	
--------------------------------	--	------------------------	--

- This permit application does not preclude the Applicant(s) from meeting applicable State and Federal Rules.
- Building permits do not include plumbing, septic or electrical work.
- Building permits are void if work is not started within six (6) months of the date of issuance. False information may invalidate a building permit and stop all work..

Special Zone or Reviews <input type="checkbox"/> Shoreland <input type="checkbox"/> Wetland <input type="checkbox"/> Flood Zone <input type="checkbox"/> Subdivision <input type="checkbox"/> Site Plan Maj <input type="checkbox"/> Minor <input type="checkbox"/> MM <input type="checkbox"/> Date: <i>OK</i> 2/19/13 <i>ABU</i>	Zoning Appeal <input type="checkbox"/> Variance <input type="checkbox"/> Miscellaneous <input type="checkbox"/> Conditional Use <input type="checkbox"/> Interpretation <input type="checkbox"/> Approved <input type="checkbox"/> Denied Date:	Historic Preservation <input checked="" type="checkbox"/> Not in District or Landmark <input type="checkbox"/> Does Not Require Review <input type="checkbox"/> Requires Review <input type="checkbox"/> Approved <input type="checkbox"/> Approved w/Conditions <input type="checkbox"/> Denied Date: <i>ABU</i>
--	---	---

The updated and approved plans are in E-Plan and the 6 drive.

CERTIFICATION

I, the named property, or that the proposed work is authorized by the owner of record and his application as his authorized agent and I agree to conform to all applicable laws of described in the application is issued, I certify that the code official's authorized areas covered by such permit at any reasonable hour to enforce the provision of the

ADDRESS	DATE	PHONE
RESPONSIBLE PERSON IN CHARGE OF WORK, TITLE	DATE	PHONE



Fire Alarm Permit

If you or the property owner owes real estate or property taxes or user charges on any property within the city, payment arrangements must be made before permits of any kind are accepted.

Installation address: 326 Auburn St #2 CBL: _____

Exact location: (within structure) _____

Type of occupancy(s) (NFPA & ICC): Residential (Multi Unit Apartment Building)

Building owner: Gary Sidelinger

System Designer (point of contact): Marc Tardif
Must be

Designer phone: 207-784-1507 E-mail: tardifml@efp-efs.com

Installing contractor: Eastern Fire Services Certificate of Fitness No: M1024

Contractor phone: 207-784-1507 E-mail: malcolmcr@efp-efs.com

This is a new application: YES NO New AES Master Box: YES NO
(Include Master Box approval form)

Amendment to an existing permit: YES NO Permit no: _____

The following documents shall be provided with this application:

- Floor plans
- Wiring diagram
- Annunciator details
- Input/ Output Matrix
- Equipment data sheets
- Electrical Permit Pulled (check alarm/com)
- Scope of Work
- 11 1/2 x 17s
- pdf copy (may be e-mailed)
- Designer qualifications
- Battery/ voltage drop calcs

Master box approval only: YES NO
(If yes check *New AES Master Box* above)

COST OF WORK: 30,000

PERMIT FEE: 320.
(\$10 PER \$1,000 + \$30 FOR THE FIRST \$1,000)

RECEIVED

FEB 15 2013

Dept. of Building Inspections
City of Portland Maine

The designer shall be the responsible party for this application. Download a new copy of this application at www.portlandmaine.gov/fire for every submittal. Submit all plans in electronic PDF in addition to readable 11 1/2 x 17s to the Building Inspections Department, 389 Congress Street, Room 315, Portland, Maine 04101.

Prior to acceptance of any fire alarm system, a complete commissioning and acceptance test must be coordinated with all fire system contractors and the Fire Department, and proper documentation of such test(s) provided.

All installation(s) must comply with the *City of Portland Technical Standard for Signaling Systems for the Protection of Life and Property*, available at www.portlandmaine.gov/fire.

Applicant signature: _____ Date: _____

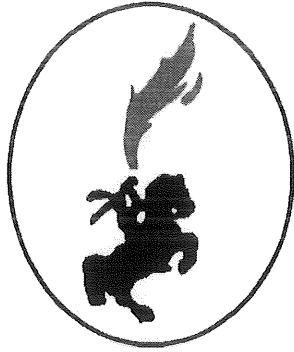

SUBMITTAL DOCUMENTS

FOR

HUNTINGTON APTS BUILDING 2

PORTLAND, ME

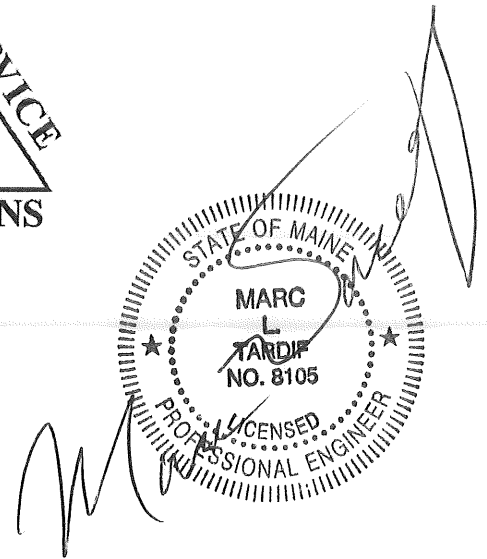

Serving Maine Since 1942

Eastern Fire Protection Co.
Eastern Fire Services, Inc.

RESIDENTIAL * COMMERCIAL * INDUSTRIAL
 24 HOUR SERVICE
 Installation/Design/Testing/Inspections/Maintenance

<p>Auburn 207-784-1507 800-434-4337 170 Kittyhawk Ave.</p>	<p>FIRE SPRINKLER FIRE ALARM CLEAN AGENT GAS DETECTION</p>	<p>Bangor 207-942-8014 800-866-8014 408 Harlow St.</p>
<p>SIEMENS Fire Alarm</p>	<p>www.efp-efs.com</p>	<p>ENMET Gas Detection</p>

CONTRACT WITH: OWNER

TABLE OF CONTENTS

CATALOG CUTS AND DESCRIPTIVE LITERATURE

1. SCOPE OF WORK
2. I/O DIAGRAMS
 - a. PHASE I
 - b. PHASE II
3. SIEMENS EQUIPMENT CATALOG CUTS
 - a. FS-250 – FIRE ALARM CONTROL PANEL
 - b. FS-DACT – DIGITAL COMMUNICATOR
 - c. FS-RD2 – REMOTE ANNUNCIATOR
 - d. HFP-11 – ADDRESSABLE SMOKE DETECTOR
 - e. HFPT-11 – ADDRESSABLE HEAT DETECTOR
 - f. DB-11 – DETECTOR BASE
 - g. DT-135R – 135 FT/ROR HEAT DETECTOR
 - h. DT-200F – 200 FT HEAT DETECTOR
 - i. MSM-KD – MANUAL PULL STATION
 - j. HTRI-M – SINGLE INPUT MINI MONITOR MODULE
 - k. HTRI-S – SINGLE INPUT MONITOR MODULE
 - l. ZH-MC-R – FIRE ALARM HORN/STROBE
 - m. ZR-MC-R – FIRE ALARM STROBE
 - n. ZH-R – FIRE ALARM HORN
4. DSX EQUIPMENT CATALOG CUT
 - a. GS3055-ICF – CELLULAR COMMUNICATOR
5. VOLTAGE DROP AND BATTERY CALCULATIONS
6. SYSTEM DRAWINGS

End of Table of Contents

To: Portland Fire Department

From: Colby Malcolm

Re: 326 Auburn St (Huntington Apartments) Scope of Work – Building 2

Date: 1/25/12

326 Auburn St is composed of two separate buildings each composed of 24 one to two bedroom units. Currently the building is equipped with a local fire alarm system comprised of heat detection, manual means, and evacuation signals in common areas. The documentation enclosed in this package shows the proposal for a two phase upgrade to a new monitored fire alarm system.

Phase I: Phase I is to replace the existing conventional FACP with the proposed new addressable FACP. Conventional zone modules will be used to monitor existing devices for alarm, trouble, and supervisory while installation of new addressable devices is going on.

Phase II: Phase II is to install new addressable devices throughout the building for current code compliance. Once new devices are in place the old conventional ones will be disconnected and the new ones connected, finalizing the transition to a new complete fire alarm system in compliance with the City of Portland fire alarm requirements for existing apartment buildings.

If there are any questions about the scope of work or any enclosed documentation please feel free to call or email at any time. Thank you

Colby Malcolm

Eastern Fire Services

(207) 784-1507 ext. 242

malcolmcr@efp-efs.com

HUNTINGTON APTS ALARM INPUT/OUTPUT MATRIX PHASE II

System Inputs	Activate Alarm LED on FACP	Activate Local Alarm Audible Signal	Activate Supervisory LED on FACP	Activate Local Supervisory LED on FACP	Activate Trouble LED on FACP	Indicate System Status & Location on FACP	Activate Audible/Visual Evacuation Signals in Common Areas	Activate Alarm LED on Remote Annunciator	Activate Supervisory LED on Remote Annunciator	Indicate Trouble LED on Remote Annunciator	Transmit System Status and Location on Remote Display	Transmit Alarm Signal to Central Station	Transmit Supervisory Signal to Central Station	Transmit Trouble Signal to Central Station
Manual Pull Station	X	X				X	X	X	X	X				
Smoke Detector	X	X				X	X	X	X	X				
Heat Detector	X	X				X	X	X	X	X				
Low Battery				X	X	X					X	X	X	X
Loss of AC Power				X	X	X					X	X	X	X
Open Circiut				X	X	X					X	X	X	X
Short Circuit				X	X	X					X	X	X	X
Ground Fault				X	X	X					X	X	X	X

FireSeeker Fire Alarm System

Addressable Fire Alarm Control Panel Model FS-250

ARCHITECT AND ENGINEER SPECIFICATIONS

- One (1) Intelligent Signaling Line Circuit (Style 4 or Style 6)
- SLC loop supports up to 252 addressable Inputs and signal / relay outputs
— 504 total inputs / outputs
- *SureWire™* polarity insensitive addressable-device loop wiring
- Devices operate on standard wire; no twist or shield required
- *FirePrint™* application-specific fire detection
- Four (4) Class B – Style Y / Two (2) Class A – Style Z notification-appliance circuits
- Up to 6 Amps. – NAC Power
- Built-in strobe synchronization protocol
- 80-character backlit LCD display
- One-man walk test (Silent or Audible)
- Auto Program Feature makes system commissioning more efficient
- Up to four (4) remote LCD displays with control capabilities
- Easily programmable from front keypad or Windows®-based PC configuration tool (not required)
- Maintenance and technician-level passwords for added security
- Optional internal DACT and city-tie module
- Up to 2,000-event history log
- Manual fan-restart feature

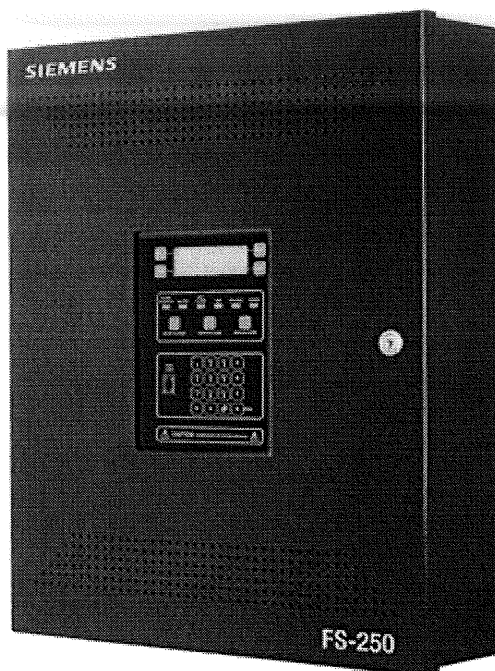

- Made in the USA, ISO 9001 quality crafted
- Three (3) on-board, programmable relays, plus one (1) non-programmable *Fail / Safe* relay for *Trouble* events
- [®]UL 864 9th Edition Listed;
FM, CSFM & NYMEA Approved

Product Overview

The Model FS-250 Addressable Fire Alarm Control Panel is a low-cost, small panel suited for standalone operation in small-to-medium-sized facilities. Model FS-250 features a single, addressable input-device circuit and four (4) notification-appliance circuits. The Model FS-250 system is available in either a black or red enclosure, with operating controls and indicators behind a locked door. Model FS-250 is [®]UL 864 9th Edition Listed by Underwriters Laboratories.

Specifications

Model FS-250 indicates *Alarm*, *Trouble* and *Supervisory* conditions with an 80-character backlit LCD display and integral system status LEDs. *Acknowledge*;

Alarm Silence and *System Reset* commands are accomplished with built-in membrane control buttons. Basic user and maintenance-level functions, such as *Viewing History* or *System Enable / Disable*, are also accomplished through the membrane control buttons. Maintenance-level functions are password protected.

The main system for Model FS-250 can support up to 38 AH battery sets – up to 12 AH will fit inside the enclosure.

The basic Model FS-250 fire alarm control panel features a single, addressable signaling line circuit (Style 4 or 6); capable of supporting up to 252 addressable input devices – whether they are detectors, manual pull stations, or contact monitoring points.

FireSeeker Fire Alarm Control Panel (FS-250) **4306**

Specifications — (continued)

Each detector can also have an optional, audible-detector base, relay-detector base or remote lamp. These auxiliary devices are completely controlled through logic, and are not required to activate simultaneously with the detector.

The Model FS-250 system also has four (4) Class B notification-appliance circuits built into the main board, which can be configured as two (2) Class A circuits. Each circuit has a capacity of 1.5 amps of 24VDC for powering horns, strobes, chimes, and other notification appliances, and the total base-system capacity for the four (4) circuits is 3.0 amps — expandable to 6A max. Each NAC is fully programmable, and supports standard and custom-coded outputs of audible devices.

Model FS-250 control panel has three (3) programmable 'Form C' dry-contact relays. One (1) additional non-programmable 'Form C' dry-contact relay is provided that activates only on *Trouble* events — operating in *Fail / Safe* mode in order to activate if there is a system power failure. Each relay is rated at 1 amp @ 28VDC. Up to 0.5A auxiliary 24VDC power is also available on the Model FS-250 main board.

Minimum Control Unit Configuration Intelligent Signaling Line Circuit (SLC)

The main termination board for Model FS-250 has addressable-loop interface circuitry supporting one (1) SLC loop. Devices are polarity insensitive, and can operate on untwisted, unshielded wire.

Notification Appliance Circuits (NAC)

The Model FS-250 base panel has four (4) independent NACs. Each circuit can be configured to give continuous output, or one (1) of five (5) sounding patterns. NACs can be configured as: two (2) 'Class A — Style Z' or four (4) 'Class B — Style Y.'

Dry Contacts

Three (3) programmable 'Form C' dry-contact relays are provided on the Model FS-250 fire alarm control panel. One (1) additional 'Form C' dry-contact relay is provided that activates only on *Trouble* events. This relay operates in *Fail / Safe* mode, in order to activate if there is a power failure of the Model FS-250 system.

Power Supply

This component provides all operating power to the Model FS-250 panel for *Standby* and *Alarm* conditions.

Optional Control Unit Configuration Digital-Alarm Communication Transmitter (FS-DACT)

Communication between the FS-250 fire alarm control panel and a monitoring station is accomplished with Model FS-DACT, which supports two (2) lines and two (2) accounts, and can transmit serial data, by point, to the central or remote station.

Communication protocols available include:

- SIA DCS 8
- SIA DCS 20
- Ademco Contact ID
- 3/1 1400 Hz
- 3/1 2300 Hz
- 4/2 1400 Hz
- 4/2 2300 Hz

Model FS-DACT mounts within the Model FS-250 fire alarm control panel. Neither an external enclosure nor wires are required between the panel and the dialer. Programming of account and dialing data is done as part of the system configuration, and no external programmer for the dialer is required.

Municipal Tie / Leased Line (FS-MT)

For installations that require connection to a municipal call box or a leased line, the municipal tie module (Model FS-MT) is used. Model FS-MT provides a local-energy output for municipal call-box connection, and gives a reverse-polarity output for lease-line connection. Model FS-MT mounts within the FS-250 enclosure. Model FS-MT parameters are programmed at the time of system configuration.

Auxiliary Devices

Model FS-250 panel supports up to four (4) remote LCD displays and eight (8) serial annunciators or serial relay units.

Remote LCD Annunciator (FS-RD2)

Model FS-250 supports a remote LCD display — Model FS-RD2, which uses the same 80-character, backlit LCD display found on the main FS-250 fire alarm control panel. Model FS-RD2 has remote *Acknowledge*, *Alarm Silence*, and *System Reset* capability that is secured with a keyswitch. User-level functions are accessible from Model FS-RD2.

Model FS-RD2 communicates with Model FS-250's main system board, via a RS-485 communication network. Up to four (4) Model FS-RD2 remote displays can be supported on a single FS-250 fire alarm control panel. Model FS-RD2 mounts in a 2"-deep, 6-gang electrical box, and the plate on the display is suitable for flush mounting.

Programmable Remote Relays (FS-RU2)

Programmable relays are available on the Model FS-250 control panel. A remote processor board (Model FS-RU2) communicates with the main system board, via a RS-485 communication network. Model FS-RU2 processor board controls a relay board mounted adjacent to it.

Specifications — (continued)

The relay board has eight (8) Form C relay contacts – rated at 1 amp at 28VDC maximum. Model FS-RU2 relay unit contains one (1) processor board and one (1) relay board, totaling eight (8) relays.

Each processor board can support up to three (3) relay boards simultaneously, totaling 24 programmable relays per processor board. Additional relay extender boards are available, Model FS-RE8. A total of eight (8) processor boards can be supported simultaneously by each FS-250 control panel.

Programmable Serial Annunciator Drivers (FS-SAU2)

Programmable serial annunciator drivers are available on the Model FS-250 control panel. A remote processor board communicates with the main system board, via a RS-485 communication network. This processor board controls a serial-annunciator driver board mounted adjacent to the remote processor board. The driver board has 16 outputs for LEDs. All serial-annunciator outputs are supervised.

Model FS-SAU2 serial-annunciator unit contains one (1) processor board and one (1) serial-annunciator driver board to add 16 LED drivers. Each processor board can support up to four (4) additional driver boards simultaneously, totaling 64 programmable serial-annunciator drivers per processor board.

Additional serial annunciator extender boards are available as Model FS-SAE16. A total of eight (8) processor boards can be supported simultaneously by each Model FS-250 control panel.

Programming / Configuration Options

Configuration of the FS-250 control panel can be accomplished in two ways: First, the operator interface includes a 16-button keypad. This keypad can be used to configure all system parameters – including custom messages and logic – directly at the panel with no other configuration tools. Secondly, the Model FS-CT2 configuration tool can be used on a laptop computer to upload, download, and edit the system configuration.

Model FS-CT2 configuration tool includes a connection cable for use between the FS-250 fire alarm control panel and a 9-pin serial connection on a laptop computer running Model FS-CT2 software. Use of Model FS-CT2 software requires a computer that runs on a Windows®-based PC operating system. Model FS-CT2 configuration tool can be used to generate configuration reports and download and print history.

Custom messages for system addresses consist of two (2) lines – 20 characters per line. The characters include upper and lower case letters as well as numbers, punctuation marks, and control characters. This 40-character custom message will be displayed for all events at that address.

Technical Data

Environmental:	Operating Temperature: 32-120°F (0-49°C) Relative Humidity: up to 93% @ 90°F (32°C)
Primary Power Supply:	Primary Input Voltage: 120 VAC (60 Hz.) Maximum Primary Input Current: 2.4 Amps. @ 120 VAC
Secondary Power Supply:	24-volt, lead-acid battery with 7AH - 38AH capacity
Auxiliary Power Outputs:	Current - 0.5 Amp with resettable and non-resettable power outputs
System Status Relays:	Four (4) relays rated @ 1 Amp, 28 VDC resistive
Notification Appliance Circuits:	Rating per NAC circuit, 1.5A each, 6A max.
Battery:	Base cabinet accommodates a 12 AH battery set. Larger batteries require separate enclosures.

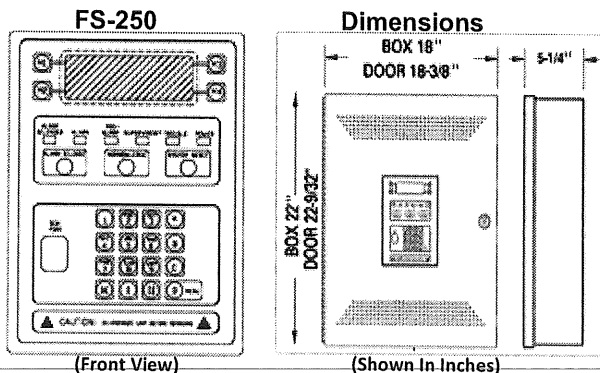

Details for Ordering

Model Number	Part Number	Description
FS-250-EKIT	599-050586	FS-250 Electronics Package Includes: FS-250-CON (1 Qty.) FS-NPE (2 Qty.)
FS-250-ENCL	500-648952	FS-250 Enclosure, Black
FS-250-ENCL-R	500-648953	FS-250 Enclosure, Red

Optional Accessories

Model Number	Part Number	Description
FS-RD2-R	500-649400	Remote Annunciator, Red
FS-RD2	500-648980	Remote Annunciator, Black
FS-RU2	500-649308	Relay Processor Card
FS-RE8	500-699467	8-Relay Extender
FS-SAU2	500-649307	Serial Annunciator Processor Card
FS-SAE16	500-699469	16-Output Annunciator Extender
FS-DACT	500-699464	Serial Digital Alarm Comm. Transmitter (DACT)
FS-MT	500-699462	Municipal Tie Module
FS-SFT-R	500-648955	Semi-Flush Trim, Red
FS-SFT	500-648954	Semi-Flush Trim, Black
FS-NPE	500-649120	NAC Power Expander Transformer
HFPO-11	500-034800	Photo-Only Detector

Wiring Diagram Main Termination Board

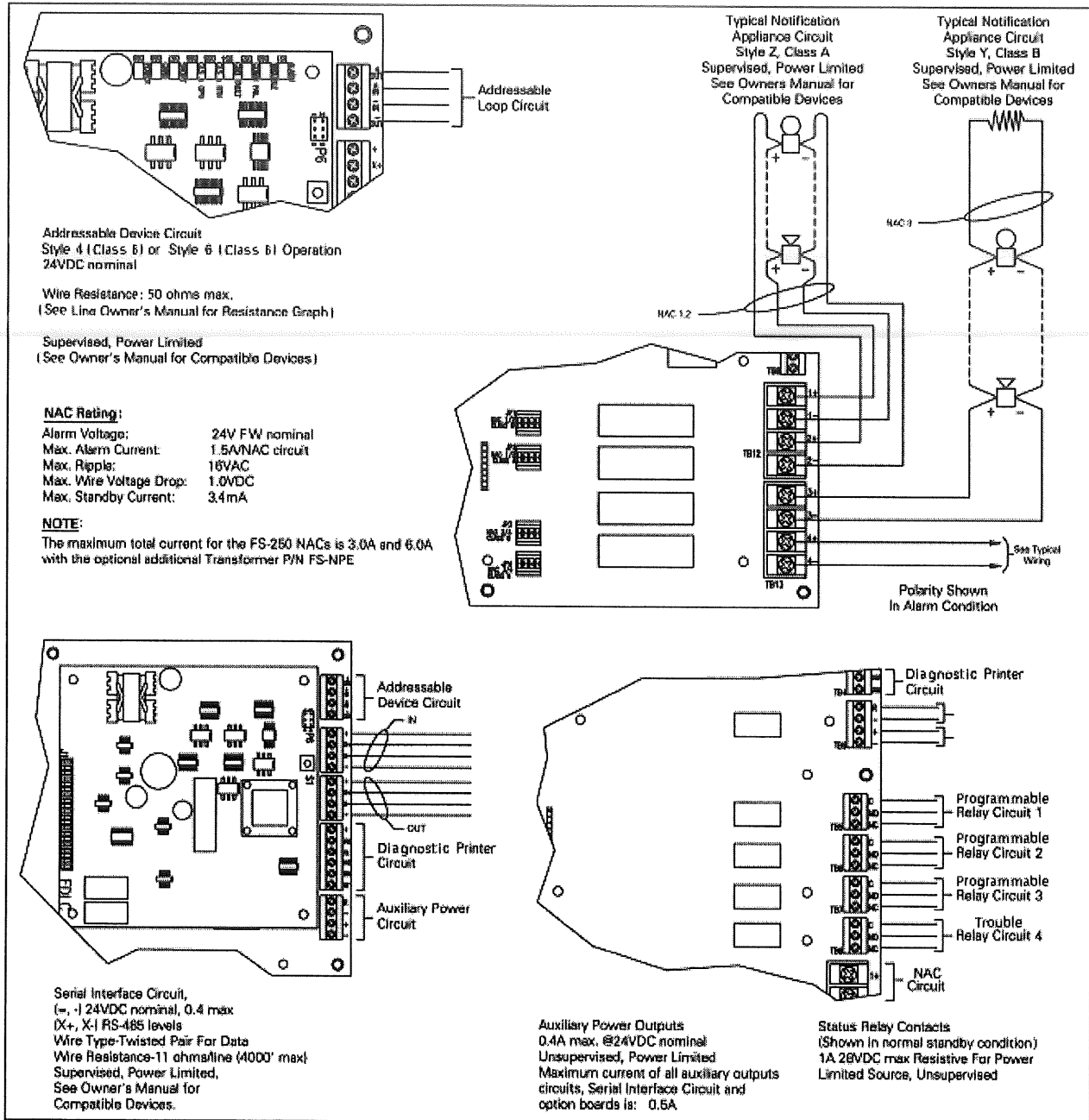

Notice: This marketing catalog sheet is not intended to be used for system design or installation purposes. For the most up-to-date information, refer to each product's installation instructions.

SIEMENS

Fire Safety

FS-DACT

Digital Alarm Communication Transmitter for the FireSeeker FS-250 System

ENGINEER AND ARCHITECT SPECIFICATIONS

-  UL Listed for Central Station/Remote Station Monitoring (NFPA 72 Chapter 4)
- Four separate monitoring accounts available
- Two phone lines available
- Can send serial information to monitoring station
- Reports in 8 standard communication formats
- Automatic 24 hour test available
- Mounts within the FS-250 enclosure directly on the main processor board
- All programming is done as part of the FS-250 configuration

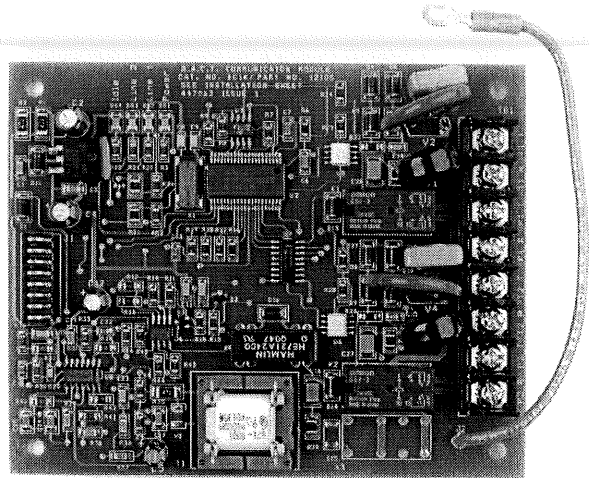

The Model FS-DACT Digital Alarm Communication Transmitter is used to provide communication between the FS-250 and a central or remote monitoring station. The FS-DACT supports two lines and four accounts, and can transmit serial information (including the address of the event) to the monitoring station. Any of the accounts can send alarm, supervisory, trouble, reset, or trouble restore information (or any combination) as required. Communication protocols available include SIA DCS 8, SIA DCS 20, Ademco Contact ID, 3/1 1400 Hz, 3/1 2300 Hz, 4/2 1400 Hz and 4/2 2300 Hz. The FS-DACT can perform the automatic 24 hour test required by NFPA.

The FS-DACT mounts within the FS-250 enclosure on an 8-pin connection point on the main board. No external enclosure is required, and no wires are required between the panel and the dialer. Programming of account and dialing information is done as part of the system configuration. No external programmer for the dialer is required, and dialer information can be downloaded as part of the system configuration.

Ordering Information

Model Number	Description	Part Number
FS-DACT	Digital dialer for the FS-250	500-699464

NOTICE: The use of other than Fire Safety detectors and bases with Fire Safety equipment will be considered a misapplication of Fire Safety equipment and as such voids all warranties either expressed or implied in regard to loss, damage, liabilities and/or service problems.

Siemens Building Technologies
Fire Safety

Fire Safety
8 Fernwood Road
Florham Park, NJ 07932
Tel: (973) 593-2600
FAX: (973) 593-6670
Website: www.sbt.siemens.com/fis

1/04
5M
SFS-IG
Printed in U.S.A.

Fire Safety
2 Kenview Boulevard
Brampton, Ontario
Canada L6T 5E4
Tel: (905) 799-9937
FAX: (905) 799-9858

January 2004
Supersedes sheet dated 6/03



Remote LCD Annunciator for the FireSeeker FS-250 System

ENGINEER AND ARCHITECT SPECIFICATIONS

- 4 x 20 Character Backlit Display
- System Status LEDs
- Optional local sounder
- Built-in lamp test button
- Integral System Control Capabilities (with keyswitch)
- Integral System Maintenance access (with keyswitch and password)
-  UL Listed

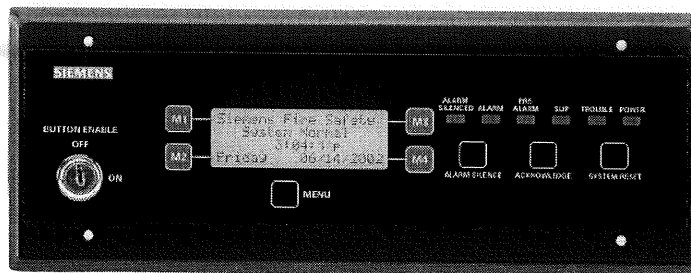

The Model FS-RD2 Remote Display is used for annunciating system events remotely from the fire alarm control panel on the FireSeeker FS-250 system. The FS-RD2 will mimic the system status LEDs and the 80-character event message found on the main system panel. The 4 x 20 LCD backlit display will illuminate upon receiving any event from the system, or upon pressing any button on the FS-RD2.

System Acknowledge, Silence and Reset Capabilities are available on the FS-RD2. The control functions must be enabled using the integral keyswitch. Up to sixteen supervised FS-RD2 annunciators can be used simultaneously on the FireSeeker FS-250 system.

Mounting is accomplished using a standard 6 gang 2" deep electrical box. The FS-RD2 requires a 2-wire data connection from the RS-485 port on the FS-250, as well as 24VDC power. Maximum wire loop resistance is 25 ohms.

Ordering Information

Model Number	Description	Part Number
FS-RD2	Remote LCD display for the FS-250	500-648980

NOTICE: The use of other than Fire Safety detectors and bases with Fire Safety equipment will be considered a misapplication of Fire Safety equipment and as such voids all warranties either expressed or implied in regard to loss, damage, liabilities and/or service problems.

Siemens Building Technologies
Fire Safety

Fire Safety
8 Fernwood Road
Florham Park, NJ 07932
Tel: (973) 593-2600
FAX: (973) 593-6670
Website: www.sbt.siemens.com/fis

1/04
5M
SFS-IG
Printed in U.S.A.

Fire Safety
2 Kenview Boulevard
Brampton, Ontario
Canada L6T 5E4
Tel: (905) 799-9937
FAX: (905) 799-9858

January 2004
Supersedes sheet dated 6/03

FireFinder XLS & FS-250 Control Panels

Addressable *FirePrint*[™] Detector

Model HFP-11

ARCHITECT AND ENGINEER SPECIFICATIONS

- Most sophisticated 'detector intelligence' available
- Multi-criteria fire detection for the price of a photoelectric detector
- *FirePrint*[™] technology to differentiate between deceptive phenomena and an actual fire
- Easily programmed to match specific hazard profiles from the control panel
- Polarity insensitive utilizing *SureWire*[™] technology
- Pre-alarm reporting based on fire profile selected
- Remote sensitivity-measurement capability
- System logic activation based on any of three (3) inputs from the detector (smoke, heat or neural network)
- Detectors are self-testing:
 - complete diagnostics every four (4) seconds
- Two-wire operation
- Multi-color detector status LED
- Field-cleanable chamber with replaceable chamber parts available
- Compatible with Model DPU (device programmer / tester unit)
- Supports software-based automatic environmental compensation
- Optional fully programmable relay base, audible base and duct housing
- [®]UL and [®]ULC Listed;
FM, CSFM & NYMEA Approved

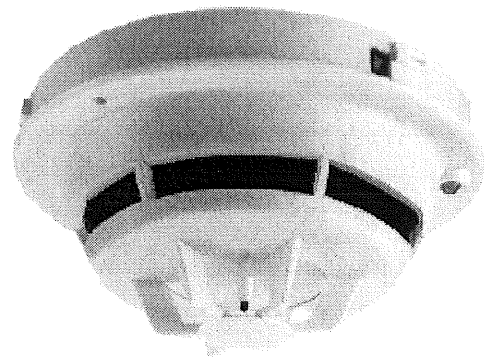

Product Overview

Model HFP-11 utilizes advanced detection technology that allows the detector to distinguish non-threatening deceptive phenomena – such as cigarette smoke, from actual fire hazards, while optimizing detection for the area it is intended to detect. Model HFP-11 uses state-of-the-art microprocessor circuitry with error check, detector self-diagnostics and supervision programs.

Model HFP-11 is compatible with the Siemens – Fire Safety field device program / test unit (Model DPU), which is a compact, portable, menu-driven accessory for electronically programming and testing detectors, easily and reliably. Model DPU eliminates the need for cumbersome, unreliable mechanical programming methods – such as dials or switches, and reduces installation and service costs by electronically programming and testing the detector prior to installation. Model HFP-11 is compatible with FS-250 and Fire Finder XLS-series control panels.

Model HFP-11 is [®]Underwriters' Laboratory and [®]Underwriters' Laboratory of Canada listed.

Specifications

Model HFP-11 is a plug-in, two-wire and multi-sensor detector (with both photoelectric and thermal inputs) that is compatible with Fire Finder XLS and FS-250 series of control-panel systems. Each detector consists of a dust-resistant, field-cleanable and photoelectric chamber; a solid state, non-mechanical thermal sensor, and microprocessor-based electronics with a low-profile plastic housing. Model HFP-11 utilizes state-of-the-art ASIC circuitry and surface-mount technology for maximum reliability.

Every Model HFP-11 fire detector is shipped with a protective dust cover. Model HFP-11 utilizes an infrared light emitting diode (IRLED), and light-sensing photodiode. Under normal conditions, light transmitted by the LED is directed away from the photodiode and scattered through the smoke chamber in a controlled pattern.

Specifications – (continued)

The smoke chamber is designed to manage light dissipation and extraneous reflections from dust particles or other non-smoke, airborne contaminants in such a way as to maintain stable, consistent detector operation. When smoke enters the detector chamber, light emitted from the IRLED is scattered by the smoke particles, and is received by the photodiode.

Model HFP-11 also utilizes a modern, accurate and shock-resistant thermistor to sense temperature changes. The 'on-board' *FirePrint*[™] technology allows the detector to first gather smoke and thermal data, and then analyze this information in the detector's 'neural network.' By comparing data received with the common characteristics of fires or fire fingerprints, Model HFP-11 can compare these 'fire prints' to those of deceptive phenomena that cause other detectors to false alarm.

FirePrint

The advanced *FirePrint* technology allows Model HFP-11 to accurately determine a true fire hazard from unthreatening, deceptive phenomena. Further, the advanced *FirePrint* technology will not require a need to use alarm-delaying verification and confirmation techniques, which can increase the probability of losses due to fire. Model HFP-11 provides the highest level of detector intelligence available today with a detector / control panel link that allows the user to program the detector for the specific hazard profile, using a simple software menu selection.

Model HFP-11's *FirePrint* application monitors input from both the photo chamber and the thermal sensor, evaluating this information with sophisticated mathematical formulas or algorithms, comparing this input to characteristics of both threatening fires and deceptive phenomena that would mislead any ordinary detector.

Detectors are optimized by selecting one (1) of the following 11 applications:

- Office / Retail
- Lobby
- Computer room
- Dormitory
- Healthcare
- Parking garage
- Utility / Transformer room
- Hostile environment
- Precious storage
- Air Duct
- Warehouse / Light Manufacturing

The control panel programs Model HFP-11 detector for the protected area without hassle and without confirmation delays. Once optimized for the hazards in the protected area, Model HFP-11 provides the best detection. Should the operator or installer forget to program the detector, Model HFP-11 will revert to a default setting, allowing operation as an office-environment detector.

The *FirePrint* technology was developed over years of research and reviewing the results of over 20 years of fire test data in one of the world's most advanced fire-research centers.

The results of this research are the mathematical models that form the algorithms used in *FirePrint*. No other fire detector has this level of intelligence or this amount of research and development supporting its design. The microprocessor's software can identify and disregard false input caused by radio frequency (RFI) and electromagnetic (EMI) interference, while validating all *Trouble* conditions before annunciating or reporting to the control panel.

Model HFP-11

The Model HFP-11 detector's microprocessor uses an integral EEPROM to store the detector's address and other critical operating parameters, which include the assigned program values for *Alarm* and *Trouble* thresholds.

Communication within the detector, as well as between Model HFP-11 and the control panel, or with Model DPU (field device programmer / test unit), are supervised and safe-guarded against disruption by reliable, microprocessor-based error checking routines.

Additionally, the micro-processor supervises all EEPROM memory locations, and provides a high degree of EEPROM-failure fault tolerance. Model HFP-11 determines its operating status to be *Normal* in *Alarm* or in *Trouble* modes, depending on the difference between the alarm threshold values stored in the detector's memory and the detector's latest analog measurement.

The detector then communicates changes in its status to the control panel. In addition, the FireFinder XLS control panel will sample the value of the analog signal for Model HFP-11 over a period of time, in order to determine if those values indicate excessive buildup in the photo chamber. If such is the case, the FireFinder XLS control panel will indicate the particular detector requires maintenance.

Model HFP-11 is listed as a self-testing device. The visible light emitting diode (LED) for Model HFP-11 flashes 'green' every four (4) seconds to indicate it is communicating with the control panel, as well as to indicate it has passed its internal self-test. Should the detector sense a fault or failure within its systems, the LED will flash 'amber,' and the detector will transmit that data to the control panel.

A quick visual inspection is enough to indicate the condition of the detector at any time. If more detailed information is required, a printed report can be provided from the Fire Finder XLS panel, indicating the status and settings assigned to each individual detector. When Model HFP-11 moves to the *Alarm* mode, it will flash 'red,' and will continue flashing until the system is reset at the control panel. Simultaneously, any user-defined, system-alarm functions programmed into the system are activated.

Specifications – (continued)

Detector sensitivity, calibration and identification are dynamically supervised by the fire-alarm control panel (FACP). Detector sensitivity and pre-alarm levels are a function of the application chosen at the control panel, and are controlled by the panel. If an alternate, non-*FirePrint* mode is selected, then the sensitivity can be changed from the control panel.

All Model HFP-11 detectors use a surface mounting base, Model DB-11, which mounts on a 4-inch octagonal, square or single gang electrical box. The base utilizes screw-clamp contacts for electrical connections and self-wiping contacts for increased reliability. Model DB-11 can be used with the optional Model LK-11 detector locking kit, which contains 50 detector locks and an installation tool to prevent unauthorized removal of the detector head. Model DB-11 has integral decorative plugs to cover the outer mounting screw holes.

Model HFP-11 may be installed on the same initiating circuit with HMS series manual stations, HTRI series interfaces, HCP output control devices, or HZM series of addressable, conventional zone modules. All Model HFP-11 detectors can be cleaned in the field, when required, by simply removing the detector cover and unsnapping the photo chamber. There is also the option of cleaning the interior of the detector with a clean, soft cloth or brush, or by replacing the labyrinth and bug screen included in the detector maintenance kit, Model DMK-11.

All Model HFP-11 detectors are approved for operation within the @UL-specified temperature range of 32 to 100°F (0 to 38°C).

Model DPU

The Device Program / Test Unit accessory is used to program and verify the address of the detector. The technician selects the accessory's program mode, and enters the desired address. Model DPU automatically sets and verifies the address and tests the detector.

Model DPU operates on AC power or rechargeable batteries, providing flexibility and convenience in programming and testing equipment from practically any location.

When in the test mode, Model DPU will perform a series of diagnostic tests without altering the address or other stored data, allowing technicians to determine if the detector is operating properly.

Application Data

Installation of the Model HFP-11 series of fire detectors requires a two-wire circuit. In many retrofit cases, existing wiring may be used. 'T-tapping' is permitted only for Style 4 (Class B) wiring. Model HFP-11 is polarity insensitive, which can greatly reduce installation and debugging time. Model HFP-11 fire detectors can be applied within the maximum 30 foot center spacing (900 sq. ft. areas,) as referenced in NFPA 72. This application guideline is based on ideal conditions, specifically, smooth ceiling surfaces, minimal air movement, and no physical obstructions between potential fire sources and the actual detector. Do not mount detectors in close proximity to ventilation or heating and air conditioning outlets. Exposed joints or beamed ceilings may also affect safe spacing limitations for detectors.

Should questions arise regarding detector placement, observe NFPA 72 guidelines. Good fire-protection system engineering and common sense dictate how and when fire detectors are installed and used. Contact your local Siemens Industry – Fire Safety distributor or sales office whenever you need assistance applying *FirePrint* in unusual applications. Be sure to follow NFPA guidelines and @UL Listed / @ULC Listed installation instructions – included with every Siemens – Fire Safety detector – and local codes as for all fire protection equipment.

Technical Data

Operating Temperatures:	+32°F (0°C) to 100°F (38°C), per @UL 268 / 268A
Humidity:	0-93% Relative Humidity
Non-condensing Maximum Spacing:	30-foot Centers (900 Square Feet), per NFPA 72 Chapter 5 and @ULC-S524

Mounting Diagram

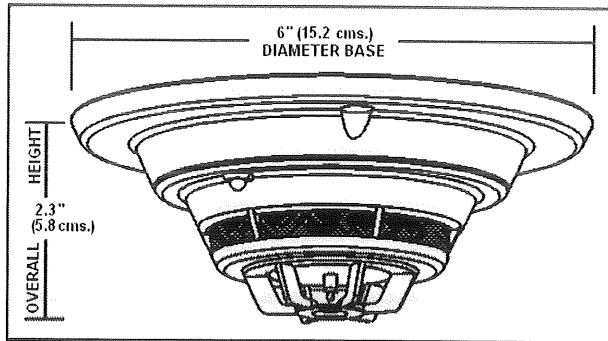

Details for Ordering

Model Number	Part Number	Description
HFP-11	500-033290	Addressable <i>FirePrint</i> TM Fire Detector
DB-11	500-094151	Detector Mounting Base for Series 11
DB-11E	500-094151E	Detector Base {small}
AD2-P	500-649706	Air-Duct Housing
AD2-XHR	500-649708	Air-Duct Housing {with relay}
DB-HR	500-033220	Relay Base for H-Series Intelligent Detectors
ADBH-11	500-033210	Audible Base
RL-HC	500-033230	Remote Alarm Indicator: 4" octagon-box mount, red
RL-HW	500-033310	Remote Alarm Indicator: single-gang box mount, red
LK-11	500-695350	Base Locking Kit for Series 11 Detectors
DMK-11	500-695338	Series 11 Maintenance Kit {replacement labyrinth and bug screen}

In Canada, order:

Model Number	Part Number	Description
DB-11C	500-095687	Detector Mounting Base for Series 11 Detectors (cULC)

Notice: This marketing catalog sheet is not intended to be used for system design or installation purposes. For the most up-to-date information, refer to each product's installation instructions.

FireFinder XLS & FS-250 Control Panels

Intelligent Thermal Detector Model HFPT-11

ARCHITECT AND ENGINEER SPECIFICATIONS

- Microprocessor-based design
- Rate compensated
- Innovative technology provides high-speed, fault-tolerant system / detector communications
- Multi-color detector status LED
- Polarity insensitive utilizing *SureWire*[™] technology
- Detectors are self-testing:
Complete diagnostics every four seconds
- Two-wire operation
- Compatible with DPU device programmer / tester unit
-  UL and  ULC Listed;
FM, CSFM & NYMEA Approved





Product Overview

Model HFPT-11 Intelligent Thermal Detector provides an advanced method of detection, address programming and supervision – combined with sophisticated control-panel communication. Model HFPT-11 uses a state-of-the-art thermistor that provides up to 135°F (57.2°C) rate-compensated temperature.

The Intelligent Thermal Detector is compatible with the Device Program / Test Unit (Model DPU). Model DPU is a compact, portable and menu-driven accessory that makes programming and testing detectors faster, easier and more reliable than other methods.

Model DPU eliminates the need for cumbersome, unreliable mechanical-programming methods, and reduces installation and service costs, via electronically programming addresses and functionally testing the HFPT-11's performance before the detector is installed.

The HFPT-11 thermal detector is  Underwriters' Laboratory and  Underwriters' Laboratory of Canada listed.

Specifications

Model HFPT-11 is a plug-in, (2) two-wire thermal detector, compatible with the FireFinder XLS and FS-250 families of control panels. Each Model HFPT-11 detector has microcomputer-chip technology and highly stable, solid-state electronic circuitry.

Model HFPT-11 detectors utilize a modern, accurate and shock-resistant thermistor to sense temperature changes. This electronic-sensing method virtually eliminates thermal lag associated with mechanical temperature-sensing devices, and provides almost instantaneous temperature information to the control panel. Model HFPT-11, in its default mode, provides up to 135°F (57.2°C) rate-compensated temperature.

FireFinder XLS and FS-250 Control Panels **6302**

Specifications – (continued)

Model HFPT-11 can be programmed from the control panel as a fixed temperature detector without rate-of-rise, at the user's option.

Model HFPT-11 detector's microprocessor uses an integral EEPROM to store the detector's address. Communications within the detector itself and between the HFPT-11 and the control panel, or with Model DPU, are supervised and safeguarded against disruption by reliable, microprocessor based error checking routines. Additionally, the microprocessor supervises all EEPROM memory locations, and provides a high degree of EEPROM failure-fault tolerance.

Model HFPT-11 is listed as a self-testing device. Model HFPT-11's visible light emitting diode (LED) flashes green every four (4) seconds to indicate it is communicating with the control panel, and to show it has passed its internal self-test. Should the detector sense a fault or failure within its systems, the LED will flash amber, and the detector will transmit that information to the control panel.

A quick visual inspection is sufficient to indicate the condition of the detector at any time. If more detailed information is required, a printed report can be provided from the FireFinder XLS panel indicating the status and settings assigned to each individual detector.

When Model HFPT-11 moves to the *alarm* mode, it will flash red and continue flashing until the control panel is reset. At that same time, any user-defined system alarm functions programmed into the system are activated.

A Device Program / Test Unit (Model DPU) is used to program and verify the detector's address. The user selects the program mode to enter the desired address. The DPU Programmer / Test Unit then automatically sets / verifies the address, as well as tests the detector.

Model DPU has rechargeable batteries, which allows a detector's address to be programmed by the user from the most convenient location. The user can also separately test the detector for functionality.

When the user selects the *test* mode, a series of tests are automatically conducted and the user is informed whether the detector has passed or failed.

Model HFPT-11 detector is compatible on the same FireFinder XLS or FS-250 initiating circuit with other H-series detectors, HMS manual stations, HTRI-series addressable interfaces, or HZM-series addressable, conventional zone modules.

Model HFPT-11 detectors use a surface mounting base, (Model DB-11), which mounts on a 4-inch octagonal, square or single gang electrical box. Relay base Model DB-HR mounts to a 4-inch-square-deep electrical box.

Audible base Model ADBH-11 also mounts to a 4-inch-square-deep electrical box. Model DB-11 as well as Models DB-HR and ADBH-11 use screw-clamp terminals for all electrical connections and self-wiping contacts for reliability. The bases also contain a provision for an optional, concealed locking mechanism to prevent unauthorized removal of the detector head, Model LK-11.

Application Data

The FireFinder XLS and FS-250 control panels use loop circuits with each circuit capable of supporting up to 252 Model HFPT-11 intelligent detectors.

Locate Model HFPT-11 on the ceiling, at least 4 inches from the side walls. For an ideal, smooth ceiling condition, place the detectors at a maximum center spacing of 50 feet (2,500 square feet), 25 feet from side walls or room partitions. For FM-approved installations, Model HFPT-11 has a RTI rating of 'FAST.' Use a maximum center spacing of 25 feet (625 square feet), 12.5 feet from side walls or room partitions.

Actual job conditions and sound engineering judgment must determine detector spacing. Consider environmental factors including ambient temperature fluctuation, and the nature of the fire hazard. Room or area configuration and ceiling type (sloped or flat, smooth or beamed) also dictates placement.

Should questions arise regarding detector placement, follow the drawings provided and / or approved by Siemens Industry – Fire Safety Division or by its authorized distributors.

Mounting Diagram

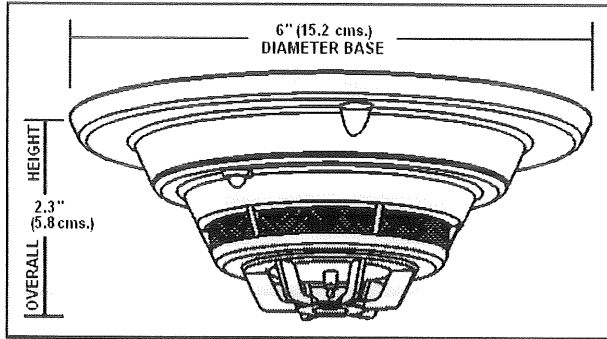

Technical Data

Operating Temperatures:	+32°F (0°C) to 100°F (38°C), per @UL 269 / 268A
Humidity:	0-93% Relative Humidity Non-condensing
Maximum Spacing:	50-foot Centers (2500 Square Feet)
FM-Approved Spacing:	25-foot Centers (625 Square Feet)
Current Draw:	1mA in <i>Alarm</i> or <i>Supervisory</i> mode

Details for Ordering

Model Number	Part Number	Description
HFPT-11	500-033380	Addressable Thermal Fire Detector
DB-11	500-094151	Detector Mounting Base
DB-HR	500-033220	Relay Base
ADBH-11	500-033210	Audible Base
RL-HC	500-033230	Remote (red) alarm indicator-octagon box mount
RL-HW	500-033310	Remote (red) alarm indicator-single gang box mount
LK-11	500-695350	Base Locking Kit for Series 11 detectors

In Canada Order:

Model Number	Part Number	Description
ADBH-11C	500-033210C	Audible Base (ULC)
HFPT-11C	500-033380C	Addressable Thermal Fire Detector (ULC)
DB-11C	500-095687	Detector Mounting Base (ULC)
DB-HR-C	500-033220C	Relay Base (ULC)

This Page Left Intentionally Blank

Notice: This marketing catalog sheet is not intended to be used for system design or installation purposes. For the most up-to-date information, refer to each product's installation instructions.

SIEMENS Industry, Inc.
Building Technologies Division

Fire Safety
8 Fernwood Road
Florham Park, NJ 07932
Tel: (973) 593-2600
FAX: (908) 547-6877
URL: www.SBT.Siemens.com/FIS

SII
Printed in U.S.A.

Fire Safety
2 Kenview Boulevard
Brampton, Ontario
L6T 5E4 / Canada
Tel: (905) 799-9937
FAX: (905) 799-9858

June 2010
Supersedes sheet dated 7/09
(Rev. 2)

SIEMENS

Installation/Wiring Instructions

MODEL DB-11/-11E DETECTOR BASE

Fire Safety

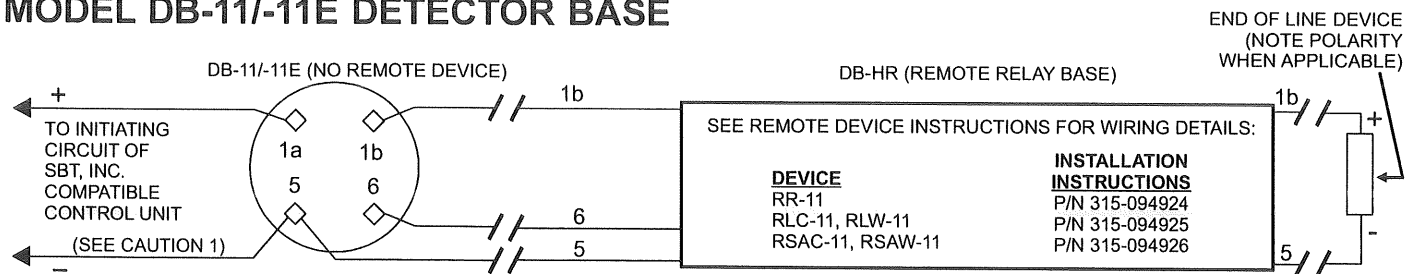

CAUTION:

1. Do not use looped wire under base terminal 5. Break wire run to provide supervision of connection.
2. When a remote relay is used to control a critical system function, the relay and its associated detector and optional module(s) must be the ONLY devices on the initiating circuit.

MULTIPLE REMOTE DEVICES		
<i>If remote devices are supported by the initiating circuit, each detector/base may have up to 2 remote devices with the following configurations and restrictions only:</i>		
Remote Device 1	Remote Device 2	Restrictions
RR-11	RLC-11, RLW-11	See Caution 2
RR-11	RSAC-11, RSAW-11	See Caution 2
RLC-11, RLW-11	RSAC-11, RSAW-11	Wire from base to
RLC-11, RLW-11	RLC-11, RLW-11	RSAC-11/RSAW-11 to RL-11

Figure 1 Wiring Diagram for DB-11/-11E using PE-11, PE-11T, and DT-11 Detectors

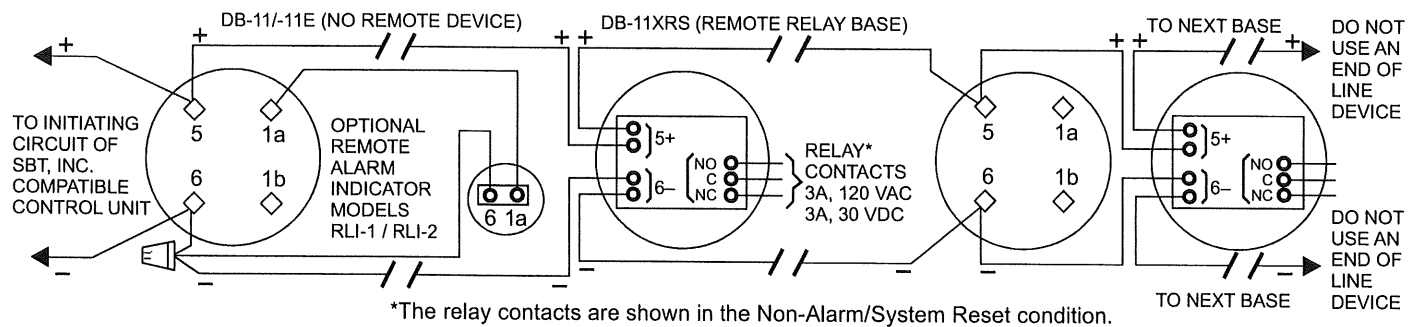
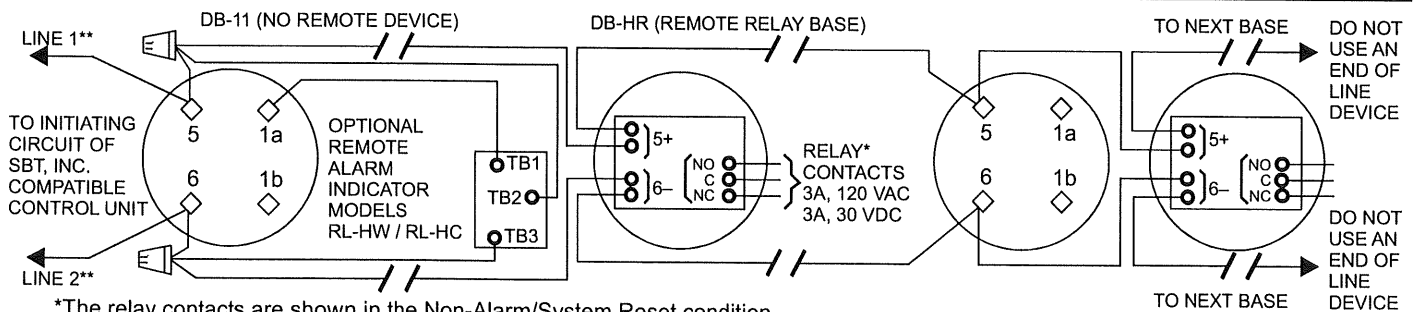

Figure 2 Wiring Diagram for DB-11/-11E using FP-11, FPT-11, FS-DP, FS-DPT, and FS-DT Detectors



*The relay contacts are shown in the Non-Alarm/System Reset condition.

**HFP-11/HFPT-11/HFPO-11/SFP-11/SFPT-11/SFPO-11 is a polarity insensitive detector. Line 1 and Line 2 can be either line of the loop.

NOTE: SFP-11 Series detectors are approved for use in Canada only.

Figure 3 Wiring Diagram for DB-11/-11E using HFP-11 Series and SFP-11 Series Detectors

Siemens Building Technologies, Inc.
8 Fernwood Road
Florham Park, New Jersey 07932

Siemens Building Technologies, Ltd.
2 Kenview Boulevard
Brampton, Ontario, Canada L6T 5E4

Model DB-11/-11E
(P/N 500-094151/500-094151E)

Siemens Building Technologies, Inc.
8 Fernwood Road
Florham Park, New Jersey 07932

Siemens Building Technologies, Ltd.
2 Kenview Boulevard
Brampton, Ontario, Canada L6T 5E4

Model DB-11/-11E
(P/N 500-094151/500-094151E)

DETECTOR AND BASE PLACEMENT

Detector and base locations shall follow the drawings provided or approved by Siemens Building Technologies, Inc. or its authorized distributors. This is extremely important! The detector placements shown on these drawings were chosen after a careful evaluation of all facets of the protected area. When drawings are not available, refer to *Detector Placement* section of detector Installation/Wiring Instructions and to NFPA Standard 72 and CAN/ULC-S524.

BASE WIRING

Siemens Building Technologies, Inc.'s detectors should be interconnected as shown in Figures 1, 2 or 3 and wired to the control panel following the wiring connection drawing installed on the inside face of each control panel cover. NOTE: H Series devices are wired to the DLC or FS-DLC; S Series devices are wired to the FDLC. **Note any limitations on the number of detectors and restrictions on the use of remote devices permitted for each circuit.**

DETECTOR MOUNTING USING THE DB-11/-11E BASE

The detector is provided with a separate base which attaches to a standard 4 inch square, 4 inch octagonal, or single gang electrical box, with the box size and depth required by the NEC for the number and size of conductors used. Wire size: max – 14 AWG, min – 18 AWG.

Refer to Figures 4 and 5, as applicable.

1. Route all wires outward from outlet box.
2. When ALARM LED viewing is critical, position the LED mark in the base in the intended direction.
3. Route wires through the hole in the center of the base and mount base to outlet box. Make connections directly to the base terminals. Refer to Figures 1, 2 and 3 for details.
4. After all bases are installed, check loop continuity. Refer to the System Manual for the loop continuity check procedure. To allow for the continuity check with PE-11, PE-11T or DT-11 detectors, use DBJ-11 Jumper Kit, P/N 500-699167 (between terminals 1a and 1b) to complete the loop. Do not use a jumper for FP-11/HFP-11/FS/SFP-11 family devices.
5. Continuity jumper must be removed from each base prior to installing detector.
6. To insure proper installation of the detector head into the base:
 - a. Route wires away from connector terminals.
 - b. Take up all slack in the outlet box.
 - c. Properly dress and position all wires flat against the base.
 - d. Check that screw terminals are tight.
7. (DB-11 only) Break off the two mounting hole covers, and insert in two outer base mounting holes.

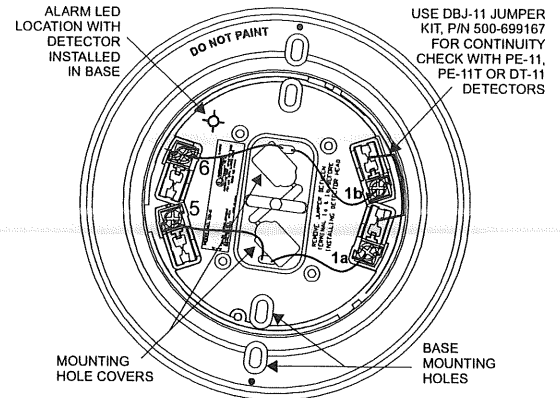

Figure 4
Mounting The DB-11 Base

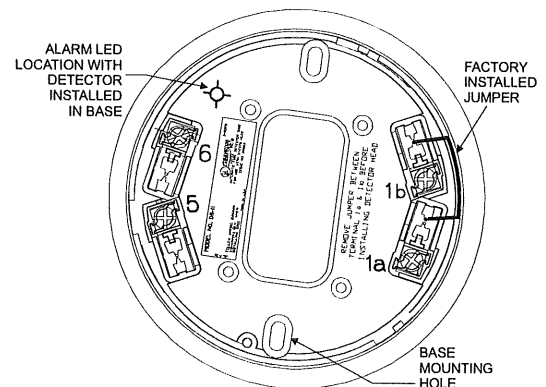

Figure 5
Mounting The DB-11E Base

Conventional Fire Detectors

Thermal Fire Detectors

Models DT-135R, DT-135F, DT-200R and DT-200F

ARCHITECT AND ENGINEER SPECIFICATIONS

-  Listed
- FM Approved

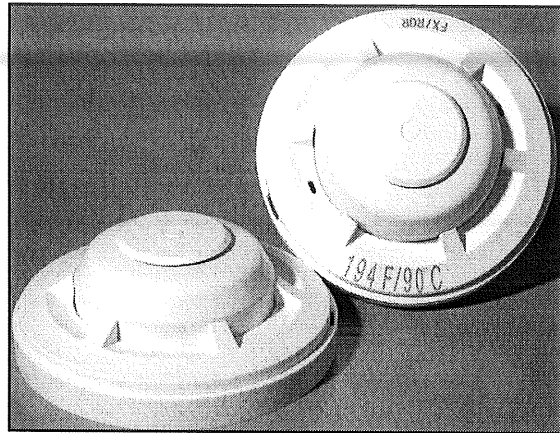

Product Overview

The Siemens Building Technologies — Fire Safety Division Thermal Fire Detectors are fixed temperature or a combination of fixed-temperature / rate-of-rise type. The combination detectors consist of two, independently operated thermal elements. The rate-of-rise element is self-restoring. However, the fixed temperature is of the non-restoring type.

Underwriter's Laboratories, Inc., recommends the combination-type thermal detector be used to protect a maximum of 2,500 square feet (50-foot spacing), and the fixed-temperature type be used to protect a maximum of 625 square feet (25-foot spacing). However, job conditions and engineering judgment often dictate closer spacing to provide faster detection.

The thermal fire detector shall be Fire Safety Model ____ (insert number), and shall operate at a temperature of ____°F (insert temperature). The detectors shall be listed by Underwriters' Laboratories, Inc. and Factory Mutual for use with Siemens Building Technologies, — Fire Safety Division systems.

Specifications

Rate-of-Rise Principle of Operation

The rate-of-rise element consists of an air chamber; a flexible, metal diaphragm and a moisture-proof, trouble-free vent that is carefully calibrated.

It is well known air expands as it is heated, and will contract as it is cooled. For normal, day-to-day fluctuations of temperature, the expansion and contraction of the air within the chamber is automatically compensated by the 'breathing' action of the vent.

However, when a fire occurs, air temperatures rise very rapidly and the air in the chamber expands faster than it can be vented. This creates a pressure which distends the diaphragm and closes electrical contacts.

The rate-of-rise action is not related to any fixed temperature level, but responds with the utmost promptness when the rate of temperature rise exceeds 15°F per minute. If the heat is removed, the air within the chamber contracts and the switch moves to a normally open circuit position.

DT-series Thermal Fire Detectors **6130**

Specifications – (continued)

Fixed Temperature Principle of Operation

In a slow-developing fire, the temperature may not increase rapidly enough to operate a rate-of-rise element. Therefore, a fixed-temperature principle of operation is needed.

The detector utilizes a fixed-temperature element made of fusible alloy and is of the non-restorable type.

The fusible alloy will melt and activate the detector when the surrounding air rises above the preset level of 135°F or 194°F.

The external heat collector drops away when the detector is activated therefore giving a quick visual confirmation that the detector has alarmed.

Installation

Each detector includes a thermoplastic, reversible mounting plate. In one position, it easily attaches to a 4" octagon junction box, 3" octagon box or plaster ring.

In reverse, the plate can be used for open wiring without a junction box. A 1/4" space between detector and mounting surface allows for wire connections. All mounting screws are concealed.

The detector simply attaches to the mounting plate with a push-and-twist motion — no tools are required.

Details for Ordering

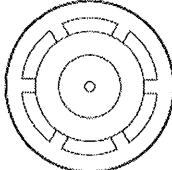
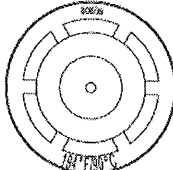
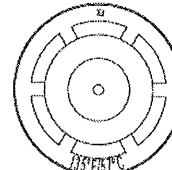
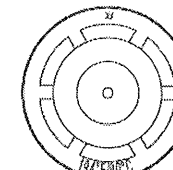
<u>Model Number</u>	<u>DT-135R</u>	<u>DT-200R</u>	<u>DT-135F</u>	<u>DT-200F</u>
<u>Description</u>	Rate-of-rise and fixed temperature 135°F	Rate-of-rise and fixed temperature 194°F	Fixed temperature only, 135°F	Fixed temperature only, 194°F
<u>Applications</u>	Normal temperature fluctuations and ceiling temperatures not exceeding 100°F	Normal temperature fluctuations and ceiling temperatures exceeding 100°F but not 150°F	Unusually violent temperature fluctuations and ceiling temperatures not exceeding 100°F	Unusually violent temperature fluctuations and ceiling temperatures exceeding 100°F but not 150°F
<u>Identification on Heat Collector</u>				

Notice: This marketing data sheet is not intended to be used for system design or installation purposes. For the most up-to-date information, refer to each product's installation instructions.

SIEMENS MSM SERIES

Fire Safety

Metal Manual Fire Alarm Box

ENGINEER AND ARCHITECT SPECIFICATIONS

- Rugged Die-Cast Metal Housing
- Reset Key Matches Control Panel
- Optional Break Glass Operation
- Single-Gang Semi-Flush Mount
- Optional Surface Mount Backbox
- Double-Action Institutional, Weather-Proof and Explosion-Proof Models Available
-  UL Listed, ULC Listed, CSFM, FM and NYMEA Approved

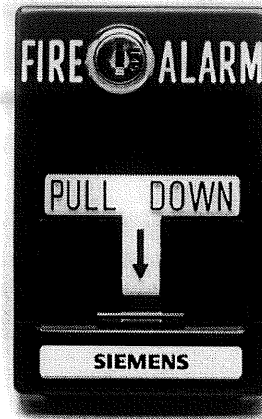

**Standard Model
Or Weatherproof**



Institutional Model

Description

The MSM Series manual stations feature a rugged die-cast metal housing that satisfies both architectural and code requirements for manual fire alarm box initiation devices. The MSM-Series box features keyed reset using the same key as the control panels.

The MSM Series models are low-profile with all surfaces either painted or plated to inhibit corrosion. These boxes have raised lettering and are shipped with two reset keys and a break glass rod (use of rod is optional.) Options include: double action, institutional, weatherproof, and explosion-proof.

These stations are equipped with a S.P.S.T. switch rated at 10amps @ 120 VAC and all connections are made to a terminal block. The explosion-proof model has a D.P.D.T. switch. **Both the weatherproof and explosion-proof models are shipped complete with backbox.** (Backbox is optional with other models, or you can mount to standard single-gang box.)

These models are intended for use with all Siemens Building Technologies, Fire Safety Division conventional zones, but can also be used with addressable zones when used in conjunction with a TRI-Series addressable module.

Dimensions

Station

Width 3.20 in.
 Height 4.75 in.
 Depth 1.20 in. (2.30 in. overall, including back of switch)

Station w/Double Action

Width 3.33 in.
 Height 4.57 in.
 Depth 1.50 in. (2.60 in. overall, including back of switch)

Weatherproof Model

Width 3.20 in.
 Height 4.75 in.
 Depth 2.75 in.

Explosion-proof Model

Width 3.20 in.
 Height 4.75 in. (6.00 in. overall, including mounting ears)
 Depth 3.50 in.

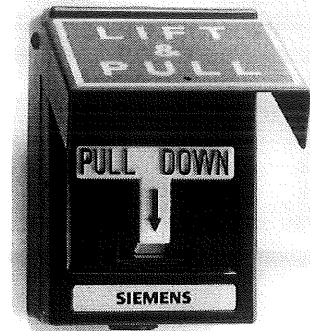

Double Action Model



Explosion-proof Model

Ordering Information

Part Number	Description	Part Number
MSM-K	Manual Station, Metal w/Key	500-698215
MSM-KD	Manual Station, Metal w/Key, Double Action	500-698216
MSM-K-WP	Manual Station, Metal w/Key, Weatherproof	500-698217
MSM-KD-WP	Manual Station, Metal w/Key, Weatherproof, Double Action	500-698218
MSM-EXP	Manual Station, Metal w/Key, Explosion-proof	500-698219
MSM-INST	Manual Station, Metal w/Key, Institutional	500-698220
MSM-BOX	Surface Backbox for MSM-series Manual Stations	500-698221

Installation Instructions

Model HTRI-M

Addressable Interface Module

The **SIEMENS** Model HTRI-M Series Addressable interface module interfaces direct shorting devices to the DLC loop of the FireFinder-XLS System or the FS-DLC loop of the FS-250 System. It is also approved for 1076, Proprietary Burglary.

The HTRI-M can monitor a normally open or closed dry contact and it can report the status of the contact.

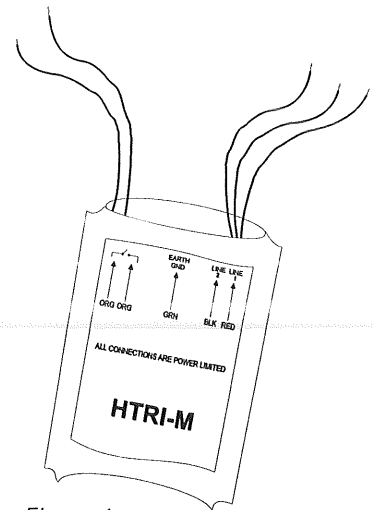

Figure 1
HTRI-M Module

PROGRAMMING

Refer to Figure 1 to locate the red and black DLC/FS-DLC loop circuit wires of the HTRI-M.

Connect the Addressable Loop Driver circuit wires of the HTRI-M to the **SIEMENS** Model DPU Programmer/Tester. Use the cable provided with the Programmer/Tester and the 2 alligator clip to banana plug adapters provided.



To Prevent Damage To The DPU:

DO NOT connect a HTRI-M to the DPU until all field wiring is removed from the red and black DLC/FS-DLC loop circuit wires of the HTRI-M.



Connection from the DPU to the HTRI-M is not polarity sensitive. Refer to Figure 3 for the proper connections to the control panel.

(Refer to Figure 2.) Follow the instructions in the **DPU Programmer/Tester Manual** (P/N 315-033260) to program the desired address into HTRI-M.

Record the device address on the label located on the HTRI-M. The HTRI-M can now be installed and wired to the system.

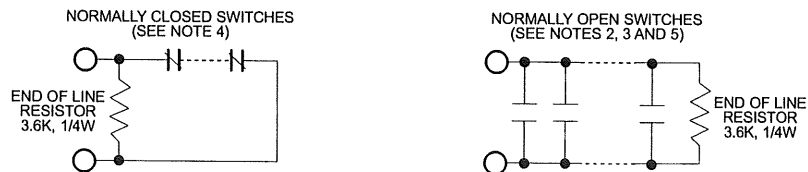

NOTES:

1. There can be any number of normally closed or normally open switches.
2. The end of line resistor must be located at the last switch.
3. Do not wire a normally closed switch across the end of line resistor.
4. Only for use with security and status applications.
5. Do not use N.O. switches for security applications.

Figure 2
Wiring Switches

WIRING

(Refer to Figure 3.) Refer to the wiring diagram and wire the addressable interface module accordingly.



Recommended wire size: 18 AWG minimum
14 AWG maximum

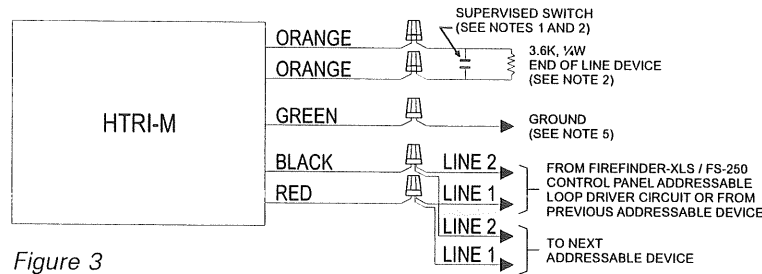

Figure 3
Installing the HTRI-M Wiring

NOTES:

1. All supervised switches must be held closed and/or open for at least a quarter of a second to guarantee detection.
2. End of line device: 3.6K, 1/4W resistor, P/N 140-820185. For Canadian applications, use Model EL-33 with 3.6K, 1/4W resistor.
3. HTRI-M is polarity insensitive. Line 1 and Line 2 can be either line of the loop.
4. The supervised switches have the following ratings:
Voltage maximum: 27 VDC
Current maximum: 3.5mA during polling
Contact resistance maximum: 10 ohms
Maximum cable length: 200 feet (18 AWG)

$C_{\text{Line to line}}$: 0.02uF
Max line size: 14 AWG

$C_{\text{Line to shield}}$: 0.04uF
Min line size: 18 AWG



Ground shield ONLY at the specified location on the Control Panel.

5. The green wire must be connected to earth ground.
 - a. Use wire nuts to pass the shield wire through the electrical box with **NO** connection to the device green wire.
 - b. Use shielded wire to connect the switch wiring.
 - c. Tie the switch wiring shield to earth ground.
6. For proprietary burglary application:
 - a. Use a TSW-1/2 tamper switch to monitor the main enclosure.
 - b. Monitor each HTRI-M related to this application continuously by using a listed motion detector (to prevent tampering).
7. In supervisory: HTRI-M draws 1.5mA
8. All circuits are power limited.

MOUNTING

The SIEMENS Model HTRI-M mounts directly into a single gang switchbox (user supplied)

Connect the appropriate wires using wire nuts. Tuck the HTRI-M module inside the electrical box and dress the wiring as required. (See Figure 4.)

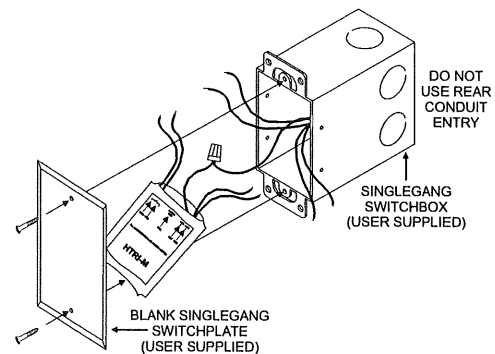



Figure 4
Mounting the HTRI-M

FireFinder XLS and FS-250 Panels

HTRI Series Interface Modules Models HTRI-D, HTRI-R and HTRI-S

ARCHITECT AND ENGINEER SPECIFICATIONS

- Interfacing and supervising normally open (NO) or normally closed (NC) contacts
- Integral SPDT relay on Model HTRI-R (up to 4 amps)
- Dual input on Model HTRI-D, using a single address
- Polarity insensitive with *SureWire™* technology
- Multi-color light-emitting diode (LED) indicates status [green / amber / red]
- Easy front access to programming port and wiring terminals
- Mounts 4-inch square, 2-1/4"-deep box (or double-gang box)
- Dynamic supervision
- Comes with 5-x-5" faceplate
- Two-wire operation
- Model DPU programs and verifies address of the device and tests for proper functionality
- Electronic address programming is easy and dependable
-  UL Listed &  ULC Listed;
FM, CSFM and NYMEA Approved



Product Overview

The Siemens Industry, Inc. — Fire Safety HTRI Series Intelligent interface modules are designed to provide the means of interfacing direct shorting devices to the FireFinder XLS and FS-250 Fire Alarm Control Panel loop circuit.

The HTRI Series modules provide the most advanced method of address programming and supervision on the market — combined with sophisticated control panel communication. Each HTRI Series interface module incorporates a microcomputer chip. The HTRI Series microcomputer chip technology and its sophisticated bi-directional communication capabilities with the control panel, achieve the state of an 'intelligent device.'

Specifications

The HTRI Series intelligent interface modules are available in three (3) models. Models HTRI-S and HTRI-R are designed to monitor a (NO) or (NC) dry contact.

The interface module reports the status of the (NO) or (NC) contact to the control panel. Model HTRI-S can only monitor and report the status of the contact, while Model HTRI-R incorporates an addressable Form C relay.

The Model HTRI-R relay and contact device input are controlled at the same address. For the control panel system, the relay and input contact can be controlled as a separate function. The relay is typically used where control or shunting of external equipment is required.

The Model HTRI-D is a dual-input module that is designed to supervise and monitor two (2) sets of dry contacts. Model HTRI-D only requires one (1) address, but responds independently to each input. Model HTRI-D is ideal for monitoring a water-flow switch and its respective valve tamper switch.

Model HTRI has a multi-color LED that flashes 'green' when operating in *normal*; 'amber' if unit is in *trouble* condition, and 'red' to indicate a change of state.

Specifications (continued)

Model HTRI-D flashes twice — once for each address, and Model HTRI-R LED indicates a change of state in the relay. The device's microcomputer chip has the capacity of storing, in memory, identification information; as well as important operating-status information.

Siemens Industry, Inc., — Fire Safety innovative technology allows all HTRI Series intelligent interface modules to be programmed by using the Device Programming / Test Unit. Model DPU is a compact, portable and menu-driven accessory that makes programming and testing an interface device faster, easier and more dependable than previous methods.

Model DPU eliminates the need for mechanical addressing mechanisms, such as: program jumpers, DIP switches or rotary dials, since Model DPU electronically sets the HTRI Series interface address into the interface microcomputer-chip non-volatile memory. Vibration, corrosion and other conditions that deteriorate mechanical addressing mechanisms are no longer a cause for concern.

The HTRI Series is fitted with screw terminals for connection to an addressable circuit. The HTRI Series is fully compatible on the same FireFinder XLS and FS-250 circuits with all intelligent H-Series detectors, HMS Series addressable manual stations, or any other addressable intelligent modules, such as Model HZM or Model HCP.

All HTRI Series intelligent interface modules are ©UL listed. Environmental operating conditions for all HTRI Series modules are 32°F (°C) to 120°F (49°C) with a relative humidity of no greater than 93%, non-condensing.

Electrical Ratings

Current Draw
(Active or Standby) 1mA

Model HTRI-R Relay Ratings

Resistive: 4 Amps, 125 VAC
4 Amps, 30 VDC

Inductive: 3.5A, 120 VAC (0.6P.F.)
3.0A, 30 VDC (0.6P.F.)
2.0A, 120 VAC (0.4P.F.)
2.0A, 120 VAC (0.35P.F.)
2.0A, 30 VDC (0.35P.F.)

Notice: This marketing catalog sheet is not intended to be used for system design or installation purposes. For the most up-to-date information, refer to each product's installation instructions.

Mounting Diagram

Models HTRI-S, HTRI-D and HTRI-R mount directly into a 4-inch square, 2 ¼-inch deep box or a double-gang box (user supplied). A 5-inch square, off-white faceplate is included with each HTRI Series module.

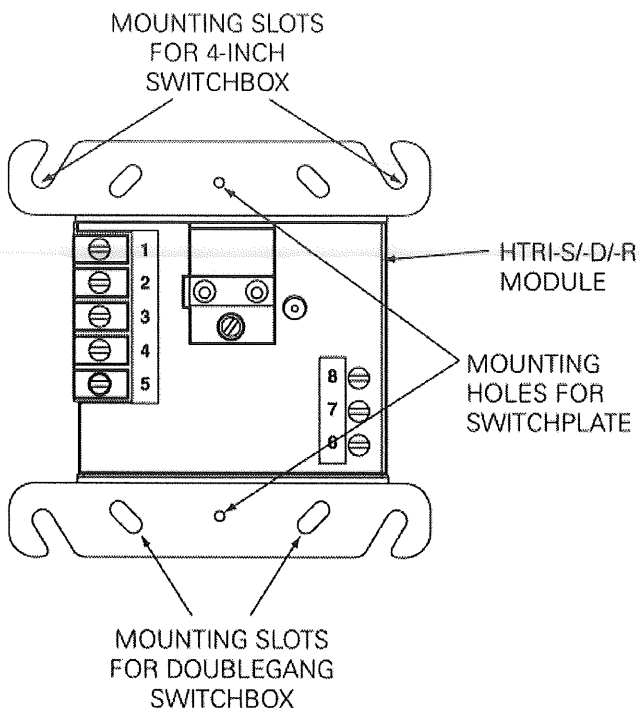

Details for Ordering

Model Number	Part Number	Description	Shipping Wgt.	
			Lb.	Kg.
HTRI-S	500-033370	Single Input	7 oz.	2
HTRI-R	500-033300	Single Input w/Relay	7 oz.	2
HTRI-D	500-033360	Dual Input	7 oz.	2

SIEMENS Industry, Inc.
Building Technologies Division

Fire Safety
8 Fernwood Road
Florham Park, NJ 07932
Tel: (973) 593-2600
FAX: (908) 547-6877
URL: www.SBT.Siemens.com/FIS

Fire Safety
2 Kenview Boulevard
Brampton, Ontario
L6T 5E4 / Canada
Tel: (905) 799-9937
FAX: (905) 799-9858

(SII)
Printed in U.S.A.

June 2010
Supersedes sheet dated 12/04
(Rev. 1)

'08 Series Notification Appliances

ZH & ZR – Strobes, Horns, & Horn / Strobes

Application: Indoor



ZH Series

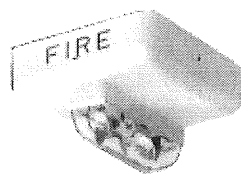
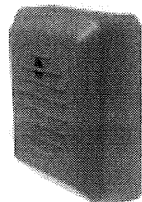

ZR Series

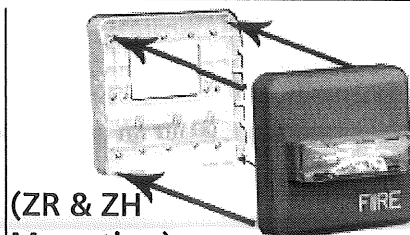

(ZH & ZR Mounting)

Product Overview

- Strobes can be synchronized using the Siemens DSC sync modules, FS-250 panel, XLS panel, or PAD-3 power supply with built-in sync protocol
- Selectable Continuous Horn or Temporal (Code-3) Tones with 90 or 95 dBA selectable setting (ZH)
- Ceiling-mount models feature field-selectable Candela settings of 15/30/75/95cd and 115/177cd
- Wall-mount models feature field-selectable Candela settings of 15/30/75/110cd and 135/185cd
- Base plate is protected by a disposable cover, and the appliances can quickly snap onto the base after the walls are painted
- Strobes produce 1 flash per second
- "Special Applications" listed with Siemens panels
- EZ Mount Universal Mounting Plate (ZBB) – uses single plate for ceiling and wall mount installations
- EZ Mount design – with separate base plate – provides ability to pre-wire the base and test the circuit wiring before the walls are covered
- UL Listed & ULC Listed;
- FM, CSFM & NYMEA Approved
- ADA / NFPA compliant

Specifications

- **General**
 - Audible/Visual notification appliances shall be listed for indoor use only
 - Appliances shall be listed under UL Standard 1971 (Standard for Safety Signaling Devices for Hearing Impaired) and UL Standard 464 (Fire Protective Signaling)
 - Appliances shall use a universal back plate, which shall allow mounting to a single-gang, double-gang, 4-inch-square, 4"-octal, or a 3-1/2"-octal backbox
 - Two-wire appliance wiring shall be capable of directly connecting to the mounting back plate
 - Continuity check shall occur for entire NAC circuit prior to attaching any audible / visual-notification appliances
 - Dust cover shall fit and protect the mounting plate
 - Dust cover shall be easily removed when the appliance is installed over the back plate
 - Removal of an appliance shall result in a trouble condition by the Fire Alarm Control Panel (FACP)

Specifications – (continued)

- **Strobes**

- Strobe appliances shall produce a minimum flash rate of 60 flashes per minute (1 flash per second) over the Regulated Input Voltage Range, and shall incorporate a Xenon flashtube enclosed in a rugged Lexan® lens
- Strobes shall be available with two or four field-selectable settings in one unit, and shall be rated – per @UL 1971 – for up to:
 - 15/30/75/110cd for wall mounted
 - 135/185cd for wall mounted
 - 15/30/75/95cd for ceiling mounted
 - 115/177cd for ceiling mounted
- Strobes shall operate over an extended temperature range of 32°F to 120°F (0°C to 49°C), and be listed for maximum humidity of 95% RH
- Strobe inputs shall be polarized for compatibility with standard reverse-polarity supervision of circuit wiring by a Fire Alarm Control Panel (FACP)

- **Audibles and Audible / Strobe Combinations**

- Horns and horn / strobes shall be listed for Indoor use under @UL Standard 464
- Horns shall be able to produce continuous synchronized output or a temporal code-3 synchronized output
- Horns shall have at least 2 sound-level settings of 90 and 95 dBA

- **Synchronization Modules**

- The strobe portion, when synchronization is required, shall be compatible with DSC sync modules, FS-250 panel, XLS panel, or PAD-3 power supply with built-in sync protocol
- The strobes shall not drift out of synchronization at any time during operation
- Audibles and strobes shall be able to synchronize on a 2-wire circuit with the capability to silence the audible, if required
- Strobes shall revert to a non-synchronized flash-rate, if the sync module or Power Supply should fail to operate (i.e. – contacts remain closed)
- All notification appliances shall be listed for Special Applications:
 - Strobes are designed to flash at 1-flash-per-second minimum over their “Regulated Input Voltage Range”
 - **Note:** NFPA-72 specifies a flash rate of 1-to-2 flashes per second, and ADA Guidelines specify a flash rate of 1-to-3 flashes per second
 - All candela ratings represent minimum-effective Strobe intensity, based on @UL Standard 1971
 - Series ZH Strobe products are listed under @UL Standards 1971 and 464 for indoor use with a temperature range of 32°F to 120°F (0°C to 49°C) and maximum humidity of 93% (± 2%)
 - Series ZH horns are listed under @UL Standard 464 for audible signal appliances (Indoor use only)

Mounting Diagram

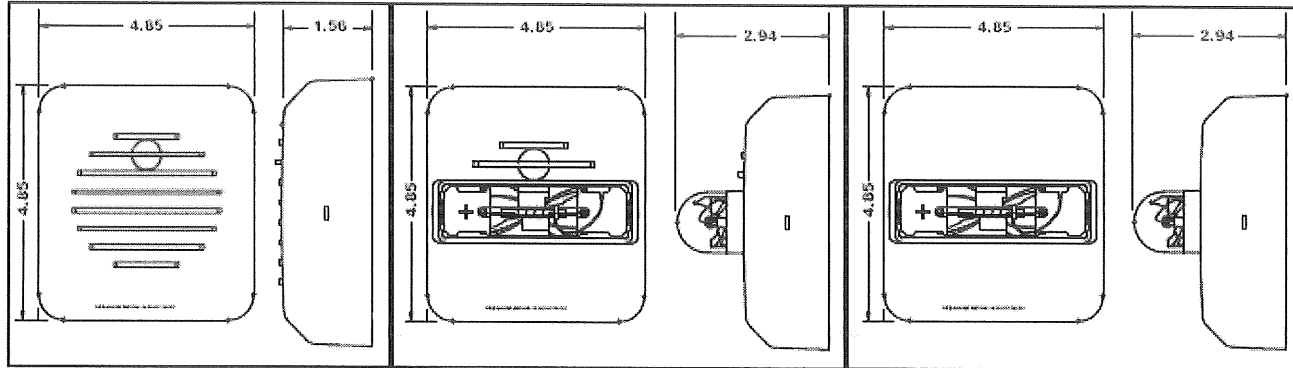

(Shown In Inches)

Mounting Options

Figure 3: Installation

Figure 4: Removal (See step 8 below)

1. Install mounting plate as shown in figure 1 to a single-gang, double-gang, 4" square, 4" octagon, or a 3 1/2" octagon backbox with the provided pan head screws. To remove dust cover, place thumb and index finger on top edges of cover and pull off cover.
2. Connect field wiring per figures 2 and 3.
3. Address wires back into backbox.
4. Place dust cover over mounting plate to protect the terminals while performing wiring continuity check...
5. Remove dust cover before snapping or installing the appliance onto the mounting plate per fig 3.
6. Important: Device only has one mounting orientation. Match the top of the base to the top of the device.
7. If it is desired to further secure the device to the base, then two optional screws are provided. To install these screws punch out the screw holes located at the top and bottom of the device.
8. To remove the appliance, push a small flat-bladed screwdriver into the side opening. The screwdriver must clear the snap release opening by 1/4" to disengage the snap. Do not pry off housing with the screw driver. Apply pressure with screw driver, inserted in either side opening, as shown in Fig 4 to release the housing.

Technical Data

		ZH and ZH-MC Horn Reverberant dBA per UL464 [ZH-MC and ZH at 24V]		
		16.0V	24V	33.0V
Continuous Horn	High	83	87	90
	Low	77	81	83
Code 3 Horn or March Time*	High	79	82	86
	Low	72	76	79

*Available in sync mode only

In (Amps)	ZH Horn Current Draw	
	Horn Setting	16-33 Volts
DC	High*	0.044
	Low*	0.018
FWR	High*	0.075
	Low*	0.045

*Current Draw is the same for the Continuous Horn, Code 3 Horn and March Time Settings.

Technical Data – (continued)

UL Listed Models and Ratings					
Models*	Operating Voltage (Special Application) [Per UL 1971] (VDC/VRMS)	Voltage Range [Per ULC-S526-02] (VDC/VRMS)	Horn	Mounting	Strobe Candela (cd)
ZR-MC	16.0-33.0	20.0-31.0	—	Wall	15/30/75/110
ZR-HMC	16.0-33.0	20.0-31.0	—	Wall	135/185
ZR-MC-C	16.0-33.0	20.0-31.0	—	Ceiling	15/30/75/95
ZR-HMC-C	16.0-33.0	20.0-31.0	—	Ceiling	115/177
ZH-MC	16.0-33.0	20.0-31.0	X	Wall	15/30/75/110
ZH-HMC	16.0-33.0	20.0-31.0	X	Wall	135/185
ZH-MC-C	16.0-33.0	20.0-31.0	X	Ceiling	15/30/75/95
ZH-HMC-C	16.0-33.0	20.0-31.0	X	Ceiling	115/177
ZH	16.0-33.0	20.0-31.0	X	Wall or Ceiling	—

* Available in red and white

UL Current Ratings (ZR Strobe Only) Maximum RMS Current (AMPS)													
		MC				HMC		MC-C				HMC-C	
		15cd	30cd	75cd	110cd	135cd	185cd	15cd	30cd	75cd	95cd	115cd	177cd
DC	16-33 VDC	0.064	0.098	0.175	0.233	0.318	0.445	0.069	0.111	0.200	0.264	0.318	0.445
FWR	16-33 VRMS	0.108	0.164	0.268	0.368	0.482	0.684	0.117	0.180	0.297	0.398	0.482	0.684

UL Current Ratings ZH Horn/Strobe Maximum RMS Current (AMPS)														
		Horn Setting	MC				HMC		MC-C				HMC-C	
			15cd	30cd	75cd	110cd	135cd	185cd	15cd	30cd	75cd	95cd	115cd	177cd
DC	16-33 VDC	High*	0.078	0.113	0.195	0.259	0.371	0.506	0.087	0.131	0.222	0.292	0.371	0.506
		Low*	0.070	0.107	0.188	0.246	0.324	0.455	0.075	0.121	0.213	0.277	0.324	0.455
FWR	16-33 VRMS	High*	0.141	0.200	0.302	0.406	0.521	0.722	0.149	0.216	0.331	0.436	0.521	0.722
		Low*	0.123	0.179	0.290	0.391	0.497	0.699	0.131	0.195	0.319	0.421	0.497	0.699

* Current Draw is the same for the Continuous Horn; Code 3 Horn and March Time Settings

Details for Ordering – (Including Mounting Options & Agency Approvals)

Agency Approvals

Model Number	Part Number	Description	Mounting Options*	Agency Approvals			
				UL	ULC	FM	CSFM
ZH-R	500-636159	Z Horn: Red	B,D,E,F	X	X	X	X
ZH-W	500-636160	Z Horn: White	B,D,E,F	X	X	X	X
ZH-MC-R	500-636161	Z Horn: Multi Candela (Wall), Red	B,D,E,F	X	X	X	X
ZH-MC-W	500-636162	Z Horn: Multi Candela (Wall), White	B,D,E,F	X	X	X	X
ZH-HMC-R	500-636163	Z Horn: Hi Multi Candela (Wall), Red	B,D,E,F	X	X	X	X
ZH-HMC-W	500-636164	Z Horn: Hi Multi Candela (Wall), White	B,D,E,F	X	X	X	X
ZH-MC-CR	500-636165	Z Horn: Multi Candela (Ceiling), Red	B,D,E,F	X	X	X	X
ZH-MC-CW	500-636166	Z Horn: Multi Candela (Ceiling), White	B,D,E,F	X	X	X	X
ZH-HMC-CR	500-636167	Z Horn: Hi Multi Candela (Ceiling), Red	B,D,E,F	X	X	X	X
ZH-HMC-CW	500-636168	Z Horn: Hi Multi Candela (Ceiling), White	B,D,E,F	X	X	X	X
ZR-MC-R	500-636169	Z Strobe: Multi Candela (Wall), Red	B,D,E,F	X	X	X	X
ZR-MC-W	500-636170	Z Strobe: Multi Candela (Wall), White	B,D,E,F	X	X	X	X
ZR-HMC-R	500-636171	Z Strobe: Hi Multi-Candela (Wall), Red	B,D,E,F	X	X	X	X
ZR-HMC-W	500-636172	Z Strobe: Hi Multi-Candela (Wall), White	B,D,E,F	X	X	X	X
ZR-MC-CR	500-636173	Z Strobe: Multi Candela (Ceiling), Red	B,D,E,F	X	X	X	X
ZR-MC-CW	500-636174	Z Strobe: Multi Candela (Ceiling), White	B,D,E,F	X	X	X	X
ZRS-HMC-CR	500-636175	Z Strobe: Hi Multi Candela (Ceiling), Red	B,D,E,F	X	X	X	X
ZRS-HMC-CW	500-636176	Z Strobe: Hi Multi Candela (Ceiling), White	B,D,E,F	X	X	X	X
ZBB-R	500-636193	Accessory – (Includes base, dust cover, mounting screws and installation sheet)					
ZBB-W	500-636194	Accessory – (Includes base, dust cover, mounting screws and installation sheet)					

X = listed / approved

* = Refer to catalog sheet #: 2585 for detailed mounting options

Notice: This marketing catalog sheet is not intended to be used for system design or installation purposes. For the most up-to-date information, refer to each product's installation instructions.

GS3055-I CF

GSM-GPRS INTERFACE

Installation Manual



WARNING: This manual contains information on limitations regarding product use and function and information on the limitations as to liability of the manufacturer.

Table of Contents

Introduction	1
Features	1
Technical Specifications	1
Description	2
Approvals Information	2
Identification of Parts	3
Installation of GS3055-I CF	4
GS3055-I CF Connections Descriptions	5
Status LEDs	6
Operating Modes	6
Simulated Land Line (Dialler) Mode	6
Inputs Activation Mode	7
Outputs	7
Contact ID Events Description	7
Appendix - Wiring diagrams	8

Introduction

The GS3055-I CF is a complete UL commercial fire and/or burglary solution for a wireless communicator that can send status change events information over the GSM GPRS Network from the Alarm Control Panel at the protected premises to a supervising station. The device is compatible with UL listed alarm receivers Models SG-SYSTEM III (using SG-DRL3-IP line card), SG-SYSTEM II and SG-SYSTEM I.

Features

- Compatible with listed alarm control panels that have an integrated DACT and support a 4 or 10-digit Contact ID Communication Format
- Complete solution CF Kit includes tamper protection output, listed power supply and battery standby capability for 24h,
- Telephone line Overvoltage protection and monitoring with automatic switch over to the GSM network communication path when a phone line trouble condition exists,
- GSM network connection and signal strength indicator,
- 4 Input lines and 4 Open collector outputs available for interfacing with the alarm control panel
- Internet/Intranet IP communication over the GSM GPRS network.

Technical Specifications

Input Voltage:	120V/60HZ/0.3A
Standby Voltage:	12V/7Ah
Standby Time:	24h (NSC) plus 5 minutes alarm
Standby Battery:	Sealed, rechargeable type, replace every 3-5 years
Low Battery Trouble Indication Threshold:	11.5Vdc
Battery Deep Discharge Protection (cut-off)	9.5Vdc
Recharging Current:	700mA (max.)
Inputs:	12V/1mA, 4 available, supervised
Outputs:	12V/50mA, 4 open-collector available, not supervised
Internal Event Buffer:	256 events (not viewable)
Loop Resistance:	1k Ohm (max. loop resistance between devices connected in series on T1/R1)
Operating Frequency:	850/1900MHz (Dual Band GSM Radio)
Antenna Gain:	1.5dB (product shall be used only with the supplied antenna)
Operating temperature:	0°C - 49°C (32°F - 120°F)
Humidity:	93%RH maximum (non-condensing)
Metal enclosure:	red painted, with hardwired transformer and high voltage connection box included
Dimensions:	290mm x 254mm x 75mm (11-1/2" x 10" x 3")
Weight:	5.8Kg (12.8 lbs) (including standby battery)

This equipment, GS3055-I CF, is fixed and shall be installed by Service Persons only (Service Person is defined as a person having the appropriate technical training and experience necessary to be aware of hazards to which that person may be exposed in performing a task and of measures to minimize the risks to that person or other persons) according to the local rules and regulations. It shall be installed and used within an environment that provides the pollution degree max 2, over voltages category II, in non-hazardous, indoor locations only. This manual shall be used with the Installation Manual of the alarm control panel. All instructions specified within that manual must be observed. WARNING: The metal shell of the RS232 connector is not earthed! Before connecting to this port, check the metal shell for HAZARDOUS VOLTAGES!

Description

The GS3055-I CF has the capability of communicating alarm signals via the GPRS data network. The capability enables a fast reliable path to central stations equipped with a Sur-Gard System III, System II, or SG-SYSTEM I receiver. By connecting a GS3055-I CF to a control panel's standard PSTN interface, telephone based Contact ID signals are decoded and seamlessly routed through the GPRS network to any of the compatible receiver options.

The performance of the GS3055-I CF depends greatly on GSM Network coverage, therefore, it should not be mounted without first performing placement tests to determine the best location for reception (minimum one green LED is ON). Optional antenna kits are available.

The GS3055-I CF requires enrollment with CONNECT 24 to operate. Dealer application forms and additional information on the CONNECT 24 Voice Response Unit (VRU) and web user-interface can be found at www.connect24.com or at the following telephone numbers:

USA 1-888-251-7458

CANADA 1-888-955-5583

Approvals Information

For Commercial Fire Monitoring Installations:

The GS3055-ICF can be used in the following configurations:

1. Standalone communicator, single communication technology - 5 minutes supervision (Heartbeat sent to supervising station every 5 minutes or less)
2. Back-up communicator line for a DACT (no heartbeat sent).
 - Alarm signals must be sent first over the primary communication path (DACT) and if this is known to have failed, over the secondary communication paths (Other transmission technologies)
 - Primary: Compatible Listed control unit's land line to central station (primary).
 - Secondary: GS3055-I CF transmission through GSM-GPRS network to central station.
 - Every 24 hours a check-in signal must be sent to the central station over the primary dialer. The GS3055-I CF sends a heartbeat test transmission to the supervising station every 24hours.
 - Each communication path shall be monitored for integrity (DACT shall have line monitoring enabled and GS3055-ICF shall have cellular connection supervision enabled).

For UL Central Station Commercial Burglary Installations:

The GS3055-I CF can be used in the following configurations:

1. Standalone communicator, single line-200 second supervision (Heartbeat sent to supervising station every 135s, alarm receiver supervision window set to 200s).
2. Primary communicator line for a DACT (Heartbeat sent to supervising station every 135s, alarm receiver supervision window set to 200s).
3. Back-up communicator line for a DACT (no heartbeat sent).

The GS3055-ICF is designed to work with the Contact ID communication format as described in SIA DC-05 Standard. Before completing the field installation of the alarm monitoring system please ensure communication with the supervising central station is successful by sending several events and getting confirmation that they have been received.

Identification of Parts

The numbers in square brackets [] in this manual refer to the main parts of the GS3055-I CF (see Fig. 1 below) described in this section.

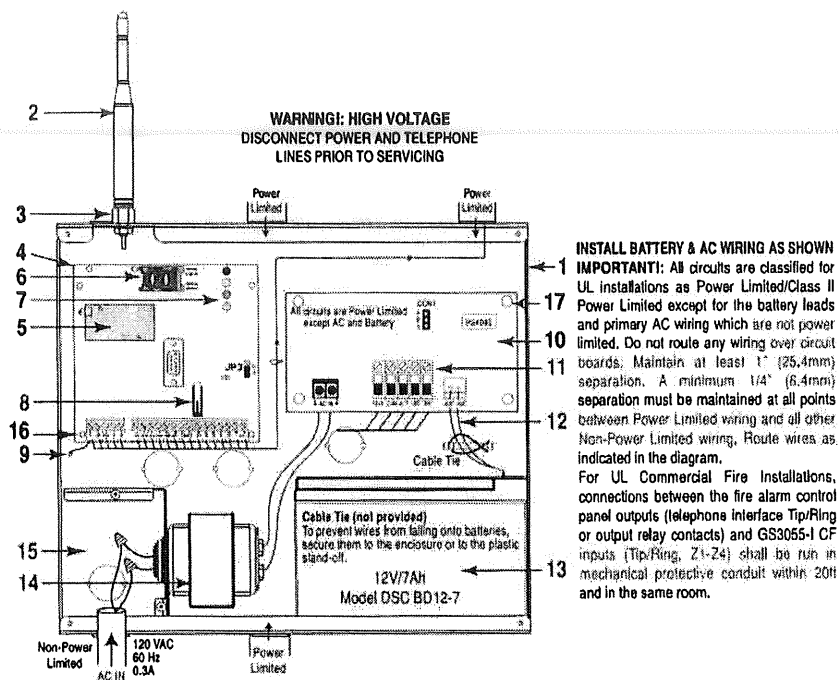

NOTES: Connection of metal-clad cable, conduit, metal raceway or the like is permitted as a means for grounding. Use the supplied starwashers to secure the mains connection box cover and the front cover of the enclosure.

PARTS	
1	GS3055-I CF Metal Enclosure
2	External Antenna (supplied)
3	Antenna mounting hardware
4	GS3055-I CF PCB Assembly
5	GSM Radio with Connector for Antenna
6	SIM Card Socket
7	Status LEDs
8	Tamper Switch
9	GS3055-I CF Connections (see Fig. 2 for details)
10	Power Supply PCB Assembly
11	Power Supply Connections (see Fig. 3 for details)
12	Standby Battery Leads
13	Standby Battery 12V/7Ah
14	Transformer 16.5V/37VA
15	Mains Connections Box with Cover

Figure 1 - Parts

Installation of GS3055-I CF

CONNECT 24 Enrollment Information

Only authorized dealers can enroll a GS3055-I CF with CONNECT 24. Dealer application forms and additional information on the CONNECT 24 Voice Response Unit can be found at the CONNECT 24 web site www.connect24.com. Please contact CONNECT 24 at the number below for assistance:

USA 1-888-251-7458

CANADA 1-888-955-5583

NOTE: Steps 1 and 2 should be completed before powering the GS3055-I CF unit.

STEP 1 - Activate Your SIM Card

Your SIM card must be activated with Connect 24 prior to use. Please call the Voice Response Unit (VRU) at least 24 hours prior to installation at 1-866-910-3865.

STEP 2 - Initialize the GS3055-I CF with Connect 24

Call the VRU at the toll-free number. Follow the voice prompts and enter in your profile number, installer ID number, installer PIN number and central station number. Ensure all information is available before calling the VRU. All this information can be found in your VRU Enrollment Package.

NOTE: For UL Commercial Fire listed products the supervision heartbeat shall be enabled.

STEP 3 - Determine Best Signal Location

1. Remove the screws and the front cover of the GS3055-I CF metal enclosure [1].
2. Fit the antenna [2] (ensure that the bolt [3] is fastened tightly).
3. Connect the antenna to the GSM Radio [5] and ensure the connector is secure.

NOTE: Before inserting or removing the SIM card, please ensure the unit is powered down.

4. Ensure the SIM card is placed in its socket [6]
5. Power up the GS3055-I CF module [4] and check signal strength on status LEDs [7].
 - Use a DC power source rated 12V/0.7A connected to +/- 12V terminals [9]
 - Allow unit to power up
 - The green LEDs will indicate the signal strength. The bottom green LED must be ON for the location to be acceptable. Please refer to the "Status LEDs" section for more information.
6. Power down the GS3055-I CF by removing the DC power source.

STEP 4 - Connect the GS3055-I CF

1. Using the cabinet, mark the 4 screw locations then drill the anchor screw holes.

NOTE: Check for cable conduits and water pipes before drilling.

2. Using anchor screws (not included), mount the cabinet to the wall.
3. Run the cables, then pull them through the cable entry or the knockouts provided.
4. Complete the connections to the terminal blocks [9], [11]. **Ensure power and Telco circuit connections are made only after the cabinet has been secured to the building or structure and has been connected to the protective earth ground.** Descriptions of the terminals can be found in the "Connecting the GS3055-I CF" section.
5. Using the 4 screws, reattach the front cover securely to the cabinet [1].

NOTE: Please refer to Figures 2 and 3 at the end of this manual for wiring diagrams.

GS3055-I CF Connections Descriptions

GS3055-I CF Module

⊥ (1) Earth Ground - This terminal must be connected to the Mains Earth, in order to comply with the Telecommunications Network Safety Standards (Overvoltage Protection Requirements).

TIP (2) / RNG (3) External telephone line - These terminals must be connected directly to the incoming telephone line.

T1 (4) / R1 (5) Internal telephone line - These terminals must be connected to the TIP and RING of the control panel.

COM(6,14) Common - This terminal is connected internally to Power Ground.

PGM1 (7), PGM2 (8), PGM3 (9), PGM4 (10) Programmable type open-collector outputs. These outputs can be activated by programmed events, refer to "Outputs" section for details. The maximum current sink of each output must not exceed 50mA. PGM1, PGM2 and PGM3 are active low and PGM4 is active high.

AUX+ (11) Auxiliary 12V Output - Special applications output, power-limited, 200mA PTC Protected. This terminal is used in conjunction with the PGM outputs to activate a supervision relay. Recommended relay: DSC Model RM-2.

NOTE: Current drawn from this terminal is directly drawn from the power supply.

Tamper (12-13) - These terminals are connected in series to the Tamper microswitch [8]. They will be closed when the cabinet is properly closed, and will open when the front cover is removed.

Z1-Z4 (15-16-17-18) Inputs - These terminals are set up to trigger events. Refer to "Inputs Activation Mode" section for details.

+12V (19), -12V (20) Device Power Supply - These terminals must be connected to the output of the power supply [10]. When the connections are completed, connect the Red and Black wires [12] to a 12V, 7Ah battery [13].

Power Supply Module

AC - Supervised input, connect the secondary of the transformer to these terminals. Connect the primary of the transformer to a dedicated electrical circuit.

+12V/COM - Special application output circuit, power limited, connect to GS3055-I CF power input circuit. Connect the +12V output to +12V input on the GS3055-I CF module and the COM output to the -12V input on the GS3055-I CF module.

ACT (AC Trouble) - This open collector output activates when an AC Trouble is detected: Rated 50mA.

NOTE: AC Trouble output shall be connected to an input on the alarm control panel that provides immediate local annunciation and delayed remote transmission for 1 to 3 hours. If such input is not able to provide the delay for AC loss transmission, input 1 of the GS3055-I CF can be used. When Input 1 is triggered, the GS3055-I CF will immediately annunciate an AC trouble by flashing the RED status LED 9 times, and will delay the AC loss event transmission by 2 hours.

LBT (Battery Trouble) - This open collector output activates when a Battery Trouble condition is detected: Rated 50mA.

TEST (Charger Trouble) - This open collector output activates when the charging circuit is in a trouble condition: Rated 50mA.

These outputs shall be connected to zone inputs of an alarm control panel in order to provide the required trouble supervision (visual and audible indication required at the control panel). The outputs are active low (switched to ground) and can be connected to a control panel directly or by using a listed supervision relay (suggested model: DSC, RM-2 Relay).

+BAT/-BAT - This connector is used to connect the standby battery, non-power limited. Use single lead battery wire assembly provided.

NOTE: When disposing of batteries, follow the instructions and and precautions printed on the batteries, and contact your municipal offices for information on the disposal of used batteries.

Status LEDs

The GS3055-I CF has 4 LEDs used for local indication of module functionality, status (trouble conditions) and receiving signal strength.

▲ RED — This LED is Normally OFF, it will blink in the event of trouble. This LED will switch ON within 3 minutes in the event of GSM Radio [5] trouble, or when the GSM Network is unavailable (NO SERVICE). If this LED blinks, the following list will indicate the specific trouble based on the number of blinks, by priority. On power-up, the GS3055-I CF will check for trouble conditions to be restored in the order listed below. It will indicate the status of the highest priority, unrestored trouble condition with the corresponding number of flashes of the RED LED.

When the highest priority trouble condition has been cleared, the next highest priority trouble condition will be displayed.

- 1 flash - Power Trouble (*Low input voltage*)
- 2 flashes - Radio/SIM Failure (*Check SIM Card connection*)
- 3 flashes - GSM Network Problem (*SIM Card not active, poor signal strength, antenna not connected*)
- 4 flashes - Insufficient Signal Strength (*Poor location*)
- 5 flashes - Connect 24 Configuration SMS Failure (*Improper VRU programming*)

When the configuration is ready, remove power for 2-3 seconds to allow the unit to restart and recheck status.

- 6 flashes - Receiver Not Initializing (*Improper VRU programming*)
- 8 flashes - Primary Receiver absent (*Receiver not acknowledging*)
- 9 flashes - AC Trouble (Input 1) triggered.
- Off - No Troubles

📶 YELLOW — This LED will switch ON when the interface switches to the GSM Network (due to land line trouble). This LED can also blink quickly once (GPRS TX) or twice (GPRS RX).

NOTE: The top two LEDs will blink during the initialization activation stages.

↕ GREEN (Top) — When this LED is ON, the reception is optimal. This LED will switch ON only when the other GREEN LED is ON.

↕ GREEN (Bottom) — If this LED is OFF and the RED LED is ON, the GSM Network service is unavailable (NO SERVICE). This LED will Blink when the GSM Network reception is bad. If this LED is ON, the GS3055-I CF will be able to communicate to the GSM network.

Operating Modes

Simulated Land Line (Dialler) Mode

The simulated land line mode provides the alarm control panel (with dialler interface) with a backup communication path in the event of PSTN line trouble. If the voltage on the land line terminals (TIP/RNG) drops below 4V for a period of between 10 to 45 seconds (depending on the device connected to the T1/R1 terminals), the GS3055-I CF will switch the connected alarm control panel to the GSM Network for approximately 30-40 seconds. At the end of this interval, it will check the land line.

- If the land line is restored, it will switch the connected alarm control panel back to the land line;
- If the land line is still down, it will continue to simulate the land line until it is restored. The GS3055-I CF will not switch during ongoing calls.

In this mode the communication of an event follows the sequence below:

- When an event is triggered, the alarm control panel dialler goes off-hook
- The GS3055-I CF will assert dial tone
- The Alarm Control Panel dials the number of the central station. Ensure the alarm control panel inserts a 1-second pause (minimum), or has dial tone search enabled before dialing the number
- The GS3055-I CF detects the DTMF dialing and stops the dial tone

NOTE: The GS3055-I CF is unable to decode pulse dialing.

- The GS3055-I CF will send the required Contact ID dual tone handshake to the alarm control panel
- After receiving the handshake, the alarm control panel transmits the event alarm message in Contact ID format
- The GS3055-I CF decodes and transforms the Contact ID digits into an IP packet and sends it to the Supervising Station Receiver over the GSM GPRS network

- The receiver acknowledges the received event and sends a command to the GS3055-I CF to generate the corresponding 1400Hz kiss-off signal for 800ms minimum
- After the GS3055-I CF generates the kiss-off, the alarm control panel goes on-hook if no more events need to be sent, or it can send the next event

Inputs Activation Mode

The GS3055-I CF also has 4 inputs that can be used to trigger specific event transmissions. The events associated with these inputs will be transmitted using Contact ID Communication Format. The default settings for these inputs (as they should be correlated at the supervising station) are:

INPUT 1 - AC LOSS INPUT 3 - FIRE ALARM
 INPUT 2 - FIRE SUPERVISORY INPUT 4 - TROUBLE

For UL Commercial Fire Listing, the GS3055-I CF operating in this mode shall be used in conjunction with a listed primary communication method.

These inputs are normally open type and will activate when a short condition is detected between the terminal and the COM. Refer to the GS3055-I CF Wiring Diagram (Figure 2) at the back of this manual.

NOTE: When the GS3055-I CF is configured in Land Line Mode, these inputs should be restricted to monitoring of trouble conditions.

NOTE: For UL listing, connections between alarm panel outputs and GS3055-I CF inputs shall be run in mechanical protective conduit within 20ft and in the same room. To reduce interference with the antenna, it is recommended that metal conduit is not connected to the knock-outs on the top of the cabinet.

Outputs

The GS3055-I CF has 4 open collector outputs, switched to ground, capable of a maximum of 50mA. Internal events on the GS3055-I CF can trigger the outputs to turn on an LED or activate an input on the alarm control panel. The default settings are as follows:

OUTPUT 1 - Land Line Trouble: Output is normally high and will switch to ground when the telephone line is down.

OUTPUT 2 - GSM Module or Network Trouble: Output is normally high and will switch to ground when the GS3055-I CF cannot connect or communicate to the GSM network.

OUTPUT 3 - Activation: Output is normally high and will switch to ground during activation.

OUTPUT 4 - General Module Trouble: Output is normally low and will switch to high when any of the previous troubles occur and/or a Failure to Communicate (FTC) trouble is detected.

NOTE: Once an output has been activated automatically, it will not restore its state until all the causes of activation are cleared.

Contact ID Events Description

Event Codes

Input 1 Activation:	E301 AC LOSS ZONE	991
Input 1 Restoral:	R301 AC LOSS ZONE	991
Input 2 Activation:	E200 Fire Supervisory ZONE	992
Input 2 Restoral:	R200 Fire Supervisory ZONE	992
Input 3 Activation:	E110 FIRE ZONE	993
Input 3 Restoral:	R110 FIRE ZONE	993
Input 4 Activation:	E300 System Trouble ZONE	994
Input 4 Restoral:	R300 System Trouble ZONE	994
PSTN Line Down:	E351 TELCO 1 FAULT	000
PSTN Line Restoral:	R351 TELCO 1 FAULT	000
Periodic Report:	E603 Periodic RF Xmission	000
Periodic report with off-normal condition	E608 Periodic Test Xmission with System Trouble Present	000
GSM UNIT ACTIVATION:	R552 Radio Xmitter Disabled	000
GSM INTERNAL BUFFER FULL:	E624 EVENT LOG OVERFLOW	000
FTC RESTORAL:	R354 FAILURE TO COMMUNICATE	000

NOTE: The GS3055-I CF does not support local or remote programming. Upon activation through Connect 24 the product will operate as described in the previous sections of this manual.

APPENDIX - Wiring diagrams

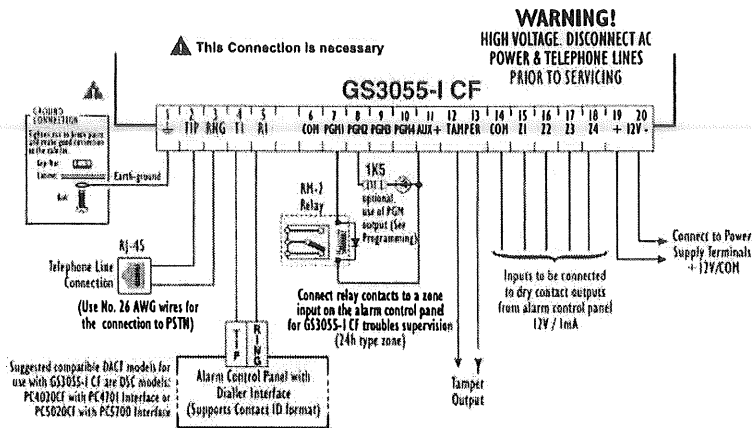

WARNING: Incorrect connections may result in PTC failure or improper operation. Inspect wiring and ensure connections are correct before applying power. All circuits are classified for UL installations as Power Limited/Class II Power Limited except for the battery leads which are not power limited. Do not route any wiring over circuit boards. Maintain at least 1" (25.4mm) separation. A minimum 1/4" (6.4mm) separation must be maintained at all points between Power Limited wiring and all other Non-Power Limited wiring. Route wires as indicated in the diagram.

Fig. 2 - GS3055-I CF Module Wiring Diagram

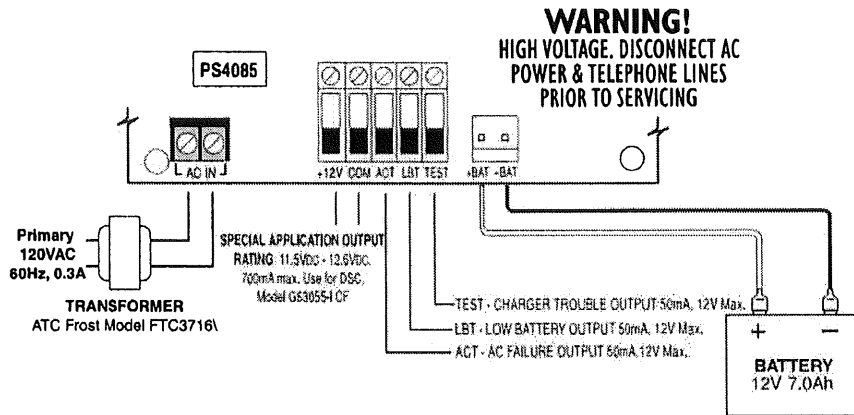
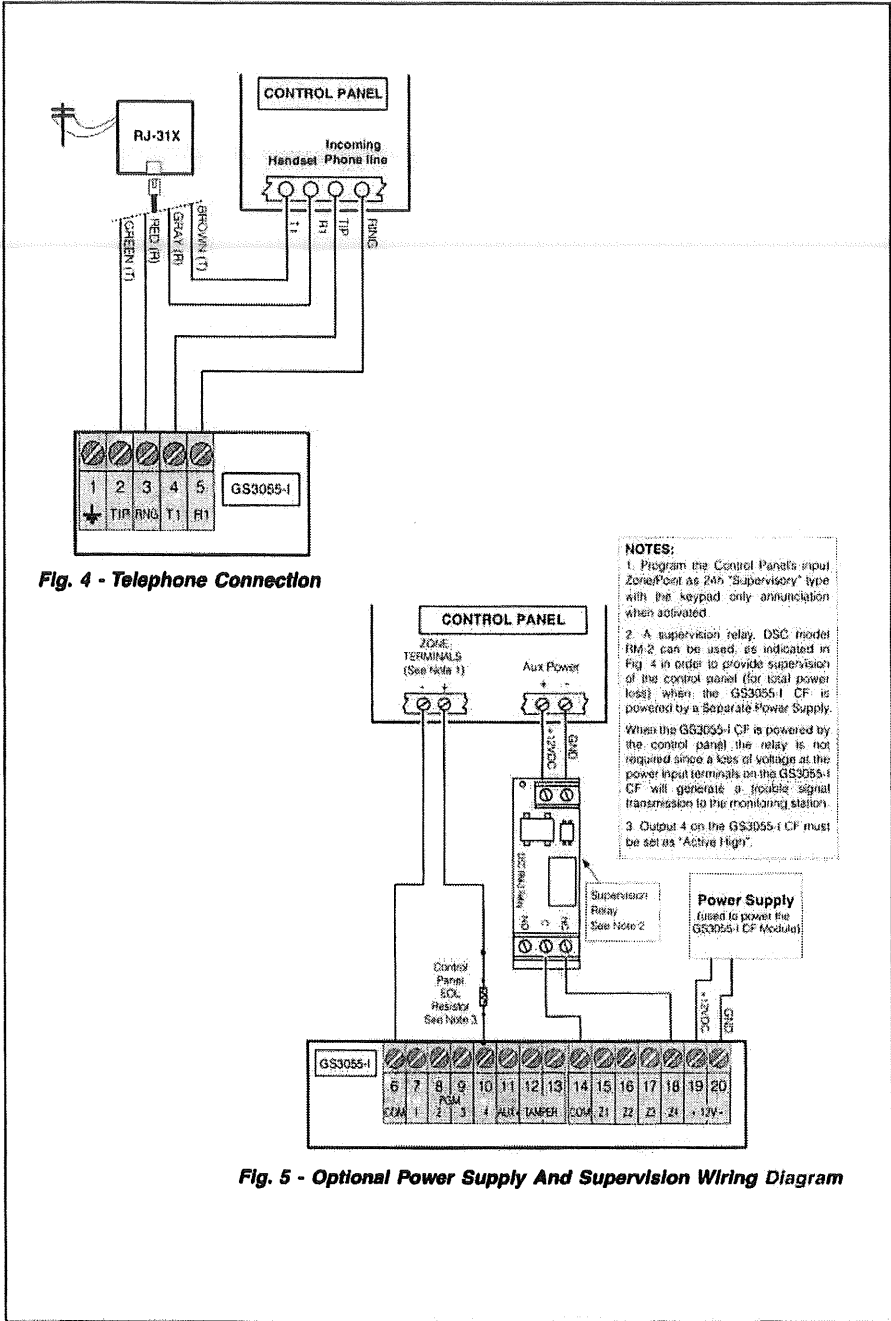

Fig. 3 - Power Supply Wiring Diagram



NOTES:

1. Program the Control Panel's input ZonePoint as 2nd "Supervisory" type with the keypad only annunciation when activated.
2. A supervision relay, DSC model RM-2 can be used, as indicated in Fig. 4 in order to provide supervision of the control panel (for total power loss) when the GS3055-1 CF is powered by a Separate Power Supply. When the GS3055-1 CF is powered by the control panel the relay is not required since a loss of voltage at the power input terminals on the GS3055-1 CF will generate a trouble signal transmission to the monitoring station.
3. Output 4 on the GS3055-1 CF must be set as "Active High".

FCC COMPLIANCE STATEMENT

CAUTION: Changes or modifications not expressly approved by Digital Security Controls could void your authority to use this equipment. This equipment generates and uses radio frequency energy and if not installed and used properly, in strict accordance with the manufacturer's instructions, may cause interference to radio and television reception. It has been type tested and found to comply with the limits for Class B device in accordance with the specifications in Subpart "B" of Part 15 of FCC Rules, which are designed to provide reasonable protection against such interference in any residential installation. However, there is no guarantee that interference will not occur in a particular installation. If this equipment does cause interference to television or radio reception, which can be determined by turning the equipment off and on, the user is encouraged to try to correct the interference by one or more of the following measures:

- Re-orient the receiving antenna
- Relocate the alarm control with respect to the receiver
- Move the alarm control away from the receiver
- Connect the alarm control into a different outlet so that alarm control and receiver are on different circuits

If necessary, the user should consult the dealer or an experienced radio/television technician for additional suggestions. The user may find the following booklet prepared by the FCC helpful: "How to Identify and Resolve Radio/Television Interference Problems". This booklet is available from the U.S. Government Printing Office, Washington, D.C. 20402, Stock # 004-000-00345-4.

IMPORTANT INFORMATION

This equipment complies with Part 68 of the FCC Rules. On the side of this equipment is a label that contains, among other information, the FCC registration number and ringer equivalence number (REN) for this equipment. If requested, this number must be provided to the Telephone Company.

GS3055-1 CF Product Identifier US: F33AL00BGS3055

REN: 0.0B

USOC Jack: RJ-31X

Telephone Connection Requirements

A plug and jack used to connect this equipment to the premises wiring and telephone network must comply with the applicable FCC Part 68 rules and requirements adopted by the ACTA. A compliant telephone cord and modular plug is provided with this product. It is designed to be connected to a compatible modular jack that is also compliant. See installation instructions for details.

Ringer Equivalence Number (REN)

The REN is used to determine the number of devices that may be connected to a telephone line. Excessive RENs on a telephone line may result in the devices not ringing in response to an incoming call.

In most but not all areas, the sum of RENs should not exceed five (5.0). To be certain of the number of devices that may be connected to a line, as determined by the total RENs, contact the local Telephone Company. For products approved after July 23, 2001, the REN for this product is the product identifier that has the format US: AAAEQ#TXXXX. The digits represented by ## are the REN without a decimal point (e.g., .03 is a REN of 0.3). For earlier products, the REN is separately shown on the label.

Incidence of Harm

If this equipment GS3055-1 CF causes harm to the telephone network, the telephone company will notify you in advance that temporary discontinuance of service may be required. But if advance notice is not practical, the Telephone Company will notify the customer as soon as possible. Also, you will be advised of your right to file a complaint with the FCC if you believe it is necessary.

Changes in Telephone Company Equipment or Facilities

The Telephone Company may make changes in its facilities, equipment, operations or procedures that could affect the operation of the equipment. If this happens the Telephone Company will provide advance notice in order for you to make necessary modifications to maintain uninterrupted service.

Equipment Maintenance Facility

If trouble is experienced with this equipment for repair or warranty information, please contact the facility indicated below. If the equipment is causing harm to the telephone network, the Telephone Company may request that you disconnect the equipment until the problem is solved. This equipment is of a type that is not intended to be repaired by the end user.

DSC c/o APL Logistics, 757 Douglas Hill Rd., Lithia Springs, GA 30122

Additional Information

Connection to party line service is subject to state tariffs. Contact the state public utility commission, public service commission or corporation commission for information.

Alarm dialling equipment must be able to seize the telephone line in use. To do so, in an emergency situation, it must be able to do this even if other equipment (telephone, answering system, computer modem, etc.) already has the telephone line in use. To do so, alarm dialling equipment must be connected to a properly installed RJ-31X jack that is electrically in series with and ahead of all other equipment attached to the same telephone line. Proper installation is depicted in the figure below. If you have any questions concerning these instructions, you should consult your telephone company or a qualified installer about installing the RJ-31X jack and alarm dialling equipment for you.

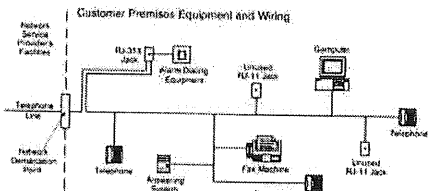

Industry Canada Compliance Statement

This Equipment meets the applicable Industry Canada Terminal Equipment Technical Specifications. This is confirmed by the registration number. The abbreviation, IC, before the registration number signifies that registration was performed based on a Declaration of Conformity indicating that Industry Canada technical specifications were met. It does not imply that Industry Canada approved the equipment. The Ringer Equivalence Number (REN) for this terminal equipment is 0.0. The REN assigned to each terminal equipment provides an indication of the maximum number of terminals allowed to be connected to a telephone interface. The termination on an interface may consist of any combination of devices subject only to the requirement that the sum of the Ringer Equivalence Numbers of all devices does not exceed 5.

Cet équipement est conforme aux spécifications techniques applicables aux équipements terminaux d'Industrie Canada. Ceci est confirmé par le numéro d'enregistrement. L'abréviation IC précédant le numéro d'enregistrement signifie que l'enregistrement a été effectué sur la base de la Déclaration de conformité indiquant que le produit est conforme aux spécifications techniques d'Industrie Canada. Ceci n'implique pas que le produit ait été approuvé par Industrie Canada.

Le nombre équivalent de sonneries (REN) de cet appareil terminal est 0.0. Le REN attribué à chaque équipement terminal fournit une indication sur le nombre maximum de terminaux pouvant être connectés sur une interface téléphonique. La terminaison sur une interface peut constituer n'importe quelle combinaison d'appareils, à la condition seulement que la somme des Nombres équivalents de sonneries de tous les appareils ne soit pas supérieure à 5.

This Class B digital apparatus meets all requirements of the Canadian interference-causing equipment regulations. Cet appareil numérique de la Classe B respecte toutes les exigences de règlement sur le matériel brouilleur du Canada.

The term "IC:" before the radio certification number only signifies that Industry Canada technical specifications were met. This manual is applicable to the following GS3055-1 CF Cellular Alarm Communicator Models: GS3055-1 FCC ID: F3306GS30551 and IC: 160A-GS30551 GS3055-2 FCC ID: F3306GS30552 and IC: 160A-GS30552

WARNING: To satisfy FCC RF exposure requirements for mobile transmitting devices, a separation distance of 20cm or more must be maintained between the antenna of this device and persons during device operation.

Printed in Canada



29007393R005

NAC Circuit Voltage Drop Calculation

Project Name	Huntington Apartments Building 2		
Date	1/25/2013		
Circuit Number	1		
Area Covered	Ground Floor		
NAC Source Alarm Voltage	20.4	Wire Gauge	Resistance Per MFt Cable
Minimum Device Voltage	16		
Distance to first appliance	20		
Total Circuit Current	0.728		

Wire Gauge for balance of circuit	14	5.84
-----------------------------------	----	------

Circuit is within limits	Device Current	Distance from previous device	Voltage at Device	Drop from source	Percent Drop
Appliance 1	0.064		20.31	0.09	0.4%
Appliance 2	0.044	10	20.28	0.12	0.6%
Appliance 3	0.078	25	20.19	0.21	1.1%
Appliance 4	0.044	30	20.09	0.31	1.5%
Appliance 5	0.078	15	20.05	0.35	1.7%
Appliance 6	0.044	25	19.99	0.41	2.0%
Appliance 7	0.044	30	19.92	0.48	2.4%
Appliance 8	0.078	35	19.85	0.55	2.7%
Appliance 9	0.044	25	19.81	0.59	2.9%
Appliance 10	0.044	25	19.78	0.62	3.0%
Appliance 11	0.044	25	19.76	0.64	3.1%
Appliance 12	0.044	25	19.74	0.66	3.2%
Appliance 13	0.078	15	19.74	0.66	3.3%
END	0.000	0	19.74	0.66	3.3%
END	0.000	0	19.74	0.66	3.3%
END	0.000	0	19.74	0.66	3.3%
END	0.000	0	19.74	0.66	3.3%
END	0.000	0	19.74	0.66	3.3%
END	0.000	0	19.74	0.66	3.3%
END	0.000	0	19.74	0.66	3.3%
END	0.000	0	19.74	0.66	3.3%
END	0.000	0	19.74	0.66	3.3%
END	0.000	0	19.74	0.66	3.3%
END	0.000	0	19.74	0.66	3.3%
END	0.000	0	19.74	0.66	3.3%
END	0.000	0	19.74	0.66	3.3%
END	0.000	0	19.74	0.66	3.3%
Totals	0.728	305			

Appliance circuit voltage drop calculations start at "end of battery life" as NAC Source Alarm Voltage and use 20% below nameplate rating for Minimum Appliance Voltage.

Note. Wire resistance is based on the 1996 NEC Table 8 Uncoated DC resistance. Solid conductors except gauges 10 and 12 which are for stranded.

NAC Circuit Voltage Drop Calculation

Project Name	Huntington Apartments Building 2		
Date	1/25/2013		
Circuit Number	2		
Area Covered	1st Floor		
NAC Source Alarm Voltage	20.4	Wire Gauge	Resistance
Minimum Device Voltage	16	14	Per Mft Cable
Distance to first appliance	40		5.84
Total Circuit Current	0.664		

Wire Gauge for balance of circuit	14	5.84
-----------------------------------	----	------

	Device Current	Distance from previous device	Voltage at Device	Drop from source	Percent Drop
Circuit is within limits					
Appliance 1	0.078		20.24	0.16	0.8%
Appliance 2	0.044	10	20.21	0.19	0.9%
Appliance 3	0.044	25	20.13	0.27	1.3%
Appliance 4	0.078	30	20.04	0.36	1.7%
Appliance 5	0.044	15	20.01	0.39	1.9%
Appliance 6	0.044	25	19.95	0.45	2.2%
Appliance 7	0.078	30	19.89	0.51	2.5%
Appliance 8	0.044	35	19.84	0.56	2.7%
Appliance 9	0.044	25	19.81	0.59	2.9%
Appliance 10	0.044	25	19.79	0.61	3.0%
Appliance 11	0.044	25	19.77	0.63	3.1%
Appliance 12	0.078	25	19.76	0.64	3.1%
END	0.000	0	19.76	0.64	3.1%
END	0.000	0	19.76	0.64	3.1%
END	0.000	0	19.76	0.64	3.1%
END	0.000	0	19.76	0.64	3.1%
END	0.000	0	19.76	0.64	3.1%
END	0.000	0	19.76	0.64	3.1%
END	0.000	0	19.76	0.64	3.1%
END	0.000	0	19.76	0.64	3.1%
END	0.000	0	19.76	0.64	3.1%
END	0.000	0	19.76	0.64	3.1%
END	0.000	0	19.76	0.64	3.1%
END	0.000	0	19.76	0.64	3.1%
END	0.000	0	19.76	0.64	3.1%
END	0.000	0	19.76	0.64	3.1%
Totals	0.664	310			

Appliance circuit voltage drop calculations start at "end of battery life" as NAC Source Alarm Voltage and use 20% below nameplate rating for Minimum Appliance Voltage.

Note. Wire resistance is based on the 1996 NEC Table 8 Uncoated DC resistance. Solid conductors except gauges 10 and 12 which are for stranded.

NAC Circuit Voltage Drop Calculation

Project Name	Huntington Apartments Building 2		
Date	1/25/2013		
Circuit Number	3		
Area Covered	1st Floor		
NAC Source Alarm Voltage	20.4	Wire Gauge	Resistance
Minimum Device Voltage	16	14	Per MFt Cable
Distance to first appliance	60		5.84
Total Circuit Current	0.664		

Wire Gauge for balance of circuit	14	5.84
-----------------------------------	----	------

	Device Current	Distance from previous device	Voltage at Device	Drop from source	Percent Drop
Circuit is within limits					
Appliance 1	0.078		20.17	0.23	1.1%
Appliance 2	0.044	10	20.13	0.27	1.3%
Appliance 3	0.044	25	20.05	0.35	1.7%
Appliance 4	0.078	30	19.97	0.43	2.1%
Appliance 5	0.044	15	19.93	0.47	2.3%
Appliance 6	0.044	25	19.88	0.52	2.6%
Appliance 7	0.078	30	19.82	0.58	2.9%
Appliance 8	0.044	35	19.76	0.64	3.1%
Appliance 9	0.044	25	19.73	0.67	3.3%
Appliance 10	0.044	25	19.71	0.69	3.4%
Appliance 11	0.044	25	19.69	0.71	3.5%
Appliance 12	0.078	25	19.68	0.72	3.5%
END	0.000	0	19.68	0.72	3.5%
END	0.000	0	19.68	0.72	3.5%
END	0.000	0	19.68	0.72	3.5%
END	0.000	0	19.68	0.72	3.5%
END	0.000	0	19.68	0.72	3.5%
END	0.000	0	19.68	0.72	3.5%
END	0.000	0	19.68	0.72	3.5%
END	0.000	0	19.68	0.72	3.5%
END	0.000	0	19.68	0.72	3.5%
END	0.000	0	19.68	0.72	3.5%
END	0.000	0	19.68	0.72	3.5%
END	0.000	0	19.68	0.72	3.5%
END	0.000	0	19.68	0.72	3.5%
Totals	0.664	330			

Appliance circuit voltage drop calculations start at "end of battery life" as NAC Source Alarm Voltage and use 20% below nameplate rating for Minimum Appliance Voltage.

Note. Wire resistance is based on the 1996 NEC Table 8 Uncoated DC resistance. Solid conductors except gauges 10 and 12 which are for stranded.

Siemens FACP Battery Calculations

Job Name: HUNTINGTON APTS

Date: 1/25/2013

TOTAL SYSTEM CURRENT	STANDBY	ALARM
	0.393	2.080

TOTAL FACP BATTERY CALCULATIONS			
TOTAL STANDBY CURRENT	A/H REQ'D		A/H STANDBY
0.393 Amps X	24 HRS.		9.422
TOTAL ALARM CURRENT	A/H REQ'D		A/H ALARM
2.080 Amps X	5 MIN.		0.217

Required Battery Capacity	9.639
Always use a battery with higher AH rating than required.	

BATTERY SUPPLIED: 2x12 AH

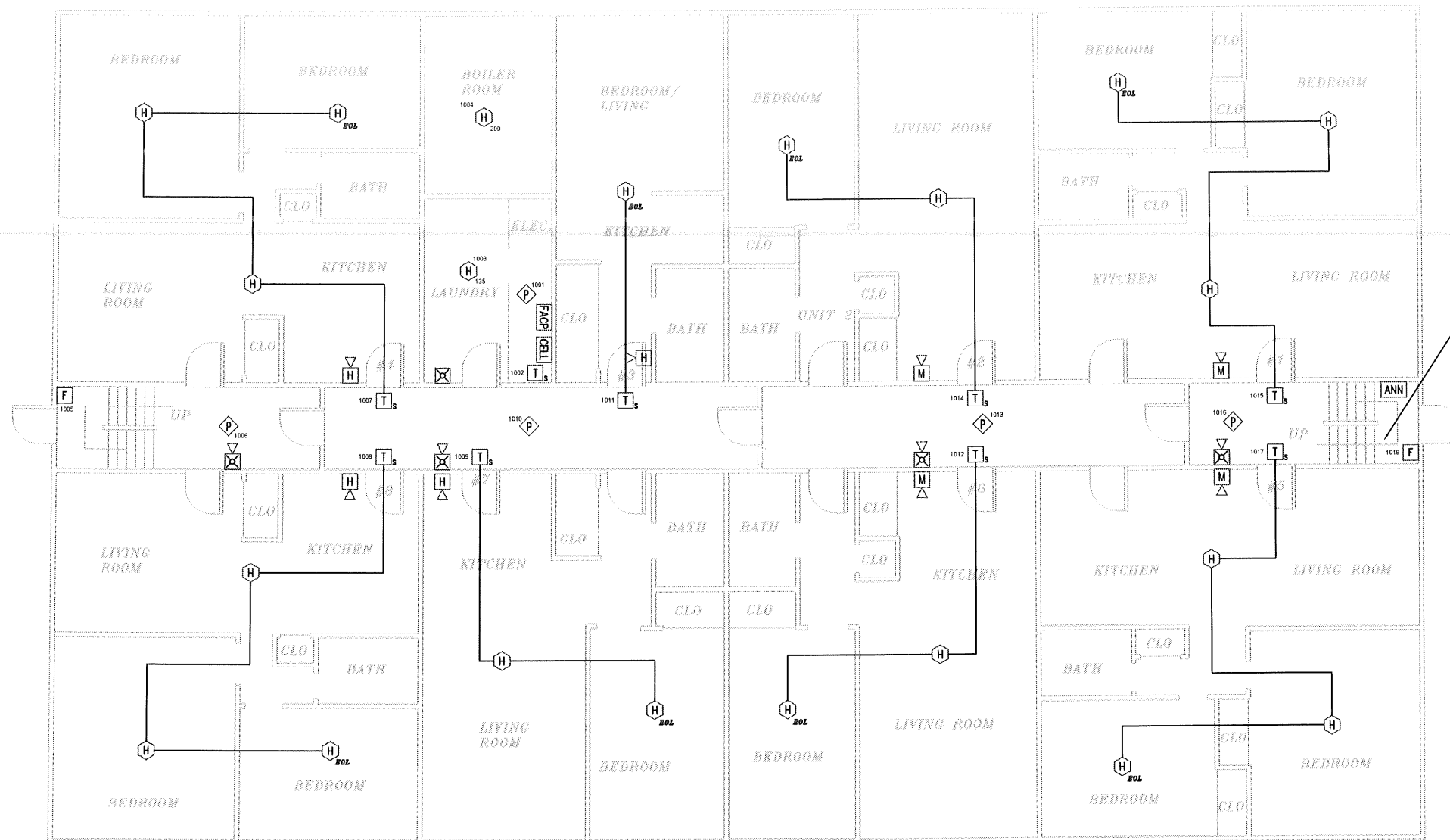

LOCATE SMOKE DETECTOR
UNDER STAIR IN STORAGE AREA

FIRE ALARM SYSTEM LAYOUT – GROUND LEVEL

SCALE: 1/8"=1'

GENERAL NOTES	DATE	REVISIONS	REQUIRED APPROVALS	HUNTINGTON APTS 326 AUBURN ST PORTLAND, ME	FIRE ALARM SYSTEM BUILDING 2 PLANS & DETAILS
-SCOPE OF WORK: INSTALL NEW ADDRESSABLE FIRE ALARM SYSTEM. ALL INSTALLATION PRACTICES SHALL COMPLY WITH NFPA 70, 72			OWNER PORTLAND FIRE DEPARTMENT		
PHASE I: REPLACE CONTROL PANEL			DRAWN BY CRM	CONTRACT WITH: OWNER	JOB NUMBER
PHASE II: INSTALL NEW DEVICES			CHECKED BY MLT	EASTERN FIRE SERVICES, INC. AUBURN/LEWISTON INDUSTRIAL AIRPARK, AUBURN, MAINE 04210	SCALE 3/8"=1'
PHASE II TO BE COMPLETED IMMEDIATELY AFTER PHASE I			CONTRACTOR LICENSE #		DATE 1/25/13

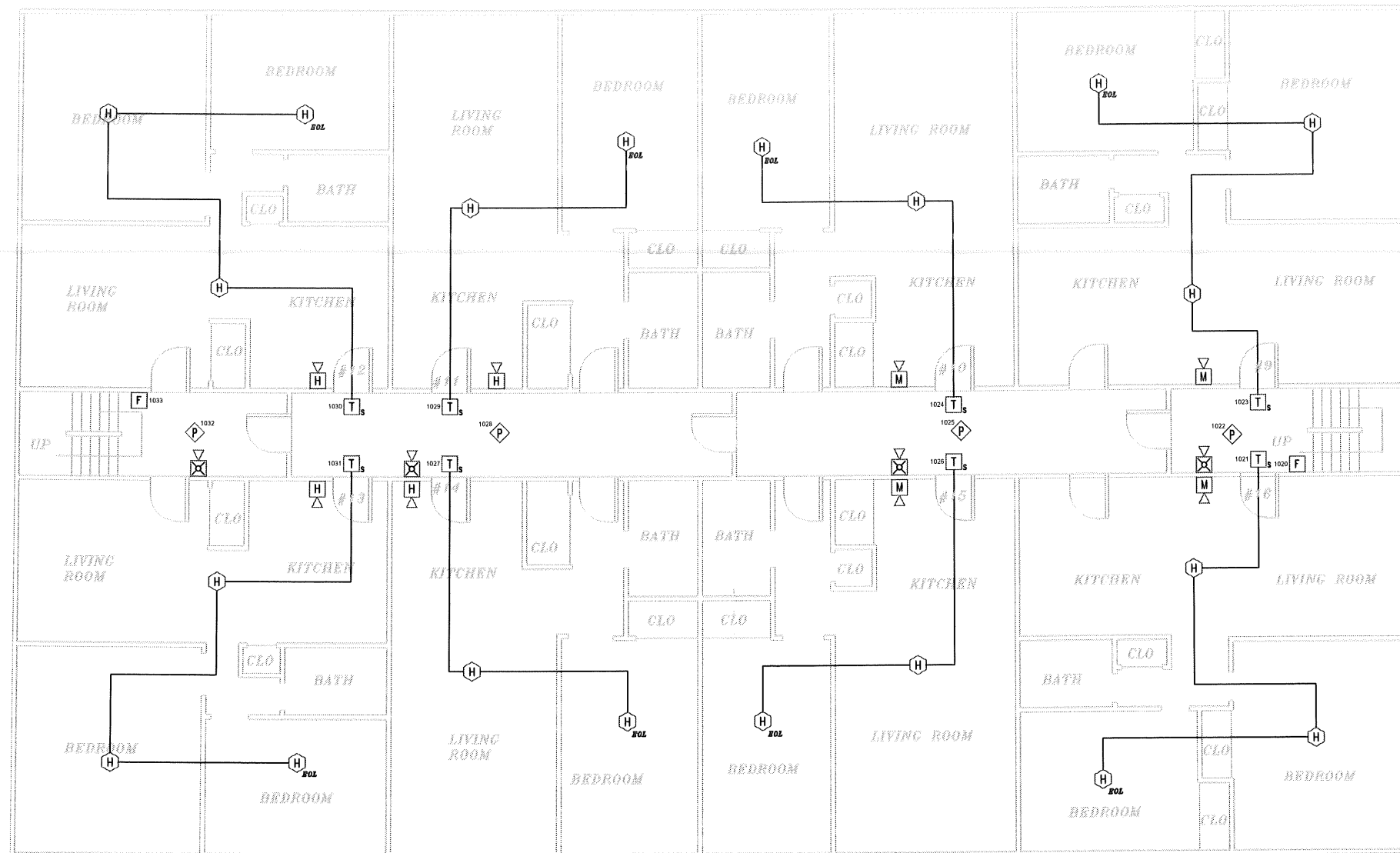

FIRE ALARM SYSTEM LAYOUT – FIRST FLOOR

SCALE: 1/8"=1'

GENERAL NOTES	DATE	REVISIONS	REQUIRED APPROVALS	HUNTINGTON APTS 326 AUBURN ST PORTLAND, ME	FIRE ALARM SYSTEM BUILDING 2 PLANS & DETAILS
-SCOPE OF WORK: INSTALL NEW ADDRESSABLE FIRE ALARM SYSTEM. ALL INSTALLATION PRACTICES SHALL COMPLY WITH NFPA 70, 72			OWNER PORTLAND FIRE DEPARTMENT		CONTRACT WITH: OWNER
PHASE I: REPLACE CONTROL PANEL			DRAWN BY CRM	 EASTERN FIRE SERVICES, INC. AUBURN/LEWISTON INDUSTRIAL AIRPARK, AUBURN, MAINE 04210	
PHASE II: INSTALL NEW DEVICES			CHECKED BY MLT		SCALE 3/32"=1'
PHASE II TO BE COMPLETED IMMEDIATELY AFTER PHASE I			CONTRACTOR LICENSE #		DATE 1/25/13

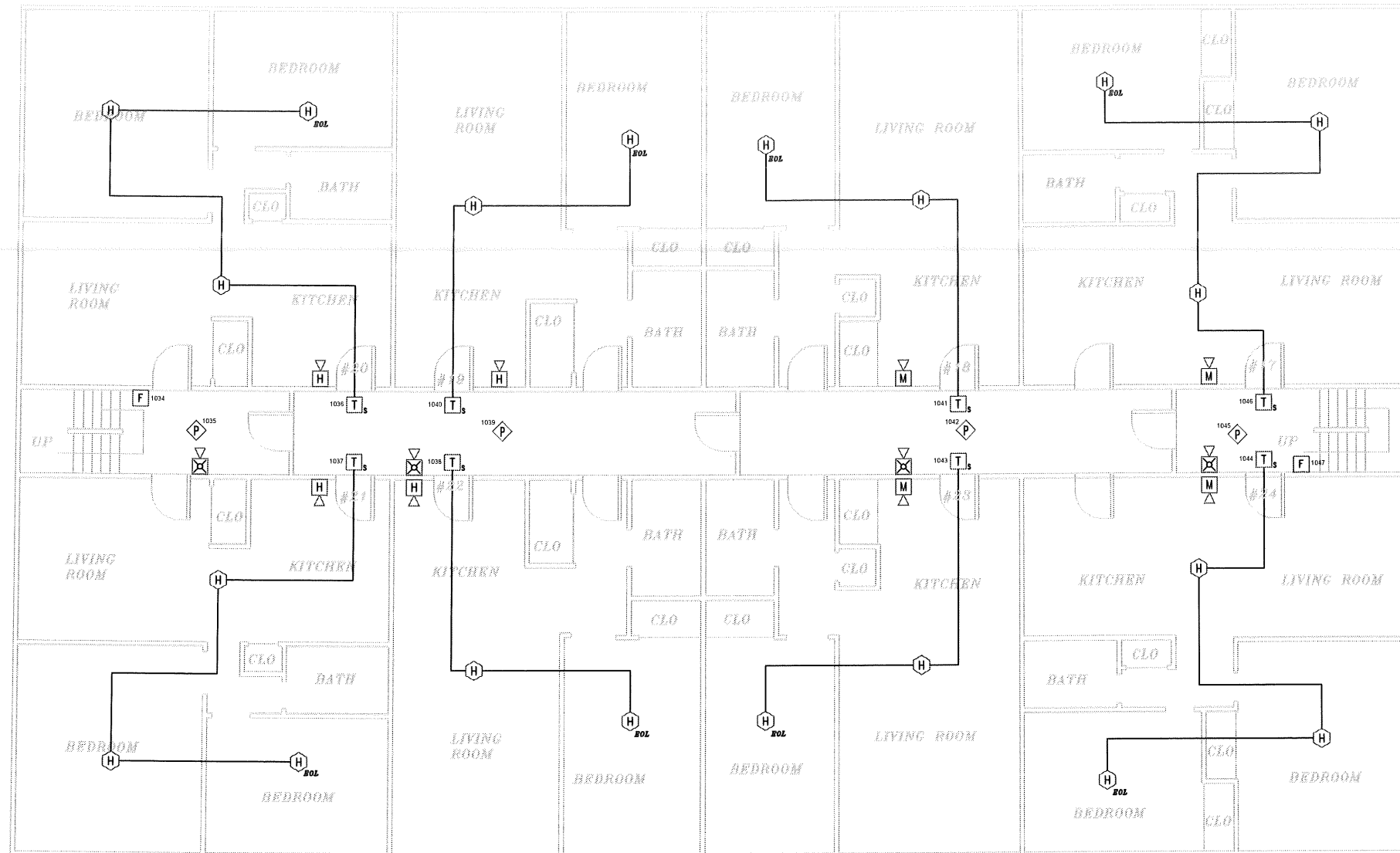

FIRE ALARM SYSTEM LAYOUT – SECOND FLOOR

SCALE: 1/8"=1'

GENERAL NOTES	DATE	REVISIONS	REQUIRED APPROVALS	HUNTINGTON APTS 326 AUBURN ST PORTLAND, ME	FIRE ALARM SYSTEM BUILDING 2 PLANS & DETAILS
-SCOPE OF WORK: INSTALL NEW ADDRESSABLE FIRE ALARM SYSTEM. ALL INSTALLATION PRACTICES SHALL COMPLY WITH NFPA 70, 72			OWNER PORTLAND FIRE DEPARTMENT		CONTRACT WITH: OWNER
PHASE I: REPLACE CONTROL PANEL			DRAWN BY CRM		
PHASE II: INSTALL NEW DEVICES			CHECKED BY MLT		SCALE 3/8" = 1'
PHASE II TO BE COMPLETED IMMEDIATELY AFTER PHASE I			CONTRACTOR LICENSE #		DATE 1/25/13

SYMBOL LEGEND

QUANT.	SYM.	DESCRIPTION	MODEL	BACK BOX
1	[FACP]	FIRE ALARM CONTROL PANEL	FS-250	
1	[DACT]	DIGITAL COMMUNICATOR	FS-DACT	
1	[CELL]	CELLULAR COMMUNICATOR	GS3055-ICF	
1	[ANN]	FIRE ALARM ANNUNCIATOR	FS-RD2	
14	[◇]	CEILING SMOKE DETECTOR/BASE	HFP-11/DB-11	SINGLE GANG OR OCTOGON BOX
1	[H ₁₃₅]	THERMAL DETECTOR/ BASE	HFPT-11/DB-11	SINGLE GANG OR OCTOGON BOX
59	[H]	THERMAL DETECTOR/ BASE	DT-135R	SINGLE GANG OR OCTOGON BOX
1	[H ₂₀₀]	200 DEGREE THERMAL DETECTOR/ BASE	DT-200F/HTRI-M	SINGLE GANG OR OCTOGON BOX
6	[F]	MANUAL PULL STATION	MSM-KD/HTRI-M	3.5" DEEP SINGLE GANG
24	[T _s]	SINGLE INPUT MONITOR MODULE	HTRI-R	4" SQUARE BOX
24	[H<]	FIRE ALARM MULTI HORN	ZH-R	4" SQUARE
12	[X<]	FIRE ALARM MULTI CANDELLA HORN/STROBE	ZH-MC-R	4" SQUARE
1	[X]	FIRE ALARM MULTI CANDELLA STROBE	ZR-MC-R	4" SQUARE

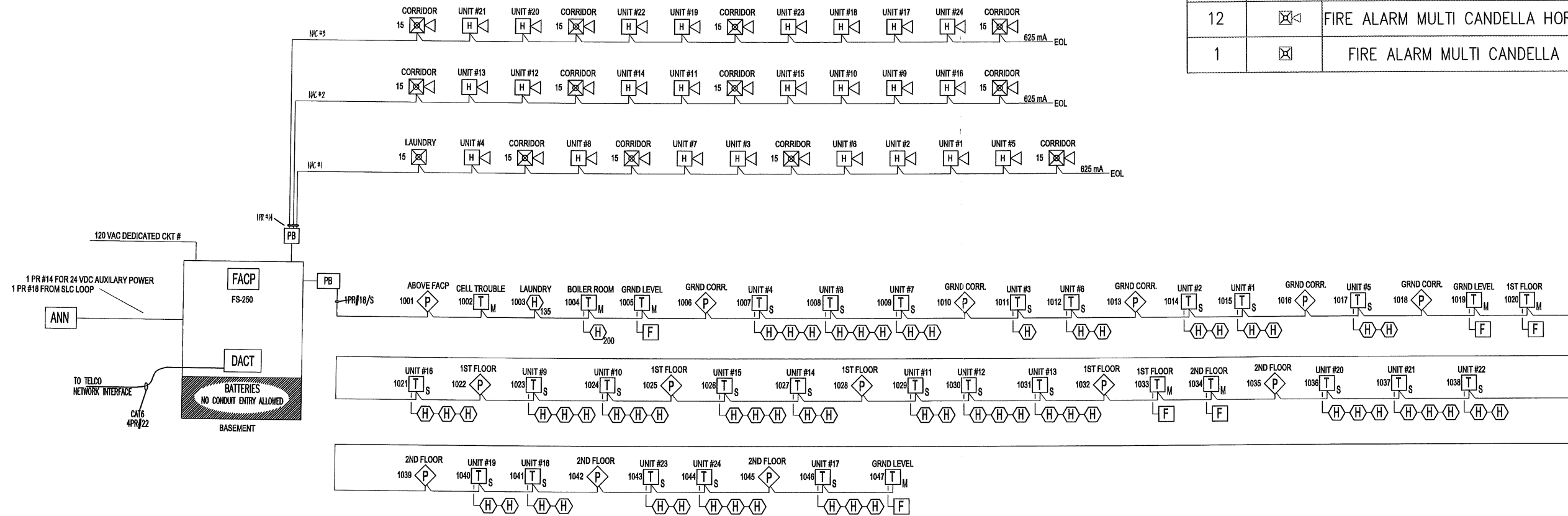

FIRE ALARM RISER DETAIL
SCALE: N.T.S.

GENERAL NOTES	DATE	REVISIONS	REQUIRED APPROVALS	HUNTINGTON APTS 326 AUBURN ST PORTLAND, ME	FIRE ALARM SYSTEM BUILDING 2 PLANS & DETAILS
-SCOPE OF WORK: INSTALL NEW ADDRESSABLE FIRE ALARM SYSTEM. ALL INSTALLATION PRACTICES SHALL COMPLY WITH NFPA 70, 72			OWNER PORTLAND FIRE DEPARTMENT		CONTRACT WITH: OWNER
PHASE I: REPLACE CONTROL PANEL			DRAWN BY CRM	JOB NUMBER	
PHASE II: INSTALL NEW DEVICES			CHECKED BY MLT	 EASTERN FIRE SERVICES, INC. AUBURN/LEWISTON INDUSTRIAL AIRPARK, AUBURN, MAINE 04210	SCALE NTS
PHASE II TO BE COMPLETED IMMEDIATELY AFTER PHASE I			CONTRACTOR LICENSE #		DATE 12/5/13

ELECTRICAL PERMIT

City of Portland, Maine

To the Electrical Inspector, Portland Maine:

The undersigned hereby applies for a permit to make electrical installations in accordance with the laws of Maine, the City of Portland's Electrical Ordinances, National Electrical Code and the following specifications:



Date: 02/15/13
 Permit #: 201300309
 CBL#: 383 A016

ADDRESS: 326 Auburn St #2 METER MAKE/MODEL #: _____
 CMP Work Order #: _____ OWNER: Gary Sidelinger
 TENANT: _____ PHONE #: _____

PLEASE HAVE YOUR PERMIT # (OR JOB ID) READY & CALL 874-8703 TO SCHEDULE AN INSPECTION!

TOTAL EACH FEE

OUTLETS:	Receptacles	Switches	Smoke Detector	0.20
FIXTURES:	Incandescent	Flourescent	Strips	0.20
SERVICES:	Overhead	Underground	TTL Amps <800	15.00
			TTL Amps >800	25.00
TEMPORARY SERVICE:	Overhead	Underground	TTL Amps	25.00
METERS:	(Number of)			1.00
MOTORS:	(Number of)			2.00
RESID/COMMER:	Electric Units			1.00
HEATING:	Oil/Gas Units	Interior	Exterior	5.00
APPLIANCES:	Ranges	Cook Tops	Wall Ovens	2.00
	Insta-hot	Water Heaters	Fans	2.00
	Dryers	Disposals	Dishwasher	2.00
	Compactors	Spa	Washing Machine	2.00
	Others (denote)			2.00
MISC. (# of):	Air Cond (Window)			3.00
	Air Cond (Central)		Pools	10.00
	HVAC	EMS	Thermostat	5.00
	Signs			10.00
	Alarms/Resident			5.00
	X Alarms/Commer			15.00
	Heavy Duty (CRKT)			2.00
	Alterations			5.00
	Fire Repairs			15.00
	Emergency Lights			1.00
	Emer Generators			20.00
	Circus/Carnival			25.00
PANELS:	Service	Remote	Main	4.00
TRANSFORMER:	0-25 Kva			5.00
	25-200 Kva			8.00
	Over 200 Kva			10.00

CBL: 383 A016 #2

RECEIVED
FEB 15 2013
 Dept. of Building Inspections
 City of Portland Maine

MINIMUM COMMERCIAL FEE: \$55.00

MINIMUM RESIDENTIAL FEE: \$45.00

Brief Description of work:

TOTAL DUE:

55

PLEASE HAVE YOUR PERMIT # (OR JOB ID) READY & CALL 874-8703 TO SCHEDULE AN INSPECTION!

CONTRACTOR INFORMATION:

Contractor Name: Eastern Fire Services Paul Shaw Master License #: MS6001657
 Address: 120 Kitty Hawk Ave Auburn, Maine 04211 Limited License #: _____
 Telephone: 207-784-1507

Contractor Signature:

PLEASE HAVE YOUR PERMIT # (OR JOB ID) READY & CALL 874-8703 TO SCHEDULE AN INSPECTION!

CITY OF PORTLAND
DEPARTMENT OF PLANNING & URBAN DEVELOPMENT
 389 Congress Street
 Portland, Maine 04101

ELECTRICAL PERMITS RECEIPT

Application No: 2013-00309	Applicant: HUNTINGTON APTS PARTNERS
Project Desc: Electric for Fire Alarm system, Buil	Location: 326 AUBURN ST
CBL: 383 A016001	Electrician: PAUL A. SHAW
Invoice Date: 02/15/2013	License #: MS60016657

Previous Balance	-	Payment Received	+	Current Fees	-	Current Payment	=	Total Due	Payment Due Date
\$0.00		\$0.00		\$55.00		\$55.00		\$0.00	On Receipt

Previous Balance **\$0.00**

Fee Description	Qty	Fee
Electrical Commercial	1	\$55.00
		\$55.00

Total Current Payments: - **\$55.00**
Minimum Amount Due Now: **\$0.00**

CBL: 383 A016001 **Application No:** 2013-00309
Bill to: HUNTINGTON APTS PARTNERSHIP
 PO BOX 1003
 PORTLAND, ME 04104

Invoice Date: 02/15/2013
Invoice No: 40135
Total Amt Due: \$0.00
Payment Amount: \$55.00

Make checks payable to the *City of Portland*, ATTN: Inspections, 3rd Floor, 389 Congress Street, Portland, ME 04101.

CITY OF PORTLAND
DEPARTMENT OF PLANNING & URBAN DEVELOPMENT
 389 Congress Street
 Portland, Maine 04101

RECEIPT OF FEES

Application No: 201300308	Applicant: HUNTINGTON APTS PARTNERS
Project Name: Fire Alarm systemt for Building 2	Location: 326 AUBURN ST
CBL: 383 A016001	Permit Type: Fire Alarm System
Invoice Date: 02/15/2013	

Previous Balance	-	Payment Received	+	Current Fees	-	Current Payment	=	Total Due		Payment Due Date
\$0.00		\$0.00		\$320.00		\$320.00		\$0.00		On Receipt

Previous Balance **\$0.00**

Fee Description	Qty	Fee/Deposit Charge
Building Permit Fee First \$1000	1	\$30.00
Building Permit Fee Add'l \$1000	1	\$290.00
		\$320.00
Total Current Fees:	+	\$320.00
Total Current Payments:	-	\$320.00
Amount Due Now:		\$0.00

CBL 383 A016001
Bill to: HUNTINGTON APTS PARTNERSHIP
 PO BOX 1003
 PORTLAND, ME 04104

Application No: 201300308
Invoice Date: 02/15/2013
Invoice No: 40134
Total Amt Due: \$0.00
Payment Amount: \$320.00

Make checks payable to the *City of Portland*, ATTN: Inspections, 3rd Floor, 389 Congress Street, Portland, ME 04101.

*Strengthening a Remarkable City,
Building a Community for Life*

**PORTLAND
MAINE**

Inspections Division

389 Congress Street, RM 315
Portland, Maine 04101-3509

**EASTERN FIRE SERVICES
RE: 326 AUBURN ST #2 PERMIT
170 KITTYHAWK AVENUE
AUBURN ME 04211**