

10/6/98 - Called Mr. Sutebyer - over condition of his Sec. - He will call if any? - or will call B-4 from Engr. - He will supply

no copy of Mfg Specs per condition #29C

10/6/98 Water site & not of owner - Pops already in - Able to observe 6" + Re Rod - Although

Some are in they are not required - Checked w/PSH - ok - Also checked w/PSH of

St. Max on fire walls to bldg. then Adv. 5/8 against bldg. Then 2x4 on flat side for

spread and 5/8" - Installation in traps will be ok - Also - If using K-1 no

Containment required / If #2 or heavier must have Containment for

110% of Capacity - If double wall tanks used they act as Containment

vessels - Owner will also have to Amend permit & submit

plans for Cheminsep. Owner will also submit Mfg Specs per requirement

#29C (See Separate Bailer permit)

10/7/98 Talked w/owner & discussed all of above -

10/13/98 Submitted Cheminsep detail for approval

Sent Copy of Cheminsep requirements to Gary Side Gager -

10/14/98 - Ch framing - will have to top in dips vents w/Sheetrock Remove

Above Vents & replace with internal hood/exhaust system

Type	Inspection Record	Date
Foundation:		
Framing:		
Plumbing:		
Final:		
Other:		

10/6/98 - Called Mr. Subelger - Owner - Over Completion of the Sec. - He will call if any? - or will call B-4 from Engr. - He will supply

no copy of Mfg Specs per Condition #29 C

10/6/98 - 1/2" x 1/2" x 1/2" - Peds clear of in - Able to observe 6" + re rod - Although some are in they are not required - check w/PSH - ok - Also checked w/PSH & Dr. Moe on fire walls to bldg. then Adv. 5/8 against s/dy then 2x4 on flat side for

spread and 5/8" - Granulation in trap will be ok - Also - If using K-1 no Containment required / If #2 or heavier must have Containment for 110% of Capacity - If double wall tanks used they do as Containment

Persecho - Owner will also have to Amend permit & submit plan for Cheminsep. Owner will also submit Mfg Specs per Requirement #29 C

10/7/98 - Talked Warner & discussed all of above - 10/13/98 - Submitted Cheming detail for approval to Sent Copy of Cheming Requirements to Gary Subelger -

10/14/98 - Ok framing - will have to top in dips vents w/Sheetrock Personnel Above Vents & replace with internal hood/exhaust system

Inspection Record	
Type	Date
Foundation:	
Framing:	
Plumbing:	
Final:	
Other:	

BUILDING PERMIT REPORT

DATE: 14/Oct./98 ADDRESS: 65 Lambert ST CBL 382A-B-001

REASON FOR PERMIT: Chimney

BUILDING OWNER: Tara Apt. LLC

CONTRACTOR: . . .

PERMIT APPLICANT: . . .

USE GROUP: R-2 BOCA 1996 CONSTRUCTION TYPE: 53

CONDITION(S) OF APPROVAL

This Permit is being issued with the understanding that the following conditions are met:

Approved with the following conditions: *6, *31

10/14 Copy sent to Jerry Underberger also direct road w/John

*6-

1. This permit does not excuse the applicant from meeting applicable State and Federal rules and laws.
2. Before concrete for foundation is placed, approvals from the Development Review Coordinator and Inspection Services must be obtained. (A 24 hour notice is required prior to inspection)
- 2.5 Foundation drain shall be placed around the perimeter of a foundation that consists of gravel or crushed stone containing not more than 10 percent material that passes through a No. 4 sieve. The drain shall extend a minimum of 12 inches beyond the outside edge of the footing. The thickness shall be such that the bottom of the drain is not higher than the bottom of the base under the floor, and that the top of the drain is not less than 6 inches above the top of the footing. The top of the drain shall be covered with an approved filter membrane material. Where a drain tile or perforated pipe is used, the invert of the pipe or tile shall not be higher than the floor elevation. The top of joints or top of perforations shall be protected with an approved filter membrane material. The pipe or tile shall be placed on not less than 2" of gravel or crushed stone, and shall be covered with not less than 6" of the same material. Section 1813.5.2
- 2.6 Foundations anchors shall be a minimum of 1/2" in diameter, 7" into the foundation wall, minimum of 12" from corners of foundation and a maximum 6' o.c. between bolts. (Section 2305.17)
3. Precaution must be taken to protect concrete from freezing. Section 1908.0
4. It is strongly recommended that a registered land surveyor check all foundation forms before concrete is placed. This is done to verify that the proper setbacks are maintained.
5. Private garages located beneath habitable rooms in occupancies in Use Group R-1, R-2, R-3 or I-1 shall be separated from adjacent interior spaces by fire partitions and floor/ceiling assembly which are constructed with not less than 1-hour fire resisting rating. Private garages attached side-by-side to rooms in the above occupancies shall be completely separated from the interior spaces and the attic area by means of 1/2 inch gypsum board or the equivalent applied to the garage means of 1/2 inch gypsum board or the equivalent applied to the garage side. (Chapter 4 Section 407.0 of the BOCA/1996)
All chimneys and vents shall be installed and maintained as per Chapter 12 of the City's Mechanical Code. (The BOCA National Mechanical Code/1993). Chapter 12 & NFPA 211
7. Sound transmission control in residential building shall be done in accordance with Chapter 12 section 1214.0 of the city's building code.
8. Guardrails & Handrails: A guardrail system is a system of building components located near the open sides of elevated walking surfaces for the purpose of minimizing the possibility of an accidental fall from the walking surface to the lower level. Minimum height all Use Groups 42", except Use Group R which is 36". In occupancies in Use Group A, B, H-4, I-1, I-2 M and R and public garages and open parking structures, open guards shall have balusters or be of solid material such that a sphere with a diameter of 4" cannot pass through any opening. Guards shall not have an ornamental pattern that would provide a ladder effect. (Handrails shall be a minimum of 34" but not more than 38". Use Group R-3 shall not be less than 30", but not more than 38".) Handrail grip size shall have a circular cross section with an outside diameter of at least 1 1/4" and not greater than 2". (Sections 1021 & 1022.0) - Handrails shall be on both sides of stairway. (Section 1014.7)
9. Headroom in habitable space is a minimum of 7'6". (Section 1204.0)
10. Stair construction in Use Group R-3 & R-4 is a minimum of 10" tread and 7 3/4" maximum rise. All other Use group minimum 11" tread, 7" maximum rise.(Section 1014.0)
11. The minimum headroom in all parts of a stairway shall not be less than 80 inches. (6' 8") 1014.4

12. Every sleeping room below the fourth story in buildings of use Groups R and I-1 shall have at least one operable window or exterior door approved for emergency egress or rescue. The units must be operable from the inside without the use of special knowledge or separate tools. Where windows are provided as means of egress or rescue they shall have a sill height not more than 44 inches (1118mm) above the floor. All egress or rescue windows from sleeping rooms shall have a minimum net clear opening height dimension of 24 inches (610mm). The minimum net clear opening width dimension shall be 20 inches (508mm), and a minimum net clear opening of 5.7 sq. ft. (Section 1018.6)
13. Each apartment shall have access to two (2) separate, remote and approved means of egress. A single exit is acceptable when it exits directly from the apartment to the building exterior with no communications to other apartment units. Section 1010.1
14. All vertical openings shall be enclosed with construction having a fire rating of at least one (1) hour, including fire doors with self closer's. (Over 3 stories in height requirements for fire rating is two (2) hours.) Section 710.0
15. The boiler shall be protected by enclosing with (1) hour fire-rated construction including fire doors and ceiling, or by providing automatic extinguishment. Table 302.1.1
16. All single and multiple station smoke detectors shall be of an approved type and shall be installed in accordance with the provisions of the City's Building Code Chapter 9, Section 920.3.2 (BOCA National Building Code/1996), and NFPA 101 Chapter 18 & 19. (Smoke detectors shall be installed and maintained at the following locations):
 - In the immediate vicinity of bedrooms
 - In all bedrooms
 - In each story within a dwelling unit, including basements
 In addition to the required AC primary power source, required smoke detectors in occupancies in Use Groups R-2, R-3 and I-1 shall receive power from a battery when the AC primary power source is interrupted. (Interconnection is required) Section 920.3.2
17. A portable fire extinguisher shall be located as per NFPA #10. They shall bear the label of an approved agency and be of an approved type. Section 921.0
18. The Fire Alarm System shall be maintained to NFPA #72 Standard.
19. The Sprinkler System shall maintained to NFPA #13 Standard.
20. All exit signs, lights, and means of egress lighting shall be done in accordance with Chapter 10 Section & Subsections 1023. & 1024. Of the City's building code. (The BOCA National Building Code/1996)
21. Section 25-135 of the Municipal Code for the City of Portland states, "No person or utility shall be granted a permit to excavate or open any street or sidewalk from the time of November 15 of each year to April 15 of the following year".
22. The builder of a facility to which Section 4594-C of the Maine State Human Rights Act Title 5 MRSA refers, shall obtain a certification from a design professional that the plans commencing construction of the facility, the builder shall submit the certification to the Division of Inspection Services.
23. Ventilation shall meet the requirements of Chapter 12 Sections 1210. Of the City's Building Code. (crawl spaces & attics)
24. All electrical, plumbing and HVAC permits must be obtained by a Master Licensed holders of their trade.
25. All requirements must be met before a final Certificate of Occupancy is issued.
26. All building elements shall meet the fastening schedule as per Table 2305.2 of the City's Building Code. (The BOCA National Building Code/1996).
27. Ventilation of spaces within a building shall be done in accordance with the City's Mechanical Code (The BOCA National Mechanical Code/1993). (Chapter M-16)
28. Please read and implement the attached Land Use-Zoning report requirements.
29. Boring, cutting and notching shall be done in accordance with Sections 2305.4.4, 2305.5.1 and 2305.3. of the City's building code.
30. Glass and glazing shall meet the requirements of Chapter 24 of the building code.
- X 31. Please read and implement requirement from NFPA 211
Chimney. (see attached)
32. _____
33. _____

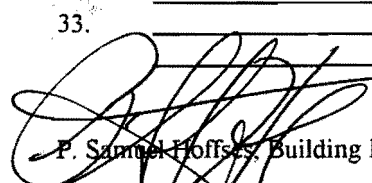
 F. Samuel Hoffner, Building Inspector
 cc: Lt. McDougan, PFD
 Marge Schmuckal, Zoning Administrator

THIS IS NOT A PERMIT/CONSTRUCTION CANNOT COMMENCE UNTIL THE PERMIT IS ISSUED

**Building or Use Permit Pre-Application
Additions/Alterations/Accessory Structures
To Detached Single Family Dwelling**

PLEASE TO CALL TO PICK UP

In the interest of processing your application in the quickest possible manner, please complete the Information below for a Building or Use Permit.

NOTEIf you or the property owner owes real estate or personal property taxes or user charges on any property within the City, payment arrangements must be made before permits of any kind are accepted.**

Location/Address of Construction: <u>65 Lambert St. Portland ME.</u>		
Tax Assessor's Chart, Block & Lot Number Chart# <u>32A</u> Block# <u>B</u> Lot# <u>1</u>	Owner: <u>Tara Apts, LLC</u> <u>P.O. Box 1003</u> <u>Portland, ME. 04104</u>	Telephone#: <u>(207) 772-1849</u>
Owner's Address: <u>P.O. Box 1003</u> <u>Portland ME. 04104</u>	Lessee/Buyer's Name (If Applicable)	Cost Of Work: <u>\$ 2500.00</u> Fee: <u>25.00</u>
Proposed Project Description: (Please be as specific as possible) <u>Building 2 sheds ONE TO ENCLOSE FURNACE + ONE TO ENCLOSE HOT TANKS.</u>		
Contractor's Name, Address & Telephone <u>Work to be done in house.</u>		Rec'd By: <u>[Signature]</u>

- Separate permits are required for Internal & External Plumbing, HVAC and Electrical installation.
- All construction must be conducted in compliance with the 1996 B.O.C.A. Building Code as amended by Section 6-Art II.
- All plumbing must be conducted in compliance with the State of Maine Plumbing Code.
- All Electrical Installation must comply with the 1996 National Electrical Code as amended by Section 6-Art III.
- HVAC(Heating, Ventilation and Air Conditioning) installation must comply with the 1993 B

You must include the following with you application:

- 1) A Copy of Your Deed or Purchase and Sale Agreement
- 2) A Copy of your Construction Contract, if available
- 3) A Plot Plan (Sample Attached)

If there is expansion to the structure, a complete plot plan (Site Plan) must include:

- The shape and dimension of the lot, all existing buildings (if any), the proposed structure and the property lines. Structures include decks porches, a bow windows cantilever sections and roof overhangs, as well as, sheds, pools, garages and any other accessory structures.
- Scale and required zoning district setbacks

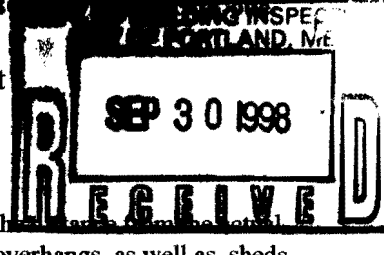

SITE REVIEW EXEMPTED PER KANDI TALBOT 9/30/98

4) Building Plans (Sample Attached)

- A complete set of construction drawings showing all of the following elements of construction:
- Cross Sections w/Framing details (including porches, decks w/ railings, and accessory structures)
 - Floor Plans & Elevations
 - Window and door schedules
 - Foundation plans with required drainage and dampproofing
 - Electrical and plumbing layout. Mechanical drawings for any specialized equipment such as furnaces, chimneys, gas equipment, HVAC equipment (air handling) or other types of work that may require special review must be included.

Certification

I hereby certify that I am the Owner of record of the named property, or that the proposed work is authorized by the owner of record and that I have been authorized by the owner to make this application as his/her authorized agent. I agree to conform to all applicable laws of this jurisdiction. In addition, if a permit for work described in this application is issued, I certify that the Code Official's authorized representative shall have the authority to enter all areas covered by this permit at any reasonable hour to enforce the provisions of the codes applicable to this permit.

Signature of applicant: <u>[Signature]</u> M/M	Date: <u>9/30/98</u>
--	----------------------

Building Permit Fee: \$25.00 for the 1st \$1000 cost plus \$5.00 per \$1,000.00 construction cost thereafter.
O:\INSP\CORRESP\MNUGENT\APADSFD.WPD

ST

FLASHING
(GAP)

APPROX. ABOVE R

Edge

SEE ATTACHED

Note: Common wall behind chimney to be covered with 5/8" SHEET PILING ON THE SIDE. LINE FORM BOARD INSULATION BETWEEN STUDS THEN COVERED WITH 5/8" SHEET PILING.

18" H. High ALUMINUM REG.

CONSTRUCTION 1 1/2" SQUARE CEMENT BLOCKS

SINGLE FLUE 8" X 8" TILE.

Clean Out Door

A SIDE

Wall Furnace. A self-contained, vented appliance complete with grilles or equivalent, designed for incorporation in or permanent attachment to the structure of a building, manufactured home, or recreational vehicle, and furnishing heated air directly into the space to be heated through openings in the casing. Such appliances should not be provided with duct extensions beyond the vertical and horizontal limits of the casing proper, except that boots not exceeding 10 in. (254 mm) beyond the horizontal of the casing for extension through walls of nominal thickness may be permitted. Where provided, such boots should be supplied by the manufacturer as an integral part of the appliance. This definition excludes floor furnaces, unit heaters, and central furnaces.

Fan-Type Wall Furnace. A wall furnace equipped with a fan for the circulation of air.

Gravity-Type Wall Furnace. A wall furnace dependent on the circulation of air by gravity.

Wall Protector (Shield). Noncombustible surfacing applied to a wall area for the purpose of reducing the clearance between the wall and a heat-producing appliance.

Wash. A slight slope or beveled edge on the top surface of a chimney designed to shed water away from the flue liner.

Water Heater. An indirect-fired fuel-burning or electrically heated appliance for heating water to a temperature not more than 200°F (93°C), having an input not greater than 200,000 Btu or (58.6 kW/hr), and a water-containing capacity not exceeding 120 U.S. gal (454 L).

Wythe. Where referring to masonry chimneys, a course, a thickness, or a continuous vertical section of masonry separating flues in a chimney.

1-6 Dimensions. Where used to describe building construction components, all minimum dimensions specified in this standard are actual unless otherwise stated. Nominal dimensions shall be permitted to vary from their specified dimensions by no more than 1/2 in. (12.7 mm).

1-7 Draft.

1-7.1 Minimum Performance. A chimney or vent shall be so designed and constructed to develop a flow sufficient to remove completely all flue or vent gases to the outside atmosphere. The venting system shall satisfy the draft requirements of the connected appliance(s) in accordance with the equipment manufacturers' instructions or the *ASHRAE Handbook, HVAC Systems and Equipment*, Chapter 31.

1-7.2 Mechanical Draft Systems. A mechanical draft system of either forced or induced draft design shall be permitted to be used to increase draft or capacity. Where a mechanical draft system is installed, provision shall be made to prevent the flow of fuel to an automatically fired appliance(s) when that system is not operating.

1-7.3 Chimneys serving incinerators, or other process equipment where the combustion process cannot be stopped

completely by fuel shutoff alone, shall be sized for natural draft conditions. Where air pollution control devices or other devices in the chimney system require a mechanical draft system, the chimney system shall be so arranged that, upon a power failure, the natural draft chimney alone can satisfactorily remove the products of combustion until the combustible material is completely consumed.

1-7.4 Forced draft systems and all portions of induced draft systems under positive pressure during operation shall be designed and installed to be gastight or to prevent the leakage of combustion products into a building.

1-7.5 Vent connectors serving appliances vented by natural draft shall not be connected into any portion of mechanical draft systems operating under positive pressure.

1-8 Termination (Height).

1-8.1 Chimneys and vents shall terminate above the roof level in accordance with the requirements of this standard. [See Figures 1-8.1(a) and (b).]

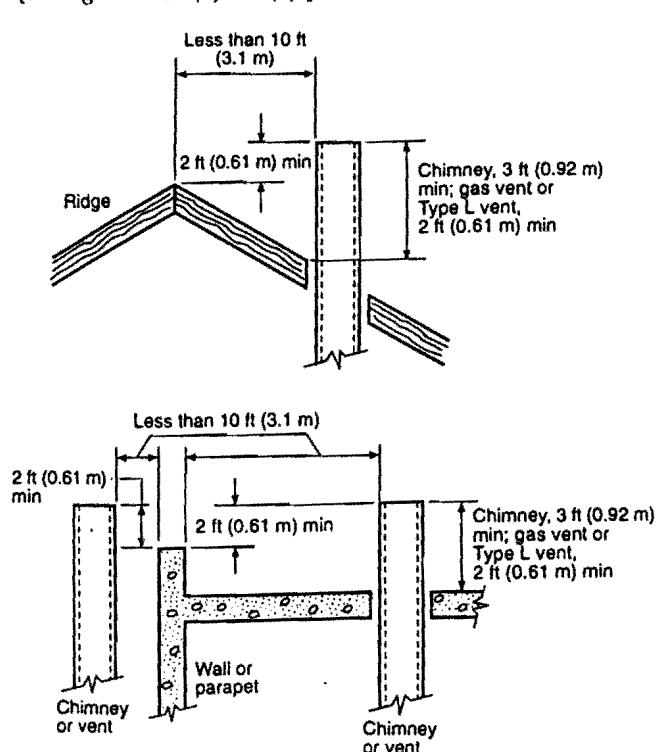

Termination less than 10 ft (3.1 m) from ridge, wall, or parapet

Figure 1-8.1(a) Chimney or vent termination [less than 10 ft (3.1 m)].

1-8.1.1 Masonry chimneys shall extend above the highest point at which they pass through the roof of a building by at least the distance specified in Table 4-2, Column VI, and

INFO. ONLY
 Copy sent to
 Doug Sedeliger
 also discussed
 w/ Jimmy
 10/14/98

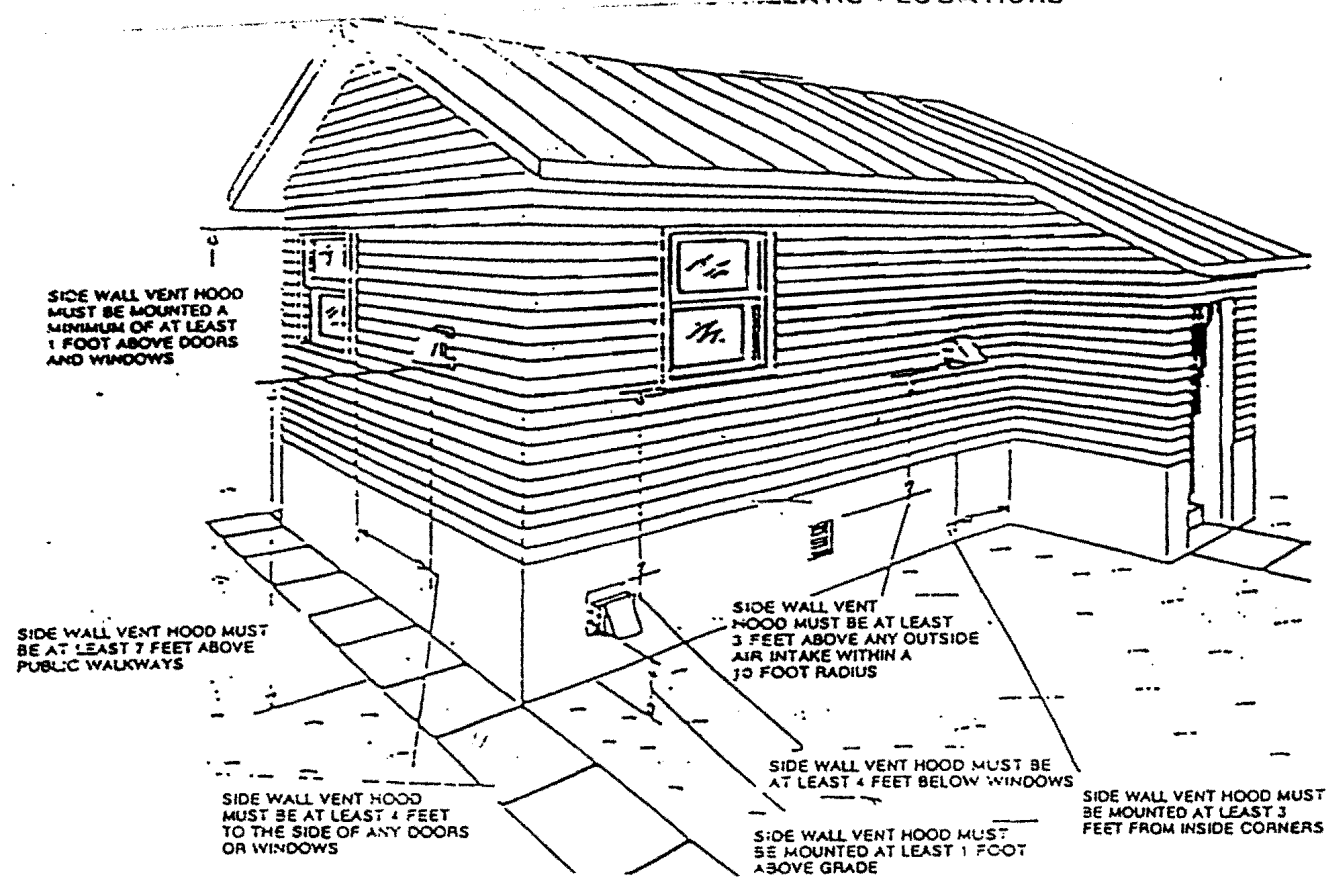

CAUTION: The power venter should never be installed with the venter motor in the vertical position, because this position traps heat in the venter housing and this WILL cause damage to the motor. The venter should be installed with at least a 90 deg. elbow off the heating appliance. For maximum bearing life, install in the horizontal position. For a typical installation See Diagram A.

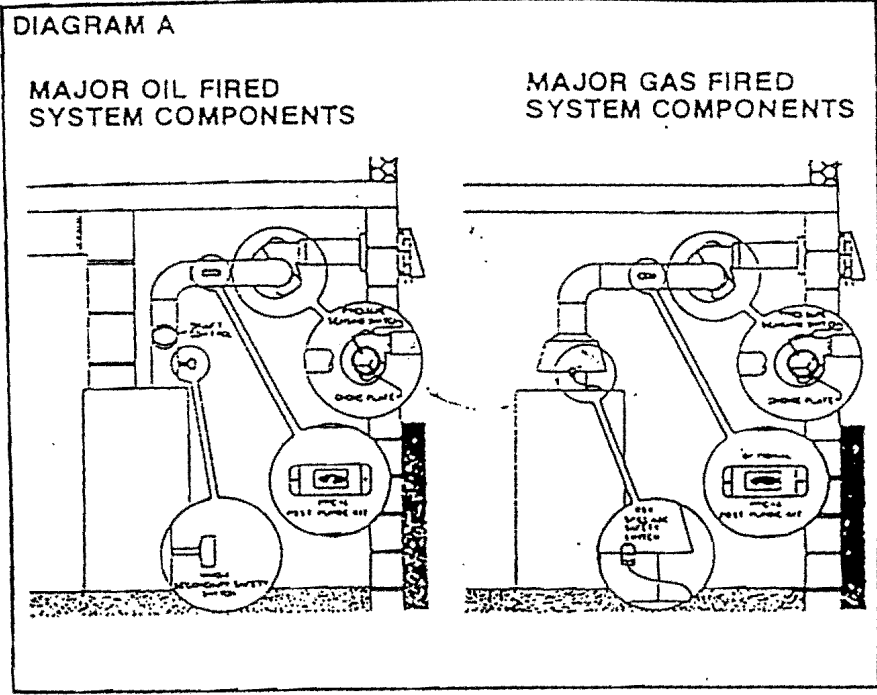

Copy sent to Guy Seeliger also discussed w/ him

*7/20/04 15:00
4
10*

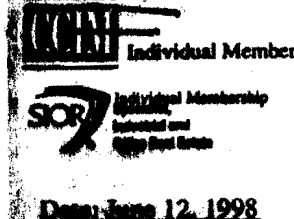

**CONTRACT
FOR THE SALE OF REAL ESTATE**

One Canal Plaza, Portland, ME 04101
(207) 772-1333

Date: June 12, 1998

RECEIVED OF: Gary Sidelinger and/or Assigns whose mailing address is 15 Hemlock Drive, Cumberland, Maine, hereinafter called the Purchaser(s), the sum of Ten Thousand and 00/100 Dollars (\$10,000.00 upon acceptance) as earnest money deposit and in part payment of the purchase price of the following described real estate, situated in the municipality of Portland, County of Cumberland, State of Maine and located at 65 Lambert Street, Portland, Maine being all the property owned by the Seller(s) at the above address, and described as said County's Registry of Deeds Book 6261, Page 47 and further described as: 38,679 +/- s.f. lot improved with a sixteen (16) unit residential complex known as Tara Apartments, referenced by the City of Portland Assessors office as Map 382A, Block B, Lot 1 upon the terms and conditions indicated below:

1. **PERSONAL PROPERTY:** The following items of personal property are included in this sale (if applicable): stoves and refrigerators
2. **PURCHASE PRICE:** The TOTAL purchase price being Six Hundred Sixty Two Thousand Five Hundred and 00/100 Dollars (\$662,500.00) to be paid as follows: \$10,000.00 upon acceptance, the balance to be paid in cash or certified check at closing \$666,000.00
3. **EARNEST MONEY/ACCEPTANCE:** The Boulos Company shall hold said earnest money in a non-interest bearing account and act as Escrow Agent until closing; this offer shall be valid until June 15, 1998 at 5:00 PM; and, in the event of the Seller's non-acceptance, this earnest money shall be returned promptly to the Purchaser(s).
4. **TITLE:** That a deed, conveying good and merchantable marketable title in accordance with standards adopted by the Maine Bar Association shall be delivered to the Purchaser(s) and this transaction shall be closed and the Purchaser(s) shall pay the balance due and execute all necessary papers on or before August 15, 1998. If Seller(s) is unable to convey in accordance with the provisions of this paragraph, then the Seller(s) shall have a reasonable time period, not to exceed thirty (30) days, from the time the Seller(s) receives written notice of the defect, unless otherwise agreed to by both parties, to remedy the title, after which time, if such defect is not corrected so that there is merchantable title, the Purchaser(s) may, within fifteen (15) days thereafter, at Purchaser's option, withdraw said earnest money and neither party shall have any further obligation hereunder. If the Purchaser(s) does not withdraw the earnest money and declare the contract void within the period set forth above, the Purchaser(s) shall have waived the right to object to title. The Seller(s) hereby agrees to make a good-faith effort to cure any title defect during such period.
5. **DEED:** That the property shall be conveyed by a warranty deed, and shall be free and clear of all encumbrances except building and zoning restrictions of record, restrictive covenants and conditions of record and usual public utilities servicing the property and shall be subject to applicable land use and building laws and regulations.
6. **POSSESSION /OCCUPANCY:** Possession/occupancy of premises shall be given to Purchaser(s) immediately at closing, subject to any leases, unless otherwise agreed by both parties in writing.
7. **LEASES/TENANT SECURITY DEPOSITS:** Seller(s) agrees to transfer at closing to Purchaser(s) all Seller(s)' rights under the current leases to the property and all security deposits held by Seller(s) pursuant to said leases.
8. **RISK OF LOSS:** Until the transfer of title, the risk of loss or damage to said premises by fire or otherwise, is assumed by the Seller(s) unless otherwise agreed in writing. Said premises shall then be in substantially the same condition as at present, excepting reasonable use and wear.
9. **PRORATIONS:** The following items shall be prorated as of the date of closing:
 - a. Real Estate Taxes based on the municipality's tax year. Seller is responsible for any unpaid taxes for prior years.
 - b. Fuel
 - c. Water
 Metered utilities, such as water and sewer, shall be paid by Seller(s) through the date of closing. Purchaser(s) and Seller(s) shall each pay its transfer tax as required by the State of Maine.
10. **INSPECTIONS:** The Purchaser(s) is encouraged to seek information from professionals regarding any specific issue of concern. Purchaser(s) acknowledges receipt of disclosure form attached hereto. The Agent makes no warranties regarding the condition, permitted use or value of the Seller's real or personal property. This Contract is subject to the following inspections, with the results being satisfactory to the Purchaser(s):

Page 1 of 3

Seen and agreed to by _____ Seller(s) _____ Purchaser(s)

* Note: The book + page number of the deed must be inserted prior to acceptance on this contract shall be null + void. 6/18/98

INSPECTION	RESULTS REPORTED		TYPE OF INSPECTION	RESULTS REPORTED	
	YES	NO		YES	NO
a. General Building	<input checked="" type="checkbox"/>	<input type="checkbox"/>	g. Lead Paint	<input checked="" type="checkbox"/>	<input type="checkbox"/>
b. Waste Disposal	<input checked="" type="checkbox"/>	<input type="checkbox"/>	h. Pests	<input checked="" type="checkbox"/>	<input type="checkbox"/>
c. Air Quality	<input checked="" type="checkbox"/>	<input type="checkbox"/>	i. ADA	<input checked="" type="checkbox"/>	<input type="checkbox"/>
d. Radon Air Quality	<input checked="" type="checkbox"/>	<input type="checkbox"/>	j. Wetlands	<input checked="" type="checkbox"/>	<input type="checkbox"/>
e. Radon Water Quality	<input checked="" type="checkbox"/>	<input type="checkbox"/>	k. Environmental Scan	<input checked="" type="checkbox"/>	<input type="checkbox"/>
f. Asbestos Air Quality	<input checked="" type="checkbox"/>	<input type="checkbox"/>	l. Other	<input type="checkbox"/>	<input type="checkbox"/>

The use of days is intended to mean from the effective date of this Contract. All inspections will be done by inspectors chosen and paid for by the Purchaser(s). If the result of any inspection or other condition specified herein is unsatisfactory to the Purchaser(s), Purchaser(s) may declare the Contract null and void by notifying Seller(s) in writing within the specified number of days, and any earnest money shall be returned to the Purchaser(s). If the Purchaser(s) does not notify the Seller(s) that an inspection is unsatisfactory within the time period set forth above, this contingency is waived by the Purchaser(s). In the absence of inspection(s) mentioned above, the Purchaser(s) is relying completely upon Purchaser's own opinion as to the condition of the property.

11. FINANCING: This contract is subject to an approved commercial mortgage of 80% of the purchase price, which terms shall include interest rate of 5.25% amortized over no less than 15 years and no more than 1 point.
 - a. If Seller, or Sellers agent, is not notified to the contrary in writing within forty-five (45) days of the effective date of this contract, then this financing condition shall be deemed to have been waived by Purchaser(s).
 - b. The Purchaser(s) is under a good-faith obligation to seek and accept financing on the above-described terms. The Purchaser(s) acknowledges that a breach of this good-faith obligation to seek and accept financing on the above-described terms will be a breach of this Contract.
12. AGENCY DISCLOSURE: The Purchaser(s) and Seller(s) acknowledge that they have been informed that the Selling Licensee is acting as a Seller's agent in this transaction and is representing the Seller(s) and that the Listing Licensee is acting as a Buyer's agent in this transaction and is representing the Seller(s).
13. DEFAULT: If the Purchaser(s) fails to consummate this transaction, Seller(s) shall have the option of either retaining the earnest money as full and complete liquidated damages or pursuing all available legal and equitable remedies. Should Seller(s) elect to retain the earnest money, this Contract shall terminate and neither party shall be under any further obligation hereunder. In the event of default by either party, the Escrow Agent will not return the earnest money to Purchaser(s) or turn over the deposit to the Seller(s) without written releases from both parties.
14. MEDIATION: Any dispute or claim arising out of or relating to this Contract or the premises addressed in this Contract shall be submitted to mediation in accordance with the Maine Residential Real Estate Mediation Rules of the American Arbitration Association. This clause shall survive the closing of this transaction for two (2) years thereafter.
15. PRIOR STATEMENTS: Any verbal presentations, statements and agreements are not valid unless contained herein. This Contract completely expresses the obligations of the parties. This is a Maine contract and shall be construed according to the laws of Maine.
16. HEIRS/ASSIGNS: This Contract shall extend to and be obligatory upon heirs, personal representatives, successors, and assigns of the respective parties.
17. COUNTERPARTS: This Contract may be signed on any number of identical counterparts, including telefacsimile copies, with the same binding effect as if the signatures were on one instrument. Original or telefacsimiled signatures are binding.
18. EFFECTIVE DATE: This Contract is a binding contract when signed by both Seller(s) and Purchaser(s) and when that fact has been communicated to all parties or to their agents. Time is of the essence of this Contract.
19. REVIEW OF LEASES AND INCOME AND EXPENSE INFORMATION: The Seller(s) shall provide the Purchaser(s) with copies of all leases and income & expense information regarding the subject property within three (3) days of the effective date of this contract. Purchaser(s) shall have ten business (10) days from such delivery to review leases and income & expense information regarding the property. If the result of the review is unsatisfactory to the Purchaser(s), Purchaser(s) may declare the Contract null and void by notifying the Seller(s) in writing within the specified number of days set forth above, and any earnest money shall be returned to the Purchaser(s). If the Purchaser(s) does not notify the Seller(s) that the review is unsatisfactory within the time period set forth above, this contingency is waived by the Purchaser(s).
20. Seller(s) and Purchaser(s) acknowledge receipt of the Maine Real Estate Commission Disclosure of Agency Relationship Form (Form #1).
21. ADDENDA: This Contract has addenda containing additional terms and conditions: YES NO
22. This contract is contingent upon purchaser obtaining a written evidence satisfactory to the Purchaser at his sole determination that gas or propane can be supplied to the premises and that the existing electric heating system can be converted to a gas fired heating system at a cost acceptable to the Purchaser. This contingency will exist for 15 days from the effective date of this Contract. In the event Seller is not notified to the contrary this condition will expire at the end of the above referenced term. This Contingency may be waived by the purchaser at his sole discretion.
23. Purchaser will be supplied with a certified rent roll within 3 days of the effective date of this Contract.

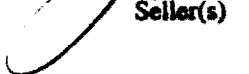
Page 2 of 3
 Seen and agreed to:  Seller(s)  Purchaser(s)

THIS CONTRACT IS TO BE RECEIVED BY ALL PARTIES AND, BY SIGNATURE, RECEIPT OF A COPY IS HEREBY ACKNOWLEDGED. IF NOT FULLY UNDERSTOOD CONSULT AN ATTORNEY.

I acknowledge that the laws of the State of Maine provide that every buyer of real property located in Maine must withhold a withholding tax equal to 2% of the consideration unless the Seller(s) furnishes to the Buyer(s) a certificate by the Seller(s) stating, under penalty of perjury, that Seller(s) is/are a resident of Maine or the transfer is otherwise exempt from withholding.

[Signature]
Purchaser
Gary Sidelinger and/or Assigns
Name/Title

6/12/98
Date
007-24-3911
Soc. Sec. # or Tax I.D. #

Purchaser
Name/Title

Date
Soc. Sec. # or Tax I.D. #

The Seller(s) accepts the offer and agrees to deliver the above-mentioned property at the price and upon the terms and conditions set forth above and agrees to pay the Broker the commission for services herein according to the Listing Agreement or if there is no Listing Agreement the sum of: _____. The obligation to pay said commission or sum shall survive the closing of this transaction. Seller agrees that Broker may apply any deposit(s) received in connection with the sale of the Property toward commissions due and payable under this Agreement. If the earnest money is forfeited by Purchaser(s), it shall be evenly distributed between the Broker and the Seller(s), provided, however, that Broker's portion shall not exceed the full amount of the commission specified. In the event the Seller(s) defaults on its obligations hereunder, The Boulos Company shall be entitled to costs of collection, including reasonable attorneys' fees.

Signed this 17 day of JUNE, 1998. Effective date of Contract: 6/17, 1998.

The Listing Licensee is Dan Greenstein of The Boulos Company (Company).
The Selling Licensee is Dan Greenstein of The Boulos Company (Company).

[Signature]
Name/Title

June 17, 1998
Date
005-28-5516
Soc. Sec. # or Tax I.D. #

Name/Title

Date
Soc. Sec. # or Tax I.D. #

Accepted and refused on _____, 19____, _____ Seller

Page 2 of 3
Rev. 3/88

**BOULOS
COMPANY**

The Boulos Company • One Canal Plaza • Portland • Maine • 04101
fax: (207) 871-1288 • phone: (207) 772-1333 • E-mail: info@boulos.com

FACSIMILE COVER SHEET

Date: July 01, 1998
To: Gary Sidelinger
Phone: 207-772-1849
Fax: 207-772-0428
From: Boulos Company
Daniel Greenstein
Phone: 207-772-1333
Fax: 207-871-1288
Pages: 1

Subject: Tara Apartments

Gary, please sign and return via fax and I'll present to Seller for signature.

NOTICE
The information contained in this communication is confidential and is intended only for the use of the addressee. Unauthorized use, disclosure, distribution or copying is strictly prohibited. If you receive this communication in error, please notify us by telephone immediately at (207) 772-1333 so that we may arrange for the retrieval of the documents as we rest to you.

07/01/98 12:51 TX/BX NO.1339 P.001

**ADDENDUM B
 TO CONTRACT FOR SALE OF REAL ESTATE**
 Located at
**65 LAMBERT STREET
 PORTLAND, MAINE**
 Purchase: GARY SIDELINGER AND/OR ASSIGNS
 Dated: June 12, 1988

The Contract for the above referenced property is amended as follows:

1. The time-frame referenced in paragraph 4 of the Contract for closing the transaction is changed to read "...on or before September 11, 1988."
2. All other conditions of the Contract are to remain "as-is".

SEEN AND AGREED TO:

GARY SIDELINGER AND/OR ASSIGNS, Purchaser

BY: [Signature] DATE: 8/11/98

JOHN MARR, SR., Seller

BY: [Signature] DATE: 8-7-98
 FOR: John Marr

Post-It* Fax Note	7671	Date	8/11	# of pages
To	Lee Hamilton	From	Jim Brown	
Co./Dept.	Sideline - 10/11	Co.	RFC	
Phone #	772-1829	Phone #		
Fax #	772-5426	Fax #		

08/07/98 11:25 TX/RX NO.1482 P.002

08/11/98 13:48 TX/RX NO.1475 P.001

9/23/98

CONSTRUCTION OF FURNACE ROOM

THIS ROOM WILL BE WOOD FRAMED WITH SHEATHING AND VINYL SIDED.

THE FOUNDATION WILL BE A CEMENT SLAB APPROXIMATELY 6 INCHES THICK AND REINFORCED WITH REBAR.

THE WALLS WILL BE FRAMED WITH 2 X 4 LUMBER.

THE ROOF WILL HAVE A 6" PITCH PER FOOT TO MATCH THE PITCH OF THE EXISTING BUILDING. THE ROOF WILL BE SHINGLED WITH COMPOSITION SHINGLES.

THE ENTRY TO THIS SHED WILL BE THROUGH THE FRONT OF THE BUILDING THROUGH DOUBLE DOORS MEASURING 6' X 6'8".

THE CEILING AND AJOINING WALL TO THE EXISTING STRUCTURE WILL BE COVERED WITH A DOUBLE LAYER OF 5/8" SHEETROCK. THE OTHER INTERIOR WALLS OF THIS BUILDING WILL BE COVERED WITH 5/8" SHEETROCK.

THE AIR VENTILATION AT THE TOP OF THE BUILDING WILL BE THROUGH SCREENING IN THE EVES EQUAL TO A TOTAL OF 192 SQ. INCHES AND A POWERED LOUVER AT THE BOTTOM OF THE EXTERIOR WALL EQUAL TO 192 SQ. INCHES.

REGARDS:

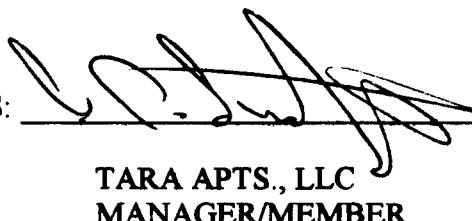

TARA APTS., LLC
MANAGER/MEMBER

Building

6" - 3000*
Slab

3/8 Rebar
1' foot
Each
Way

Foundations for oil shed
SAME EXCEPT 6x6 AND
NO CHIMNEY "C".

C

Base for Chimney

20" x 20"
4' Deep - 8' x 8' slab

A-B-C-D

Part of concrete

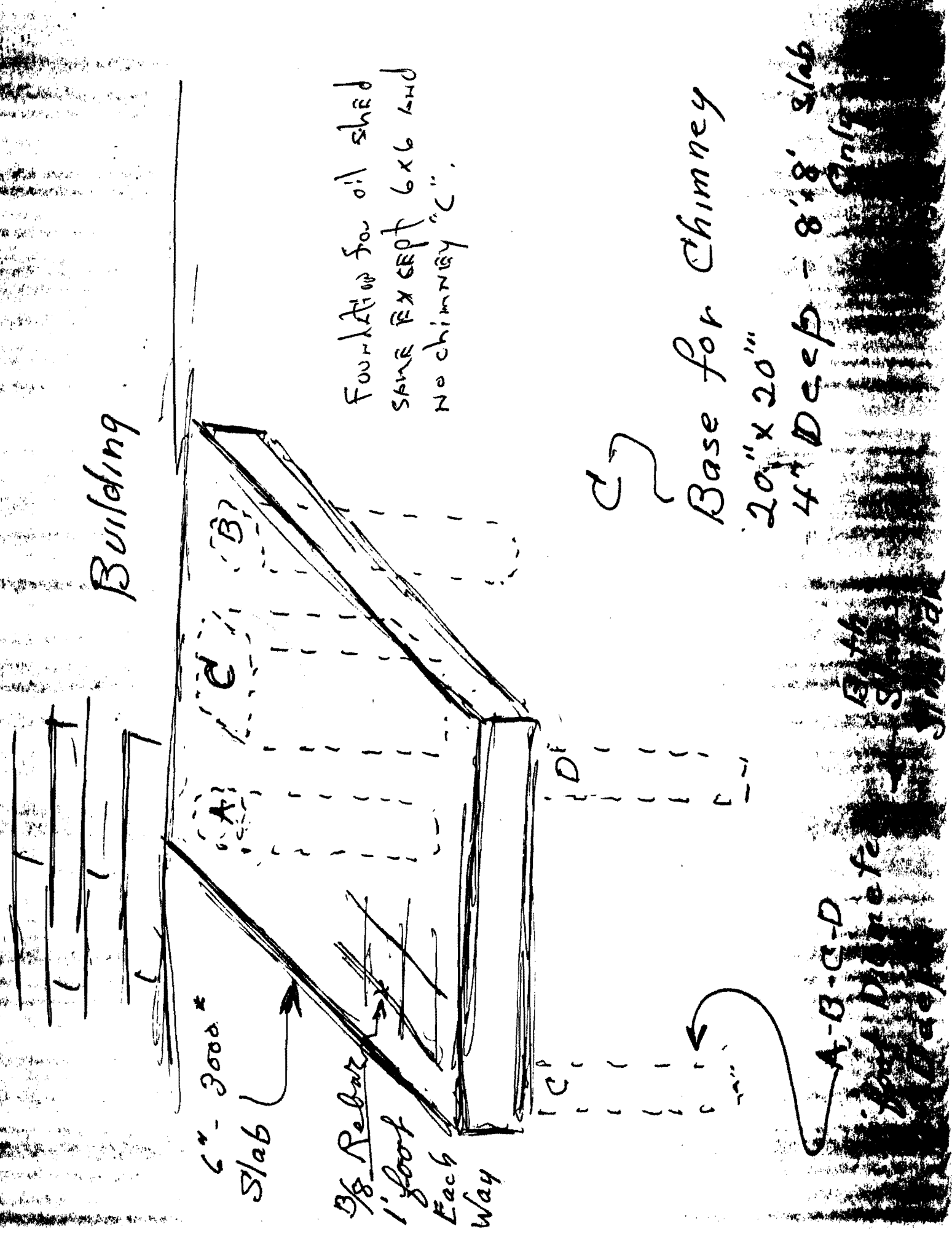

FURNACE ROOM

Pitch 6" per ft.

2 Layers 5/8" Sheetrock

2 Layers 5/8" Sheetrock

Studs 16" on center

Powered Vent 1" x 4"

GA Siderliner

1 5/8" Equals 6"

Building Sheathed with 1/2" Plywood.

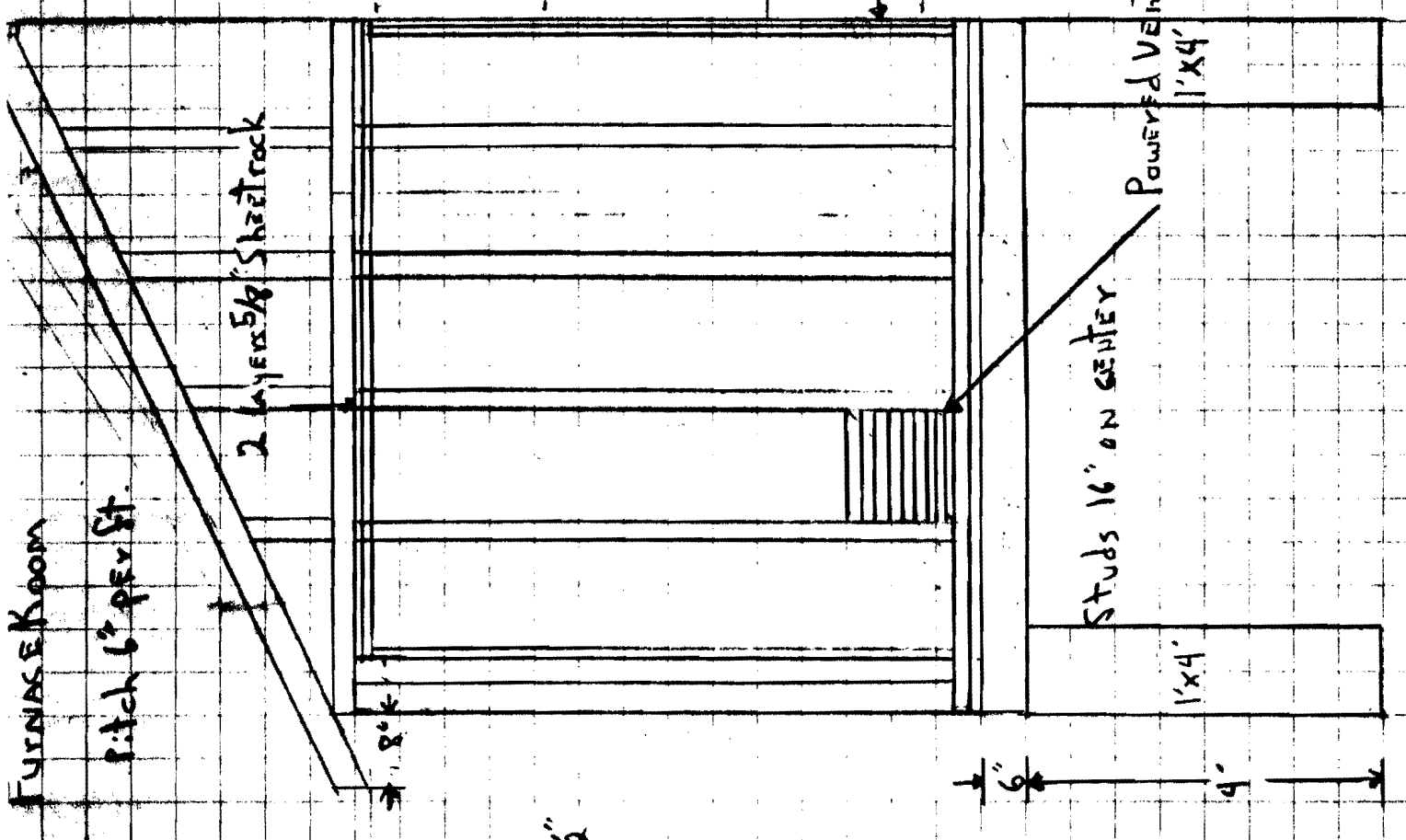

9/23/18

FURNACE ROOM

TARA APTS LLC
65 LAMBERT ST

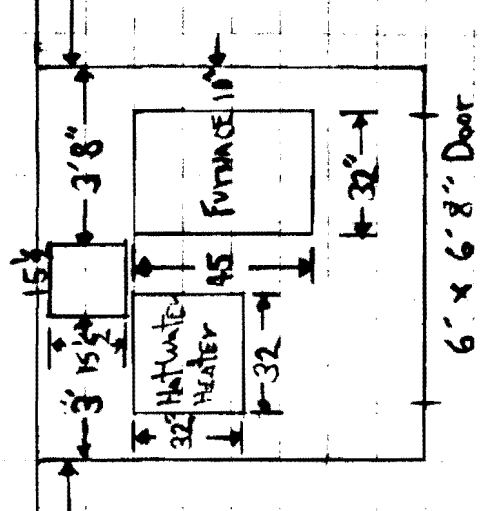

Patio

Patio

[Signature]

TARA APTS LLC
MANAGER/MEMBER

AIRSPACE ROOM

MINUTE

RUSTERS 16" ON CENTER, 2x6"

REFLECTS OVERHANG 8" TO BE SCREENED FOR VENTILATION - IN EXCESS OF 192 SQ. INCHES (REQUIRED AREA 499 4/80 SQ. INCHES).

ROOF AND WALLS SHEATHED WITH 1/2" PLYWOOD.

CILL IS BOLTED TO FOUNDATION

(FOUNDATION 6" THICK REINFORCED WITH 3/8" REBAR 1FT EACH WAY)

GA. SIDE WALK 159 = 6"

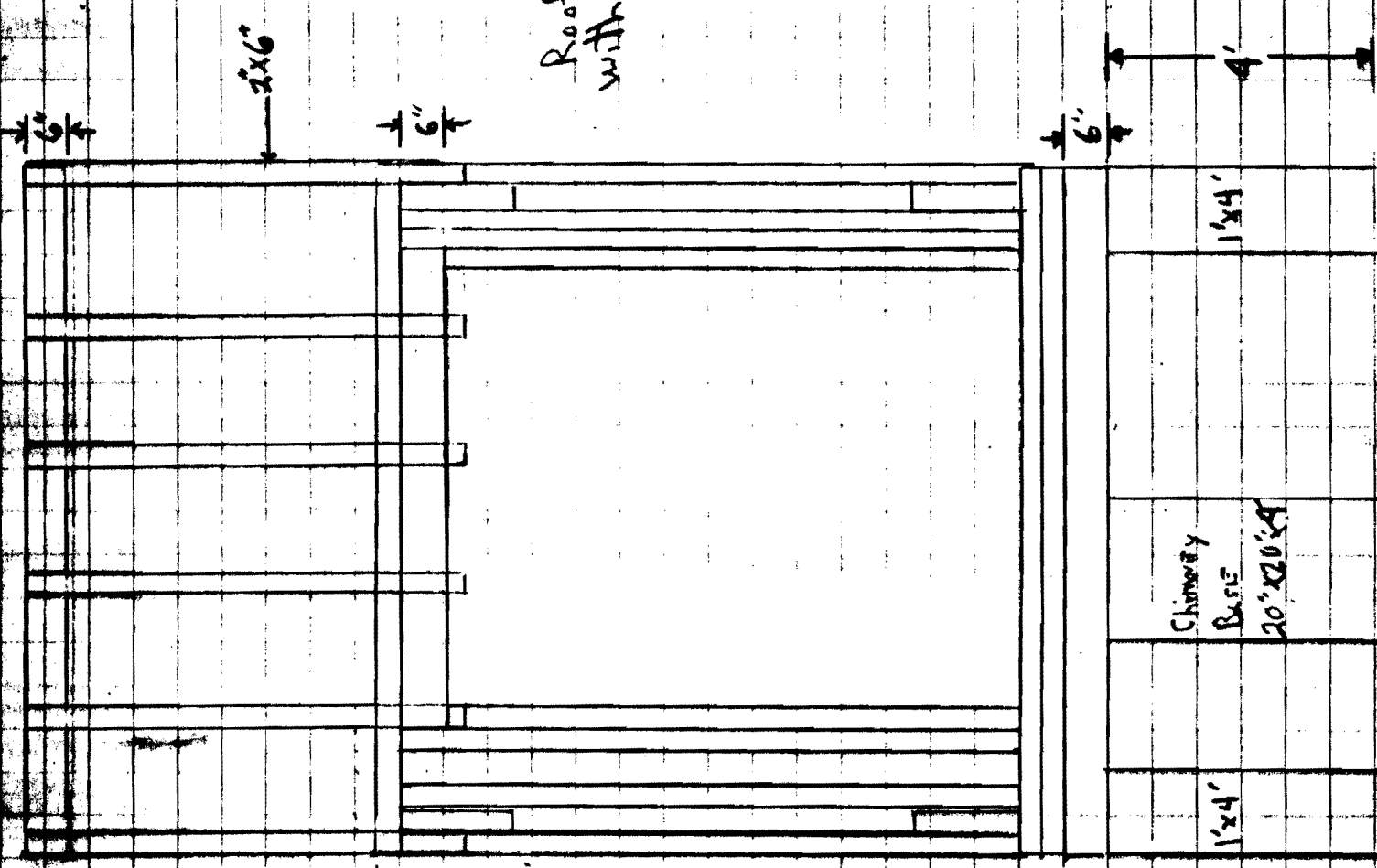

2x6"

6"

6"

4"

1 1/4"

Chimney Base 20" x 20" x 8"

1 1/4"

9/23/98

CONSTRUCTION OF OIL TANK ROOM

THIS ROOM WILL BE WOOD FRAMED WITH SHEATHING AND VINYL SIDED.

THE FOUNDATION WILL BE A CEMENT SLAB APPROXIMATELY 6 INCHES THICK AND REINFORCED WITH REBAR.

THE WALLS WILL BE FRAMED WITH 2 X 4 LUMBER.

THE ROOF WILL HAVE A 6" PITCH PER FOOT TO MATCH THE PITCH OF THE EXISTING BUILDING. THE ROOF WILL BE SHINGLED WITH COMPOSITION SHINGLES.

THE ENTRY TO THIS SHED WILL BE THROUGH A 3'0" X 6'8" DOOR ON THE END OF THE SHED TOWARD THE FURNACE ROOM.

THE INTERIOR WALLS AND CEILING OF THIS BUILDING WILL BE COVERED WITH 5/8" SHEETROCK. THE WALLS WILL ALSO BE INSULATED TO HELP KEEP THE OIL AS WARM AS POSSIBLE.

THE AIR VENTILATION AT THE TOP OF THE BUILDING WILL BE THROUGH SCREENING IN THE EVES EQUAL TO A TOTAL OF APPROXIMATELY 192 SQ. INCHES.

REGARDS:



TARA APTS., LLC
MANAGER/MEMBER

OIA Tank Room

VP/MS

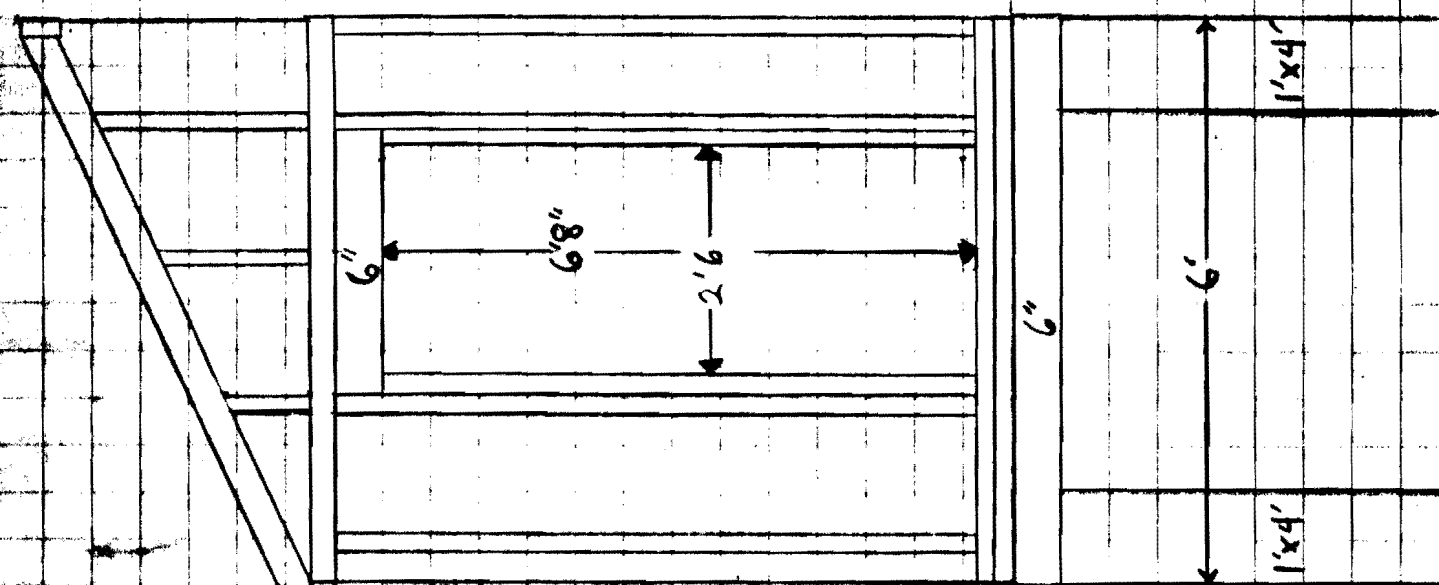

Rafter overhang 8" to be screened for ventilation. → 8"

Studs 16" ON CENTER.
Roof and walls sheathed in 1/2" plywood.
Roof rafters 2" x 6".

Cill bolted to foundation.

Foundation 6" thick reinforced with 3/8" rebar 1 ft. each way.

G.A. Sidelinger
159 Equale 6"

OUTSIDE SCOP

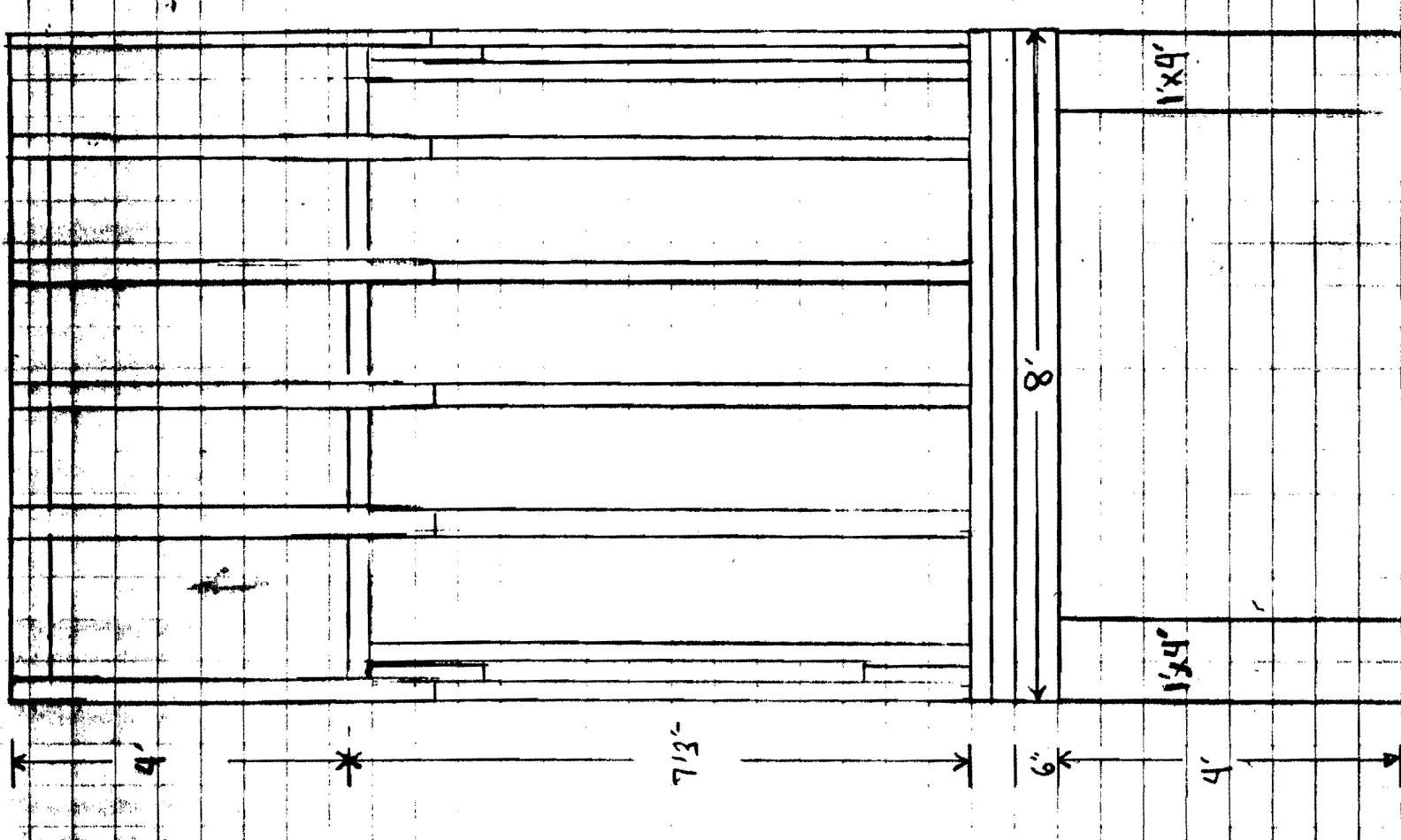

Rafters 2'x6"

Roof and walls sheathed with 1/2" plywood.

Studs 16" ON CENTER

G.A. Sidelinger
159' = 6"

912398

Oil Tank Room TARA APTS, LLC
65 Lambert St

11/6/00
Dor
OIL TANK

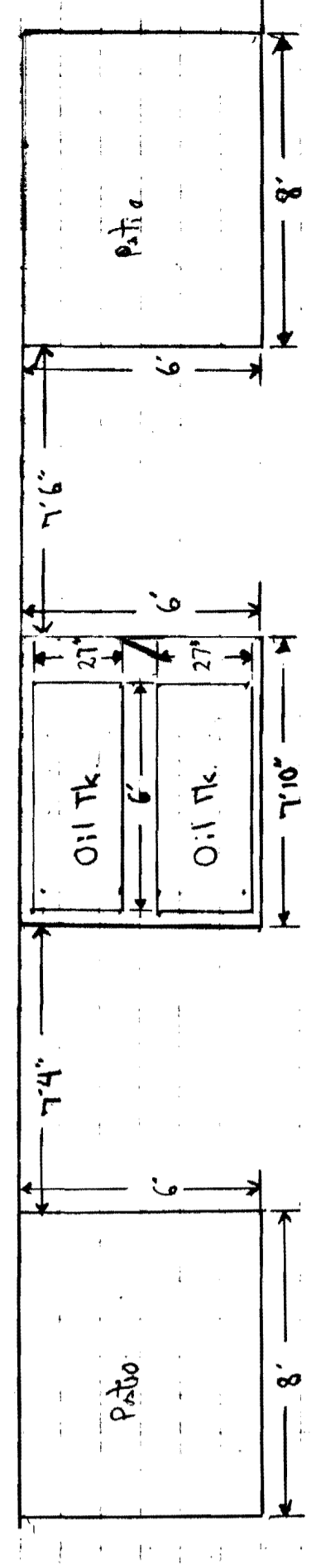

Oil Tks 27" x 6'

TARA APTS, LLC
MANAGER/MEMBER

BY ORDER OF THE ENGINEER

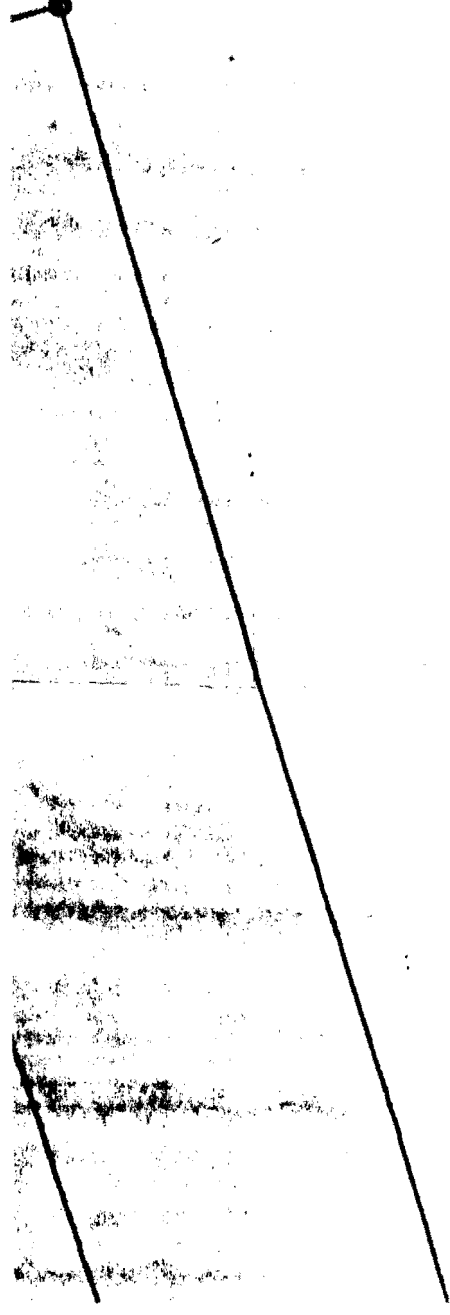

N/F
RALPH W. POORE
BOOK 4664, PAGE 297

Considered side 22'7" shown
Require → 17' - 22'7" shown

N 78°41'10" E
358.08' (change 358.40')

22'7"

Tree Removal (17' x 17')

