

DISPLAY THIS CARD ON PRINCIPAL FRONTAGE OF WORK



CITY OF PORTLAND

BUILDING PERMIT

This is to certify that Ballpark Drive Development LLC Located At 11 BALLPARK DR

Job ID: 2012-04-3739-SF

CBL: 371-A-046-001

has permission to Build a One Story Single Family Residence with an attached Garage.

provided that the person or persons, firm or corporation accepting this permit shall comply with all of the provisions of the Statues of Maine and of the Ordinances of the City of Portland regulating the construction, maintenance and use of the buildings and structures, and of the application on file in the department.

Notification of inspection and written permission procured before this building or part thereof is lathed or otherwise closed-in. 48 HOUR NOTICE IS REQUIRED.

A final inspection must be completed by owner before this building or part thereof is occupied. If a certificate of occupancy is required, it must be

Fire Prevention Officer

 04/30/2012
Code Enforcement Officer / Plan Reviewer

THIS CARD MUST BE POSTED ON THE STREET SIDE OF THE PROPERTY

PENALTY FOR REMOVING THIS CARD



Certificate of Occupancy



CITY OF PORTLAND, MAINE
Department of Planning and Urban Development
Building Inspections Division

Location: 11 BALLPARK DR

CBL: 371- A-046-001

Issued to: BALLPARK DRIVE DEVELOPMENT LLC

Date Issued: 8/21/2012

This is to certify that the building, premises, or part thereof, at the above location, built-altered-changed as to use under Building Permit No. 2012-04-3739-SF, has had a final inspection, has been found to conform substantially to the requirements of the Building Code and the Land Use Code of the City of Portland, and is hereby approved for occupancy or use, limited or otherwise, as indicated below.

PORTION OF BUILDING OR PREMISES

ENTIRE

APPROVED OCCUPANCY

USE GROUP R3
SINGLE FAMILY
TYPE 5B
IBC 2009

Approved:

8/21/2012

(Date)

Inspector

Inspections Division Director

Notice: This certificate identifies the legal use of the building or premises, and ought to be transferred from owner to owner upon the sale of the property.

BUILDING PERMIT INSPECTION PROCEDURES

Please call 874-8703 or 874-8693 (ONLY)

or email: buildinginspections@portlandmaine.gov

With the issuance of this permit, the owner, builder or their designee is required to provide adequate notice to the city of Portland Inspections Services for the following inspections. Appointments must be requested 48 to 72 hours in advance of the required inspection. The inspection date will need to be confirmed by this office.

- **Please read the conditions of approval that is attached to this permit!! Contact this office if you have any questions.**
- **Permits expire in 6 months. If the project is not started or ceases for 6 months.**
- **If the inspection requirements are not followed as stated below additional fees may be incurred due to the issuance of a "Stop Work Order" and subsequent release to continue.**
 1. Footings/Setbacks prior to pouring concrete
 2. Foundation prior to Backfill
 3. Close In Elec/Plmb/Frame prior to insulate or gypsum
 4. Insullation prior to Close-In
 5. Final Inspection/ Certificate of Occupancy

The project cannot move to the next phase prior to the required inspection and approval to continue, REGARDLESS OF THE NOTICE OF CIRCUMSTANCES.

IF THE PERMIT REQUIRES A CERTIFICATE OF OCCUPANCY, IT MUST BE PAID FOR AND ISSUED TO THE OWNER OR DESIGNEE BEFORE THE SPACE MAY BE OCCUPIED.



PORTLAND MAINE

Strengthening a Remarkable City, Building a Community for Life • www.portlandmaine.gov

Acting Director of Planning and Urban Development
Gregory Mitchell

Job ID: 2012-04-3739-SF

Located At: 11 BALLPARK DR

CBL: 371- A-046-001

Conditions of Approval:

Zoning

1. This permit is being approved on the basis of plans submitted. Any deviations shall require a separate approval before starting that work.
2. As discussed during the review process, the property must be clearly identified prior to pouring concrete and compliance with the required setbacks must be established. Due to the proximity of the setbacks of the proposed structure, it may be required to be located by a surveyor.
3. This property shall remain a single family dwelling. Any change of use shall require a separate permit application for review and approval.

Fire

1. All construction shall comply with City Code Chapter 10.
2. A sprinkler system shall be installed.
3. A separate no fee One- or Two-family Fire Sprinkler Permit is required.
4. All smoke detectors and smoke alarms shall be photoelectric.
5. Hardwired Carbon Monoxide alarms with battery back up are required on each floor.
- 6. Sprinkler requirements**
7. The sprinkler system shall be installed in accordance with NFPA 13D. A compliance letter is required.
8. All control valves shall be supervised in accordance with NFPA 13D. Pad locks shall only be installed on valves designed to be secured in the open position by pad lock.
9. Application requires State Fire Marshal approval.
10. Install an NFPA 13D automatic sprinkler system.

DRC

1. The Development Review Coordinator reserves the right to require additional lot grading or other drainage improvements as necessary due to field conditions.
2. A street opening permit(s) is required for your site. Please contact Carol Merritt ay 874-8300, ext. 8822. (Only excavators licensed by the City of Portland are eligible.)
3. All damage to sidewalk, curb, street, or public utilities shall be repaired to City of Portland standards prior to issuance of a certificate of occupancy.
4. The Development Review Coordinator (874-8632) must be notified five (5) working days prior to date required for final site inspection. Please make allowances for completion of site plan requirements determined to be incomplete or defective during

- the inspection. This is essential as all site plan requirements must be completed and approved by the Development Review Coordinator prior to issuance of a Certificate of Occupancy. Please schedule any property closing with these requirements in mind.
5. Two (2) City of Portland approved species and size trees must be planted on your street frontage prior to issuance of a Certificate of Occupancy. Applicant must meet with the City Arborist and Development Review Coordinator prior to planting to determine the location of tree planting so as not to be planted in the force main ROW in compliance with the easement deed for this site.
 6. All Site work (final grading, landscaping, loam and seed) must be completed prior to issuance of a certificate of occupancy. A performance guarantee will be required to cover the cost of site work not completed due to seasonal conditions ie., finish grading, loaming, seeding, mulching, installation of street trees, etc. The performance guarantee must be reviewed, approved, and accepted by the Planning Authority prior to the release of a Temporary Certificate of Occupancy.
 7. Trees that are designated to be saved are to be protected during excavation and construction. Tree protection fencing is to be installed around the tree canopy drip line prior to the start of any excavation. Tree protection measures are to be inspected and maintained daily.
 8. Erosion and Sedimentation control shall be established and inspected by the Development Review Coordinator prior to soil disturbance, and shall be done in accordance with Best Management Practices, Maine Department of Environmental Protection Technical and Design Standards and Guidelines. All Erosion and Sedimentation control measures must be inspected and maintained daily.
 9. The limits of allowable clearing shall be clearly marked with flagging or temporary fencing. Absolutely no clearing is to take place within, or encroach into the "do not disturb/no cut" zone. All conditions listed in the approved subdivision plan, as they relate to this lot shall be followed.
 10. A sewer permit is required for your project. Please contact Carol Merritt at 874-8300, ext . 8822. The Wastewater and Drainage section of Public Services must be notified five (5) working days prior to sewer connection to schedule an inspector for your site.

Building

1. Separate permits are required for any electrical: plumbing, sprinkler, fire alarm, HVAC systems, commercial hood exhaust systems and fuel tanks. Separate plans may need to be submitted for approval as a part of this process.
2. Submit specifications for Engineered Trusses prior to construction.
3. Window sills in locations more than 72 inches from finished grade shall be a minimum of 24 inches above the finished floor of the room, unless a window fall prevention devices is installed in accordance with section R612.3.
4. A code compliant emergency escape shall be provided in each bedroom. Window sills in locations more than 72 inches from finished grade shall be a minimum of 24 inches (no higher than 44 inches) above the finished floor of the room, or in compliance with Section R612.4.2 Operation for emergency escape.
5. Stairway headroom shall be not less than 6 feet 8 inches measured vertically from the sloped plane adjoining the tread nosing or from the floor surface of the landing or platform.

6. Ventilation of this space is required per ASRAE 62.2 , 2007 edition; Owner agreed that the "building envelope" insulation will comply with the IECC, 2009 (Maine State Energy Codes).
7. R302.6 Dwelling/garage fire separation. The garage shall be separated as required by Table R302.6. Openings in garage walls shall comply with Section R302.5. This provision does not apply to garage walls that are perpendicular to the adjacent dwelling unit wall.
8. Note: Owner will submit Engineered Lumber Specifications for the 16 foot Garage door opening.

**TABLE R302.6
DWELLING/GARAGE SEPARATION**

SEPARATION	MATERIAL
From the residence and attics	Not less than 1/2 inch gypsum board or equivalent applied to the garage side
From all habitable rooms above the garage	Not less than 5/8-inch Type X gypsum board or equivalent
Structure(s) supporting floor/ceiling assemblies used for separation required by this section	Not less than 1/2 inch gypsum board or equivalent
Garages located less than 3 feet from a dwelling unit on the same lot	Not less than 1/2 inch gypsum board or equivalent applied to the interior side of exterior walls that are within this area

For SI: 1 inch = 25.4 mm, 1 foot = 304.8 mm.

City of Portland, Maine - Building or Use Permit Application

389 Congress Street, 04101 Tel: (207) 874-8703, FAX: (207) 8716

Job No: 2012-04-3739-SF	Date Applied: 4/10/2012	CBL: 371- A-046-001	
Location of Construction: 11 BALLPARK DR	Owner Name: BALLPARK DRIVE DEVELOPMENT LLC	Owner Address: 67 HAVERTY WAY PORTLAND, ME 04103	Phone:
Business Name:	Contractor Name: Vesta Corp	Contractor Address: PO Box 1464 Portland ME 04104	Phone: (207) 879-2217
Lessee/Buyer's Name: Vesta Corp	Phone:	Permit Type: BLDG - Building	Zone: R-2
Past Use: Vacant land	Proposed Use: Build a new one story, single family home with attached two car garage	Cost of Work: 150000.00	CEO District:
		Fire Dept: <input checked="" type="checkbox"/> Approved w/conditions <input type="checkbox"/> Denied <input type="checkbox"/> N/A Signature: <i>Capt. Perrine</i>	Inspection: Use Group: R3 Type: SB IRC, 200? AUBEC Signature: <i>[Signature]</i>
Proposed Project Description: Construct 1500 sf ranch w/garage		Pedestrian Activities District (P.A.D.)	
Permit Taken By:		Zoning Approval	

<p>1. This permit application does not preclude the Applicant(s) from meeting applicable State and Federal Rules.</p> <p>2. Building Permits do not include plumbing, septic or electrical work.</p> <p>3. Building permits are void if work is not started within six (6) months of the date of issuance. False information may invalidate a building permit and stop all work.</p>	Special Zone or Reviews <input type="checkbox"/> Shoreland <i>N/A</i> <input type="checkbox"/> Wetlands <i>N/A</i> <input type="checkbox"/> Flood Zone <i>panel 2-200X</i> <input type="checkbox"/> Subdivision <input checked="" type="checkbox"/> Site Plan <i>Level I Minor Residential</i> <input type="checkbox"/> Maj <input type="checkbox"/> Min <input type="checkbox"/> MM Date: <i>OK w/condition 4/12/12 ABM</i>	Zoning Appeal <input type="checkbox"/> Variance <input type="checkbox"/> Miscellaneous <input type="checkbox"/> Conditional Use <input type="checkbox"/> Interpretation <input type="checkbox"/> Approved <input type="checkbox"/> Denied Date:	Historic Preservation <input type="checkbox"/> Not in Dist or Landmark <input type="checkbox"/> Does not Require Review <input type="checkbox"/> Requires Review <input type="checkbox"/> Approved <input type="checkbox"/> Approved w/Conditions <input type="checkbox"/> Denied Date:
	CERTIFICATION		

I hereby certify that I am the owner of record of the named property, or that the proposed work is authorized by the owner of record and that I have been authorized by the owner to make this application as his authorized agent and I agree to conform to all applicable laws of this jurisdiction. In addition, if a permit for work described in the application is issued, I certify that the code official's authorized representative shall have the authority to enter all areas covered by such permit at any reasonable hour to enforce the provision of the code(s) applicable to such permit.

SIGNATURE OF APPLICANT ADDRESS DATE PHONE

RESPONSIBLE PERSON IN CHARGE OF WORK, TITLE DATE PHONE

5-14-12 DWM Mike 232-8050 Footings OK Survey Markers Found

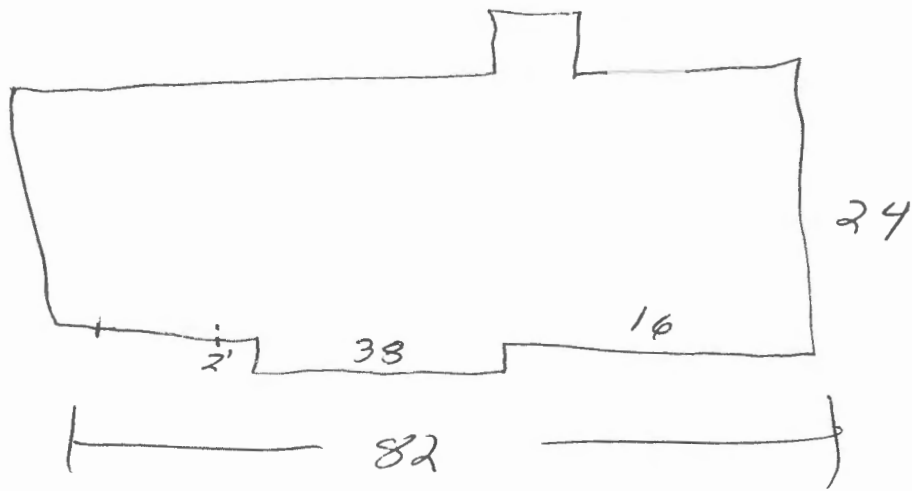

5/21/12 TAR, FF, Drainage ok CF

6-25-12 DWM Michael 232-8050

8-17-12 CF will send pics of rail on back

Pitch, Span, Spacing & Dimension (Table R802.5.1(1) - R 802.5.1 (8)) Roof Rafter; Framing & Connections (Section R802.3 & R802.3.1)	7 $\frac{12}{12}$; 8 $\frac{12}{12}$ e 24" O.C Trusses w/ Horr. Clips	
Sheathing; Floor, Wall and Roof (Table R503.2.1.1(1))	Wall: 7/16 / Floor: 3/4 / Roof: 5/8	Okay
Fastener Schedule (Table R602.3(1) & (2))	"Per Code"	
Private Garage (Section R309) Living Space ? (Above or beside)	None - Above 5/8" Type 'X' Gypsum	
Fire separation (Section R309.2)	(1) "Hour Rated Wall"	
Opening Protection (Section R309.1)	(1) "Hour Rated Door"	Okay
Emergency Escape and Rescue Openings (Section R310)	"4060 Egress Windows"	
Roof Covering (Chapter 9)	40 yr Asphalt	Okay
Safety Glazing (Section R308)		
Attic Access (Section R807)	24" x 36"	
Chimney Clearances/Fire Blocking (Chap. 10)	N/A	
Header Schedule (Section 502.5(1) & (2))	"See A1"	
Energy Efficiency IECC, 2009 R-Factors of Walls, Floors, Ceilings, Building Envelope, U-Factor Fenestration Ventilation of Space per ASRAE 62.2, 2007	Walls: R-21 window: U-.35 Ceiling: R-49 Floor: R-21 / R-30	

<p>Type of Heating System</p>		
<p>Means of Egress (Sec R311 & R312) Basement Number of Stairways Interior Exterior Treads and Risers (Section R311.5.3) Width (Section R311.5.1) Headroom (Section R311.5.2) Guardrails and Handrails (Section R312 & R311.5.6 – R311.5.6.3)</p>	<p>Bulkhead 4 2 - w/ Bulkhead 2 7 1/4" x 10" Tread 3'-1 1/2" 7'-0" 34"</p>	
<p>Carbon Monoxide Alarms (R315) Smoke Alarms (Section R313) Location and Interconnected</p>		
<p>Dwelling Unit Separation (Section R302.3)</p>		
<p>Deck Construction (Section R502.2.1)</p>	<p>2x8" @ 16" o.c. (3) 2x8" Beams</p>	

ONE AND TWO FAMILY	PLAN REVIEW	CHECKLIST
Soil type/Presumptive Load Value (Table R401.4.1) _____		
Component	Submitted Plan	Findings/Revisions/Dates
STRUCTURAL Footing Dimensions/Depth (Table R403.1 & R403.1(1), (Section R403.1 & R403.1.4.1)	8" x 16" Footing w/ 2-#4 Bars 8" Thick Wall / 4" Slab 2 x 4 Keyway	Okay
Foundation Drainage, Fabric, Damp proofing (Section R405 & R406)	w/ Filter Fabric Asphalt Tar	
Ventilation/Access (Section R408.1 & R408.3) Crawls Space ONLY	N/A	
Anchor Bolts/Straps, spacing (Section R403.1.6)	5/8" DIA x 12" Long 3'-0" @ 2 @ corners	Okay
Lally Column Type (Section R407)	3 1/2" DIA Colly 24 x 24" Footing, 12" Thick	Okay
Girder & Header Spans (Table R 502.5(2))	(S) 2 x 10" w/ 5'-6" Max	
Built-Up Wood Center Girder Dimension/Type		
Sill/Band Joist Type & Dimensions	2 x 6" P.T. w/ hooked A307	
First Floor Joist Species Dimensions and Spacing (Table R502.3.1(1) & Table R502.3.1(2))	2 x 10" Floor Joist @ 16" O.C.	
Second Floor Joist Species Dimensions and Spacing (Table R502.3.1(1) & Table R502.3.1(2))	N/A	
Attic or additional Floor Joist Species Dimensions and Spacing (Table R802.4(1) and R802.4(2))	Roof Trusses	

Applicant: The Vesta Corp.

Date: 4/11/12

Address: 11 Ballpark Dr.

C-B-L: 371-A-46

permit # 2012-04-3739

CHECK-LIST AGAINST ZONING ORDINANCE

Date - new single family

Zone Location - R-2

Interior or corner lot - ~~both~~

Proposed Use/Work - build new single family ranch w/ attached two car garage

Sevage Disposal - public.

Lot Street Frontage - 50' min. - 204.06' given OK

Front Yard - 25' min. - 26' scaled to building. - front steps encroach but extend $\leq 6'$ Section 14-425

Rear Yard - 25' min. - 27.5 scaled - bulkhead encroaches but OK under 14-425. OK
Footprint ≤ 50 sf.

Side Yard - 1 story - 12' min. side yard on a side street - 20' min. - 51.25' scaled OK

Projections -

Width of Lot - 80' min. - 198' scaled OK

Height - 35' max. - scales @ 15.5' @ lowest grade. OK

Lot Area - 10,000 sq ft min. - 138,008 sq ft given OK

Lot Coverage Impervious Surface - 20% = 27616 sq ft

Area per Family - 10,000 sq ft OK

Off-street Parking - 2 spaces required - garage 24' x 20' 8" OK

Loading Bays - N/A

Site Plan - Level I Minor Residential Site Plan

Shoreland Zoning/Stream Protection - N/A

Flood Plains - Panel 2 - Zone X

$24 \times 28 = 672 \text{ sq ft}$
 $26 \times 38 = 988 \text{ sq ft}$
 $16 \times 24 = 384 \text{ sq ft}$
 bulkhead $5.33 \times 6 = 31.98 \text{ sq ft}$
 entry porch $5 \times 3 = 15 \text{ sq ft}$
 " $5 \times 4 = 20 \text{ sq ft}$
 rear entry $4 \times 2 = 8 \text{ sq ft}$
2119 sq ft OK



PORTLAND MAINE

Strengthening a Remarkable City, Building a Community for Life • www.portlandmaine.gov

Receipts Details:

Tender Information: Check , Check Number: 9911

Tender Amount: 100.00

Receipt Header:

Cashier Id: bsaucier

Receipt Date: 5/1/2012

Receipt Number: 43429

Receipt Details:

Referance ID:	6340	Fee Type:	BP-INSP
Receipt Number:	0	Payment Date:	
Transaction Amount:	100.00	Charge Amount:	100.00
Job ID: Job ID: 2012-04-3739-SF - SFH			
Additional Comments: 11 Ballpark			

Thank You for your Payment!



General Building Permit Application

FD # 2012-04-3739-SF

Entered 4/10/12 (15)

If you or the property owner owes real estate or personal property taxes or user charges on any property within the City, payment arrangements must be made before permits of any kind are accepted.

Location/Address of Construction: <u>11 Ballpark Dr., Portland</u>		
Total Square Footage of Proposed Structure <u>House 1516 + Garage 528</u> <u>total 2044</u>		Square Footage of Lot <u>13,808</u>
Tax Assessor's Chart, Block & Lot Chart# <u>371</u> Block# <u>A</u> Lot# <u>46</u>	Owner: <u>Ballpark Develop-</u> <u>ment LLC</u>	Telephone: <u>797-4308</u>
Lessee/Buyer's Name (If Applicable) <u>the Vesta Corp.</u>	Applicant name, address & telephone: <u>the Vesta Corp</u> <u>P.O. Box 1464</u> <u>Portland ME 04104</u> <u>207-879-2217</u>	Cost Of Work: \$ <u>150,000</u> Fee: \$ <u>75.00</u> C of O Fee: \$ <u>1896.50</u>
Current Specific use: <u>Raw land</u> If vacant, what was the previous use? <u>land</u> Proposed Specific use: <u>single family home</u>		
Project description: <u>To build 1500 SF ranch with 2 car attached</u> <u>garage</u>		
Contractor's name, address & telephone: <u>the Vesta Corp, P.O. Box 1464, Portland, ME 04104</u> Who should we contact when the permit is ready: <u>Mike DiMillo</u> Mailing address: <u>14 Oakland Rd</u> <u>Falm., ME 04105</u> Phone: <u>232-1010</u>		

207-879-2217

RECEIVED
APR 10 2012
City of Building Inspections
City of Portland Maine

Please submit all of the information outlined in the Commercial Application Checklist. Failure to do so will result in the automatic denial of your permit.

In order to be sure the City fully understands the full scope of the project, the Planning and Development Department may request additional information prior to the issuance of a permit. For further information visit us on-line at www.portlandmaine.gov, stop by the Building Inspections office, room 315 City Hall or call 874-8703.

I hereby certify that I am the Owner of record of the named property, or that the owner of record authorizes the proposed work and that I have been authorized by the owner to make this application as his/her authorized agent. I agree to conform to all applicable laws of this jurisdiction. In addition, if a permit for work described in this application is issued, I certify that the Code Official's authorized representative shall have the authority to enter all areas covered by this permit at any reasonable hour to enforce the provisions of the codes applicable to this permit.

Signature of applicant: <u>Michael DiMillo</u>	Date: <u>4/9/12</u>
--	---------------------

This is not a permit; you may not commence ANY work until the permit is issued.



**Level I: Minor Residential
Site Plan Application
PORTLAND, MAINE**

Planning and Urban Development Department
Planning Division and Planning Board

PROJECT NAME: 11 Ballpark Dr., Portland

PROPOSED DEVELOPMENT ADDRESS:
11 Ballpark Drive, Portland

PROJECT DESCRIPTION:
New construction of single family residence
with attached 2 car garage.

CHART/BLOCK/LOT: 371-A-46 PRELIMINARY PLAN _____

FINAL PLAN ✓

CONTACT INFORMATION:

APPLICANT
Name: The Vesta Corp.
Address: P.O. Box 1464
Portland ME
Zip Code: 04104
Work #: 879-2217
Cell #: 232-8050
Fax #: 879-2217
Home: 879-2217
E-mail: mdimillo@maine.rr.com

PROPERTY OWNER
Name: Ballpark Dr. Dev. LLC
Address: 67 Haverly Way
Portland, ME 04103
Zip Code: 04103
Work #: _____
Cell #: _____
Fax #: _____
Home: _____
E-mail: _____

BILLING ADDRESS
Name: The Vesta Corp
Address: _____
(above)
Zip: _____
Work #: _____
Cell #: 232-1010
Fax #: _____
Home: _____
E-mail: _____

RECEIVED

APR 10 2012

Dept. of Building Inspections
City of Portland Maine

~As applicable, please include additional contact information on the next page~

AGENT/REPRESENTATIVE

Name: Maria D. Dillo
Address: 14 Oakland Rd
Falmouth, ME
Zip Code: 04105
Work #: 879-2217
Cell #: 232-1010
Fax #: 879-2217
Home: 879-2217
E-mail: mdmillo@maine
rr.com

ENGINEER

Name: URS
Address: 477 Congress St., 9th Fl
Portland, ME
Zip Code: 04101
Work #: 879-7686
Cell #: _____
Fax #: 879-7685
Home: _____
E-mail: _____

SURVEYOR

Name: Owen Haskell
Address: 390 Rt. 1, Unit 10
Falmouth, ME
Zip Code: 04105
Work #: 774-0424
Cell #: _____
Fax #: 774-0511
Home: _____
E-mail: ebrewer@owenhaskell.com

DEVELOPMENT REVIEW FEES:

Check all reviews that apply. Payment may be made in cash or check to the City of Portland.

<input checked="" type="checkbox"/> Level I - Minor Residential Site Plan <input checked="" type="checkbox"/> Application Fee (flat fee)	\$300
Mailed notices to abutters are now required for single family, two-family and the addition of a unit being reviewed as a Level I minor residential site plan. The applicant will be billed for the notice costs.	.75 cents each <i>x 2 = \$1.50</i>
<input type="checkbox"/> Inspection Fee, due after approval (flat fee)	\$100.
<input type="checkbox"/> Performance Guarantee	Exempt except for those projects that complete construction in the winter and the site work is incomplete

Refer to the application checklist (page 5) for a detailed list of submittal requirements.

Portland's development review process and requirements are outlined in the Land Use Code (Chapter 14), which includes the Subdivision Ordinance (Section 14-491) and the Site Plan Ordinance (Section 14-521). Portland's Land Use Code is on the City's web site: www.portlandmaine.gov Copies of the ordinances may be purchased through the Planning Division.

I hereby certify that I am the Owner of record of the named property, or that the owner of record authorizes the proposed work and that I have been authorized by the owner to make this application as his/her authorized agent. I agree to conform to all applicable laws of this jurisdiction. In addition, if a permit for work described in this application is issued, I certify that the Planning Authority and Code Enforcement's authorized representative shall have the authority to enter all areas covered by this permit at any reasonable hour to enforce the provisions of the codes applicable to this permit.

This application is for a Site Plan review only. A Performance Guarantee, Inspection Fee, Building Permit Application (attached) and associated fees will be required prior to construction.

Signature of Applicant: <i>Michael DeWillo</i>	Date: <i>4/9/12</i>
---	------------------------

Please refer to Article V, Site Plan of the City of Portland Land Use Code for detailed information concerning the City's site plan review process, thresholds and standards. Should you have any questions regarding the submittal requirements or any other aspect of the site plan review process, please contact the Planning Division.

City of Portland Planning Division
 389 Congress Street
 Portland, Maine 04101
 (207) 874-8719
www.portlandmaine.gov

Office Hours:
 Unless noted, office hours are
 Monday thru Friday
 8:00 a.m. – 4:30 p.m.

11 Ballpark Dr, Portland

General Submittal Requirements – Level 1 Minor Residential

Applicant Checklist	Planner Checklist	Number of Copies	Submittal Requirement
<input checked="" type="checkbox"/>	<input type="checkbox"/>	4	Completed application form.
<input checked="" type="checkbox"/>	<input type="checkbox"/>	1	Application fees.
<input checked="" type="checkbox"/>	<input type="checkbox"/>	4	Written description of project.
<input checked="" type="checkbox"/>	<input type="checkbox"/>	4	Evidence of right, title and interest.
<input type="checkbox"/> N/A	<input type="checkbox"/>	4	Copies of required state and/or federal permits.
<input checked="" type="checkbox"/>	<input type="checkbox"/>	4	Written assessment of zoning.
<input checked="" type="checkbox"/>	<input type="checkbox"/>	4	Written Description of existing and proposed easements or other burdens.
<input type="checkbox"/> N/A	<input type="checkbox"/>	4	Written requests for waivers from individual site plan and/or technical standards.
<input checked="" type="checkbox"/>	<input type="checkbox"/>	4	Evidence of financial and technical capacity.
<input checked="" type="checkbox"/>	<input type="checkbox"/>	4	Evidence of utilities capacity to serve the development.
<input checked="" type="checkbox"/>	<input type="checkbox"/>	4	Written summary of fire safety (referencing NFPA fire code and Section 3 of the City of Portland Technical Manual).

Site Plans and Boundary Survey Requirements – Level 1 Minor Residential

Applicant Checklist	Planner Checklist	Number of Copies	Submittal Requirement
<input checked="" type="checkbox"/>	<input type="checkbox"/>	4	Boundary survey meeting the requirements of section 13 of the City of Portland Technical Manual.
<input checked="" type="checkbox"/>	<input type="checkbox"/>	4	Site Plan Including the following:
<input checked="" type="checkbox"/>	<input type="checkbox"/>		▪ Existing and proposed structures with distance from property line (including location of proposed piers, docks or wharves if in Shoreland Zone).
<input checked="" type="checkbox"/>	<input type="checkbox"/>		▪ Location and dimension of existing and proposed paved areas.
<input checked="" type="checkbox"/>	<input type="checkbox"/>		▪ Proposed ground floor area and finish floor elevation (FFE).
<input checked="" type="checkbox"/>	<input type="checkbox"/>		▪ Exterior building elevations (show all 4 sides).
<input type="checkbox"/>	<input type="checkbox"/>		▪ Identification of an proposed protection measures for any significant natural features located in the site (including wetlands, ponds, watercourses, floodplains, significant wildlife habitats and fisheries or other important natural features listed in Section 14-526 (b)1. of the Land Use Code).
<input checked="" type="checkbox"/>	<input type="checkbox"/>		▪ Existing and proposed utilities (or septic system, where applicable)
<input checked="" type="checkbox"/>	<input type="checkbox"/>		▪ Existing and proposed grading and contours.
<input checked="" type="checkbox"/>	<input type="checkbox"/>		▪ Proposed stormwater management and erosion controls.
<input checked="" type="checkbox"/>	<input type="checkbox"/>		▪ Total area and limits of proposed land disturbance.
<input type="checkbox"/> N/A	<input type="checkbox"/>		▪ Proposed protections to or alterations of watercourses.
<input type="checkbox"/> N/A	<input type="checkbox"/>		▪ Proposed wetland protections or impacts.
<input checked="" type="checkbox"/>	<input type="checkbox"/>		▪ Existing vegetation to be preserved and proposed site landscaping and street trees.
<input checked="" type="checkbox"/>	<input type="checkbox"/>		▪ Existing and proposed curb and sidewalk.
<input checked="" type="checkbox"/>	<input type="checkbox"/>		▪ Existing and proposed easements or public or private rights of way.
<input type="checkbox"/>	<input type="checkbox"/>		▪ A reduced boundary survey/site plan is required if original is larger than 11'x17'

The Vesta Corp. / Mike DiMillo 232-8050



New Residential Single Family Permit Application Checklist

All of the following information is required and must be submitted. Checking off each item as you prepare your application package will ensure your package is complete and will help to expedite the permitting process.

The Maine Home Construction Contracts Act requires that any home construction or repair work for more than \$3000. in materials or labor must be based on a written contract unless the parties agree to exempt themselves. A sample contract is available on the City's website at www.portlandmaine.gov, in the Inspection Office, Room 315 of Portland City Hall or call (207)874-8703 to have one mailed to you.

All new two-family residential developments will be required to go through the minor site plan review process.

One (1) complete set of construction drawings must include:

- Cross sections w/framing details
- Floor plans and elevations to scale
- Stair details including dimensions of: rise/run, head room, guards/handrails, baluster spacing
- Window and door schedules
- Foundation plans w/required drainage and damp proofing (if applicable)
- Detail egress requirements and fire separation (if applicable)
- Insulation R-factors of walls, ceilings & floors & U-factors of windows per the IEEC 2003
- Deck construction including: pier layout, framing, fastenings, guards, stair dimensions
- Reduced plans or electronic files in pdf format are required if originals are larger than 11" x 17"
- Proof of ownership is required if it is inconsistent with the assessors records

Separate permits are required for internal & external plumbing, HVAC, and electrical installations.

Four (4) copies of the boundary survey/site plan are required and must include:

- A stamped boundary survey to scale showing north arrow, zoning district & setbacks to a scale of $\geq 1" = 20'$. The boundary survey should include the following:
 - The footprint of the proposed structure and the distance from the actual property lines. Structures include decks, porches, steps, bow windows, cantilever sections and roof overhangs, sheds, pools, garages, and any other accessory structures and must be shown to scale. Photocopies of the plat or hand drawn footprints not to scale will not be accepted. The footprint should be consistent with the building plan.
- Location and dimensions of parking areas and driveways
- Finish floor or sill elevation (based on mean sea level datum)
- Location of proposed utilities
- Existing and proposed grades/contours
- Silt fence (erosion control) locations
- Location of two required street trees
- Separate requirements may apply for lots on unimproved streets
- A reduced boundary survey/site plan is required if original is larger than 11' x 17"

Please submit all of the information outlined in this application checklist. If the application is incomplete, the application may be refused.

In order to be sure the City fully understands the full scope of the project, the Planning and Development Department may request additional information prior to the issuance of a permit. For further information visit us on-line at www.portlandmaine.gov, stop by the Building Inspections office, room 315 City Hall or call 874-8703.

Permit Fee: \$30.00 for the first \$1000.00 construction cost, \$10.00 per additional \$1000.00 cost
Site plan review fee: \$300.00

This is not a Permit; you may not commence any work until the Permit is issued.



April 9, 2012

Ms. Barbara Barhydt, Development Review Services Manager
Dept. of Planning and Development
Portland City Hall
389 Congress Street
Portland, ME 04101

RE: Minor Residential Site Plan Application

Dear Ms. Barhydt,

Enclosed please find a complete Minor Residential Site Plan application and supporting information for 11 Ballpark Drive, Portland. Owen & Haskell, Inc. has been retained to prepare the site plans for the proposed house location on the site located on Portland Tax Map 371- A -46, property owned by Ballpark Drive Development, LLC and to be purchased by The Vesta Corporation of Portland, ME. The current deed is enclosed in this packet along with the purchase and sale agreement. Closing is to take place on or before May 15, 2012.

The lot is an approved building lot with a size of .317 acres and is part of the Ballpark Drive Subdivision.

Site Description:

This site is located within the Ballpark Drive Subdivision on a city approved street. The property is abutted by single family residential homes on 2 sides. There are also single family residence and vacant lot across the street as well as Washington Ave., Extension (it's a corner lot). The lot is mostly level and cleared.

Proposed Use:

This proposal includes construction of a 26' X 38' + 16' x 24' ranch style home with attached 6'x 22' breezeway and 22' x 24' (2) car garage. The home will include 3 Bedrooms and 2 full baths and will be approximately 1516 square feet of living space and a full unfinished basement. (See attached plans).

Zoning:

This location is zoned R-2 with single family residential homes a permitted use within this zone.

Page 2. Ms Barbara Barhydt, April 9, 2012

Title, right and interest:

Copy of the deed is attached. All easements, restrictions are contained therein.

Financial Capacity:

The Vesta Corporation will be securing a land loan from Peoples United Bank and using funds available through its principals home equity loan sufficient to buy the lot and complete construction.

Utilities:

The lot is serviced by underground utilities via CMP, Portland Public Services and Portland Water District. Location /access to utilities are depicted on the attached plans. Letters of serviceability have been sent to the agencies and their responses are attached or forthcoming.

Erosion Control:

Silt fencing and mulching as shown on plans. Additional as needed.

Wetlands:

None

Fire Safety:

Ballpark Drive can be accessed from Washington Avenue. There is hydrant located within 100 feet of the property. The home will have a sprinkler system per City code.

Abutters:

AZZOPARDI JOHANN &
INGRID H AZZOPARDI JTS
1925 WASHINGTON AVE
PORTLAND ME 04103

DUDLEY KEITH M & MICHELE B DUDLEY JTS
25 BALLPARK DR
PORTLAND ME 04103

Sincerely,

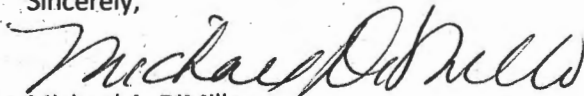

Michael A. DiMillo
President, The Vesta Corporation

PURCHASE AND SALE AGREEMENT - LAND ONLY

Offer Date April 2, 2012

4/3/12, Effective Date
Effective Date is defined in Paragraph 20 of this Agreement.

1. PARTIES: This Agreement is made between The Vesta Corporation, Michael A. DiMillo, president ("Buyer") and Ballpark Development LLC ("Seller").

2. DESCRIPTION: Subject to the terms and conditions hereinafter set forth, Seller agrees to sell and Buyer agrees to buy (all part of; If "part of" see para. 22 for explanation) the property situated in municipality of Portland, County of Cumberland, State of Maine, located at 11 Ballpark Drive, Lot 16 and described in deed(s) recorded at said County's Registry of Deeds Book(s) 22100, Page(s) 73.

3. PURCHASE PRICE: For such Deed and conveyance Buyer agrees to pay the total purchase price of \$ 65,000.00. Buyer has delivered; or will deliver to the Agency within 1 days of the Offer Date, a deposit of earnest money in the amount \$ 500.00. If said deposit is to be delivered after the submission of this offer and is not delivered by the above deadline, this offer shall be void and any attempted acceptance of this offer in reliance on the deposit being delivered will not result in a binding contract. Buyer agrees that an additional deposit of earnest money in the amount of \$ 0 will be delivered n/a. Failure by Buyer to deliver this additional deposit in compliance with the above terms shall constitute a default under this Agreement. The remainder of the purchase price shall be paid by wire, certified, cashier's or trust account check upon delivery of the Deed.

This Purchase and Sale Agreement is subject to the following conditions:

4. EARNEST MONEY/ACCEPTANCE: Keller Williams Realty ("Agency") shall hold said earnest money and act as escrow agent until closing; this offer shall be valid until April 4, 2012 (date) 12:01 AM PM; and, in the event of non-acceptance, this earnest money shall be returned promptly to Buyer. In the event that the Agency is made a party to any lawsuit by virtue of acting as escrow agent, Agency shall be entitled to recover reasonable attorney's fees and costs which shall be assessed as court costs in favor of the prevailing party.

5. TITLE AND CLOSING: A deed, conveying good and merchantable title in accordance with the Standards of Title adopted by the Maine Bar Association shall be delivered to Buyer and this transaction shall be closed and Buyer shall pay the balance due and execute all necessary papers on May 15, 2012 (closing date) or before, if agreed in writing by both parties. If Seller is unable to convey in accordance with the provisions of this paragraph, then Seller shall have a reasonable time period, not to exceed 30 calendar days, from the time Seller is notified of the defect, unless otherwise agreed to in writing by both Buyer and Seller, to remedy the title. Seller hereby agrees to make a good-faith effort to cure any title defect during such period. If, at the later of the closing date set forth above or the expiration of such reasonable time period, Seller is unable to remedy the title, Buyer may close and accept the deed with the title defect or this Agreement shall become null and void in which case the parties shall be relieved of any further obligations hereunder and any earnest money shall be returned to the Buyer.

6. DEED: The property shall be conveyed by a warranty deed, and shall be free and clear of all encumbrances except covenants, conditions, easements and restrictions of record which do not materially and adversely affect the continued current use of the property.

7. POSSESSION: Possession of premises shall be given to Buyer immediately at closing unless otherwise agreed in writing.

8. RISK OF LOSS: Until the closing, the risk of loss or damage to said premises by fire or otherwise, is assumed by Seller. Buyer shall have the right to view the property within 24 hours prior to closing for the purpose of determining that the premises are in substantially the same condition as on the date of this Agreement.

9. PRORATIONS: The following items, where applicable, shall be prorated as of the date of closing: rent, association fees, (other) none. Real estate taxes shall be prorated as of the date of closing (based on municipality's fiscal year). Seller is responsible for any unpaid taxes for prior years. If the amount of said taxes is not known at the time of closing, they shall be apportioned on the basis of the taxes assessed for the preceding year with a reapportionment as soon as the new tax rate and valuation can be ascertained, which latter provision shall survive closing. Buyer and Seller will each pay their transfer tax as required by State of Maine.

January 2012 Page 1 of 4 - P&S-LO Buyer(s) Initials [Signature] Seller(s) Initials [Signature]

Keller Williams Realty 50 Sewall Street, 2nd Floor Portland, ME 04102
Phone: (207)553-1371 Fax: Maria DiMillo

11 Ballpark Dr

10. DUE DILIGENCE: Buyer is encouraged to seek information from professionals regarding any specific issue or concern.

Neither Seller nor Licensee makes any warranties regarding the condition, permitted use or value of Sellers' real property. This Agreement is subject to the following contingencies, with results being satisfactory to Buyer:

CONTINGENCY	YES	NO	DAYS FOR COMPLETION	OBTAINED BY	TO BE PAID FOR BY
1. SURVEY Purpose: _____	<input type="checkbox"/>	<input checked="" type="checkbox"/>	_____	_____	_____
2. SOILS TEST Purpose: _____	<input type="checkbox"/>	<input checked="" type="checkbox"/>	_____	_____	_____
3. SEPTIC SYSTEM DESIGN Purpose: _____	<input type="checkbox"/>	<input checked="" type="checkbox"/>	_____	_____	_____
4. LOCAL PERMITS Purpose: _____	<input type="checkbox"/>	<input checked="" type="checkbox"/>	_____	_____	_____
5. HAZARDOUS WASTE REPORTS Purpose: _____	<input type="checkbox"/>	<input checked="" type="checkbox"/>	_____	_____	_____
6. UTILITIES Purpose: _____	<input type="checkbox"/>	<input checked="" type="checkbox"/>	_____	_____	_____
7. WATER Purpose: _____	<input type="checkbox"/>	<input checked="" type="checkbox"/>	_____	_____	_____
8. SUB-DIVISION APPROVAL Purpose: _____	<input type="checkbox"/>	<input checked="" type="checkbox"/>	_____	_____	_____
9. DEP/LURC APPROVALS Purpose: _____	<input type="checkbox"/>	<input checked="" type="checkbox"/>	_____	_____	_____
10. ZONING VARIANCE Purpose: _____	<input type="checkbox"/>	<input checked="" type="checkbox"/>	_____	_____	_____
11. HABITAT REVIEW/WATERFOWL Purpose: _____	<input type="checkbox"/>	<input checked="" type="checkbox"/>	_____	_____	_____
12. MDOT DRIVEWAY/ENTRANCE PERMIT Purpose: _____	<input type="checkbox"/>	<input checked="" type="checkbox"/>	_____	_____	_____
13. DEED RESTRICTION Purpose: _____	<input type="checkbox"/>	<input checked="" type="checkbox"/>	_____	_____	_____
14. TAX EXEMPT STATUS Purpose: _____	<input type="checkbox"/>	<input type="checkbox"/>	_____	_____	_____
15. OTHER Purpose: _____	<input type="checkbox"/>	<input checked="" type="checkbox"/>	_____	_____	_____

Further specifications regarding any of the above: none

Unless otherwise specified above, all of the above will be obtained and paid for by Buyer. If the result of any investigation or other condition specified herein is unsatisfactory to Buyer, Buyer will declare the Agreement null and void by notifying Seller in writing within the specified number of days, and any earnest money shall be returned to Buyer. If the result of any investigation or other condition specified herein is unsatisfactory to Buyer, and Buyer wishes to pursue remedies other than voiding the Agreement, Buyer must do so to full resolution within the time period set forth above; otherwise this contingency is waived. If Buyer does not notify Seller that an investigation is unsatisfactory within the time period set forth above, this contingency is waived by Buyer. In the absence of inspection(s) mentioned above, Buyer is relying completely upon Buyer's own opinion as to the condition of the property.

January 2012 Page 2 of 4 - P&S-LO Buyer(s) Initials *MP* Seller(s) Initials *MWA*

21. CONFIDENTIALITY: Buyer and Seller authorize the disclosure of the information herein to the real estate licensees, attorneys, lenders, appraisers, inspectors, investigators and others involved in the transaction necessary for the purpose of closing this transaction. Buyer and Seller authorize the lender and/or closing agent preparing the entire closing statement to release a copy of the closing statement to the parties and their licensees prior to, at and after the closing.

22. OTHER CONDITIONS: Maria DiMillo, a Maine licensee holding a Broker's license, has an interest in the Vesta Corporation.

23. GENERAL PROVISIONS:

- a. A copy of this Agreement is to be received by all parties and, by signature, receipt of a copy is hereby acknowledged. If not fully understood, contact an attorney. This is a Maine contract and shall be construed according to the laws of Maine.
- b. Seller acknowledges that State of Maine law requires buyers of property owned by non-resident sellers to withhold a prepayment of capital gains tax unless a waiver has been obtained by Seller from the State of Maine Revenue Services.
- c. Buyer and Seller acknowledge that under Maine law payment of property taxes is the legal responsibility of the person who owns the property on April 1, even if the property is sold before payment is due. If any part of the taxes is not paid when due, the lien will be filed in the name of the owner as of April 1 which could have a negative impact on their credit rating. Buyer and Seller shall agree at closing on their respective obligations regarding actual payment of taxes after closing. Buyer and Seller should make sure they understand their obligations agreed to at closing and what may happen if taxes are not paid as agreed.
- d. Buyer acknowledges that Maine law requires continuing interest in the property and any back up offers to be communicated by the listing agent to the Seller.

24. ADDENDA: Yes Explain: n/a No

Buyer's Mailing address is PO Box 1464, Portland, ME 04104

BUYER DATE
The Vesta Corporation

Michael A. DiMillo #12/12

BUYER DATE
Michael A. DiMillo, president

Seller accepts the offer and agrees to deliver the above-described property at the price and upon the terms and conditions set forth and agrees to pay agency a commission for services as specified in the listing agreement.

Seller's Mailing address is 67 Haverty Way, Portland, ME 04103

Michael A. DiMillo

SELLER DATE
Ballpark Development LLC

4/3/2012

SELLER DATE

COUNTER-OFFER

Seller agrees to sell on the terms and conditions as detailed herein with the following changes and/or conditions:

The parties acknowledge that until signed by Buyer, Seller's signature constitutes only an offer to sell on the above terms and the offer will expire unless accepted by Buyer's signature with communication of such signature to Seller by (date) _____ (time) _____ AM _____ PM.

SELLER DATE

SELLER DATE

The Buyer hereby accepts the counter offer set forth above.

BUYER DATE

BUYER DATE

EXTENSION:

The time for the performance of this Agreement is extended until _____

DATE

SELLER DATE

SELLER DATE

BUYER DATE

BUYER DATE



Maine Association of REALTORS®/Copyright © 2012
All Rights Reserved. Revised January 2012



QUITCLAIM DEED WITH COVENANT
(Maine Statutory Short Form)

MARY MARGARET I. HAVERTY of the City of Portland, County of Cumberland and State of Maine, being unmarried, whose mailing address is 67 Havertys Way, Portland, Maine 04103 (the "Grantor"), for consideration paid, grants to BALLPARK DRIVE DEVELOPMENT, LLC, a Maine limited liability company with a place of business in Portland, Maine and a mailing address of 67 Havertys Way, Portland, Maine 04103 (the "Grantee"), WITH QUITCLAIM COVENANT, a certain lot or parcel of land situated on the easterly side of Washington Avenue in the City of Portland, County of Cumberland and State of Maine, being more particularly described as follows:

Beginning at the most northerly corner of the parcel described herein which lies on the southwesterly line of Lester Drive Subdivision at its intersection with the northeasterly corner of land now or formerly of Edmund F. Murphy and Patricia Murphy and from whence the easterly sideline of Washington Avenue bears N 57° 55' 57" W a distance of 150.00 feet;

Thence, from said point of beginning, S 57° 55' 57" E along said Lester Drive Subdivision, 1059.68 feet;

Thence, N 31° 59' 07" E continuing along said Lester Drive Subdivision, 536.38 feet to land now or formerly of the Grace Baptist Church;

Thence, leaving said Lester Drive Subdivision line, S 59° 03' 17" E along said Grace Baptist Church land, 247.73 feet to land now or formerly Simon C. Ramsay and Rita H. Ramsay;

Thence, S 30° 56' 43" W along said Ramsay land, 113.77 feet;

Thence, S 56° 47' 07" E continuing along said Ramsay land, 75.59 feet to land now or formerly of Matthew J. Flaherty and Karen H. Flaherty;

Thence, S 47° 00' 30" W along said Flaherty land and land now or formerly of the Grantor, Mary Margaret I. Haverty, 391.69 feet;

Thence, S 17° 10' 07" E along said Haverty land and land now or formerly of Todd J. Friberg and Patricia C. Friberg, 451.67 feet to land now or formerly of Ira M. Wine and Mary-Agnes Wine;

Thence; S 62° 14' 40" W along said Wine land 100.00 feet to the southeast corner of remaining land of the Grantor, Mary Margaret I. Haverty;

Thence, N 25° 02' 09" W along said remaining Haverty land, 438.37 feet to an iron pipe or rod;

Thence, N 59° 36' 14" W continuing along said remaining Haverty land, 94.63 feet to an

[Handwritten signature]

iron pipe or rod;

Thence, S 30° 23' 46" W continuing along said remaining Haverty land, 167.48 feet to an iron pipe or rod;

Thence, N 59° 36' 14" W continuing along said remaining Haverty land, 88.00 feet to a monument;

Thence, N 59° 36' 14" W continuing along said remaining Haverty land, 87.50 feet to an iron pipe or rod;

Thence, S 61° 27' 13" W continuing along said remaining Haverty land, 152.35 feet to the most easterly corner of land now or formerly of Richard M. Luthe and Susan N. Luthe;

Thence along said Luthe land the following courses and distances:

N 52° 42' 38" W a distance of 285.61 feet;

N 52° 35' 27" W a distance of 109.24 feet;

N 76° 29' 06" W a distance of 223.57 feet to the corner common to land now or formerly of Christopher M. Huchanan and Tammy Huchanan and Herbert T. Ashby and Irene I. Ashby;

Thence, along said Huchanan land the following courses and distances:

N 15° 10' 54" W a distance of 20.18 feet;

N 15° 10' 54" W a distance of 60.82 feet;

N 04° 57' 54" W a distance of 14.88 feet;

S 79° 41' 10" W a distance of 150.70 feet to the easterly sideline of Washington Avenue;

Thence, N 04° 25' 25" W along said easterly sideline of Washington Avenue 130.27 feet to land now or formerly of Joanne Boswell;

Thence, along said Boswell land the following courses and distances:

N 79° 51' 57" E a distance of 150.75 feet;

N 04° 25' 25" W a distance of 54.80 feet to the southeasterly corner of land now or formerly of said Edmund F. Murphy and Patricia Murphy;

N 18° 18' 29" W along said Murphy land a distance of 78.43 feet;

Thence, N 24° 19' 35" E continuing along said Murphy land 175.00 feet to the point of

beginning.

Containing 14.09 acres, more or less.

The above boundary information is taken from a plan entitled "Standard Boundary Survey of: The Haverty Estate Property, Washington Ave. Extension, Portland, Maine" by Sebago Technics dated December 23, 1999 (revised through September 14, 2001) and recorded in said Registry of Deeds in Book 203, Page 558, and includes a parcel of land not shown on said plan conveyed to the Grantor, Mary Margaret I. Haverty, by Joanne Boswell by deed dated April 29, 2004 and recorded in said Registry of Deeds in Book 21190, Page 232, and excludes a portion of the land shown on said plan conveyed by the Grantor, Mary Margaret I. Haverty, to Edmund F. Murphy and Patricia Murphy by deed dated November 8, 2004 and recorded in said Registry of Deeds in Book 22025, Page 7.

Bearings are based on a plan of land entitled "Plan of Division of Land, The Haverty Estate Property, Ballpark Drive Subdivision" by URS Corporation, Portland, Maine, dated November 22, 2004, recorded in said Registry of Deeds in Plan Book 204, Page 855 (the "Plan")

Further reference is made to a related plan recorded with the Plan entitled "Residential Lot Subdivision Plat Ballpark Drive Subdivision" dated November 22, 2004, and recorded in said Registry of Deeds in Plan Book 204, Page 856 (the "Subdivision Plan").

The Plan and the Subdivision Plan are hereinafter collectively referred to as the "Project Plans".

The premises conveyed herein are subject to the following:

1. Rights and easements acquired by the City of Portland by virtue of a Taking dated June 3, 1963 and recorded in said Registry of Deeds in Book 2764, Page 362;
2. Real Estate Tax Agreement by and between Joanne Boswell and the Grantor, Mary Margaret I. Haverty, dated April 29, 2004, and recorded in said Registry of Deeds in Book 21190, Page 234; and
3. General Notes, Setbacks, Stream Buffer, Easements and other matters shown on the Project Plans,

The premises conveyed herein comprise Lots 1 through 16, Lot 18 and the area encompassing Ballpark Drive as shown on the Project Plans, specifically excluding and not conveying herein Lot 17 as shown on the Project Plans, which Lot 17 is being retained by the Grantor, Mary Margaret I. Haverty.

Excepting and reserving to the Grantor, Mary Margaret I. Haverty, her heirs and assigns, an easement in common with the Grantee, its successors and assigns, to use Ballpark Drive shown on the Project Plans for vehicular and pedestrian access to and from Lot 17 shown thereon and for the installation, maintenance, repair and replacement of utilities over, under and through

Ballpark Drive to serve Lot 17 including, but not limited to, power lines, sewer and water lines, telephone and other communication lines, and cable television lines. The Grantor, Mary Margaret I. Haverty, her heirs and assigns, shall repair Ballpark Drive as nearly as practical following any activity therein pursuant to the exercise of said easement, which obligation shall be enforceable by all parties having rights in and to the use of Ballpark Drive. Following the acceptance of Ballpark Drive as a public street, the use thereof by the Grantor, Mary Margaret I. Haverty, her heirs and assigns, shall be further subject to all applicable municipal ordinances and regulations with respect thereto.

Reference is made to (a) a Short Form Trustee's Deed from Mary Margaret I. Haverty, Trustee of the John E. Haverty Trust - 1990, to the Grantor, Mary Margaret I. Haverty, dated August 22, 2000 and recorded in said Registry of Deeds in Book 15682, Page 290, and (b) Warranty Deed from Joanne Boswell to the Grantor, Mary Margaret I. Haverty, dated April 29, 1004 and recorded in said Registry of Deeds in Book 21190, Page 232, for the Grantor's source of title to the premises conveyed herein.

IN WITNESS WHEREOF, I, the said MARY MARGARET I. HAVERTY, have hereunto set my hand and seal this 8th day of December, 2004.

WITNESS:



Mary Margaret I. Haverty

STATE OF MAINE
COUNTY OF CUMBERLAND, ss.

December 8, 2004

Then personally appeared the above named Mary Margaret I. Haverty and acknowledged the foregoing instrument to be her free act and deed.

Before me,

Notary Public/Attorney at Law

RICHARD A. SHINAY
Print name

Received
Recorded Register of Deeds
Dec 08, 2004 02:36:24P
Cumberland County
John B O'Brien

Sec. 14-76. Purpose.

The purpose of the R-2 residential zone is:

To provide for low-density residential development characterized by single-family homes on individual lots in outlying areas of the city and along traffic corridors with limited additional traffic capacity.

(Ord. No. 533-84, 5-7-84)

Sec. 14-77. Permitted uses.

The following uses are permitted in the R-2 residential zone:

(a) *Residential:*

- 1. Single-family detached dwellings.
2. Handicapped family unit, as defined in section 14-47 (definitions) of this article for handicapped persons plus staff.
3. Single-family, multiple-component manufactured housing, as defined in section 14-47 (definitions) of this article, except in a National Register Historic District.
4. Single-family, single-component manufactured housing, as defined in section 14-47 (definitions) of this article, on individual lots under separate and distinct ownership, except in a National Register Historic District and until May 1, 1985, on the islands, provided that each unit meets the performance standards listed below:
- a. More than half of the roof area of each unit shall be a double pitched Class C rated shingled roof with a minimum pitch of 3/12.
 - b. Each unit shall be installed on a full foundation or a concrete frost wall in accordance with all applicable codes and regulations. Any hitch or tow bar shall be removed from the unit after it is placed on its foundation or frost wall. In the case of a frost wall, vermin proof skirting shall be installed on all sides of the unit. The skirting

may consist of either (a) concrete or masonry block or (b) manufactured skirting. If concrete or masonry block skirting is installed, either the exterior siding of the unit shall extend within one (1) foot of grade or decorative masonry siding shall be applied. If manufactured skirting material is installed, the color shall be identical to or compatible with the exterior siding of the unit.

- c. Each unit shall have exterior siding that is residential in appearance, including but not limited to natural materials such as wood clapboards or shakes, or exterior materials which simulate wood. Clapboards or simulated clapboards shall have less than eight (8) inches of exposure and sheet metal type siding shall not be permitted.
- d. Each unit shall have the long side of the unit parallel to the street line where the required street frontage is met.
- e. Each unit shall be provided with at least two (2) trees meeting the city's arboricultural specifications and which are clearly visible from the street line and are located so as to visually widen the narrow dimension or proportion of the unit.
- f. Each unit shall have all fuel oil supply systems constructed and installed within the foundation wall or underground in accordance with all applicable codes and regulations.
- g. No unit shall be horizontally or vertically attached to any other unit or other structure, provided however, that this provision shall not be deemed to prohibit building additions, such as porches, garages, room additions or solar greenhouses.

(b) *Other:*

- 1. Reserved;
- 2. Parks and other active and passive noncommercial

recreation spaces;

3. Agriculture, including nurseries, greenhouses, and truck gardens, providing that there is no sale of products not produced on the premises; a single stand with no more than two hundred (200) square feet in floor area, for the sale of agricultural products produced on the premises shall be permitted;
4. Accessory uses customarily incidental and subordinate to the location, function, and operation of principal uses, subject to the provisions of section 14-404 (accessory uses) of this article;
5. Home occupations, subject to the provisions of section 14-410 (home occupation) of this article;
6. Municipal uses, excluding those specifically set forth in section 14-78 of this division.
7. Wind energy systems, as defined and allowed in Article X, Alternative Energy.

(Ord. No. 533-84, 5-7-84; Ord. No. 261-84, § 1, 12-17-84; Ord. No. 35-85, § 1, 7-15-85; Ord. No. 80-88, § 1, 7-19-88; Ord. No. 86A-89, § 2, 8-21-89; Ord. No. 33-91, § 3, 1-23-91; Ord. No. 33-11/12, 1-18-12)

***Editor's note**--Ord. No. 80-88, § 1, adopted July 19, 1988, amended this section by adding subsection 14-77(b)6. See also the editor's note to Art. III of this chapter for additional provisions relative to Ord. No. 80-88.

Sec. 14-78. Conditional use.

The following uses shall be permitted only upon the issuance of a conditional use permit, subject to the provisions of section 14-474 (conditional uses) of this article and any special provisions, standards or requirements specified below:

(a) *Residential:*

1. Sheltered care group home, as defined in section 14-47 of this article, for up to twelve (12) individuals, plus staff, and serving a primary population which is not handicapped persons, parolees, persons involved in correctional prerelease programs, or current illegal drug



ROS

IM

RIVERSIDE INDUSTRIAL PKWY

CHAMS FARM DR

WASHINGTON AVE

R5

R5

C30

C1

B1

C28

RP

RP

ROS

R2

R2

RO

22268/57

Sewer Easement Ballpark
10/15

EASEMENT DEED

BALLPARK DRIVE DEVELOPMENT, LLC, a Maine limited liability company with a place of business in Portland, Maine and a mailing address of 67 Havertys Way, Portland, Maine 04103 (hereinafter referred to as "Grantor"), for consideration paid, grants to the CITY OF PORTLAND, a body politic and corporate located in the County of Cumberland and State of Maine, with a mailing address of 389 Congress Street, Portland, Maine 04101 (hereinafter referred to as "Grantee"), an easement over and through the area labeled "B" within Lot 16 as shown on plan of land entitled "Plan of Division of Land, The Haverty Estate Property, Ballpark Drive Subdivision" by URS Corporation, Portland, Maine, dated November 22, 2004, recorded in the Cumberland County Registry of Deeds in Plan Book 204, Page 855 (hereinafter referred to as the "Plan") for the purpose of installing, maintaining, repairing and replacing an underground force main sewer line, together with all fixtures and appurtenances thereto, which will connect to the Grantee's existing sewer line extending through the Grantor's property as shown on the Plan, a portion of which is located within Ballpark Drive as shown on the Plan.

Further reference is made to a related plan recorded with the Plan entitled "Residential Lot Subdivision Plat Ballpark Drive Subdivision" dated November 22, 2004, and recorded in said Registry of Deeds in Plan Book 204, Page 856.

By acceptance of this Easement Deed, Grantee agrees for itself and its successors and assigns to properly and professionally undertake all work permitted hereunder within the easement area at its sole cost and expense and, following the completion of any work within the easement area and the disturbance of the easement area or any land adjacent thereto, to restore the easement area and land adjacent thereto to its condition prior to the undertaking of such work.

Reserving to the Grantor, its successors and assigns, the use and enjoyment of the easement area for all purposes as are not inconsistent with and shall not materially interfere with the use thereof by the Grantee, its successors and assigns, for the purposes hereinabove described, provided that no building or any kind of permanent structure, including, but not limited to, walls and fences, shall be erected within said easement areas by Grantor, its successors or assigns, provided that this limitation shall not be deemed to prohibit the construction of a paved or unpaved driveway within said easement area; that no hedges, bushes or trees shall be planted within said easement areas by Grantor, its successors and assigns; and that Grantor, its successors and assigns, shall not remove earth from said easement areas, without the written permission of Grantee, its successors and assigns.

For Grantor's source of title to the easement area described above, reference is made to a deed from Mary Margaret I. Haverty dated December 8, 2004 and recorded in the Cumberland County Registry of Deeds in Book 22100, Page 73.

IN WITNESS WHEREOF, BALLPARK DRIVE DEVELOPMENT, LLC has caused this instrument to be executed by Mary Margaret I. Haverty, its Chief Executive Officer and Manager, thereunto duly authorized, as of the 13th day of January, 2005.



WITNESS:

Richard A. Shway

BALLPARK DRIVE DEVELOPMENT,
LLC

By: Mary Margaret I. Haverty
Mary Margaret I. Haverty, its Chief
Executive Officer and Manager

STATE OF MAINE
COUNTY OF CUMBERLAND, ss.

January 13, 2005

Then personally appeared the above-named Mary Margaret I. Haverty, Chief Executive Officer and Manager of Ballpark Drive Development, LLC, and acknowledged the foregoing instrument to be her free act and deed in her said capacity and the free act and deed of said limited liability company.

Before me,

Richard A. Shway
~~Attorney at Law/Notary Public~~

RICHARD A. SHWAY
Print name



April 9, 2012

To Whom it May Concern:

Please be advised that The Vesta Corporation has made application for a land loan for the purchase of 11 Ballpark Drive, Portland.

The loan is subject to underwriting approval based on the information provided.

Sincerely,

A handwritten signature in black ink, appearing to read "Victor Pizzuto". The signature is written in a cursive style with a large, prominent initial "V".

Victor Pizzuto
Vice President / Market Manager



STATEMENT DATE 03/17/12

000423 06HLCK01

001



MARIA L DIMILLO
MICHAEL A DIMILLO
P.O. BOX 1464
PORTLAND, ME 04104-0000

CORRESPONDENCE:
LOAN OPERATIONS
32 CHESTNUT STREET
LEWISTON, ME 04240
1-800-498-4481
www.TDBank.com



THIS IS NOTIFICATION THAT THIS PAYMENT IS COMING DUE ACCORDING TO THE TERMS SPECIFIED BELOW:

HOME EQUITY STATEMENT

ACCOUNT NUMBER [REDACTED]

***** ACCOUNT SUMMARY *****		***** PAYMENT SUMMARY *****	
STATEMENT CLOSING DATE	03/17/12	PAYMENT DUE DATE	04/09/12
DAYS IN BILLING CYCLE	31	PROTECTOR FEE/INS PREM	.00
CREDIT LINE	[REDACTED]	LOC NET FINANCE CHARGE	[REDACTED]
CREDIT LINE USED	[REDACTED]	LOC NET PRINCIPAL	.00
AVAILABLE CREDIT	196700.00 ←	TOTAL CURRENT DUE	[REDACTED]
CURRENT INTEREST RATE	[REDACTED]	TOTAL AMOUNT PAST DUE	.00
MONTHLY PERIODIC RATE (DPR)	[REDACTED]	TOTAL MINIMUM DUE	[REDACTED]
AVERAGE DAILY BALANCE	[REDACTED]	LATE CHARGES	.00
		FEES AND OTHER CHARGES	.00
		TOTAL AMOUNT DUE	[REDACTED]

***** INTEREST RATE SUMMARY *****						
PRODUCT	DAYS	ANNUAL	DAILY	AVERAGE	FINANCE	INT ADJ
TYPE	RATE IN	PERCENTAGE	PERIODIC	DAILY	CHARGE	DUE TO
	EFFECT	RATE	RATE	BALANCE	THIS PERIOD	BACKDATING
DC	31	[REDACTED]	[REDACTED]	[REDACTED]	[REDACTED]	0.00

***** TRANSACTION SUMMARY *****						
DATE	DESCRIPTION	AMOUNT	LATE/OTHER CHARGES	PROTECTOR FEE OR INS PREM	FINANCE CHARGE	PRINCIPAL CURRENT BALANCE
2/16	LAST STMT BAL	[REDACTED]				[REDACTED]
2/27	PAYMENT	[REDACTED]				[REDACTED]
3/13	PRINCIPAL PYMT	[REDACTED]				[REDACTED]
3/17	ENDING STMT BAL	[REDACTED]				[REDACTED]

See reverse side for important information.

Please return lower portion with your payment.

PAYMENT COUPON

Payment received at the mailing address (shown below) before 5:00 p.m. EST on any business day will be credited to your account as of the date received. Payments received at any other location may be subject to a delay in crediting of up to 5 days after the date of receipt.

HOME EQUITY STATEMENT

ACCOUNT NUMBER [REDACTED]
PAYMENT DUE DATE 04/09/12

TD BANK MAINE
PO BOX 8400
LEWISTON, ME 04243-8400

0521002800000053025033180800000197683

MARIA L DIMILLO
MICHAEL A DIMILLO
P.O. BOX 1464
PORTLAND, ME 04104-0000

4/2/12
212389255

TOTAL CURRENT DUE	[REDACTED]
TOTAL AMOUNT PAST DUE	.00
TOTAL MINIMUM DUE	[REDACTED]
OTHER AND LATE CHARGES	.00
TOTAL AMOUNT DUE	[REDACTED]

Amount Enclosed	
-----------------	--

⑆52100280⑆ 00000530250331⑈



Central Maine Power

April 5, 2012

Vesta Corporation
C/O Ms. Maria DiMillo
PO Box 1464
Portland, Maine 04104

RE: Electric Service, 11 Ballpark Drive, Portland

Dear Ms. DiMillo,

This letter is to advise you Central Maine Power has sufficient single phase electrical capacity in the area to serve the subject project.

Once the project is accepted by the City of Portland, the owner will need to call our Customer Service Center at 1-800-565-3181 to sign up for a New Account and a Work Request Order so we may start a cost estimate.

Please provide to CMP what size service and voltage the Customer will be requiring in order to get the needed information for costs and easements possibilities.

If you have any questions please feel free to call me at 828-2882.

Sincerely,

Paul DuPerre
Energy Service Specialist

An equal opportunity employer

162 Canco Rd. | Portland, ME 04103

www.cmpco.com

An Energy East Company

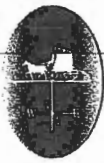

Portland Water District

FROM SEBAGO LAKE TO CASCO BAY

April 5, 2012

The Vesta Corporation
PO Box 1464
Portland, ME 04104

Attn: Maria DiMillo
Re: 11 Ballpark Drive, Portland
Ability to Serve with PWD Water

Dear: Ms. DiMillo

The Portland Water District has received your request for an Ability to Serve determination for the noted site submitted on April 2, 2012. Based on the information provided, we can confirm that the District will be able to serve the proposed project as further described in this letter.

Please note that this letter does not constitute approval of this project from the District. Please review this letter for any special conditions specified by the District and to determine the appropriate next steps to take to move your project through the submittal and approval process.

Existing Site Service

According to District records, the project site does currently have existing water service. A 1-inch diameter copper water service line, located as shown on the attached water service card, provides water service to this site. Please refer to the "Conditions of Service" section of this letter for requirements related to the use of this service.

Water System Characteristics

According to District records, there is an 8-inch diameter ductile iron water main on the south side of Ballpark Drive and a public fire hydrant located 65-feet from the site.

The current data from the nearest hydrant with flow test information is as follows:

Hydrant Location: Riverside Street at Washington Avenue
Hydrant Number: POD-HYD01341
Last Tested: 10/18/2001
Static Pressure: 70 psi
Residual Pressure: 69 psi
Flow: 838 GPM

Public Fire Protection

It is anticipated that this project will not include the installation of new public hydrants to be accepted into the District water system. The decision to require new hydrants and to determine their locations is solely that of the local fire department. It is your responsibility to contact your local fire department to ensure that this project is adequately served by existing and/or proposed hydrants.



Domestic Water Needs

The data noted above indicates there should be adequate pressure and volume of water to serve the domestic water needs of the proposed single family home.

Private Fire Protection Water Needs

You have indicated that this project will require water service to provide private fire protection to the site. Please note that the District does not guarantee any quantity of water or pressure through a fire protection service. Please share these results with your sprinkler system designer so that they can design the fire protection system to best fit the noted conditions. If the data is out of date or insufficient for their needs, please contact the MEANS Division to request a hydrant flow test and we will work with you to get more complete data.

Conditions of Service

The existing water service line that was installed as part of the original main extension in 2005 may be used to serve the proposed single family home. The existing service line may be used to serve both domestic and fire protection needs. The sprinkler system designer must approve the size of the water service line.

The split for the sprinkler service must be located after the water meter and must include a non-testable backflow prevention device. The meter must be appropriately sized by the sprinkler system designer to accommodate the necessary flows for fire protection. At the time of the service installation the District received a deposit for a 5/8-inch meter. Please contact us to request a meter upgrade and pay any necessary upgrade fees if a larger meter is required. Prior to activation of the water service, the sprinkler system designer must provide documentation that shows that a 1-inch line will be adequate to serve the fire protection needs and the designer must approve the size of the water meter to be installed.

If the existing water service line is not large enough to support the sprinkler system and a new service line will be required for fire protection, then a customer contribution fee will need to be collected. Since the water main in Ballpark Drive was installed by a private contractor in 2005 as part of a main extension, the District is required to collect a customer contribution fee. Chapter 65: Water Main Extension and Service Line Rule mandated by the Maine Public Utilities Commission requires that an applicant for new service contribute their proportionate share of an existing main extension during the period of 10 years following connection of the first customer. Typically the contribution amount is calculated as the customer's proportionate share of the length, divided by the number of customers that are served by the main extension. Should this be necessary we will calculate the contribution fee required upon request.

If the District can be of further assistance in this matter, please let us know.

Sincerely,
Portland Water District

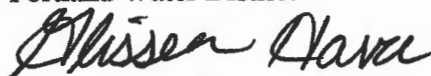

Glissen Havu, E.I.
Design Engineer



11 Ballpark Drive

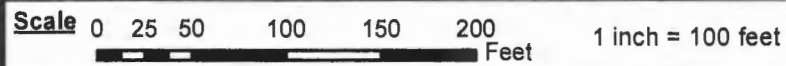

Disclaimer: This map is suitable for preliminary study and analysis and is based on PWD record information. PWD is not liable for any damages whatsoever resulting from inaccurate data or from errors made in the location and marking of its infrastructure.

Portland

Legend

- | | | | |
|----------------|--------------------|--------------------|-----------|
| ● Air Valve | ● Connection | ○ Combined Service | ● Manhole |
| ● Blow Off | ● Attribute Change | ○ Domestic Service | ● CSO |
| ● By Pass | ▲ Reducer | ○ Fire Service | → Gravity |
| ● Distribution | ● Hydrant | ● Private Hydrants | → Force |
| ● Transmission | ● Hydrant Control | ⊕ Meter Pits | |



PORTLAND WATER DISTRICT
225 Douglass Street
Portland, ME 04104

Drawn By: GJH

Prepared For: The Vesta Corporation

Scale: As Noted

Date: April 3, 2012

NOTES

1. Portland Water District will supply the water meter, meter horn and necessary fittings for installation. All other materials including valves to be supplied by the customer.
2. The meter is to be installed by Portland Water District personnel. Only Portland Water District personnel shall operate service valves.
3. The meter must be located directly after the service pipe enters the building.
4. The customer will provide a minimum of 18" of rigid copper pipe between the ball valves.
5. The meter shall not be permanently "boxed" without sufficient access for future service. There shall be a minimum of 36" of working space to enable servicing of the meter.
6. Customer is responsible for ensuring that the meter and service piping is sized appropriately to handle flows for both domestic and fire system usage.

BACKFLOW PREVENTER NOTES

1. The customer is to provide and install the backflow preventer prior to the meter installation. The customer will also provide test cock adapters (Brass 1/4" Flare x 1/4" MIP) which shall be accessible for testing.
2. The type of backflow preventer will be approved by the Portland Water District prior to installation and installed according to the Portland Water District Cross-Connection Guidelines.

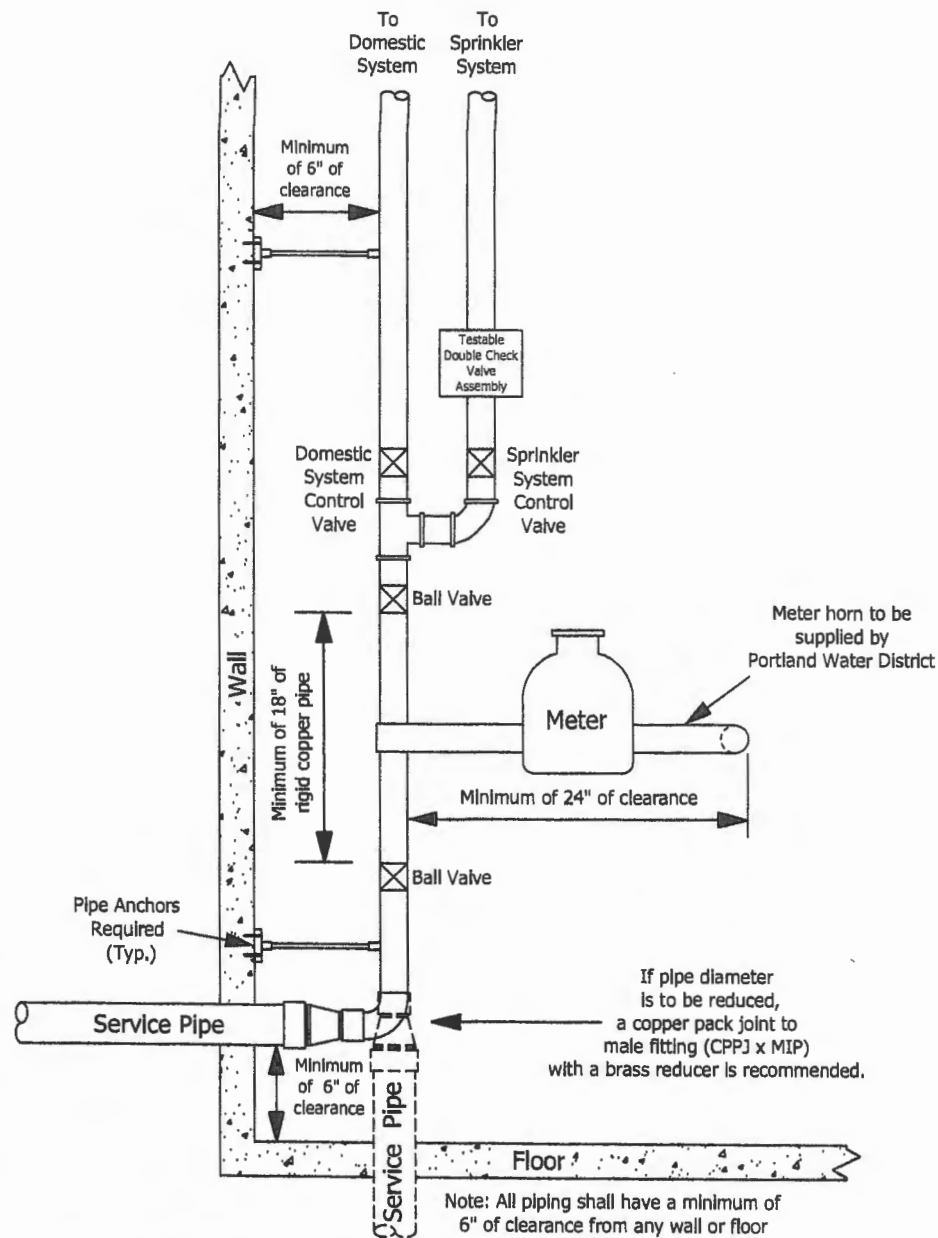

Portland Water District

ASSET MANAGEMENT & PLANNING DEPARTMENT
225 DOUGLASS STREET P.O. 3553 PORTLAND, MAINE 04104-3553

**Residential Fire Sprinkler
System-Vertical Installation**

SCALE: N.T.S.

DATE: 9/1/2009

NOTES

1. Portland Water District will supply the water meter, necessary fittings for installation and flanged meter spool piece (if required). All other materials including valves to be supplied by the customer.
2. The meter is to be installed by Portland Water District personnel. Only Portland Water District personnel shall operate service valves.
3. The meter must be located directly after the service pipe enters the building.
4. For piping with a diameter of 1" or less, the customer will provide a minimum of 24" of rigid copper pipe between the ball valves.
5. For piping with a diameter of 1-1/2" or larger, the customer will obtain a flanged meter spool piece from the Portland Water District. The customer is responsible for having the spool piece installed prior to the meter installation.
6. The meter shall not be permanently "boxed" without sufficient access for future service. There shall be a minimum of 36" of working space to enable servicing of the meter.
7. Customer is responsible for ensuring that the meter and service piping is sized appropriately to handle flows for both domestic and fire system usage.

BACKFLOW PREVENTER NOTES

1. The customer is to provide and install the backflow preventer prior to the meter installation. The customer will also provide test cock adapters (Brass 1/4" Flare x 1/4" MIP) which shall be accessible for testing.
2. The type of backflow preventer will be approved by the Portland Water District prior to installation and installed according to the Portland Water District Cross-Connection Guidelines.

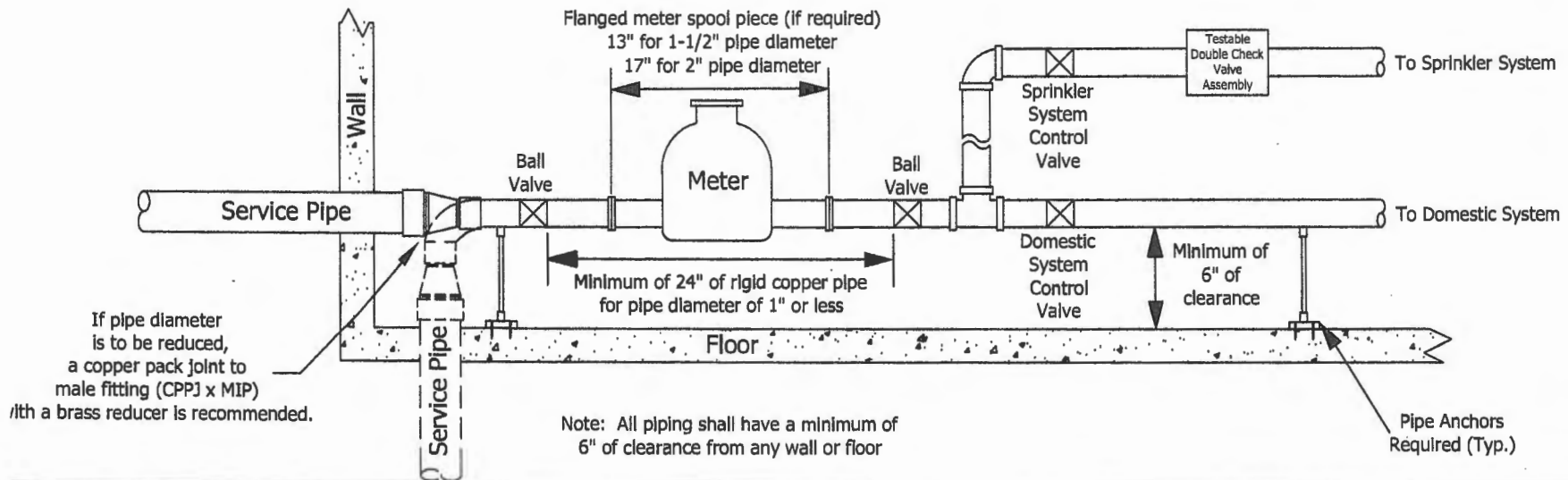

Portland Water District

ASSET MANAGEMENT & PLANNING DEPARTMENT
225 DOUGLASS STREET P.O. 3553 PORTLAND, MAINE 04104-3553

**Residential Fire Sprinkler
System-Horizontal Installation**

SCALE: N.T.S.

DATE: 9/1/2009

SERVICE RECORD

NO. 11 Ball Park Dr

ST. DIVISION 27

REG. NO. 200381

Code No. _____

Name _____

Name _____

Name _____

Name _____

Name _____

SERVICE DATA

MEASURES

Size of Pipe 1"

Kind of Pipe COPPER

Main to Stop 6'3"

Stop to St. Line DN

Date 6/23/2005

Mat. on Private _____

Depth/Main 5'6"

Depth/Private _____

Shut at Corp. _____

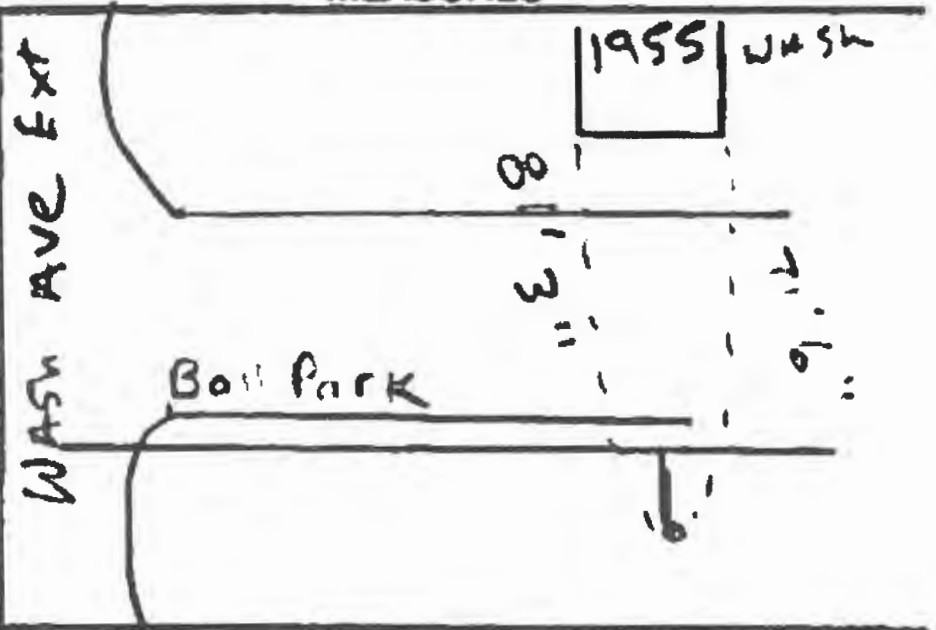

MEASURES TAKE FROM 1955 WASHINGTON AVE EXT

Maria DiMillo

From: Maria DiMillo [mdimillo@maine.rr.com]
Sent: Monday, April 02, 2012 9:40 AM
To: 'FJB@portlandmaine.gov'
Subject: 11 Ballpark Drive, Portland

THE VESTA CORPORATION
PO BOX 1464
PORTLAND, ME 04104
(207) 879-2217

April 2, 2012

VIA EMAIL - FJB@portlandmaine.gov

Mr. Frank Brancely - Senior Engineer
Engineering Division
Portland Public Services
55 Portland Street
Portland, ME 04101

RE: 11 Ballpark Drive, Portland

Dear Mr. Brancely

As required by the reviewing authorities of the City of Portland, we are writing to request a letter indicating the ability of Portland Public Services to provide sewer service to this project.

Description of Development Site:

This project is referenced on tax **Map 371, Block A, Lot 46** by the City of Portland. The site is currently undeveloped land within the approved subdivision of **BALLPARK DRIVE SUBDIVISION**.

Project Description:

Construct a **1504** SF single family ranch style home consisting of **3** bedrooms, **2** baths and **2**

CITY OF PORTLAND WASTEWATER CAPACITY APPLICATION

Department of Public Services,
55 Portland Street,
Portland, Maine 04101-2991



Mr. Frank J. Brancely,
Senior Engineering Technician,
Phone #: (207) 874-8832,
Fax #: (207) 874-8852,
E-mail: fjb@portlandmaine.gov

Date: 4/9/12

1. Please, Submit Utility, Site, and Locis Plans.

Site Address: 11 Ballpark Drive, Portland, ME
(Regarding addressing, please contact Leslie Kaynor, either at 756-8346, or at LMK@portlandmaine.gov)
 Chart Block Lot Number: 371-A-46
 Proposed Use: single family home
 Previous Use: land
 Existing Sanitary Flows: 0 GPD
 Existing Process Flows: 0 GPD
 Description and location of City sewer, at proposed building sewer lateral connection:
Sewer @ Lot 16 Ballpark Dr. stubbed onto lot w/ 4" PVC hookup.
Clearly, indicate the proposed connection, on the submitted plans.

Site Category
 Commercial _____
 Industrial (complete part 4 below) _____
 Governmental _____
 Residential
 Other (specify) _____

2. Please, Submit Domestic Wastewater Design Flow Calculations.

Estimated Domestic Wastewater Flow Generated: (3 BR) 270 GPD
 Peaking Factor/ Peak Times: 7:00 am & 6:30 pm
 Specify the source of design guidelines: (i.e. "Handbook of Subsurface Wastewater Disposal in Maine," "Plumbers and Pipe Fitters Calculation Manual," Portland Water District Records, _ Other (specify)

Note: Please submit calculations showing the derivation of your design flows, either on the following page, in the space provided, or attached, as a separate sheet.

3. Please, Submit Contact Information

Owner/Developer Name: Michael DiMillo / The Vesta Corp.
 Owner/Developer Address: P.O. Box 1464, Portland, ME 04104
 Phone: 232-8050 Fax: 879-2217 E-mail: mdimillo@maine.rr.com
 Engineering Consultant Name: (if needed) Paul Birkel / Wright Pierce
 Engineering Consultant Address: Washington Ave, Portland ME
 Phone: 773-2946 Fax: _____ E-mail: pfb@wright-pierce.com
 City Planner's Name: Phil DiPierro Phone: 874-8632

Note: Consultants and Developers should allow +/- 15 days, for capacity status, prior to Planning Board Review.

4. Please, Submit Industrial Process Wastewater Flow Calculations

Estimated Industrial Process Wastewater Flows Generated: _____ GPD

Do you currently hold Federal or State discharge permits? Yes _____ No _____

Is the process wastewater termed categorical under CFR 40? Yes _____ No _____

OSHA Standard Industrial Code (SIC): _____

Peaking Factor/Peak Process Times: _____

N/A

(<http://www.osha.gov/oshstats/sicser.html>)

Note: On the submitted plans, please show the locations, where the building's sanitary, and process water sewer laterals, exit the facility, where they enter the city's sewer, the location of any control manholes, wet wells, or other access points, and the locations of any filters, strainers, or grease traps.

Notes, Comments, or Calculations:

Site: 11 Ballpark Dr., Portland
Lot 16 Ballpark Dr. Subdiv.

to be built: - 3 BR, 2 Baths

Lot stubbed for service
during road construction
phase 2005 -

Per "as built" on file

- a. Orientation and Wayfinding – The site shall be designed so that the layout, features and/or signage clearly guide the movement of vehicles and pedestrians along safe and predictable paths both during the daytime and nighttime. Specifically, the site plan shall satisfy the following criteria:
- Placement of signage, lighting fixtures, landmarks, and landscape design features shall clearly guide users to and from the facility.
 - Site features shall be designed to avoid the creation of entrapment zones that afford users no opportunity to escape or retreat from an approaching hazard.
- b. Mechanical Access Control – If necessary, mechanical access control systems may be implemented such as assigning personnel at key building entry points or establishing other procedures such as mechanical auto closing devices, key cards, gates and other locking devices.

3.1.3. **Territorial Reinforcement:** Proposed developments shall be designed to clearly delineate private, semi-private, and public space.

X 3.2. FIRE HYDRANT STANDARDS

*(corner Washington Ave
ext & Riverside St.)*

3.2.1. All development constructed within the limits of Fire Districts 1 and 2 (as shown in Figure III-1) shall have a hydrant within five hundred (500') feet of all structures. Fire District Number 1 denotes the portion of the city with the highest density requiring increased Fire Department response. Fire District Number 2 denotes concentrations of industrial uses which may have hazardous chemicals on site.

3.2.2. All hydrants, private and public, shall comply with city code Chapter 10 and the Portland Water Districts standards.

3.2.3. Private hydrants shall be maintained by the property owner. A maintenance agreement, or other documentation if deemed acceptable by the Reviewing Authority, shall be required for all private hydrants. A follow-up will be conducted and a financial penalty will be levied for non-compliance. All compliances shall meet city code Chapter 10, which adopts by reference National Fire Protection Association (NFPA) #1 and #101.

X 3.3. SINGLE AND TWO FAMILY RESIDENTIAL DEVELOPMENT

3.3.3. As of September 16, 2010 all new construction of one and two family homes are required to be sprinkled in compliance with NFPA 13D. This is required by City Code. (NFPA 101 2009 ed.)

To be installed to City Code by:

*Dean & Allyn, Inc
Fire Protection - Special Hazards
Gray ME*



PORTLAND MAINE

Strengthening a Remarkable City, Building a Community for Life • www.portlandmaine.gov

Receipts Details:

Tender Information: Check , Check Number: 9904
Tender Amount: 1896.50

Receipt Header:

Cashier Id: bsaucier
Receipt Date: 4/10/2012
Receipt Number: 42734

Receipt Details:

Referance ID:	6029	Fee Type:	BP-C of O
Receipt Number:	0	Payment Date:	
Transaction Amount:	75.00	Charge Amount:	75.00
Job ID: Job ID: 2012-04-3739-SF - Construct 1500' ranch w/garage			
Additional Comments: 11 Ballpark Dr.			

Referance ID:	6031	Fee Type:	BP-MSFSR
Receipt Number:	0	Payment Date:	
Transaction Amount:	300.00	Charge Amount:	300.00
Job ID: Job ID: 2012-04-3739-SF - Construct 1500' ranch w/garage			

Additional Comments:

Referance ID:	6033	Fee Type:	BP-Constr
Receipt Number:	0	Payment Date:	
Transaction Amount:	1520.00	Charge Amount:	1520.00

Job ID: Job ID: 2012-04-3739-SF - Construct 1500' ranch w/garage

Additional Comments:

Referance ID:	6034	Fee Type:	UI-MI
Receipt Number:	0	Payment Date:	
Transaction Amount:	1.50	Charge Amount:	1.50

Job ID: Job ID: 2012-04-3739-SF - Construct 1500' ranch w/garage

Additional Comments:

Thank You for your Payment!

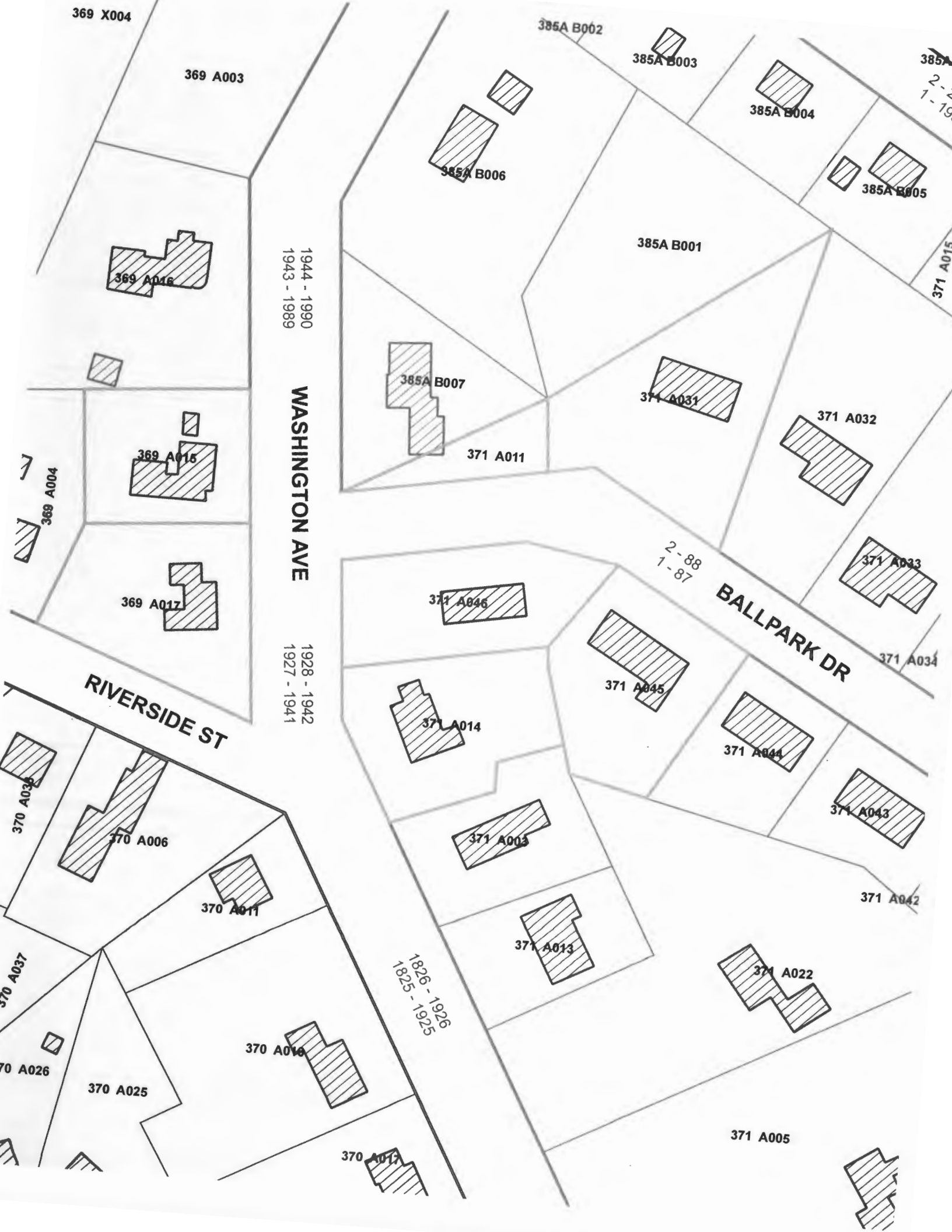

369 X004

369 A003

385A B002

385A B003

385A B004

385A B004

2-19
1-19

385A B006

385A B005

385A B001

1944 - 1990
1943 - 1989

369 A016

371 A015

385A B007

371 A031

371 A032

WASHINGTON AVE

369 A015

371 A011

7
369 A004

369 A017

2-88
1-87

371 A033

BALLPARK DR

371 A034

1928 - 1942
1927 - 1941

371 A046

371 A045

RIVERSIDE ST

371 A014

371 A044

370 A035

370 A006

371 A004

371 A043

370 A011

371 A042

1826 - 1926
1825 - 1925

371 A005

371 A013

371 A022

370 A037

370 A010

371 A005

370 A026

370 A025

370 A017

371 A005

AZZOPARDI JOHANN &
INGRID H AZZOPARDI JTS
1925 WASHINGTON AVE
PORTLAND , ME 04103

BALLPARK DRIVE DEVELOPMENT LLC
67 HAVERTYS WAY
PORTLAND , ME 04103

BOSWELL JOANNE WID WWII VET
1955 WASHINGTON AVE
PORTLAND, ME 04103

CLISHAM JAMES R
1938 WASHINGTON AVE
PORTLAND, ME 04103

DIDONATO DENNIS A &
MICHAELENE S JTS
1946 WASHINGTON AVE
PORTLAND, ME 04103

DUDLEY KEITH M &
MICHELE B DUDLEY JTS
16 TAYLOR LN
GRAY , ME 04039

JIMINO MICHAEL R &
MARY ANN JIMINO TRUSTEE
1407 RIVERSIDE ST
PORTLAND , ME 04103

Labels Requested For CBL:

369 A015

369 A017

371 A011

371 A014

371 A031

371 A045

371 A046

Gayle Guertin - 11 Ballpark Dr. notices

From: Gayle Guertin
To: Ann Machado; Marge Schmuckal
Date: 4/13/2012 12:20 PM
Subject: 11 Ballpark Dr. notices
CC: Gayle Guertin

Hi,

Mailed out abutters notices for 11 Ballpark Drive as of 4-13-12. /gg

IMPORTANT NOTICE FROM CITY OF PORTLAND

To residents and property owners: A Level I Minor Residential Development application was submitted to the Portland Inspections Division by Ballpark Drive Development, LLC to build a new single family home at 11 Ballpark Drive.

In accordance with the Portland Land Use Ordinance, notices of receipt of a Level I Minor Residential Development application must be sent to neighbors. This application will be reviewed administratively by City Staff.

Plans are available in the Portland Inspections Division, Room 315, City Hall. If you have any questions or wish to submit comments, contact Ann Machado, Zoning Specialist at 874-8709 or email amachado@portlandmaine.gov

IMPORTANT NOTICE FROM CITY OF PORTLAND

To residents and property owners: A Level I Minor Residential Development application was submitted to the Portland Inspections Division by Ballpark Drive Development, LLC to build a new single family home at 11 Ballpark Drive.

In accordance with the Portland Land Use Ordinance, notices of receipt of a Level I Minor Residential Development application must be sent to neighbors. This application will be reviewed administratively by City Staff.

Plans are available in the Portland Inspections Division, Room 315, City Hall. If you have any questions or wish to submit comments, contact Ann Machado, Zoning Specialist at 874-8709 or email amachado@portlandmaine.gov

IMPORTANT NOTICE FROM CITY OF PORTLAND

To residents and property owners: A Level I Minor Residential Development application was submitted to the Portland Inspections Division by Ballpark Drive Development, LLC to build a new single family home at 11 Ballpark Drive.

In accordance with the Portland Land Use Ordinance, notices of receipt of a Level I Minor Residential Development application must be sent to neighbors. This application will be reviewed administratively by City Staff.

Plans are available in the Portland Inspections Division, Room 315, City Hall. If you have any questions or wish to submit comments, contact Ann Machado, Zoning Specialist at 874-8709 or email amachado@portlandmaine.gov

IMPORTANT NOTICE FROM CITY OF PORTLAND

To residents and property owners: A Level I Minor Residential Development application was submitted to the Portland Inspections Division by Ballpark Drive Development, LLC to build a new single family home at 11 Ballpark Drive.

In accordance with the Portland Land Use Ordinance, notices of receipt of a Level I Minor Residential Development application must be sent to neighbors. This application will be reviewed administratively by City Staff.

Plans are available in the Portland Inspections Division, Room 315, City Hall. If you have any questions or wish to submit comments, contact Ann Machado, Zoning Specialist at 874-8709 or email amachado@portlandmaine.gov

Ability to serve:

In support of the applications to the reviewing authorities, we are writing to request a letter indicating the ability of Portland Public Services to service this project.

Please contact me if you have any questions relative to this matter.

Sincerely,

Maria DiMillo
The Vesta Corporation
E-mail: mdimillo@maine.rr.com
Cell: 207-232-1010

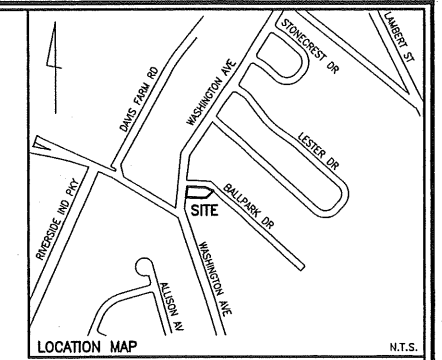

WASHINGTON AVENUE
PAVED - PUBLIC

TO RIVERSIDE ST.

BALLPARK DRIVE
(PAVED PUBLIC 50' WIDE)

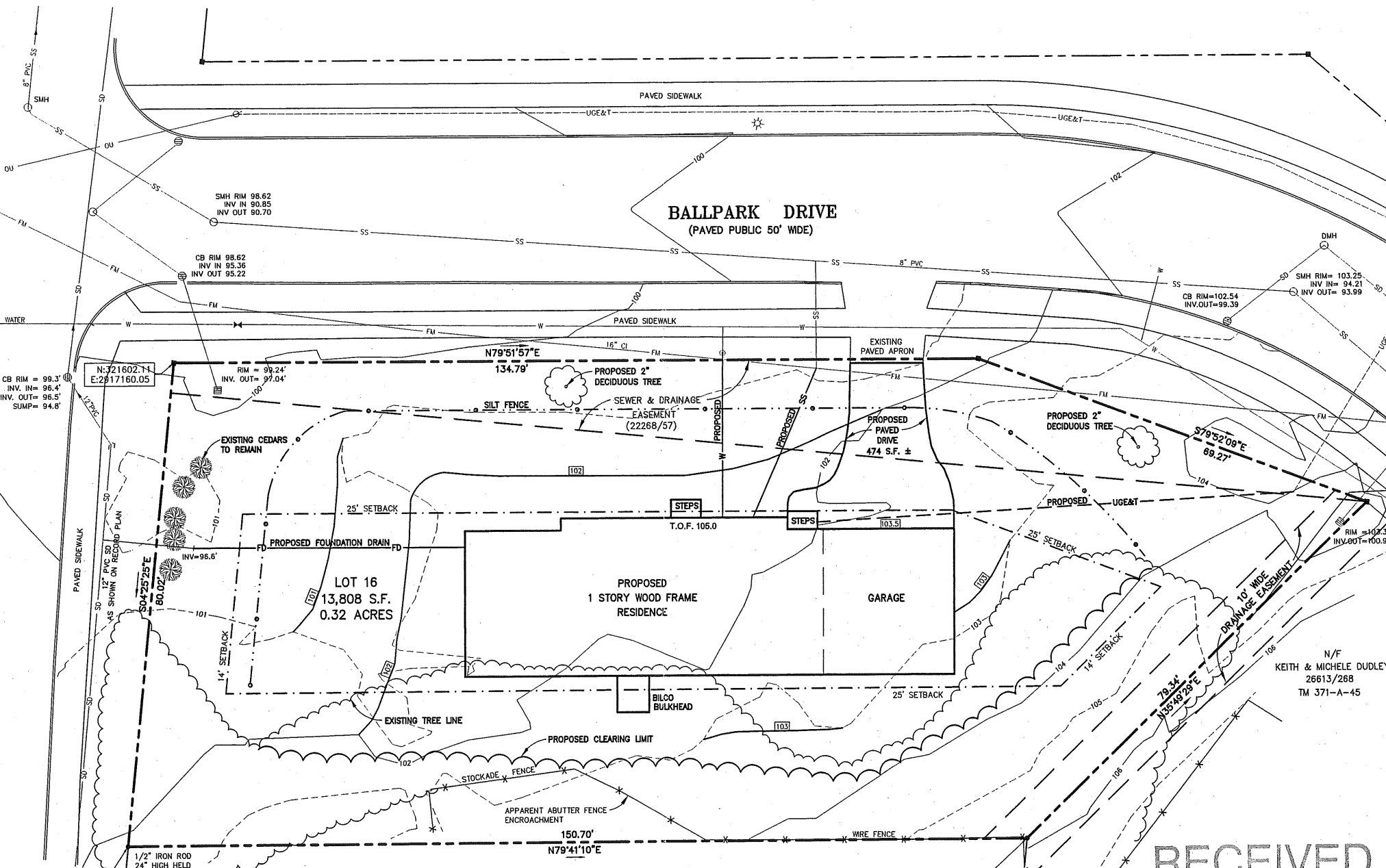

- LEGEND**
- MONUMENT
 - IRON PIPE OR ROD
 - ⊕ WATER VALVE
 - ⊙ UTILITY POLE
 - ⊙ LIGHT POLE
 - MANHOLE
 - ⊙ CATCH BASIN
 - DECIDUOUS TREE
 - CURB
 - CURB
 - OVERHEAD UTILITIES
 - UGE&T UNDERGROUND ELECTRIC & TEL.
 - WATER LINE
 - FM FORCE MAIN
 - SS SANITARY SEWER
 - SD STORM DRAIN
 - 100 EXISTING 1" CONTOUR
 - 103 PROPOSED 1" CONTOUR

UTILITY NOTE:
THE UNDERGROUND UTILITIES SHOWN HAVE BEEN LOCATED FROM FIELD SURVEY INFORMATION AND EXISTING DRAWINGS. THE SURVEYOR MAKES NO GUARANTEES THAT THE UNDERGROUND UTILITIES SHOWN COMPRISE ALL SUCH UTILITIES IN THE AREA, EITHER IN SERVICE OR ABANDONED. THE SURVEY FURTHER DOES NOT WARRANT THAT THE UNDERGROUND UTILITIES SHOWN ARE IN THE EXACT LOCATION INDICATED ALTHOUGH HE DOES CERTIFY THAT THEY ARE LOCATED AS ACCURATELY AS POSSIBLE FROM THE INFORMATION AVAILABLE. THE SURVEYOR HAS NOT PHYSICALLY LOCATED THE UNDERGROUND UTILITIES. CALL 1-800-DIGSAFE AT LEAST THREE BUSINESS DAYS BEFORE PERFORMING ANY CONSTRUCTION. DUE TO OSHA CONFINED SPACE REQUIREMENTS, ALL INVERTS AND PIPE SIZES MUST BE VERIFIED PRIOR TO ANY CONSTRUCTION.

PLAN REFERENCE:
1. "PLAN OF DIVISION OF LAND, THE HAVERTY ESTATE PROPERTY", BALLPARK DRIVE SUBDIVISION" MADE FOR MARGARET HAVERTY BY URS CORPORATION DATED 2-23-04 REVISED 11-17-04 RECORDED IN CUMBERLAND COUNTY REGISTRY OF DEEDS IN PLAN BOOK 204 PAGE 855.

- NOTES:**
- OWNER OF RECORD: BALLPARK DRIVE DEVELOPMENT LLC, 67 HAVERTY WAY, PORTLAND, MAINE 04103, C.C.R.D. BOOK 22100 PAGE 73.
 - PROPERTY IS SHOWN AS LOT 46 BLOCK A ON MAP 371 OF THE CITY OF PORTLAND ASSESSORS MAPS.
 - COORDINATES LISTED ON PLAN ARE BASED ON MAINE STATE PLANE COORDINATE SYSTE, WEST ZONE NAD83.
 - ELEVATIONS ARE BASED ON CITY OF PORTLAND DATUM.
 - BENCH MARK IS A BOLT IN A 3 FOOT OFFSET MONUMENT UNDER A MANHOLE AT THE SOUTHEAST CORNER OF JACKSON AND AUBURN STREET. ELEVATION IS 140.443 FEET.
 - ACCORDING TO THE FEDERAL EMERGENCY MANAGEMENT AGENCY (FEMA) FLOOD INSURANCE RATE MAP (FIRM), COMMUNITY PANEL NUMBER 230051 0002 C, REVISED DECEMBER 8, 1998, THE SUBJECT PROPERTY LIES IN ZONE X, AN AREA DETERMINED TO BE OUTSIDE THE 500-YEAR FLOOR PLAN.
 - ALL UTILITIES ARE FROM DESIGN PLANS PROVIDED BY URS.

RECEIVED

APR 10 2012

Dept. of Building Inspections
City of Portland Maine

ZONING:
THE SUBJECT PROPERTY IS A PORTION OF LAND SHOWN ON PLAN REFERENCE 1, LIES IN THE CITY OF PORTLAND'S R-2 RESIDENTIAL ZONE, AND IS SUBJECT TO THE FOLLOWING:
MINIMUM LOT FRONTAGE: 50 FEET
MINIMUM LOT SIZE: 10,000 S.F.
SETBACKS:
FRONT: 25 FEET
REAR: 25 FEET
SIDE: 12 FEET, 1 OR 1-1/2 STORY RESIDENCE
14 FEET, 2 STORY RESIDENCE
16 FEET, 2-1/2 STORY RESIDENCE

LOT SIZE = 13,808 S.F.
LOT COVERAGE = 2,580 S.F.
% OF SITE COVERED = 18.7%
TOTAL DISTURBED AREA = 7,955 S.F.
% OF SITE DISTURBED = 57.6%
GROUND FLOOR AREA OF BUILDING = 2,044 S.F.

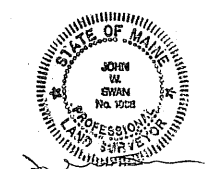

JOHN W. SWAN, PLS NO. 1038
DATE 4/9/12

SITE PLAN
OF
LOT 16 - 11 BALLPARK DRIVE, PORTLAND, MAINE
MADE FOR
THE VESTA CORPORATION
P.O. BOX 1464, PORTLAND, MAINE 04104

OWEN HASKELL, INC.
390 U.S. ROUTE ONE, FALMOUTH, ME 04105 (207) 774-0424
PROFESSIONAL LAND SURVEYORS

Drwn By OHI	Date APRIL 9, 2012	Job No. 2012-048P
Trace By JLW	Scale 1" = 10'	Drwg. No. 1
Check By JWS		
Book No. 1010		

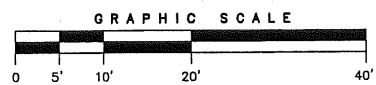

Ability to serve:

In support of the applications to the reviewing authorities, we are writing to request a letter indicating the ability of Portland Public Services to service this project.

Please contact me if you have any questions relative to this matter.

Sincerely,

Maria DiMillo
The Vesta Corporation
E-mail: mdimillo@maine.rr.com
Cell: 207-232-1010

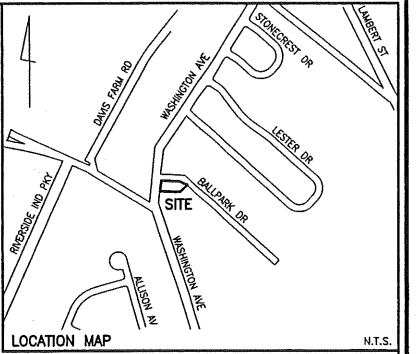

WASHINGTON AVENUE
PAVED - PUBLIC

TO RIVERSIDE ST.

BALLPARK DRIVE
(PAVED PUBLIC 50' WIDE)

LOT 16
13,808 S.F.
0.32 ACRES

PROPOSED
1 STORY WOOD FRAME
RESIDENCE

GARAGE

RECEIVED

APR 10 2012

Dept. of Building Inspections
City of Portland Maine

ZONING:
THE SUBJECT PROPERTY IS A PORTION OF LAND SHOWN ON PLAN REFERENCE 1, LIES IN THE CITY OF PORTLAND'S R-2 RESIDENTIAL ZONE, AND IS SUBJECT TO THE FOLLOWING:

MINIMUM LOT FRONTAGE: 50 FEET
MINIMUM LOT SIZE: 10,000 S.F.
SETBACKS:
FRONT: 25 FEET
REAR: 25 FEET
SIDE: 12 FEET, 1 OR 1-1/2 STORY RESIDENCE
14 FEET, 2 STORY RESIDENCE
16 FEET, 2-1/2 STORY RESIDENCE

LOT SIZE = 13,808 S.F.
LOT COVERAGE = 2,580 S.F.
% OF SITE COVERED = 18.7%
TOTAL DISTURBED AREA = 7,955 S.F.
% OF SITE DISTURBED = 57.6%
GROUND FLOOR AREA OF BUILDING = 2,044 S.F.

- LEGEND**
- MONUMENT
 - IRON PIPE OR ROD
 - ⊕ WATER VALVE
 - ⊙ UTILITY POLE
 - ⊙ LIGHT POLE
 - MANHOLE
 - ⊙ CATCH BASIN
 - DECIDUOUS TREE
 - CURB
 - CURB
 - OVERHEAD UTILITIES
 - UGE&T UNDERGROUND ELECTRIC & TEL.
 - WATER LINE
 - FM FORCE MAIN
 - SS SANITARY SEWER
 - SD STORM DRAIN
 - 100 EXISTING 1" CONTOUR
 - 103 PROPOSED 1" CONTOUR

UTILITY NOTE:
THE UNDERGROUND UTILITIES SHOWN HAVE BEEN LOCATED FROM FIELD SURVEY INFORMATION AND EXISTING DRAWINGS. THE SURVEYOR MAKES NO GUARANTEES THAT THE UNDERGROUND UTILITIES SHOWN COMPRISE ALL SUCH UTILITIES IN THE AREA, EITHER IN SERVICE OR ABANDONED. THE SURVEY FURTHER DOES NOT WARRANT THAT THE UNDERGROUND UTILITIES SHOWN ARE IN THE EXACT LOCATION INDICATED ALTHOUGH HE DOES CERTIFY THAT THEY ARE LOCATED AS ACCURATELY AS POSSIBLE FROM THE INFORMATION AVAILABLE. THE SURVEYOR HAS NOT PHYSICALLY LOCATED THE UNDERGROUND UTILITIES. CALL 1-800-DIGSAFE AT LEAST THREE BUSINESS DAYS BEFORE PERFORMING ANY CONSTRUCTION. DUE TO OSHA CONFINED SPACE REQUIREMENTS, ALL INVERTS AND PIPE SIZES MUST BE VERIFIED PRIOR TO ANY CONSTRUCTION.

PLAN REFERENCE:
1. "PLAN OF DIVISION OF LAND, THE HAVERTY ESTATE PROPERTY", BALLPARK DRIVE SUBDIVISION" MADE FOR MARGARET HAVERTY BY URS CORPORATION DATED 2-23-04 REVISED 11-17-04 RECORDED IN CUMBERLAND COUNTY REGISTRY OF DEEDS IN PLAN BOOK 204 PAGE 855.

- NOTES:**
- OWNER OF RECORD: BALLPARK DRIVE DEVELOPMENT LLC, 67 HAVERTY WAY, PORTLAND, MAINE 04103, C.C.R.D. BOOK 22100 PAGE 73.
 - PROPERTY IS SHOWN AS LOT 46 BLOCK A ON MAP 371 OF THE CITY OF PORTLAND ASSESSORS MAPS.
 - COORDINATES LISTED ON PLAN ARE BASED ON MAINE STATE PLANE COORDINATE SYSTE, WEST ZONE NAD83.
 - ELEVATIONS ARE BASED ON CITY OF PORTLAND DATUM.
 - BENCH MARK IS A BOLT IN A 3 FOOT OFFSET MONUMENT UNDER A MANHOLE AT THE SOUTHEAST CORNER OF JACKSON AND AUBURN STREET. ELEVATION IS 140.443 FEET.
 - ACCORDING TO THE FEDERAL EMERGENCY MANAGEMENT AGENCY (FEMA) FLOOD INSURANCE RATE MAP (FIRM), COMMUNITY PANEL NUMBER 230051 0002 C, REVISED DECEMBER 8, 1998, THE SUBJECT PROPERTY LIES IN ZONE X, AN AREA DETERMINED TO BE OUTSIDE THE 500-YEAR FLOOR PLAN.
 - ALL UTILITIES ARE FROM DESIGN PLANS PROVIDED BY URS.

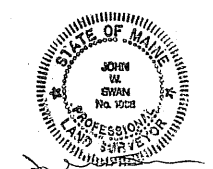

JOHN W. SWAN, PLS NO. 1038
DATE 4/9/12

SITE PLAN
OF
LOT 16 - 11 BALLPARK DRIVE, PORTLAND, MAINE
MADE FOR
THE VESTA CORPORATION
P.O. BOX 1464, PORTLAND, MAINE 04104

OWEN HASKELL, INC.
390 U.S. ROUTE ONE, FALMOUTH, ME 04105 (207) 774-0424
PROFESSIONAL LAND SURVEYORS

Drwn By OHI	Date APRIL 9, 2012	Job No. 2012-048P
Trace By JLW	Scale	Drwg. No.
Check By JWS	1" = 10'	1
Book No. 1010		

