

1-877-362-3409

PLEASE READ ASSEMBLY
INSTRUCTIONS COMPLETELY
BEFORE STARTING

Instructions made easy

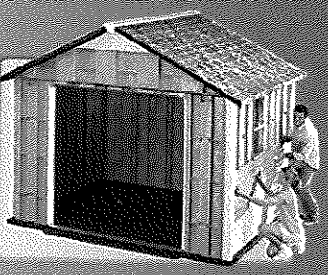
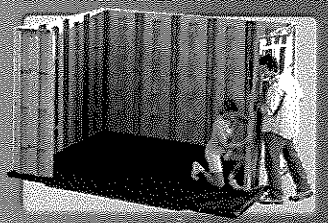
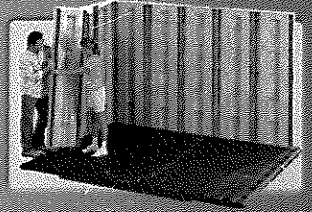

Homestyles™

outdoor storage

www.homestylesshed.com

Product of the US Fence Company · Flint, Michigan 48506

Stage 1 - Floor

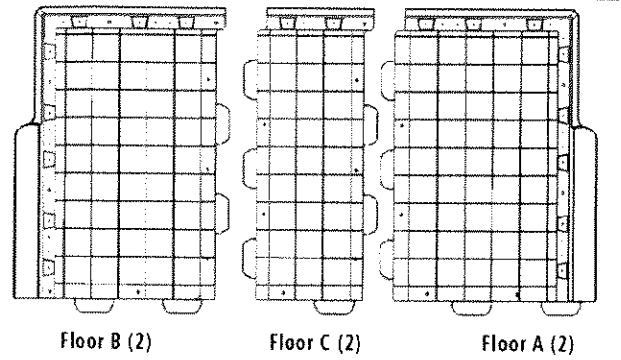

Stage 5 - Doors

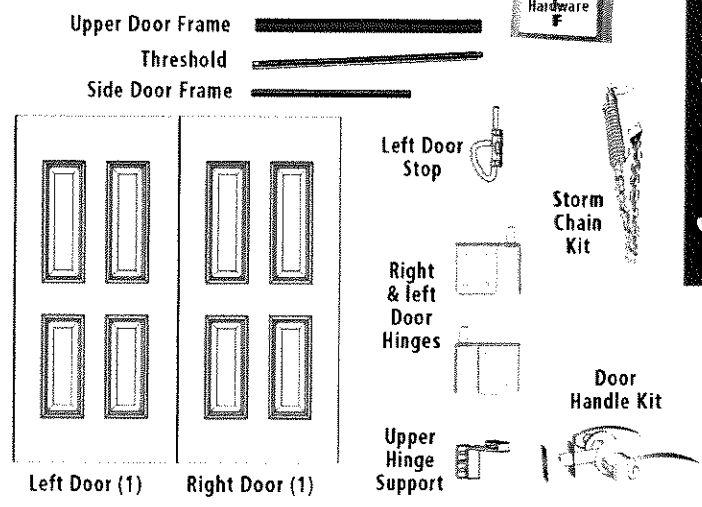

Stage 2 - Walls

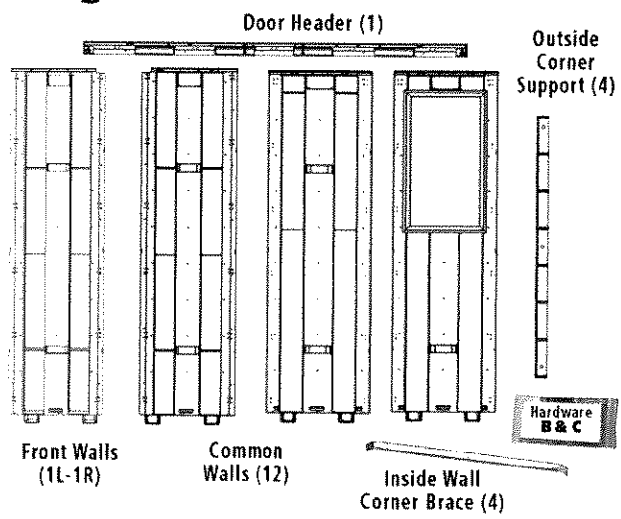

Stage 6 - Siding

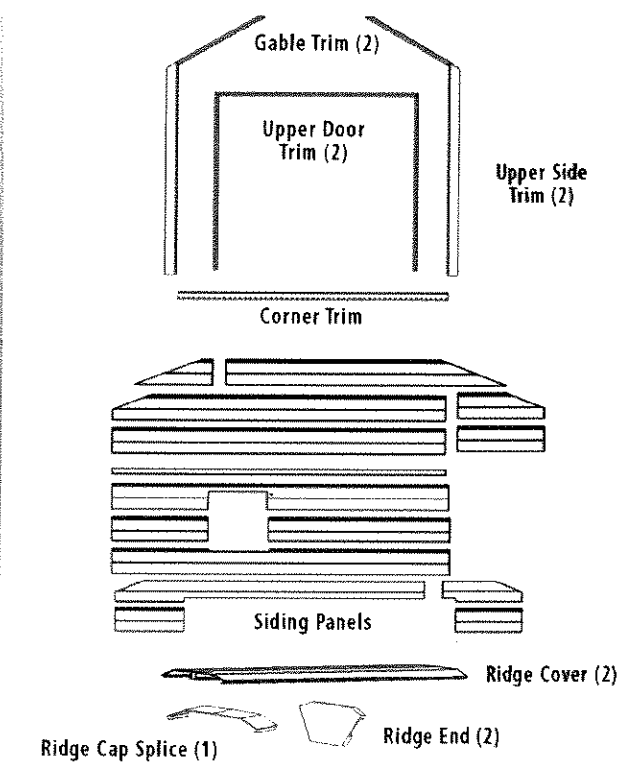

Stage 3 - Gables

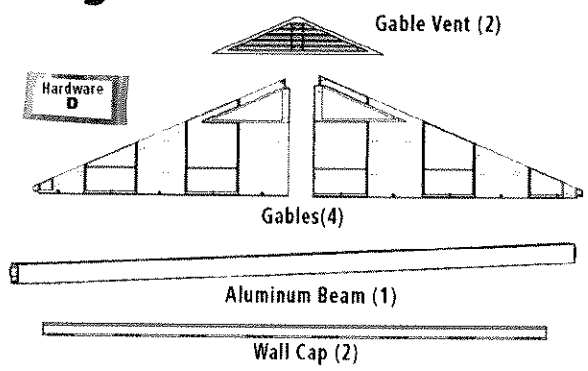

Stage 4 - Roof

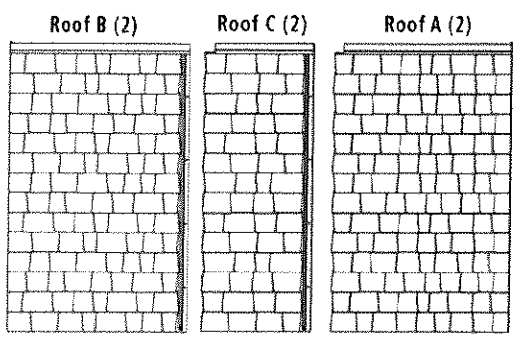
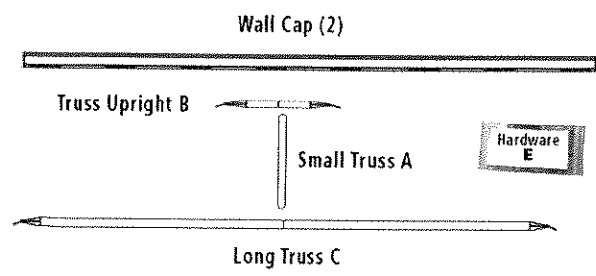
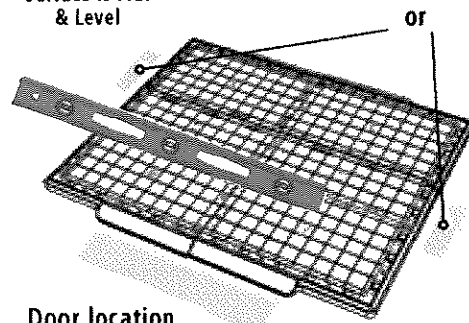

Table of Contents

Stage 1	<i>Floor</i>	4
Stage 2	<i>Walls</i>	6
Stage 3	<i>Gables</i>	10
Stage 4	<i>Roof</i>	14
Stage 5	<i>Doors</i>	18
Stage 6	<i>Siding</i>	24
Stage 7	<i>Securing Shed To Base</i>	28

Door Assembly -
Stage 4
Requires that the
Surface is Flat
& Level

Window location options



**Door Assembly
Requires that the
Floor is Flat & Level**

Shed Assembly Tools Required: Phillips head screwdriver or electric screwdriver, Drill Bits -1/8"- 1/4"- 3/8", Level, Molded Wrench Tool or Socket Wrench, 7/16" & 9/16" wrenches, Small rubber mallet

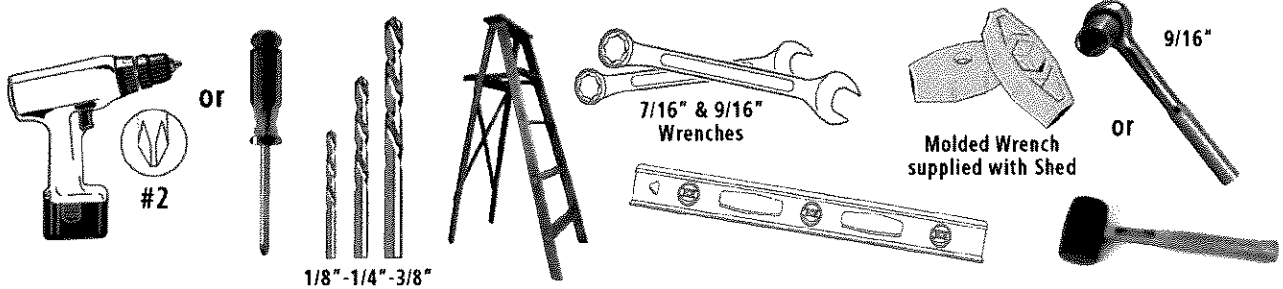

Stage 1 Floor

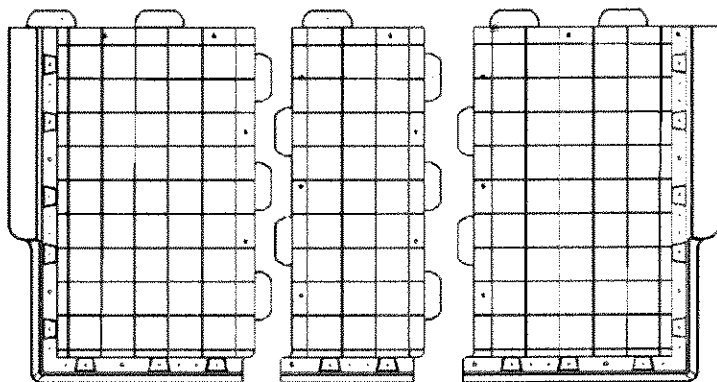

Floor A (2)

Floor C (2)

Floor B (2)

Thread Fastener Bag "A"

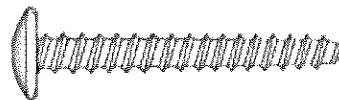

(30)- 1/4"x2" Coarse Thread

Tools Needed:

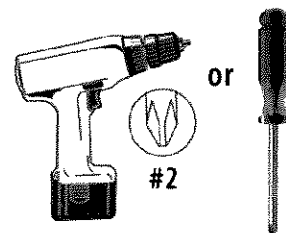

1 Floor Assembly

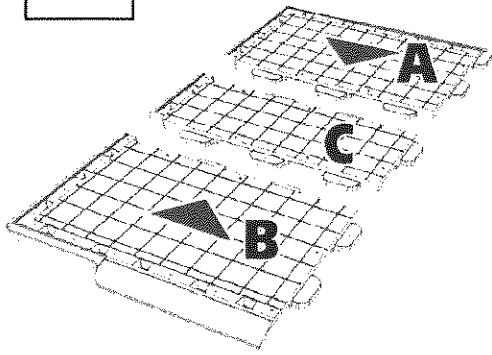

2

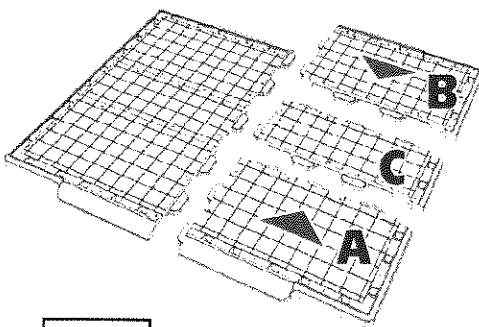

3

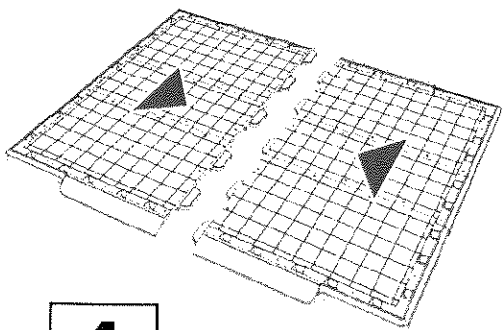

4

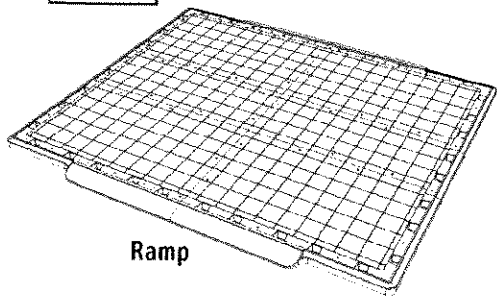

5

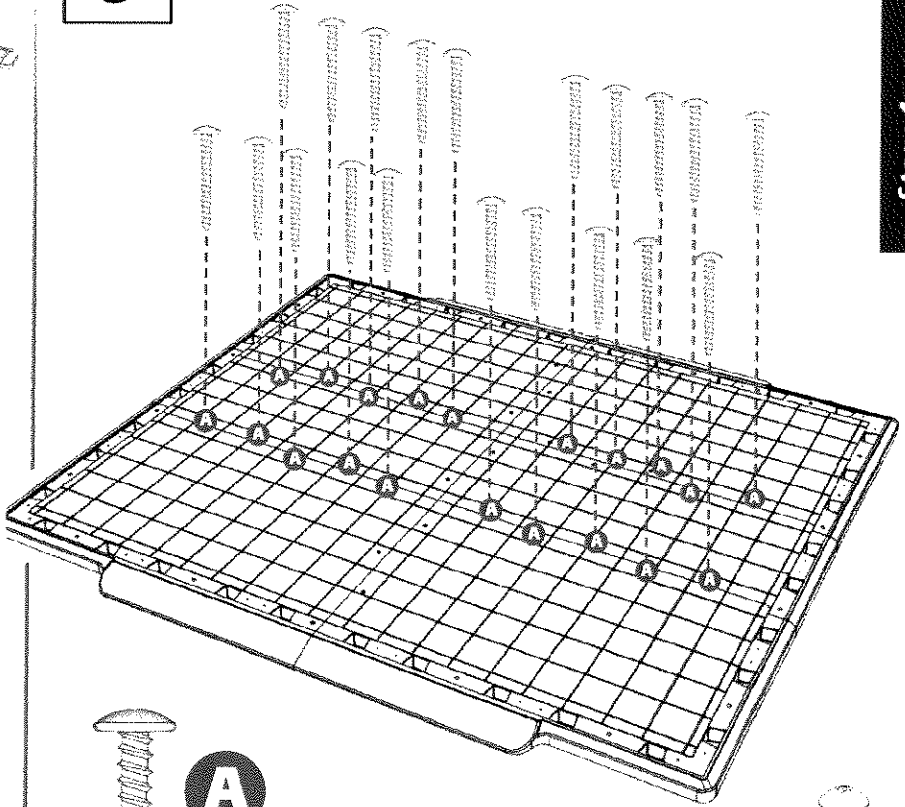

A



Do Not Overtighten

(30)- 1/4"x2"
Coarse Thread

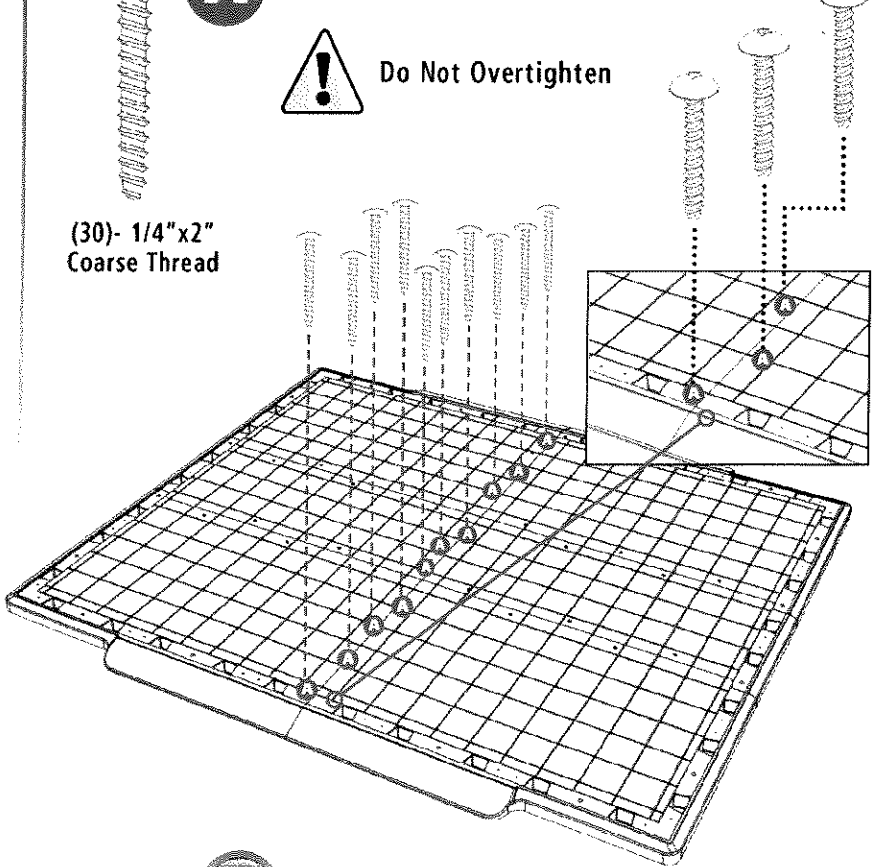

Style and durability made easy
Homestyles.
outdoor storage

Stage 2 Walls

Door Header (1)

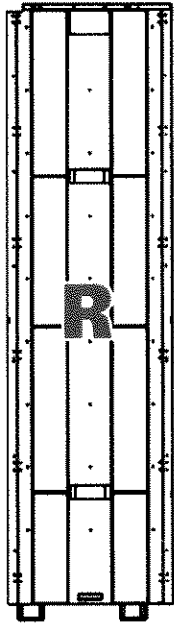
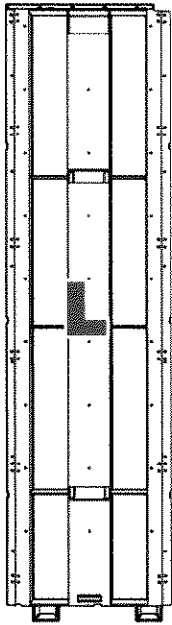
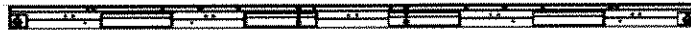

Front Walls
(1L-1R)

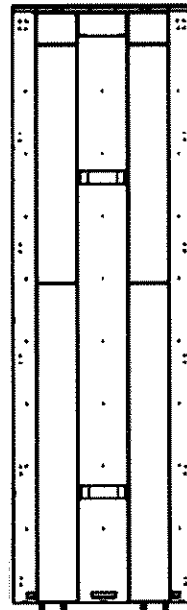

Common
Walls (12)

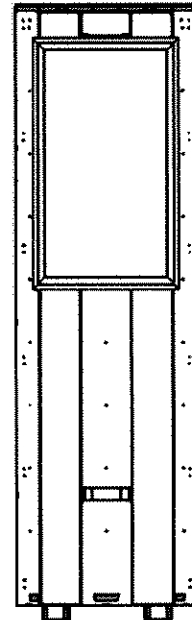

Window
Wall (1)



Inside Wall
Corner Bracket (4)



Outside
Corner
Support (4)

Fastener Bag "B"

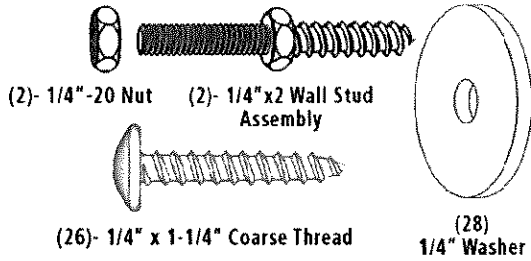

Fastener Bag "C"

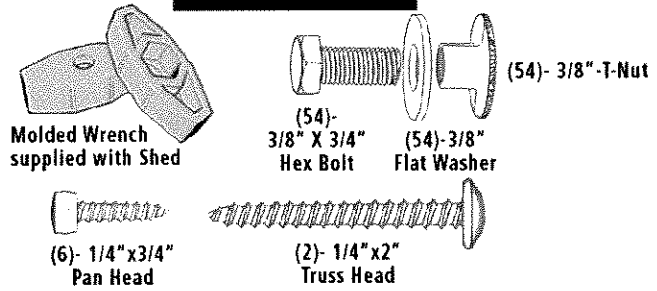

Tools Needed:

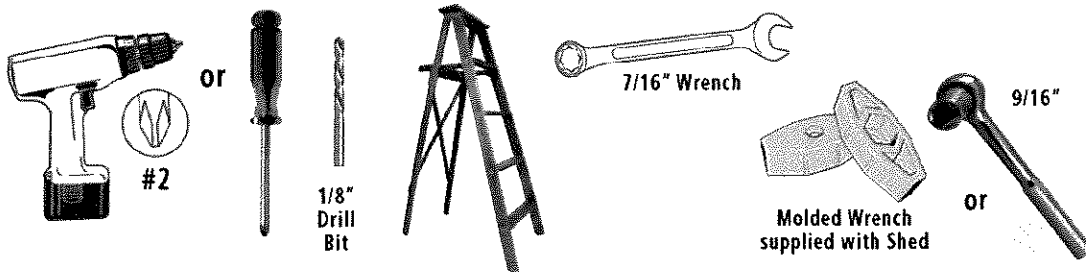

6 Front Wall Stud Assembly

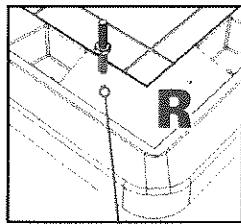
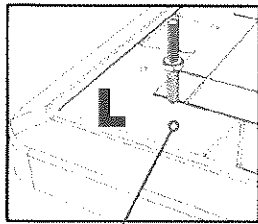

Tighten until nut is flush with floor

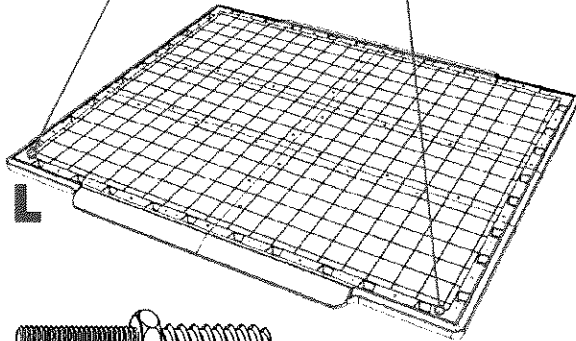

(2)- 1/4" x 2" Wall Stud Assembly

7 Wall Assembly



Place Left & Front Corner Panels

Common Wall Panel

Left Front Wall Panel

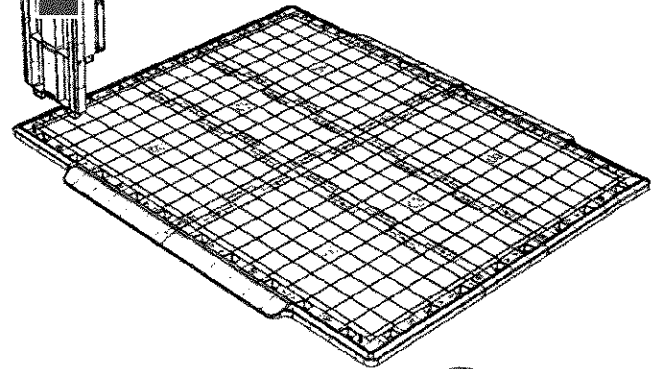

8 Place Corner Supports

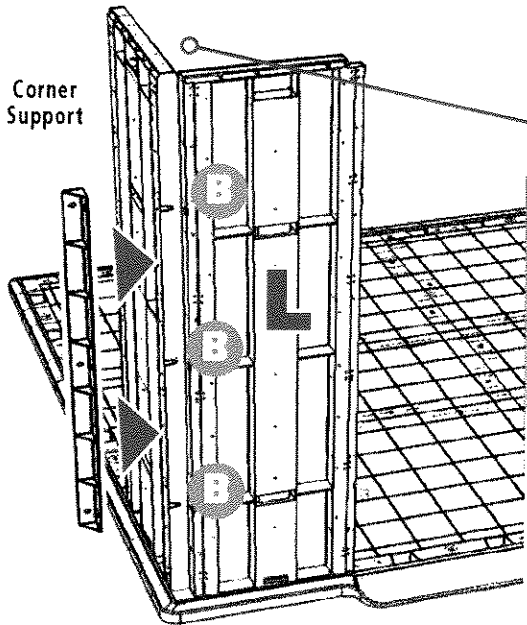

Corner Support

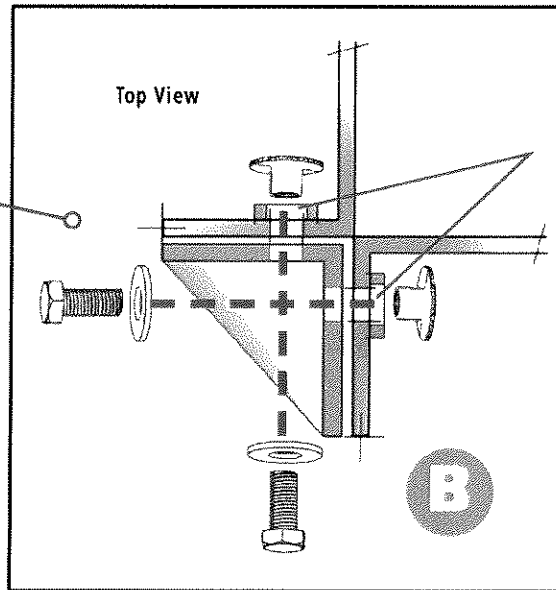

Top View

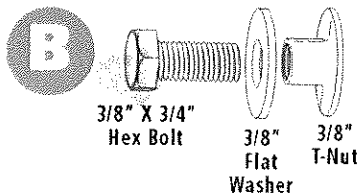

3/8" X 3/4" Hex Bolt

3/8" Flat Washer

3/8" T-Nut

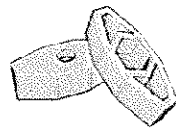

Molded Wrench supplied with Shed



Do Not Overtighten



Style and durability made easy
Homestyles.
outdoor storage

9

Place remaining Three Corner Panels
Secure Corner Supports

B

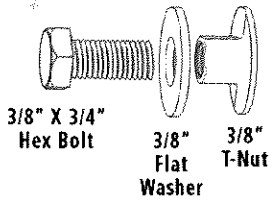

3/8" X 3/4"
Hex Bolt

3/8"
Flat
Washer

3/8"
T-Nut

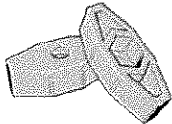

Molded Wrench
supplied with Shed

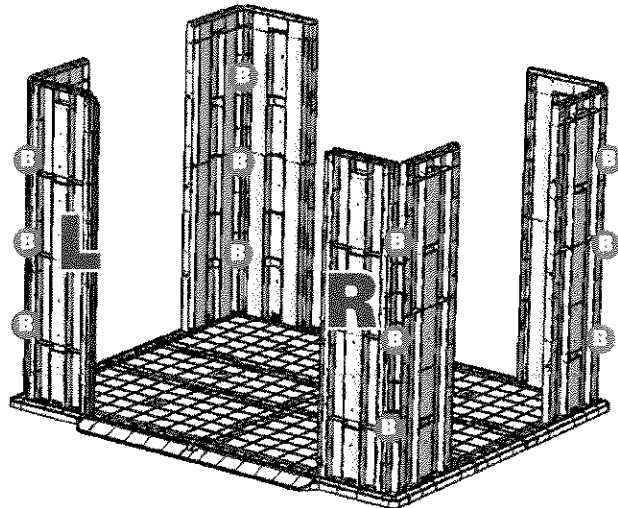

10

Place Six (6) Walls and
One(1) Window Wall into
Position

Window
Wall

Window can be installed
in either location.



Warning Siding Is
Specifically Cut To
Accomodate Either Of
These Two Window
Locations Only!

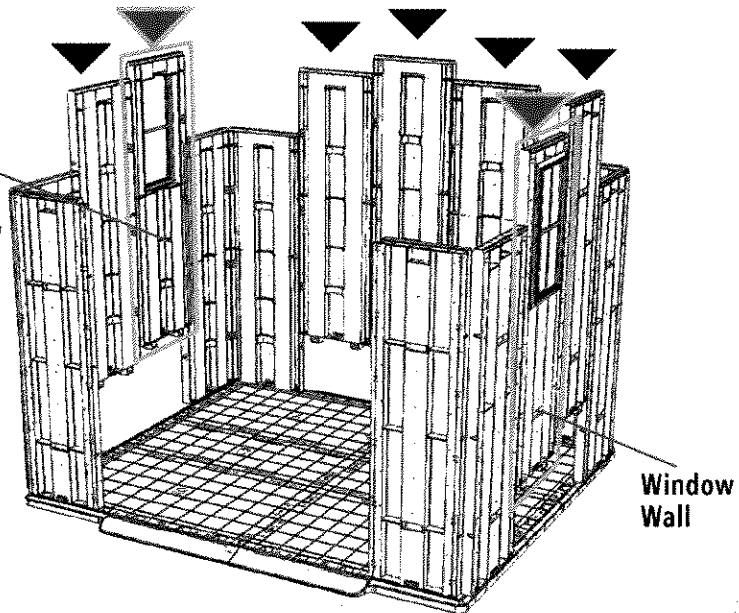

11

Secure Wall to Wall



Hint

B

Homestyles Handyman Hint:

Snap all 3/8" T-Nuts into hole
prior to inserting hex bolt.

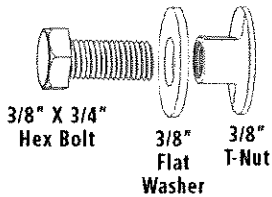

3/8" X 3/4"
Hex Bolt

3/8"
Flat
Washer

3/8"
T-Nut



Molded Wrench
supplied with Shed

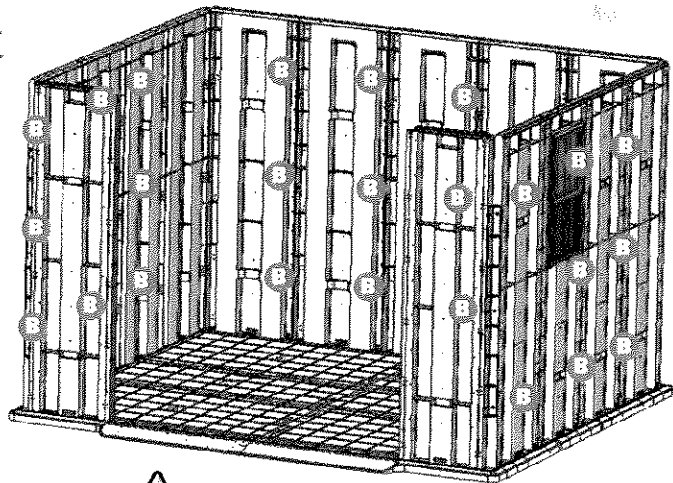
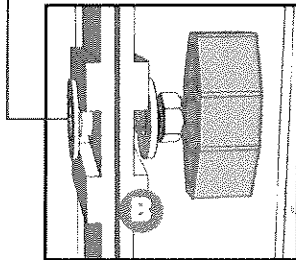

Do Not Overtighten



Style and durability made easy
Homestyles.
outdoor storage

12 Secure Wall to Floor

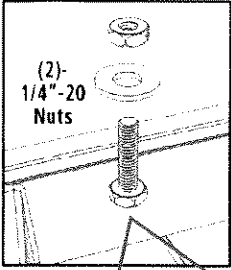

! Do Not Overtighten

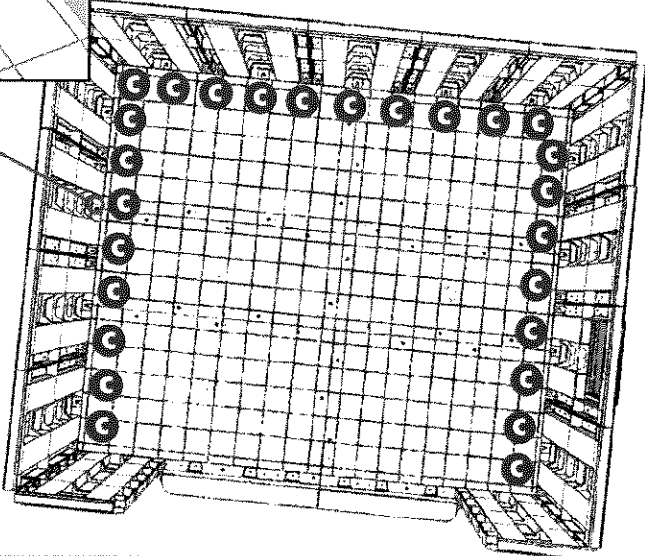
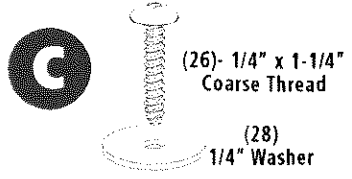
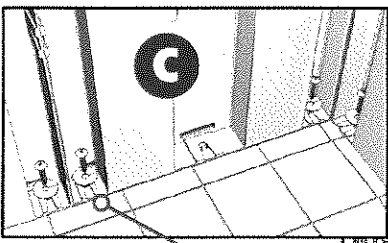
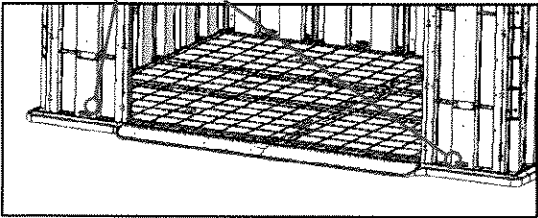

13 Attaching Front & Rear Corner Brackets and Door Header

Front Corner Brackets

Attach one side of front corner bracket to door header. Attach the other side of bracket to the wall 1-1/4" back from the edge of wall pocket. Pre drill 1/8" hole then fasten. Repeat for other front corner bracket.

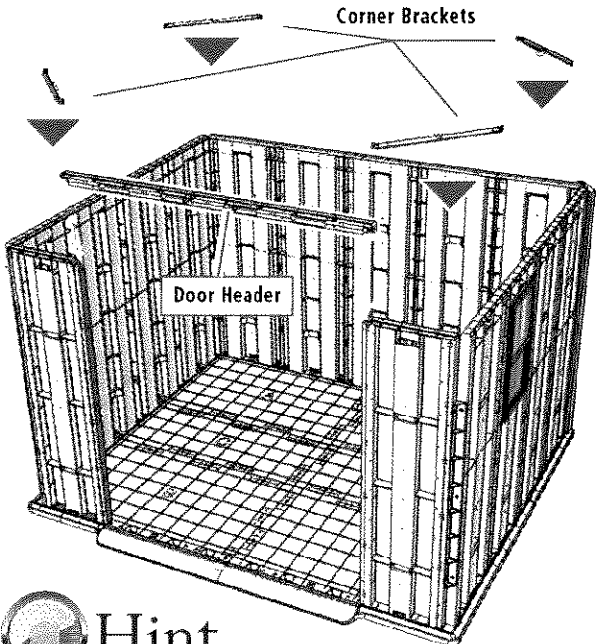
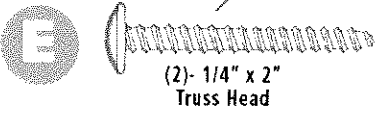
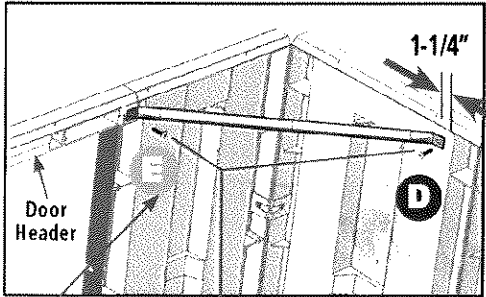

Rear Corner Brackets

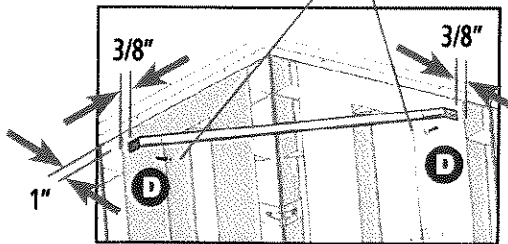

Place rear corner bracket 1" down from top of wall and 3/8" from edge of wall pocket and pre-drill 1/8" hole. Attach to wall one side at a time. Repeat for other rear corner bracket.

Hint

Homestyles Handyman Hint:
Attaching brackets at these dimensions will square up your shed. If you have difficulty attaching the brackets to these specifications please check to make sure your floor is level.

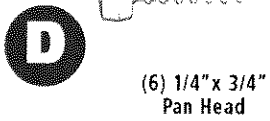

Stage 3 Gables

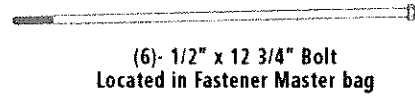
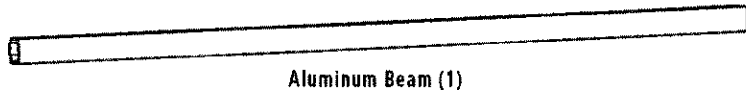
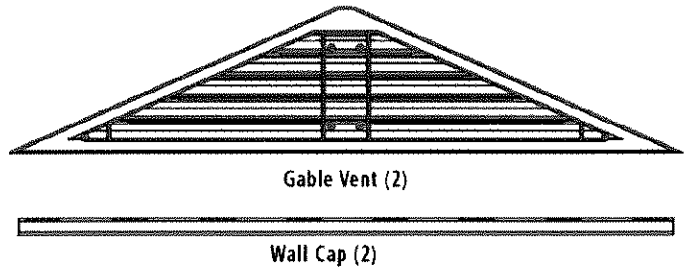
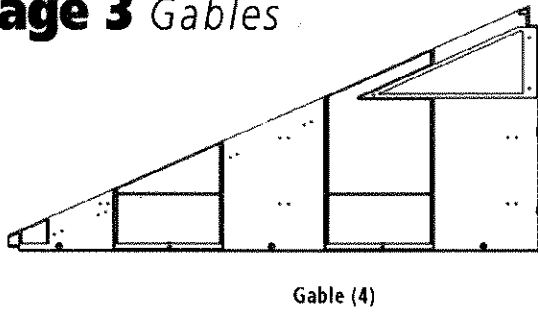

Fastener Bag "D"

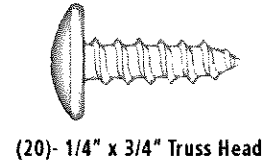
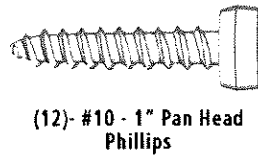
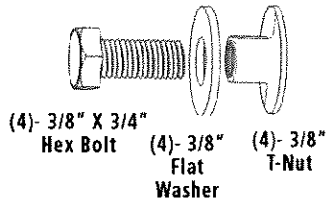

Tools Needed:

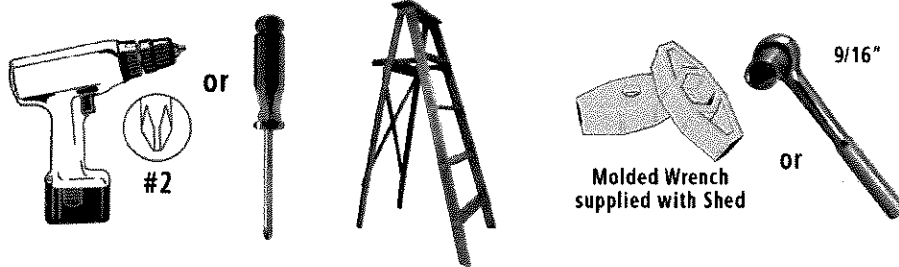

14

Assemble Gable Ends

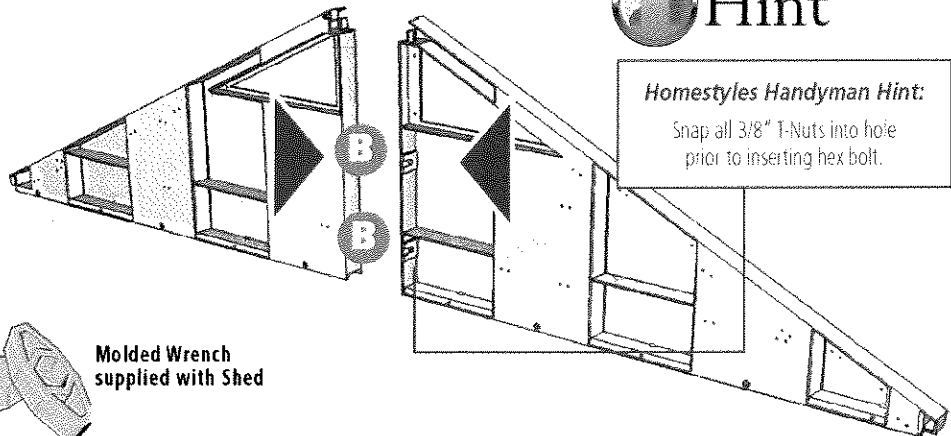
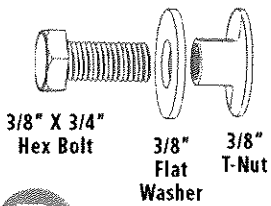

Homestyles Handyman Hint:

Snap all 3/8" T-Nuts into hole prior to inserting hex bolt.

15 Attach Vent

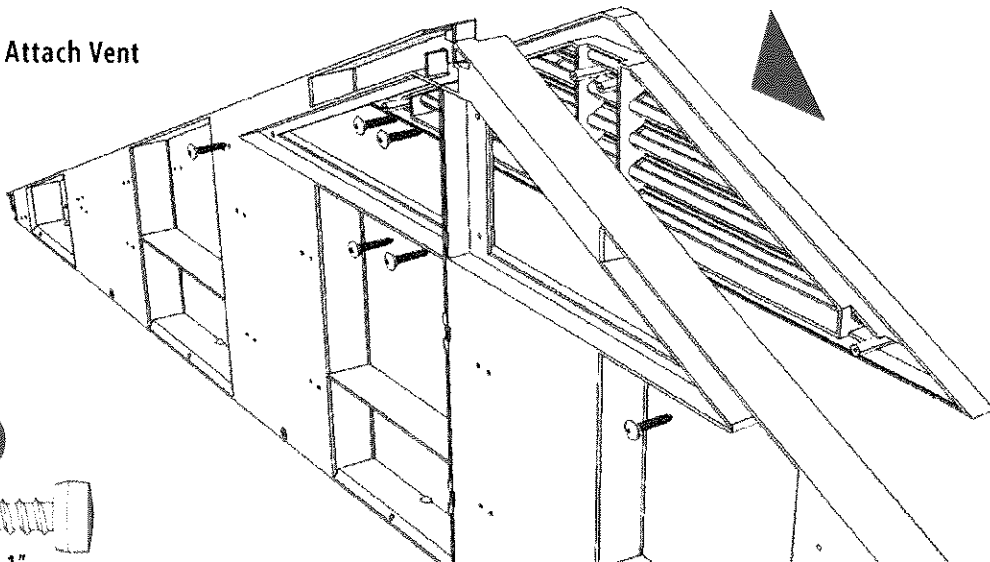

F

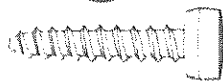

(12)- #10 - 1"
Pan Head Phillips

*Homestyles
Handyman Hint:*
Do not tighten vent screws.
Leave loose and tighten after
Last siding panels are in place.
(762 Front and Rear)

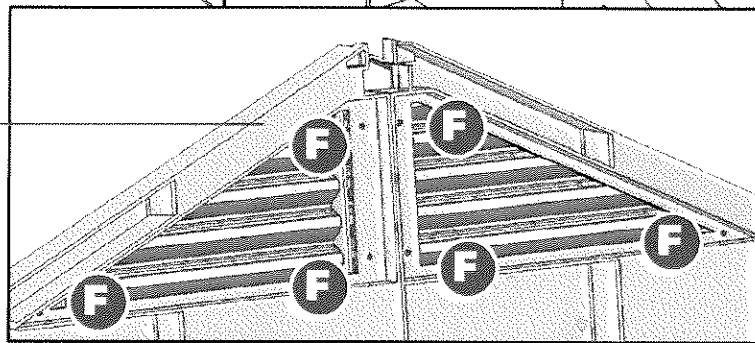

16 Position Two (2)
Wall Caps Front &
Rear with access holes
toward the interior

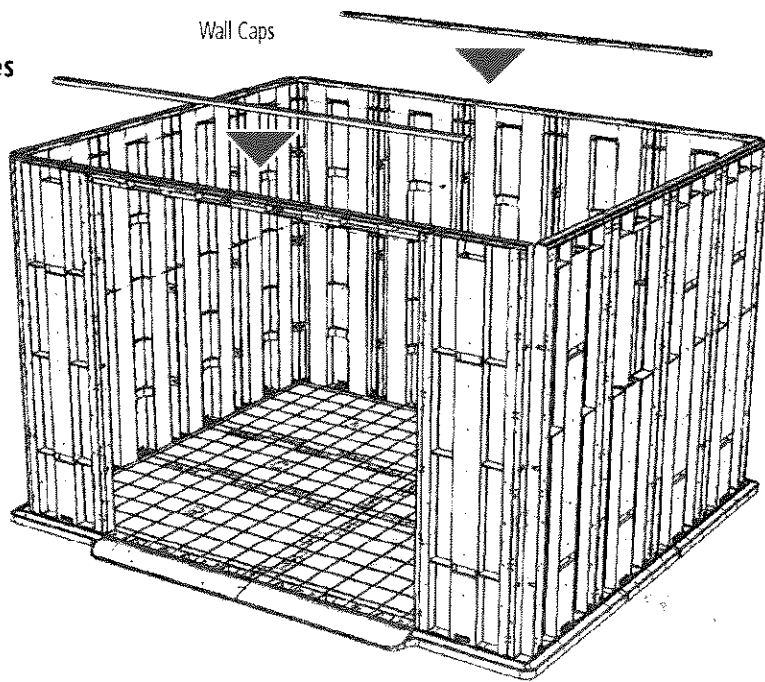

17

Position, But Do Not Fasten the Two (2) Wall Caps (Front & Rear) With Access Holes Toward The Interior

Front Wall Cap
First Inside Hole
(Right Side Shown)

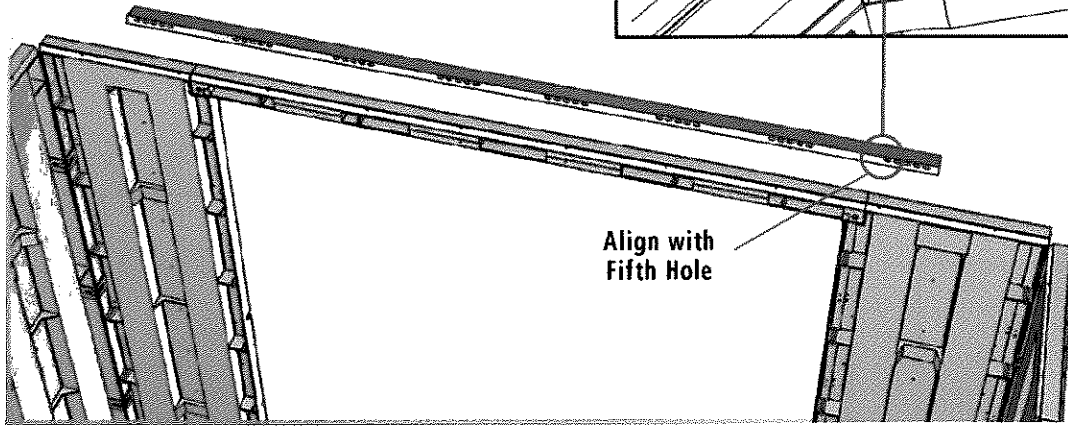
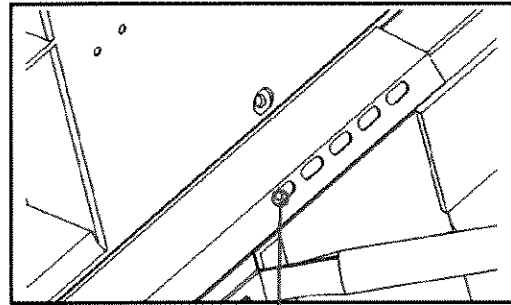

Rear Wall Cap First
Inside Hole
(Right Side Shown)

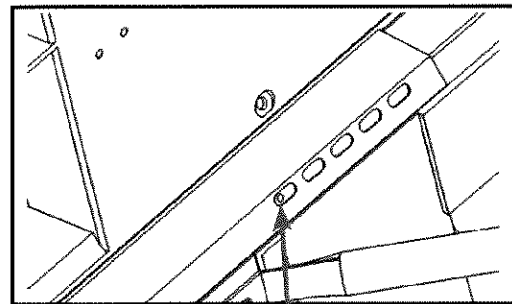

Align with
Fifth Hole

18 Position Assembled Gables on Front and Rear Walls

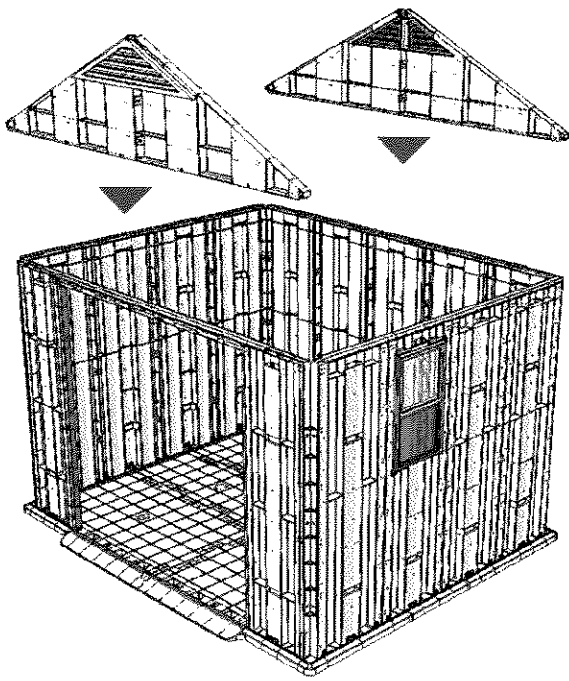

19 Secure Gables to Walls

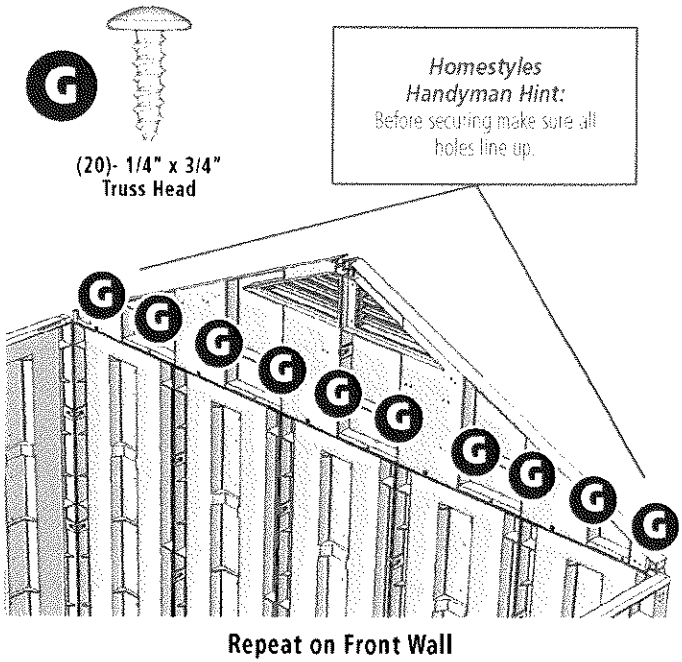

20 Slide (6)- 12-3/4" Bolts into Place from the End of the Aluminum Beam

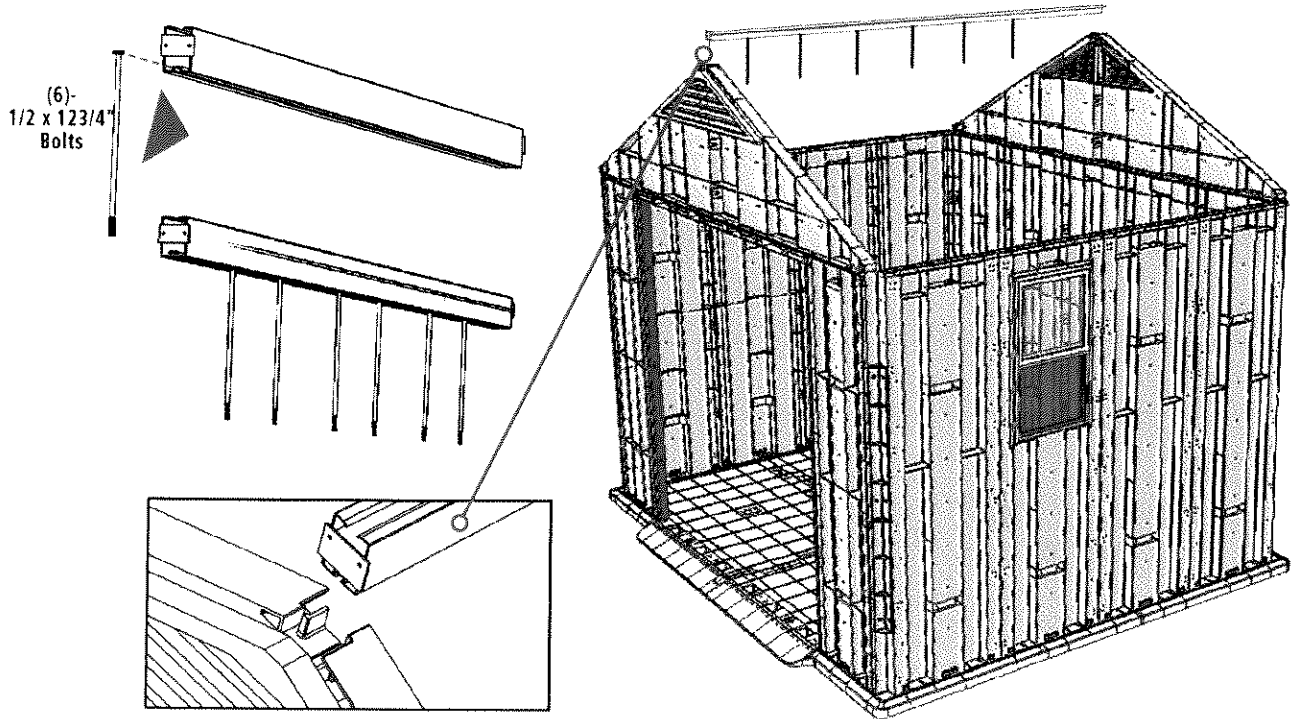

Stage 4 Roof

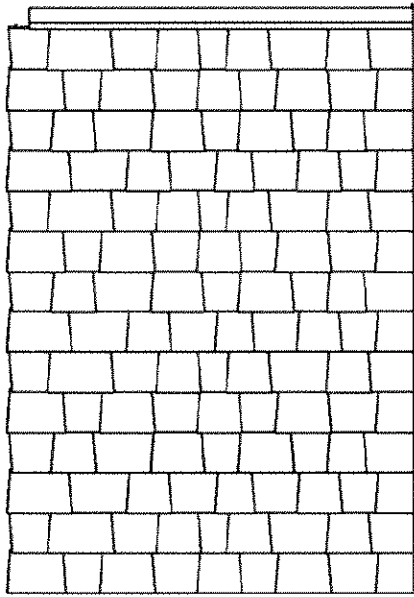

Roof A (2)

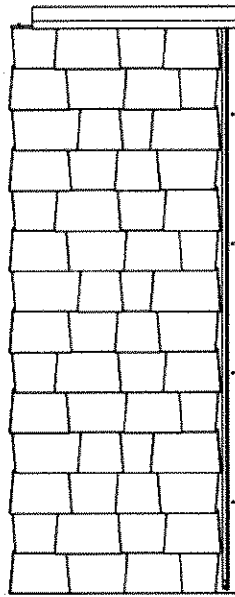

Roof C (2)

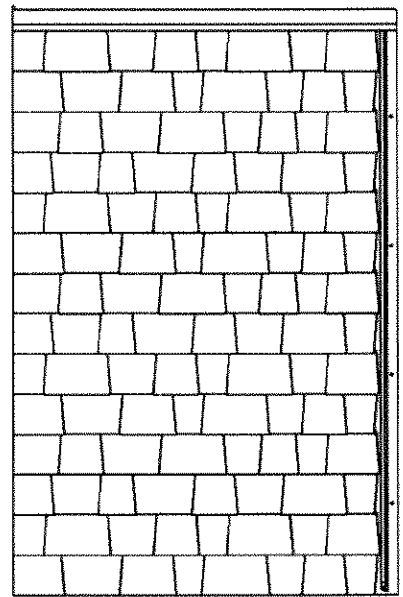

Roof B (2)



Wall Cap (2)

Roof - Truss

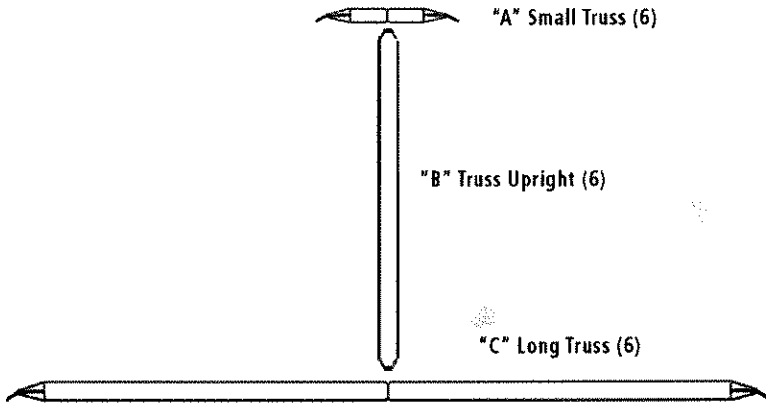

Fastener Bag "E"

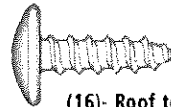

(16)- Roof to Walls
1/4" x 3/4" Truss Head

(16)- Roof to Roof
1/4" x 3/4" Truss Head

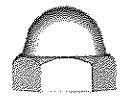

(6)- Acorn Nut

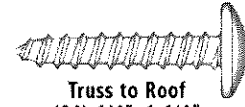

Truss to Roof
(24)- 1/4" x 1-1/4"
Truss Head

Tools Needed:

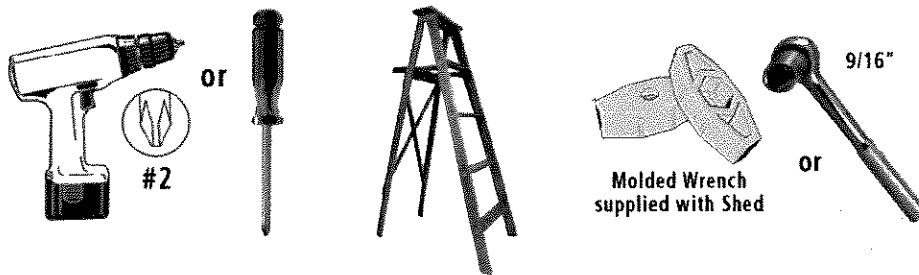

21 Position Two (2) Wall Caps
Left and Right (Window
Side) with access holes
toward the interior

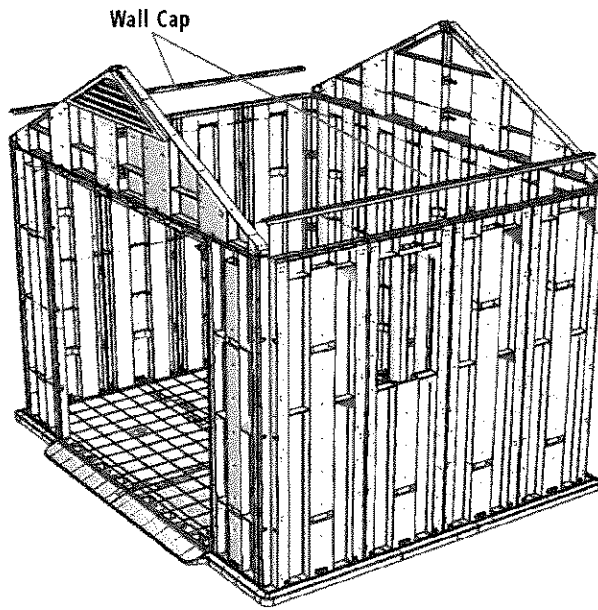

22 Place Roof Panels

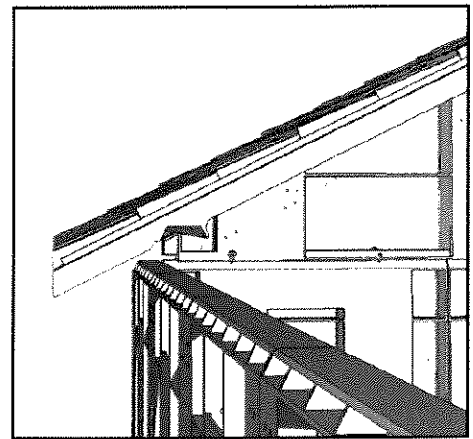
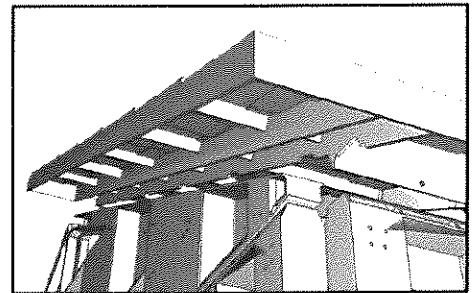
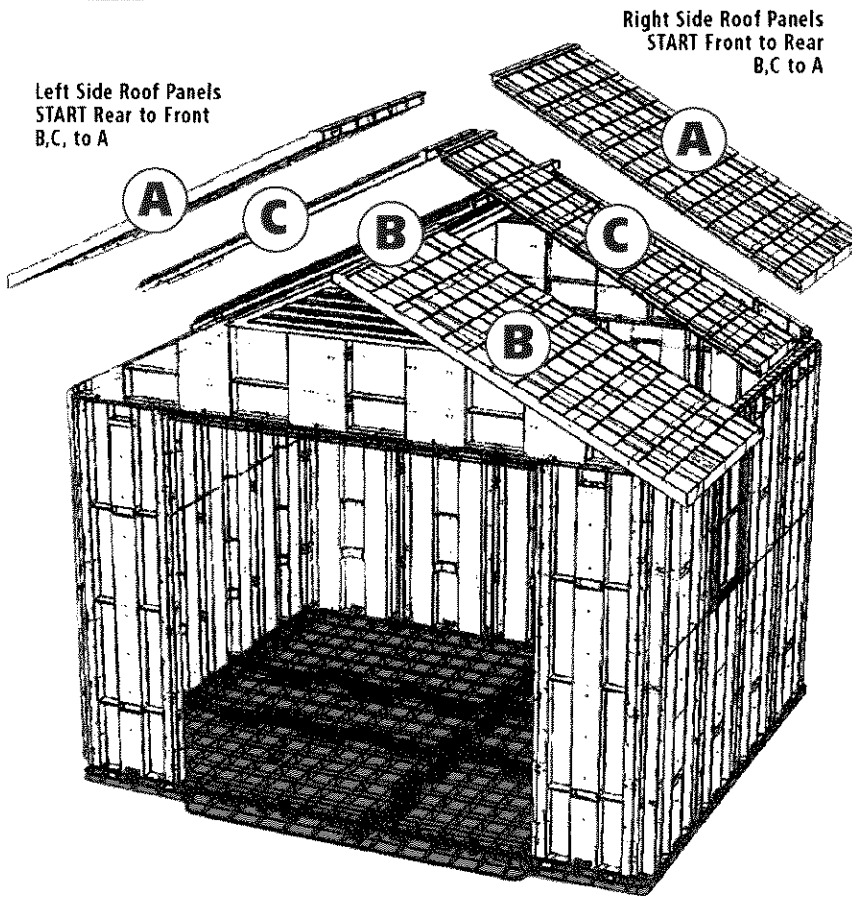

23

Fasten Roof Panels to Walls

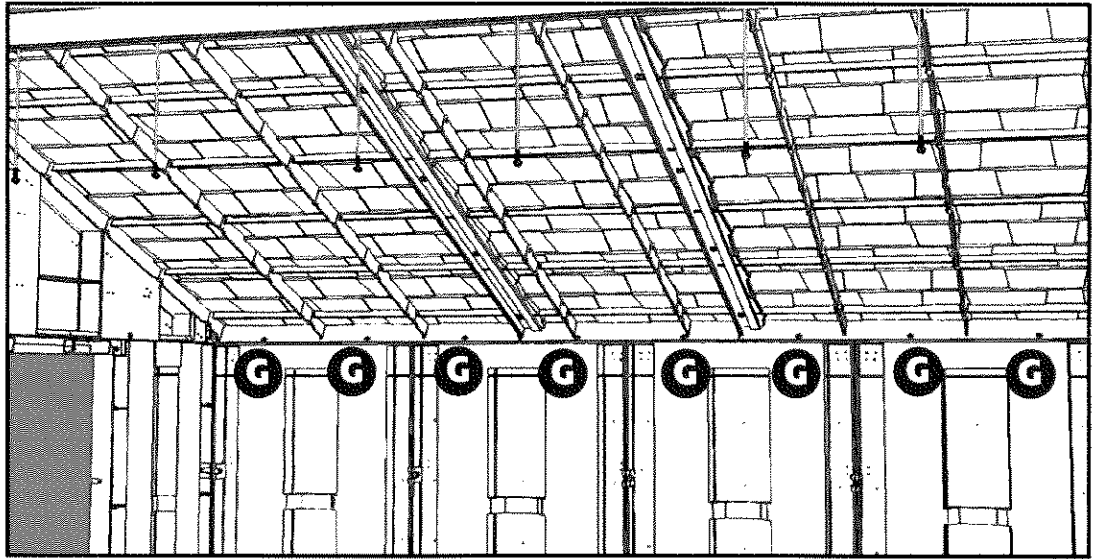
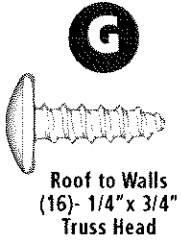

Repeat for other side.



Do Not Overtighten

24

Roof Panel to Roof Panel

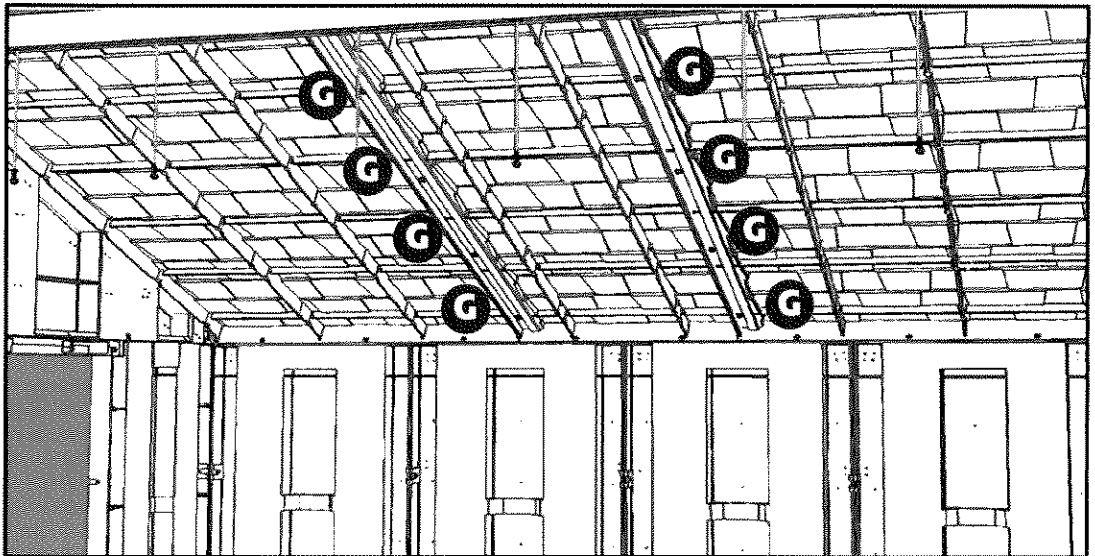
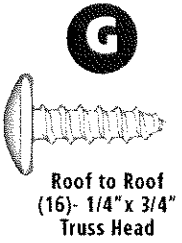

Repeat for other side.



Do Not Overtighten

25

**Push Truss Components
A,B,C on to 12-3/4" Bolts**



Hint

Homestyles Handyman Hint:
Slide Small Truss "A" On Bolt And Attach To Roof First Using 1/4" X 1-1/4" Truss Head Screw. Then Truss Upright "B" And Long Truss "C" will bolt together easily.

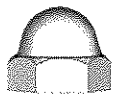

(6)- Acorn Nut

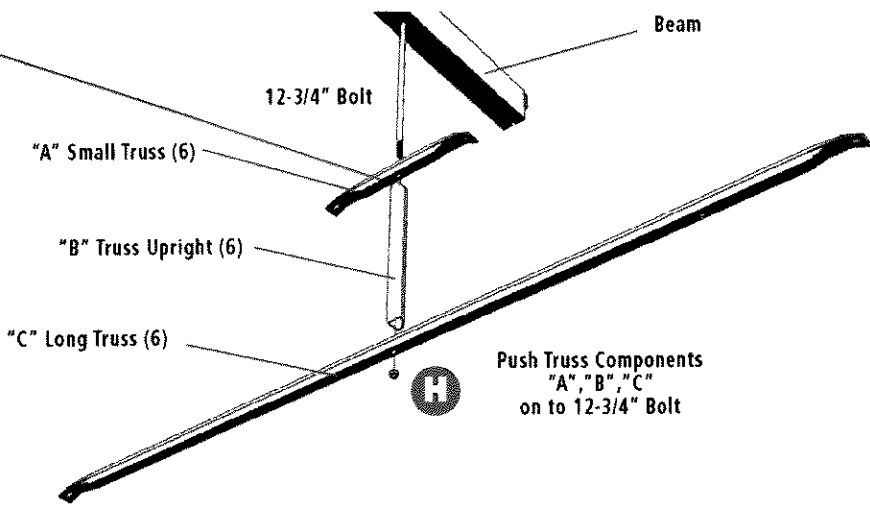

26

Truss to Roof Attachment Points



Truss to Roof
(24)- 1/4" x 1-1/4"
Truss Head

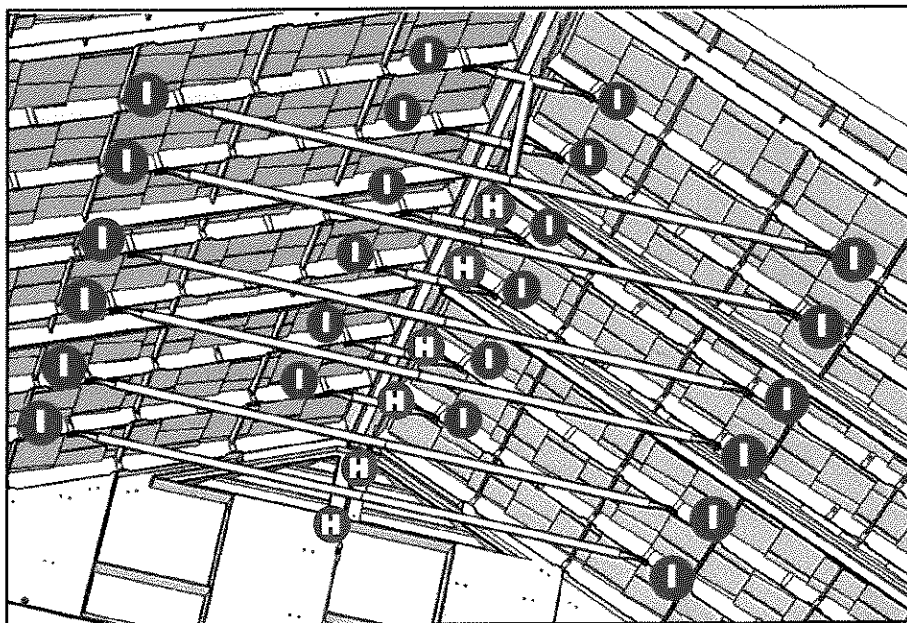

Do Not Overtighten



Style and durability made easy
Homestyles.
outdoor storage

Stage 5 Doors



Threshold (1)

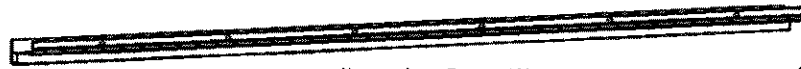

Upper door Frame (1)

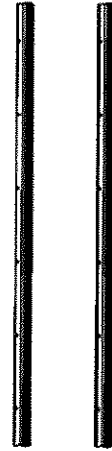

Side Door frame (1R -1L)

Fastener Bag "F"

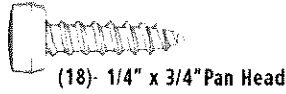

(18)- 1/4" x 3/4" Pan Head

(2)- 1/2" -O.D. Bronze Bushing Stage



(6)- 1/4" x 1 1/4" Truss Head

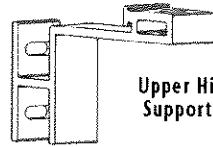

Upper Hinge Support (2)



Left Door Stop (1)

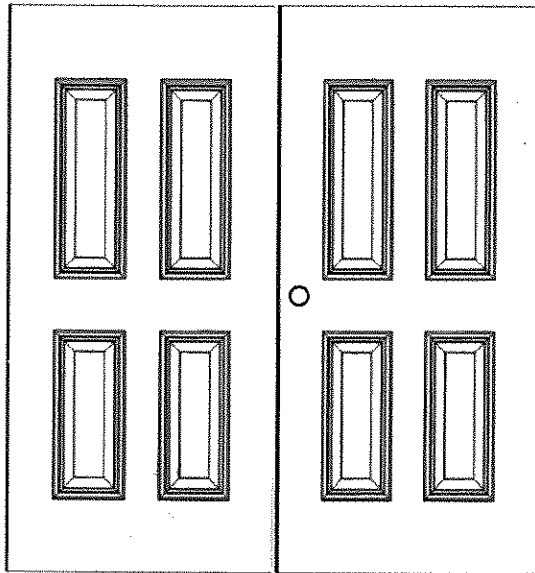

Door Left (1)

Door Right (1)

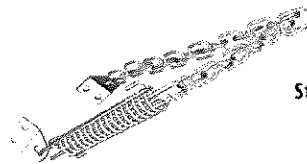

Storm Chain Kit (2)



Left Door Bolt (2)

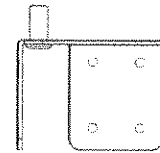

Door Hinge Upper (2)



Door Handle Kit

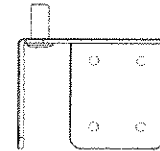

Door Hinge Upper (2)

Fastener Bag "G"



(4)- 3/8" ID x 5/8" OD Nylon Washer 1/8" Thick



(32)- #10-1" Countersunk Phillips

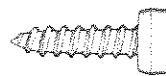

(9)- #10-1/2" Pan Head Phillips

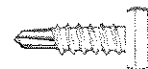

(4)- #10-1/2" Self Drilling Pan Head

Tools Needed:

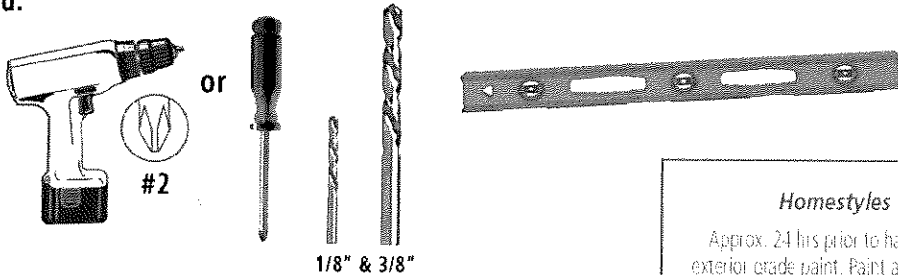

Homestyles Handyman Hint:

Approx. 24 hrs prior to hanging doors, Select a suitable, exterior grade paint. Paint all six (6) sides of each door, prior to attaching hardware.

27 Slide Upper Hinge Supports into Upper Door Frame Approximately 6" but DO NOT ATTACH.

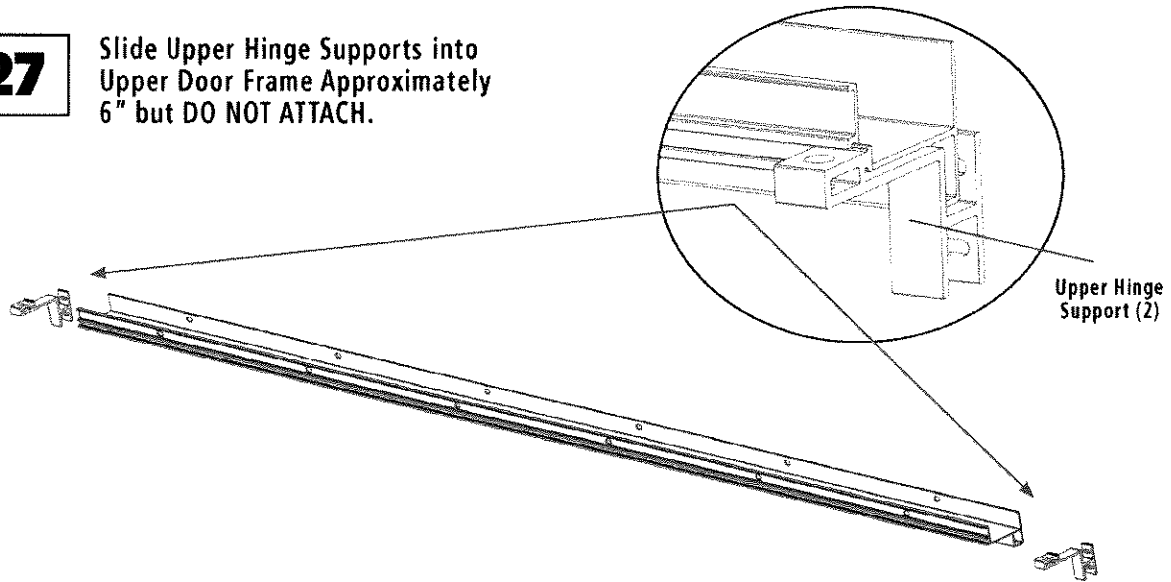

28 Place Upper Door Frame into position on the Header

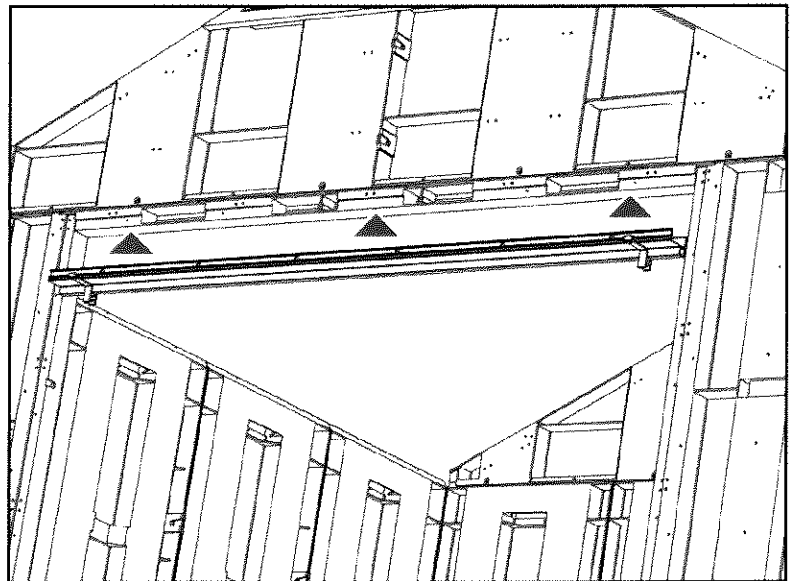

29 Secure Upper Door Frame to the Header

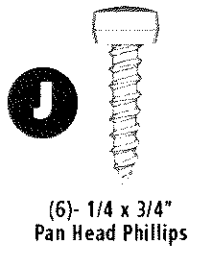

 Do Not Overtighten



30

Position Threshold On Floor but DO NOT ATTACH.

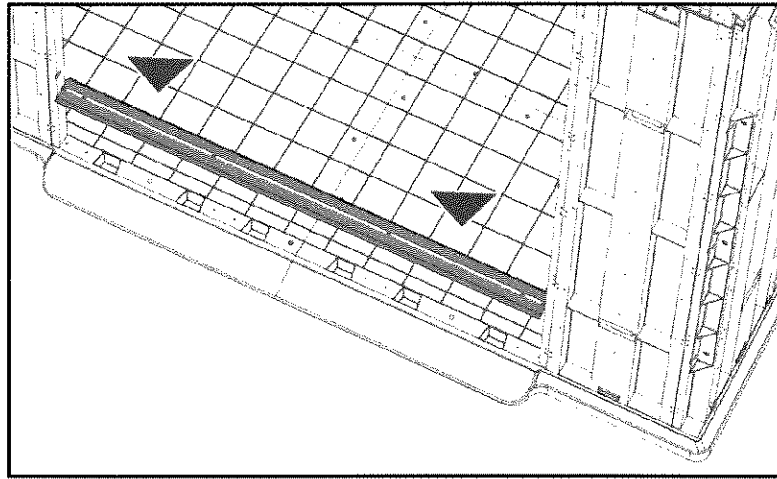

31

Position Door Side Frames into Position Right & Left

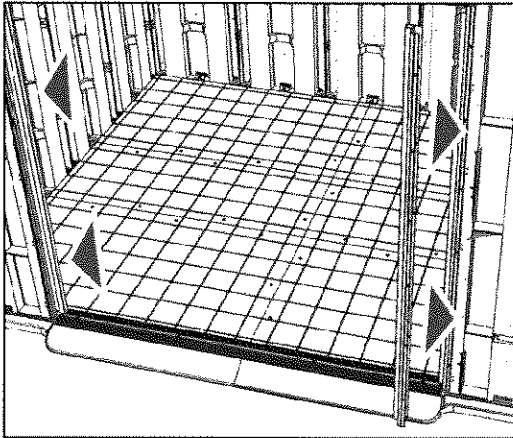

32

Secure Door Side Frames to the Right & Left Wall

K

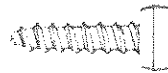

(12)- 1/4" x 3/4" Pan Head

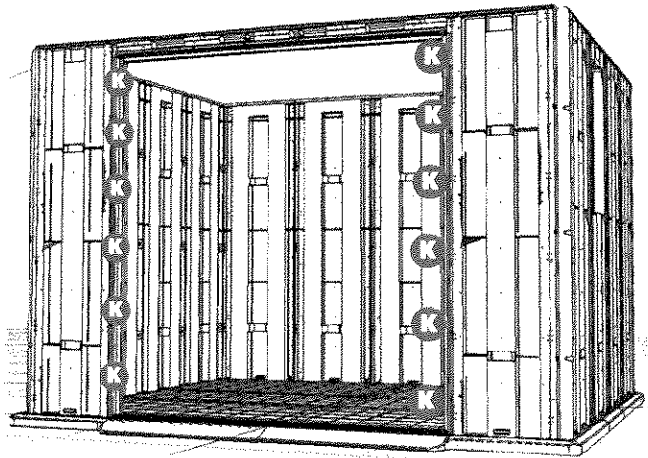

33

Secure Threshold to the Floor

L

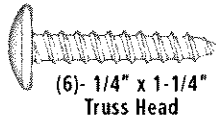

(6)- 1/4" x 1-1/4" Truss Head

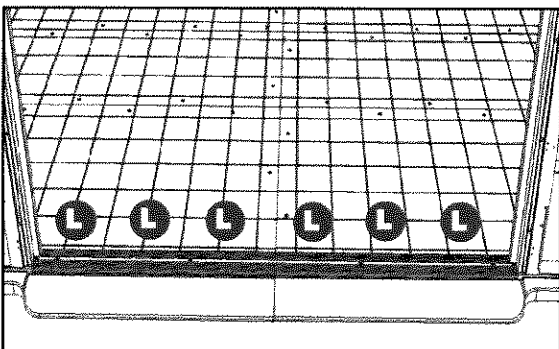

34

Place Bronze Bushings into Door Threshold on Each Side.

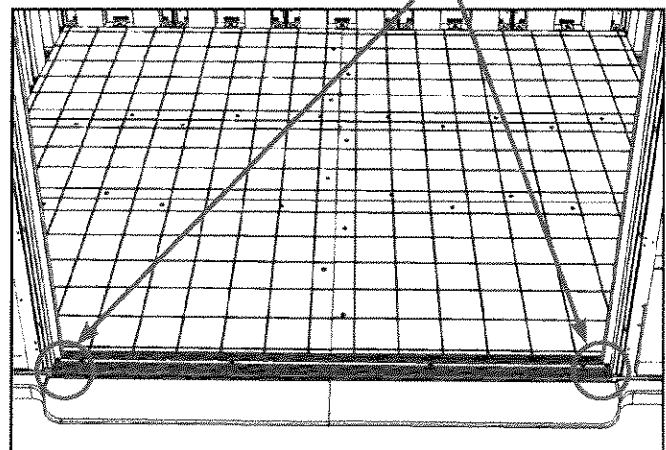
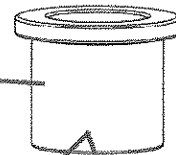

35

Left Door Stop

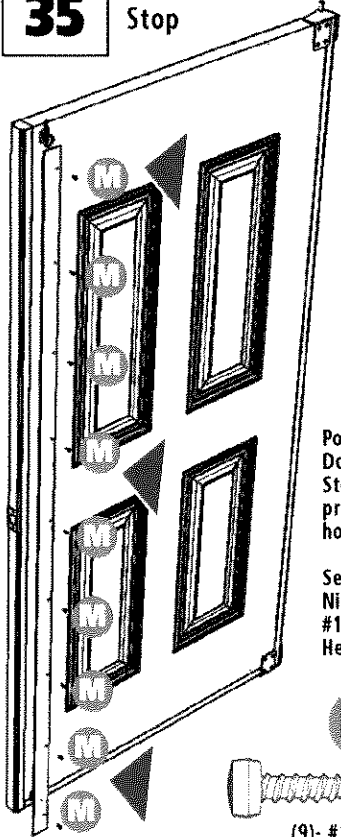

Position Door Stop over pre-marked holes.

Secure with Nine (9) #10-1/2" Pan Head Screws

(9)- #10-1/2" Pan Head

36

Position Hinge Lower Outside of Doors

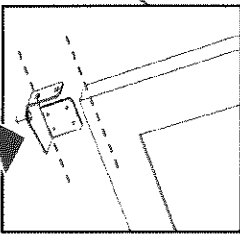
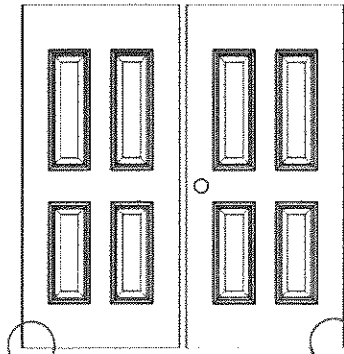

Position Hinge on Lower Outside of Door

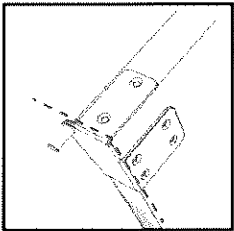

Secure Hinge to Door Sequence

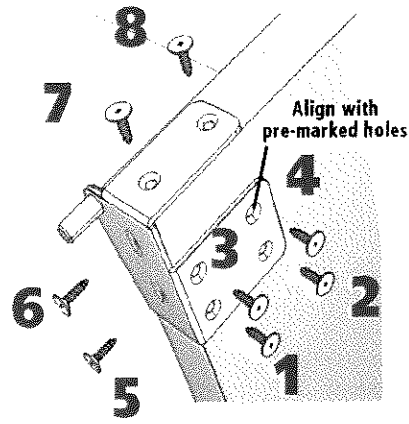

Align with pre-marked holes

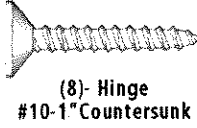

(8)- Hinge #10-1" Countersunk

Align Outer Edge of Door with inside of Hinge

37

Position Upper Hinge into Upper Hinge Support

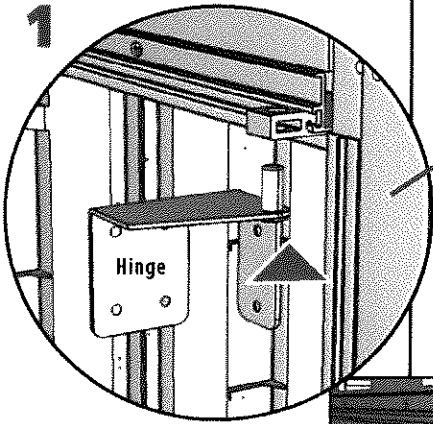

Slide door into Hinge

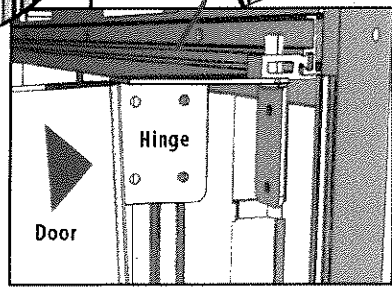

Door

38

Position Lower Hinge into Threshold Hinge Bushing

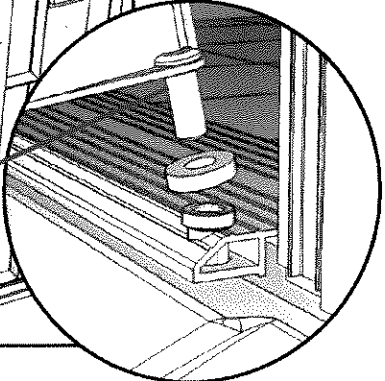

Nylon Washer to Bottom Hinge Pin



1 over ea. Hinge Pin
3/8" ID x 5/8" OD Nylon Washer 1/8" Thick

39

Secure Hinge to Door Sequence



Hint

Homestyles Handyman Hint:

Pre drill holes on #7 & 8 with a 1/8" drill bit before fastening.

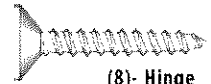
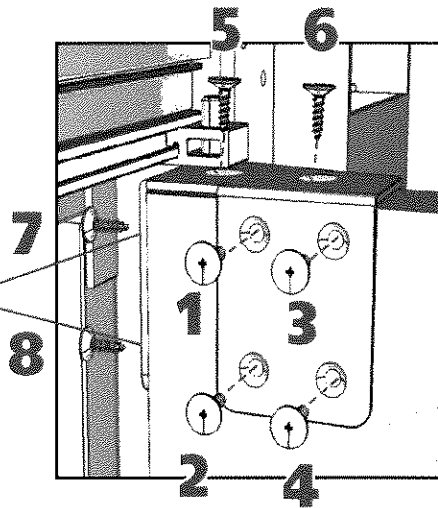

(8)- Hinge #10-1" Countersunk

40

Door Alignment

Close doors

Secure Door Hinge Support in Perpendicular Position

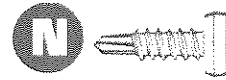
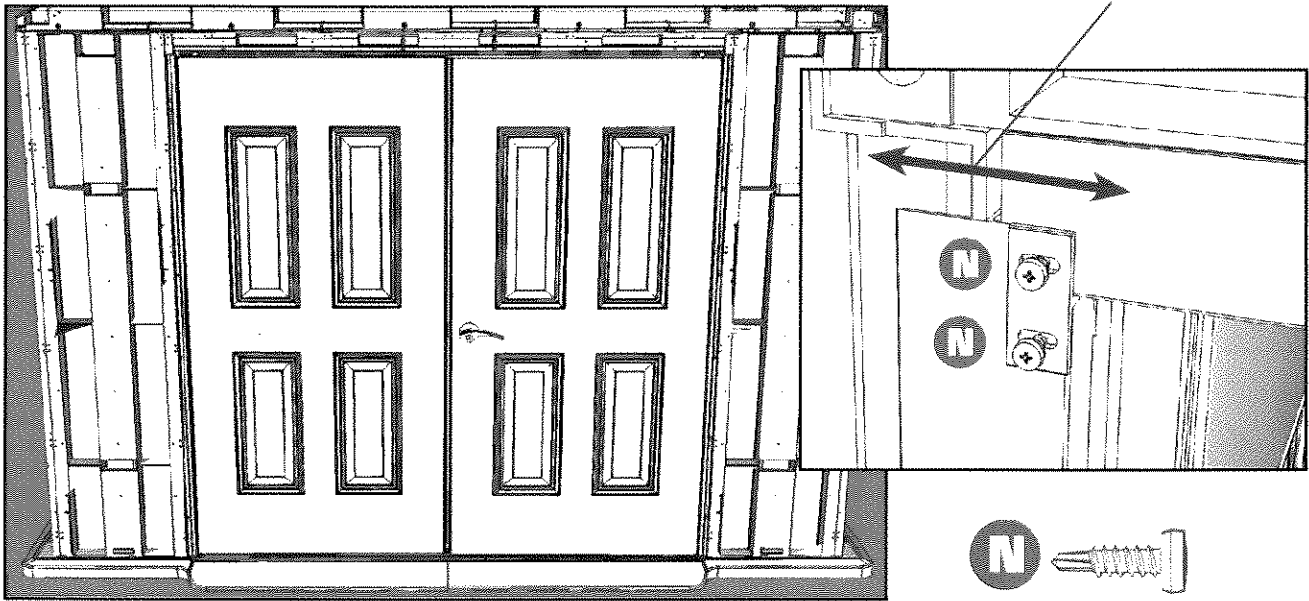

(4)- #10-1/2" Self Tapping Pan Head

41

Storm Chain

Position Storm Chain Bracket over pre-marked pilot holes both doors.

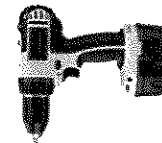
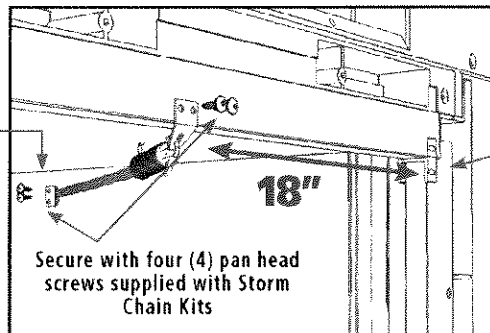

To attach Storm Chain to Door Header- Measure 18" from door frame, mark holes and predrill with 1/8" drill bit then attach with four (4) Pan Head Screws supplied with Storm Chain Kit.

42 Left Side Door Bolts Upper & Lower

Position Upper and Lower Door Bolts over pre-marked holes in Left door

Secure with Four (4) each #10-1" Pan Head Screws

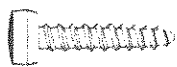

4 ea.
#10-1" Pan Head

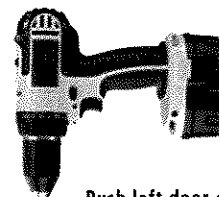
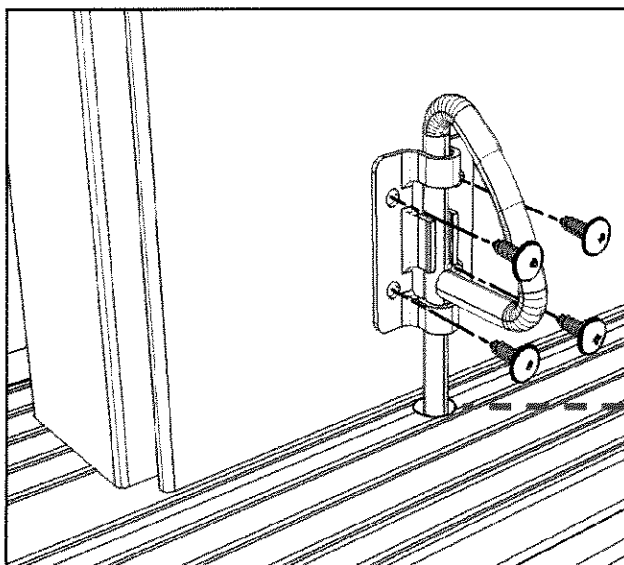

Push left door closed and hold tight with door bolts, (upper and lower) in position, push bolt against surface and mark. Drill 3/8" access hole for bolt.

43 Door Handle

Handle Hardware
(see instructions inside box)



Hint

Homestyles Handyman Hint:

Some minor adjustment to doors may be necessary for proper alignment. If needed, looser screws in step 40. Make adjustments, and re-tighten screws.

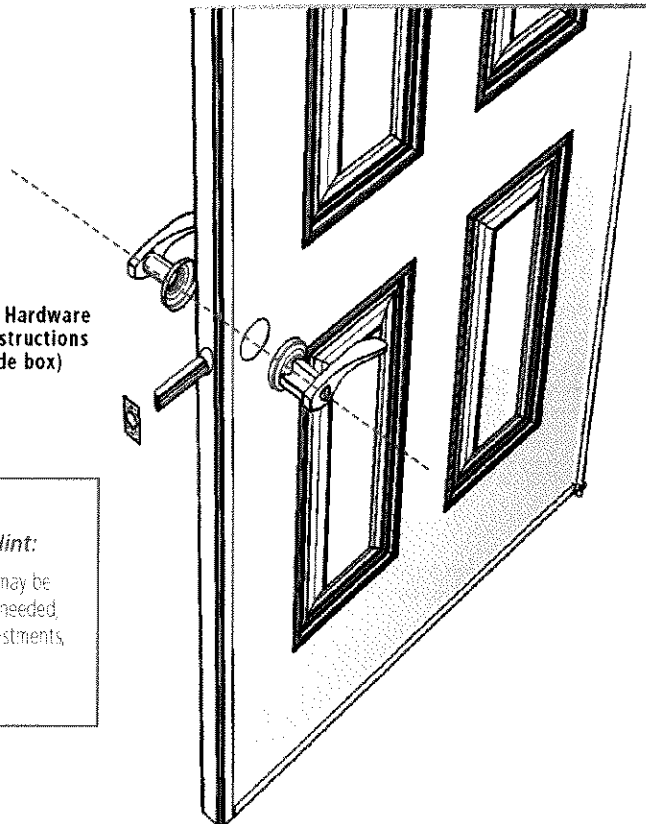

Stage 6 Siding

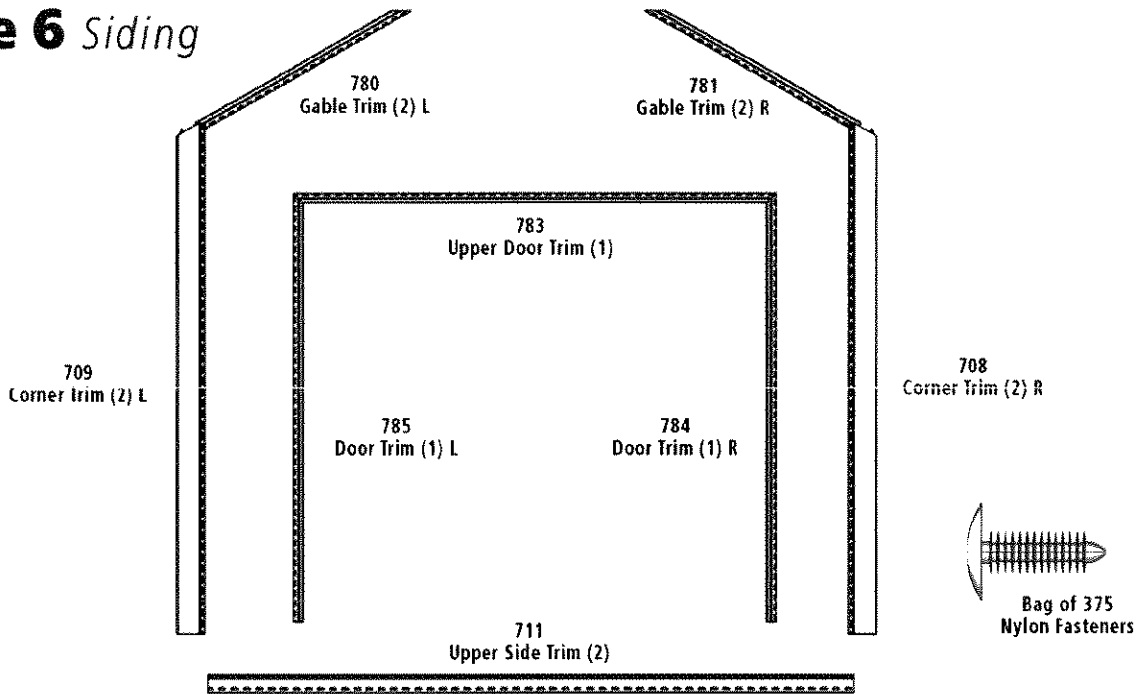

Siding Panels

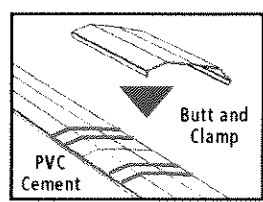
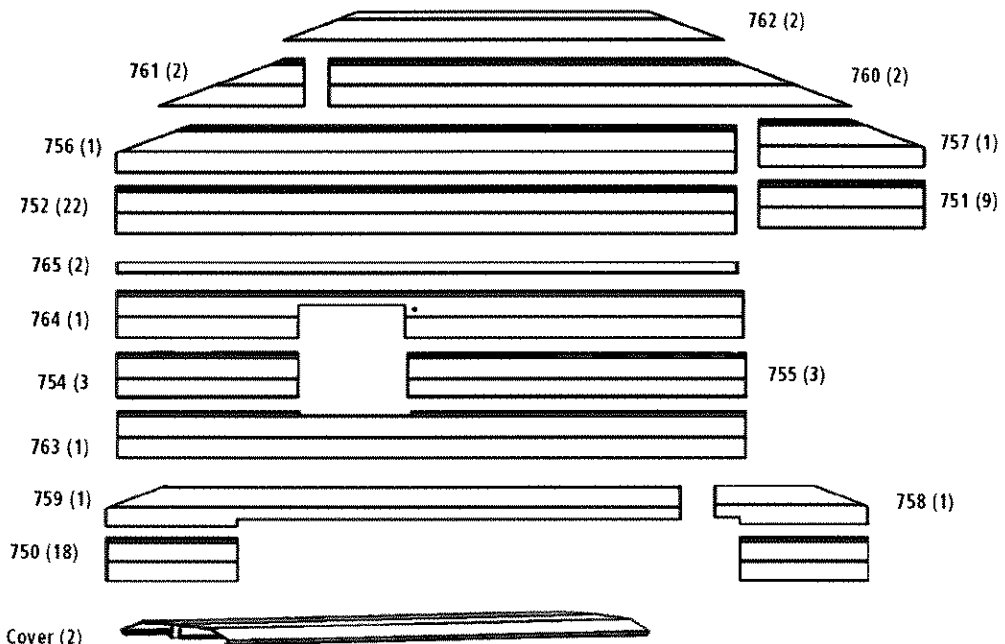

Homestyles Handyman Hint:
 Pre-assemble Ridge Cap Splice and Ridge Cover Approx. 24 hrs Prior to snapping into place



44

**Position J-Channel Trim
Front - Sides - Rear**

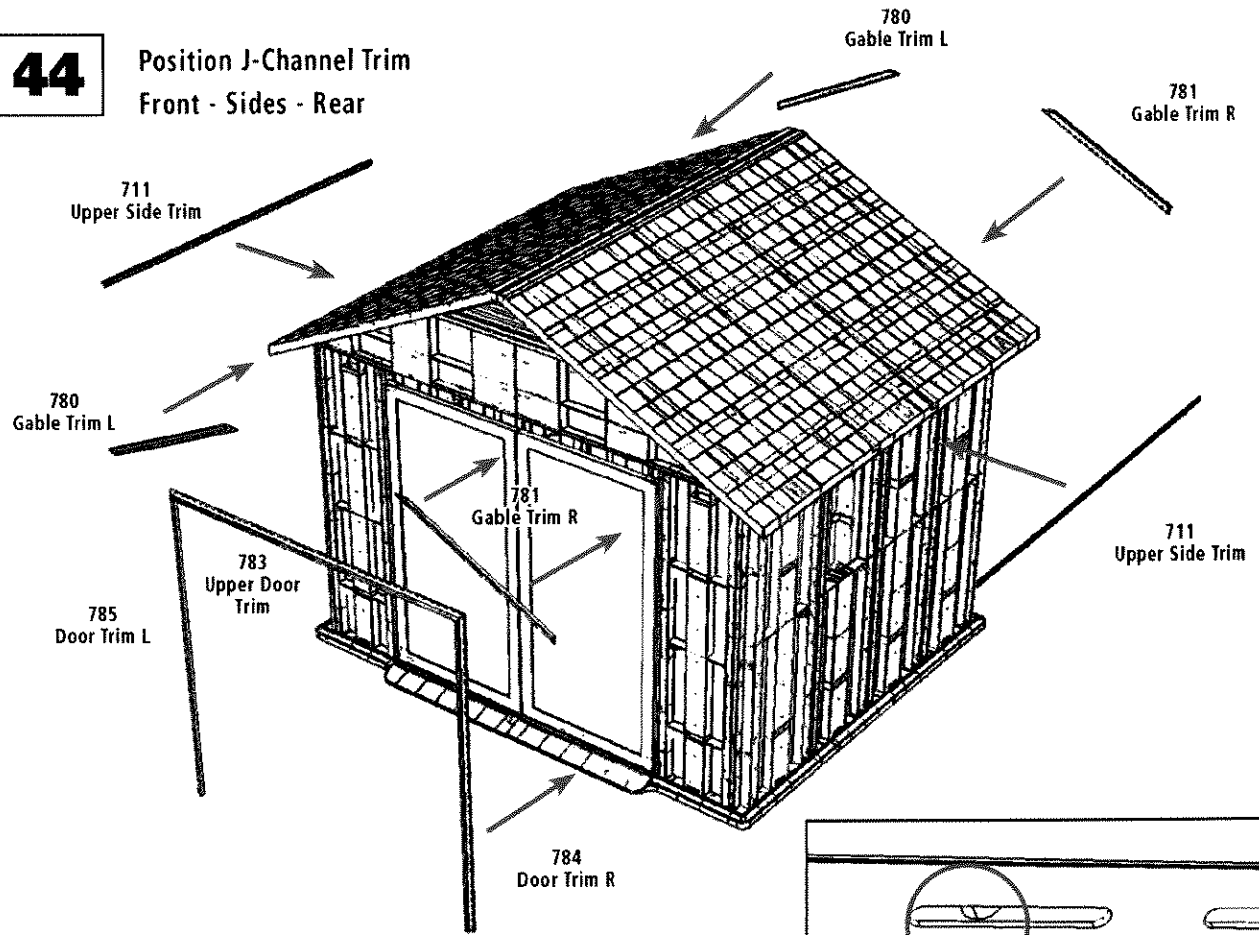

45

Secure with Nylon Fasteners every 12" - 16"

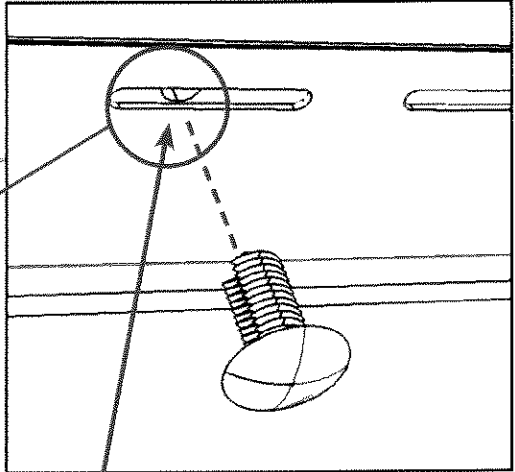
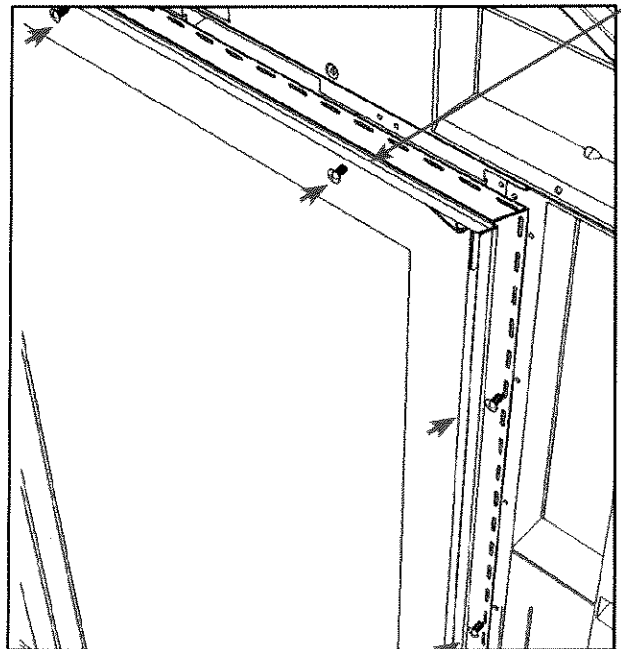

Hint

Homestyles Handyman Hint:
 Locate and pre-pierce fastener holes with small Phillips head screwdriver or 1/4" drill bit prior to inserting Nylon Fastener

46 Siding Starter Row

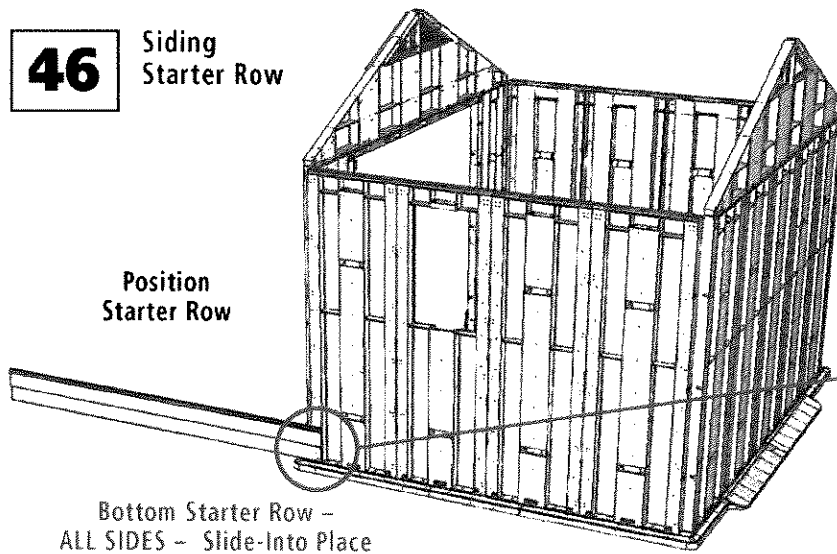

Starter Row Attaches to Guides at Base

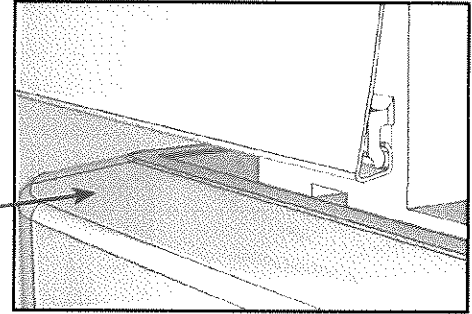

47 Secure with Nylon Fasteners
Approximately every 12"-16"

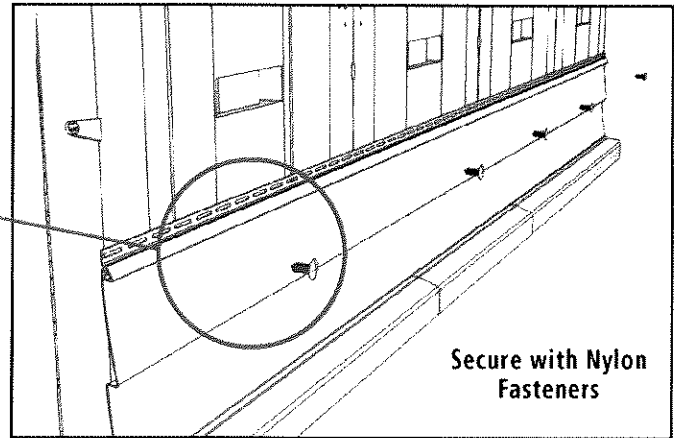
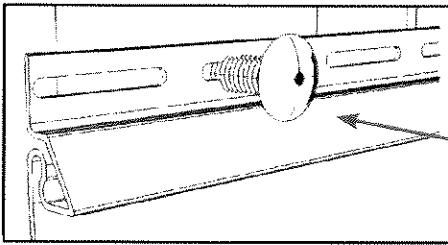

48 Position Corner Trim
Approximately every 12"-16"

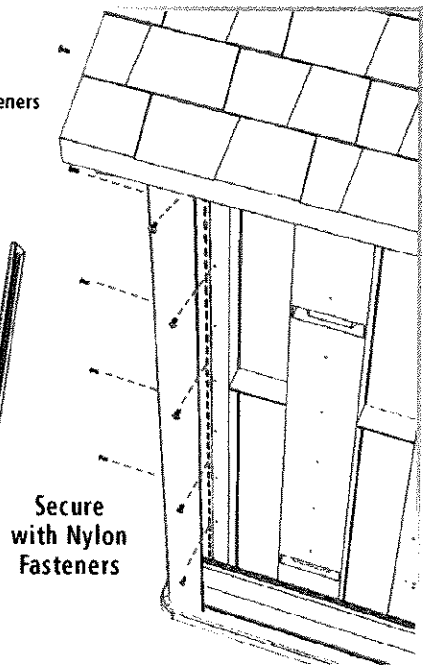
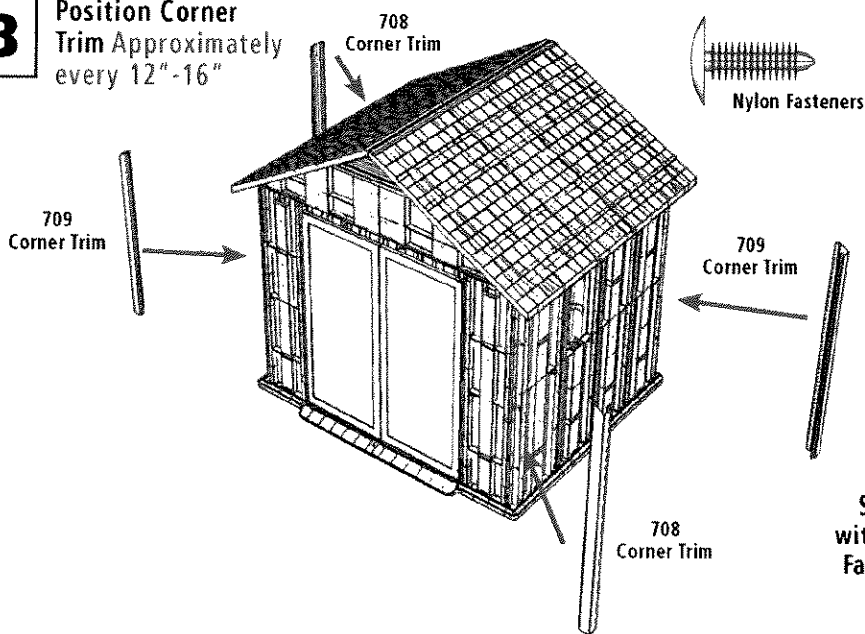

49

Siding Sequence



Homestyles Handyman Hint:
Tighten vent screws, after last siding panels are in place (762 Front and Rear)

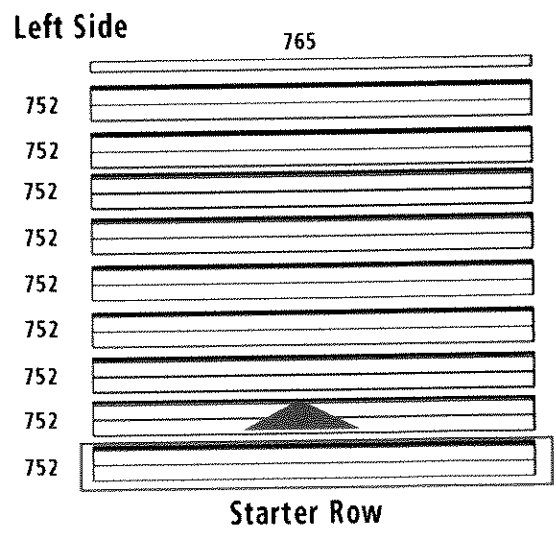
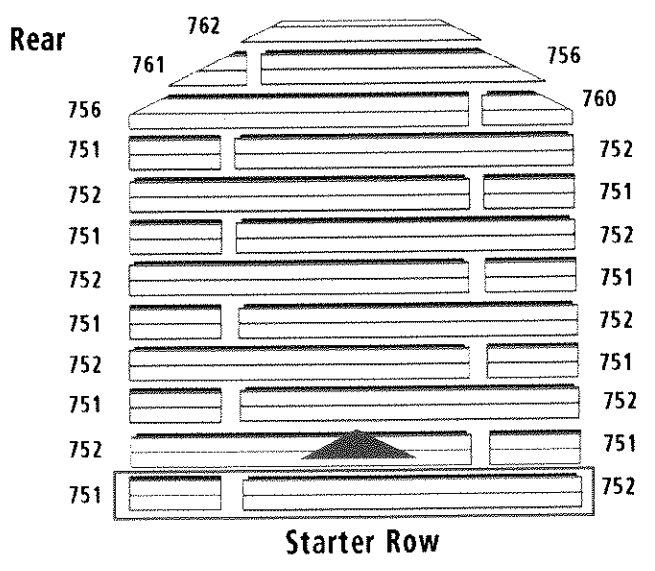
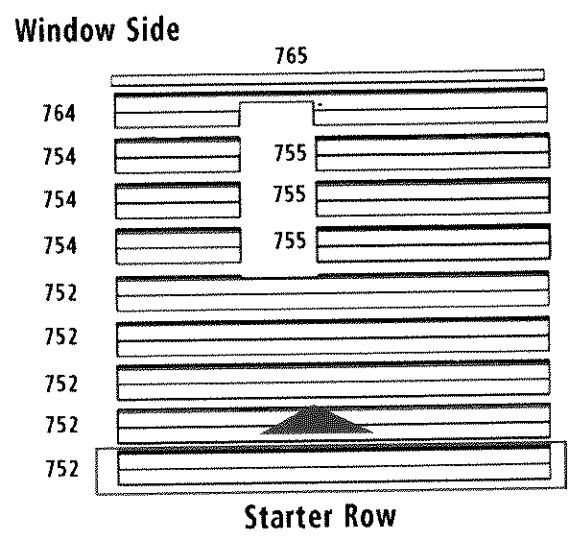
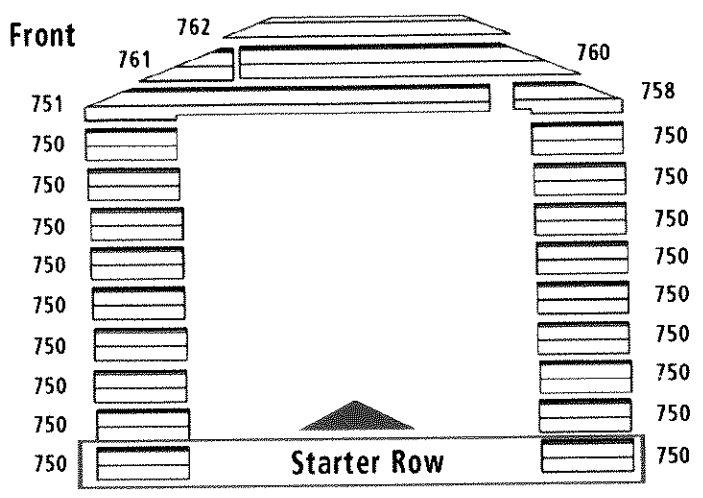
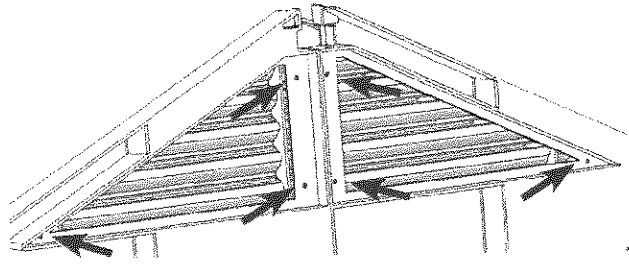

50

Roof Ridge Cover Sequence

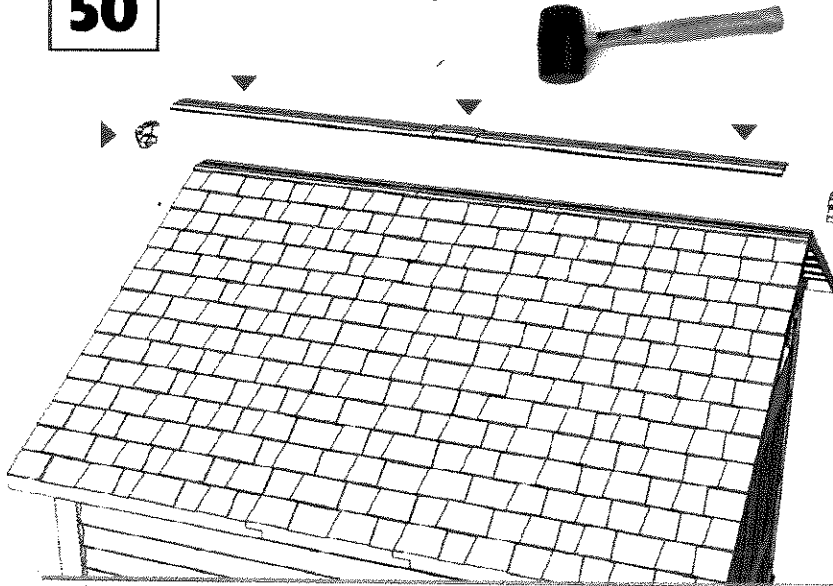

Align Ridge Covers over Center Beam

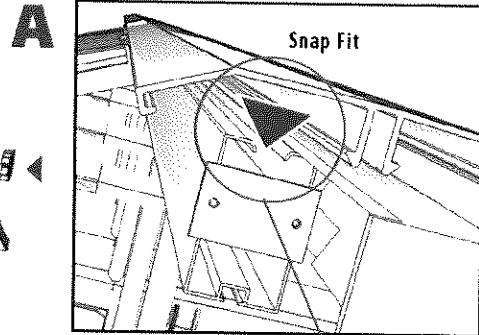

Press to Snap into Place

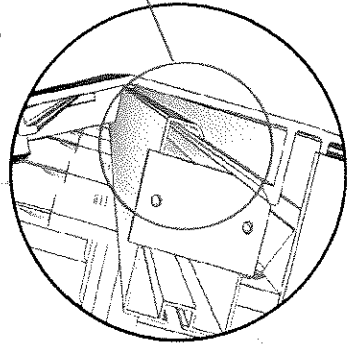

B

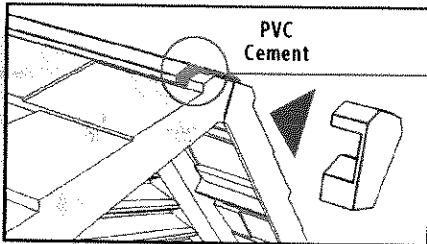

PVC Cement

Apply PVC Cement over Ridge Cover Position Ridge Cap. Hold in position until Cement is set.

PVC Cement



Stage 7 Securing Shed To Base

It is highly recommended to attach your shed to your base (wood or concrete) for added wind resistance.

Use holes provided in floor for attachment. (fasteners not included).

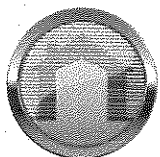
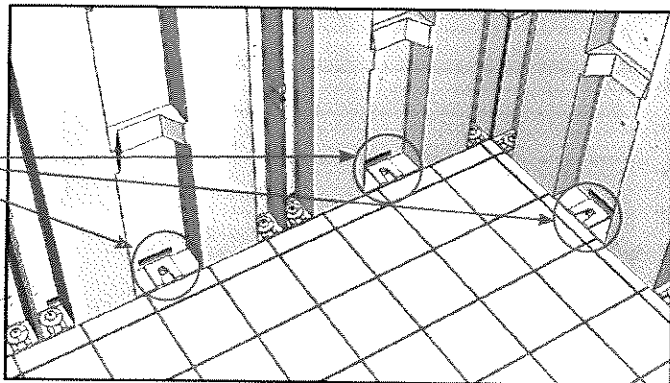

Style and durability made easy
Homestyles
outdoor storage