

DISPLAY THIS CARD ON PRINCIPAL FRONTAGE OF WORK
CITY OF PORTLAND PERMIT ISSUED

Please Read
 Application And
 Notes, if Any,
 Attached

BUILDING PERMIT

AUG 25
 Permit Number: 091169

This is to certify that KILMARTIN SIDNEY P & DAVID GRAHAM of the City of Portland
 has permission to New 1 1/2 story w/ full dormer, 3 bedroom, 1 bath, 1.5 car Family Home - No Garage
 AT S Eastman Avenue CE 332-G001001

provided that the person or persons, firm or corporation accepting this permit shall comply with all of the provisions of the Statutes of Maine and of the Ordinances of the City of Portland regulating the construction, maintenance and use of buildings and structures, and of the application on file in this department.

Apply to Public Works for street line and grade if nature of work requires such information.

Notification of inspection must be given and written permission procured before this building or part thereof is lathed or otherwise finished-in. 24 HOURS NOTICE IS REQUIRED.

A certificate of occupancy must be procured by owner before this building or part thereof is occupied.

OTHER REQUIRED APPROVALS

Fire Dept. _____

Health Dept. _____

Appeal Board _____

Other _____

Department Name

Director - Building & Inspection Services

PENALTY FOR REMOVING THIS CARD

City of Portland, Maine - Building or Use Permit Application

389 Congress Street, 04101 Tel: (207) 874-8783, Fax: (207) 874-8716

Permit No: 09-1169	Issue Date:	CBL: 332 G001001
-----------------------	-------------	---------------------

Location of Construction: 5 Eastman Avenue	Owner Name: KILMARTIN SIDNEY P & DEBO	Owner Address: 174 BARNSTABLE RD	Phone:
Business Name:	Contractor Name: TBD	Contractor Address:	Phone:
Lessor/Buyer's Name:	Phone:	Permit Type: Single Family	Zone: R-3

Past Use: Vacant Land - lot split from 22 Bailey	Proposed Use: Single Family Home - New 1 1/2 story w/ full basement, 3 bedroom, 1 1/2 bath Single Family Home - No Garage	Permit Fee: \$895.00	Cost of Work: \$80,000.00	CEO District: 5
-----------------------------------------------------	------------------------------------------------------------------------------------------------------------------------------	-------------------------	------------------------------	--------------------

Proposed Project Description: New 1 1/2 story w/ full basement, 3 bedroom, 1 1/2 bath Single Family Home - No Garage	FIRE DEPT: <input type="checkbox"/> Approved <input checked="" type="checkbox"/> Refused Signature: <i>[Signature]</i>	INSPECTION: Use Group: R-3 Type: SB Signature: <i>[Signature]</i>
-------------------------------------------------------------------------------------------------------------------------	---------------------------------------------------------------------------------------------------------------------------	-------------------------------------------------------------------------

Permit Taken By: L. Johnson	Date Applied For: 10/20/2009	Zoning Approval
--------------------------------	---------------------------------	------------------------

1. This permit application does not preclude the Applicant(s) from meeting applicable State and Federal Rules. 2. Building permits do not include plumbing, septic or electrical work. 3. Building permits are void if work is not started within six (6) months of the date of issuance. False information may invalidate a building permit and stop all work.	Special Zone or Reviews <input type="checkbox"/> Shoredland N/A <input type="checkbox"/> Wetland N/A <input type="checkbox"/> Flood Zone parcel to zone X <input type="checkbox"/> Subdivision <input checked="" type="checkbox"/> Site Plan 2009 - D075 Maj <input type="checkbox"/> Minor <input type="checkbox"/> MM <input checked="" type="checkbox"/> OK w/ conditions Date 8/25/10 ABM	Zoning Appeal <input type="checkbox"/> Variance <input type="checkbox"/> Miscellaneous <input type="checkbox"/> Conditional Use <input type="checkbox"/> Interpretation <input type="checkbox"/> Approved <input type="checkbox"/> Denied Date:	Historic Preservation <input checked="" type="checkbox"/> Not in District or Landmark <input type="checkbox"/> Does Not Require Review <input type="checkbox"/> Requires Review <input type="checkbox"/> Approved <input type="checkbox"/> Approved w/Conditions <input type="checkbox"/> Denied Date: ABM
-----------------------------------------------------------------------------------------------------------------------------------------------------------------------------------------------------------------------------------------------------------------------------------------------------------------------------------------------------------------------	--------------------------------------------------------------------------------------------------------------------------------------------------------------------------------------------------------------------------------------------------------------------------------------------------------------------------------------------------------------------------------------------------------------------------	----------------------------------------------------------------------------------------------------------------------------------------------------------------------------------------------------------------------------------------------------------------------	---------------------------------------------------------------------------------------------------------------------------------------------------------------------------------------------------------------------------------------------------------------------------------------------------------------------------------

PERMIT ISSUED
AUG 25

City of Portland

CERTIFICATION

I hereby certify that I am the owner of record of the named property, or that the proposed work is authorized by the owner of record and that I have been authorized by the owner to make this application as his authorized agent and I agree to conform to all applicable laws of this jurisdiction. In addition, if a permit for work described in the application is issued, I certify that the code official's authorized representative shall have the authority to enter all areas covered by such permit at any reasonable hour to enforce the provision of the code(s) applicable to such permit.

SIGNATURE OF APPLICANT ADDRESS DATE PHONE

RESPONSIBLE PERMITS

BUILDING PERMIT INSPECTION PROCEDURES

Please call 874-8703 or 874-8693 (ONLY)

or email: buildinginspections@portlandmaine.gov

With the issuance of this permit, the owner, builder or their designee is required to provide adequate notice to the City of Portland Inspection Services for the following inspections. Appointments must be requested 48 to 72 hours in advance of the required inspection. The inspection date will need to be confirmed by this office.

- Please read the conditions of approval that is attached to this permit!! Contact this office if you have any questions.
- Permits expire in 6 months, if the project is not started or ceases for 6 months.
- If the inspection requirements are not followed as stated below additional fees may be incurred due to the issuance of a "Stop Work Order" and subsequent release to continue with construction.

Footing/Building Location Inspection: Prior to pouring concrete or setting precast piers

Foundation Inspection: Prior to placing ANY backfill for below grade occupiable space

Framing/Rough Plumbing/Electrical: Prior to Any Insulating or drywalling

Final/Certificate of Occupancy: Prior to any occupancy of the structure or use.
NOTE: There is a \$75.00 fee per inspection at this point.

The project cannot move to the next phase prior to the required inspection and approval to continue, REGARDLESS OF THE NOTICE OR CIRCUMSTANCES.

IF THE PERMIT REQUIRES A CERTIFICATE OF OCCUPANCY, IT MUST BE PAID FOR AND ISSUED TO THE OWNER OR DESIGNEE BEFORE THE SPACE MAY BE OCCUPIED.

PERMIT ISSUED

AUG 25

City of Portland

City of Portland, Maine - Building or Use Permit

389 Congress Street, 04101 Tel: (207) 874-8703, Fax: (207) 874-8716

Permit No: 03-1169	Date Applied For: 10/20/2009	CBL: 332 G001001
-----------------------	---------------------------------	---------------------

Location of Construction: 5 Eastman Avenue	Owner Name: KILMARTIN SIDNEY P & DEBO	Owner Address: 174 BARNSTABLE RD	Phone:
Business Name:	Contractor Name: TBD	Contractor Address:	Phone:
Lessee/Buyer's Name:	Phone:	Permit Type: Single Family	

Proposed Use: Single Family Home -New 1 1/2 story w/ full dormer, 3 bedroom, 1 1/2 bath Single Family Home - No Garage	Proposed Project Description: New 1 1/2 story w/ full dormer, 3 bedroom, 1 1/2 bath Single Family Home - No Garage
---------------------------------------------------------------------------------------------------------------------------	-----------------------------------------------------------------------------------------------------------------------

Dept: Zoning	Status: Approved with Conditions	Reviewer: Ann MacIsaac	Approval Date: 08/25/2010
Note:	PERMIT ISSUED Ok to Issue: ✓		
<p>1) This permit is being issued with the understanding there will not be a deck built on the rear.</p> <p>2) This property shall remain a single family dwelling. Any change of use shall require a separate permit application for review and approval.</p> <p>3) This permit is being approved on the basis of plans submitted. Any deviations shall require a separate application before starting that work.</p>			

Dept: Building	Status: Approved with Conditions	Reviewer: Tammy Munson	Approval Date: 08/27/2010
Note:	PERMIT ISSUED Ok to Issue: ✓		
<p>1) Hardwired interconnected battery backup smoke detectors shall be installed in all bedrooms, protecting the bedrooms, and on every level.</p> <p>2) The design load spec sheets for any engineered beam(s) / Trusses must be submitted to this office.</p> <p>3) Separate permits are required for any electrical, plumbing, sprinkler, fire alarm HVAC systems, heating appliances, including pellet/wood stoves, commercial hood exhaust systems and fuel tanks. Separate plans may need to be submitted for approval as a part of this process.</p> <p>4) Those building a new single family dwelling shall install a CO detector in each area within or giving access to bedrooms. That detection must be powered by the electrical service in the building and battery.</p> <p>5) There shall be a 22" x 30" attic scuttle accessing roof areas higher than 30".</p> <p>6) The U-values of the windows must be 0.35 or lower.</p> <p>7) The first and second floor joists must overlap each other at the meeting point by a minimum of 3" per section S02.6.1 of the IRC. They cannot meet end to end as drawn in the plans.</p>			

Dept: DRC	Status: Approved with Conditions	Reviewer: Philip DiPietro	Approval Date: 01/08/2010
Note:	PERMIT ISSUED Ok to Issue: ✓		
<p>1) The foundation drain outlet shall be located a minimum of 10 feet from the property lines within the bounds of the applicant's property.</p> <p>2) Erosion and Sedimentation control shall be established and inspected by the Development Review Coordinator prior to soil disturbance, and shall be done in accordance with Best Management Practices, Maine Department of Environmental Protection Technical and Design Standards and Guidelines. All Erosion and Sedimentation control measures must be inspected and maintained daily.</p> <p>3) The Development Review Coordinator reserves the right to require additional lot grading or other drainage improvements as necessary due to field conditions.</p> <p>4) A street opening permit(s) is required for your site. Please contact Carol Merritt at 874-8300, ext. 8822. (Only excavators licensed by the City of Portland are eligible.)</p>			

Location of Construction: 5 Eastman Avenue	Owner Name: KILMARTIN SIDNEY P & DEBO	Owner Address: 174 BARNSTABLE RD	Phone:
Business Name:	Contractor Name: TBD	Contractor Address:	Phone:
Lessee/Buyer's Name:	Phone:	Permit Type: Single Family	

- 5) A sewer permit is required for your project. Please contact Carol Merritt at 874-8300, ext. 8822. The Wastewater and Drainage section of Public Services must be notified five (5) working days prior to sewer connection to schedule an inspector for your site.
- 6) All damage to sidewalk, curb, street, or public utilities shall be repaired to City of Portland standards prior to issuance of a certificate of occupancy.
- 7) The Development Review Coordinator (874-8632) must be notified five (5) working days prior to date required for final site inspection. Please make allowances for completion of site plan requirements determined to be incomplete or defective during the inspection. This is essential as all site plan requirements must be completed and approved by the Development Review Coordinator prior to issuance of a Certificate of Occupancy. Please schedule any property closing with these requirements in mind.
- 8) Two (2) City of Portland approved species and size trees must be planted on your street frontage prior to issuance of a Certificate of Occupancy.
- 9) All Site work (final grading, landscaping, loam and seed) must be completed prior to issuance of a certificate of occupancy.

Comments:

3/22/2010-amachado: Tammy has completed her building review. Left a voicemail for Debbie Kilmartin that the review is complete but the permit can't be issued until there is a demo permit for the garage and it is demolished. Permit is in my hold basket.

5/4/2010-amachado: Permit #10-0439 applied for to demolish the garage at 22 Bailey Ave.

8/25/2010-amachado: Spoke to Nick. Garage has been demolished (#10-0439).

10/27/2009-amachado: Spoke to Deborah Kilmartin. Can't issue the building permit until the garage is demolished or relocated. Will need a permit for that. The deck on the rear of the house (8'x10' on site plan and 12' x 10' on building plans) does not meet the rear setback. It is 25' to the rear of the house. The house has a full dormer on the rear; this makes it a two story house. It needs to meet 14' side setback but it is only 8' at the front corner. If stacked, the parking needs to extend 38' beyond the front setback. The existing parking scaled at 36' and 33'.

11/9/2009-amachado: Met with potential builder/buyer of property. Explained the difference between a 1 1/2 story & a two story. Went over other issues with siteplan. He will apply to demolish the garage or relocate it ASAP.

12/1/2009-amachado: Deborah Kilmartin brought in revised siteplan that meets the zoning requirements. She amended the building plans. I told her that she needs to give a revised siteplan to Phil DiPierro.

12/1/2009-amachado: Permit can't be issued until the garage is demolished or moved.

12/1/2009-amachado: Revised siteplan does not meet lot width. Tried to leave message for Deb Kilmartin but her voice mailbox was full.

12/2/2009-amachado: Left vcm for Deb Kilmartin. Does not meet lot width.

1/6/2010-amachado: Received revised siteplan & building plans.

1/7/2010-amachado: Left voicemail for Deb Kilmartin. Deck shown on building plans can't be built (doesn't meet setbacks). Bulkhead needs to be shown on the siteplan.

1/11/2010-amachado: Received email from Deb Kilmartin re: deck and bulkhead.

1/11/2010-amachado: Moved permit forward in review process to plan reviewer but can't sign off until owner applies for demo permit and the garage is demolished.

PERMIT ISSUED

AUG 25

City of Portland



General Building Permit Application

If you or the property owner owes real estate or personal property taxes or user charges on any property within the City, payment arrangements must be made before permits of any kind are accepted.

Location/Address of Construction: <u>EASTMAN AVE (Part of 22 Bailey Ave)</u>	
Total Square Footage of Proposed Structure/Area <u>884 sq ft</u>	Square Footage of Lot <u>7579 sq ft (Part of 22 Bailey Ave)</u>
Tax Assessor's Chart, Block & Lot Chart# <u>332</u> Block# <u>G</u> Lot# <u>001</u> <u>A PORTION OF 002 & 003</u>	Applicant *must be owner, Lessee or Buyer* Name <u>DEBORAH KILMARTIN</u> Address <u>174 Barnstable Rd</u> City, State & Zip <u>Small Portland 04106</u>
Telephone: <u>807-7370</u>	
Lessee/DBA (If Applicable) <u>N/A</u>	Owner (if different from Applicant) Name Address City, State & Zip
Cost Of Work: <u>\$80,000</u>	C of O Fee: <u>75</u>
Total Fee: <u>\$1,195</u>	
Current legal use (i.e. single family) <u>VACANT LOT</u> If vacant, what was the previous use? <u>GARAGE</u> Proposed Specific use: <u>SINGLE FAMILY HOME</u> Is property part of a subdivision? <u>No</u> If yes, please name <u>2 story - 5111 Dalton St</u> Project description: <u>CONSTRUCTION OF A 1 1/2 STORY SINGLE FAMILY DWELLING. NO GARAGE, PARKING OF TWO CARS. 3bed & 1.5 Baths.</u>	
Contractor's name: <u>TBD</u> Address: City, State & Zip Telephone:	Who should we contact when the permit is ready: <u>Deb Kilmartin</u> Telephone: <u>807-7370</u> Mailing address: <u>174 Barnstable S.P. 04106</u>

Please submit all of the information outlined on the applicable Checklist. Failure to do so will result in the automatic denial of your permit.

In order to be sure the City fully understands the full scope of the project, the Planning and Development Department may request additional information prior to the issuance of a permit. For further information or to download copies of this form and other applications visit the Inspections Division on-line at www.portlandmaine.gov, or stop by the Inspections Division office, room 315 City Hall or call 874-8703.

I hereby certify that I am the Owner of record of the named property, or that the owner of record authorizes the proposed work and that I have been authorized by the owner to make this application as his/her authorized agent. I agree to conform to all applicable laws of this jurisdiction. In addition, if a permit for work described in this application is issued, I certify that the Code Official authorized representative shall have the authority to enter all areas covered by this permit at any reasonable hour to enforce the provisions of the codes applicable to this permit.

Signature: [Signature] Date: 10/20

This is not a permit; you may not commence ANY work until the permit is issued.

RECEIVED
OCT 20 2009
Dept. of Building Inspections
City of Portland Maine

*revised site plan received 1/6/10

Applicant: Deborah Kilmarck

Date: January 7, 2010

Address: 5 Eushen Ave.

C-B-L: 332-6-001

permit # 09-1169

CHECK-LIST AGAINST ZONING ORDINANCE

Date - new

Zone Location - R-3

Interior or corner lot

Proposed Use/Work - build new single family home 24'x32' one & half story house

Waste Disposal - city/public

Lot Street Frontage - 50' min - 50' + 120' = 170' (OK)

Front Yard - 25' min. - 45' scaled from ^(right) corner of base

Rear Yard - 25' min - 26' to building - bulkhead 6' out - 31' + 6' (OK under section 14-425)

Side Yard - 1 1/2 stories - 5' 10' scaled on right - 7.25 to side entry but 5' out = 32.5' (OK under section 14-425)
20' scaled on left (OK)
Side yard bulkhead 20'

Projections - Side stairs 5'x6.5'; front stairs 6'x4'; bulkhead 5'4" x 6'

Width of Lot - 65' min - scale @ 65' (OK)

Height - 35' max - 20' @ dormer

Lot Area - 6500 sq ft - 7579 sq ft (OK)

Lot Coverage/Impervious Surface - 35% = 2275 sq ft (OK)

32x24 = 768 sq ft
5.33x6 = 31.98
5x6.5 = 32.5
6x4 = 24
856.48

Area per Family - 6500 sq ft (OK)

Off-street Parking - 2 spaces required (OK) 20' x 19'

Loading Days - N/A

Site Plan - minor minor 2009-0075

Shoreland Zoning/Streams Protection - N/A

Flood Plains - panel 6 - Zone X

* existing garage must be removed ~~before~~ before permit issued

Zoning for ~~existing~~ ^{existing} house lot. **OK**

Applicant: Deborah K. Martin

Date:

Address: 22 Bailey St.

C-B-L: OIA 332-6-001
permit # 05-1169

CHECK-LIST AGAINST ZONING ORDINANCE

Date -

Zone Location -

Interior or corner lot -

Proposed Use/Work -

Sewage Disposal -

Lot Street Frontage - 50' - 174.43' ⁵ in.

Front Yard - N/A - existing

Rear Yard - N/A - existing

Side Yard - 21' ^{14'} min. - 14' min. - 14' min. - ^{left side only} scale & just 14' but ok as because
could borrow a foot from either side

Projections -

Width of Lot - 65' min. - 97' scaled & about park

Height -

Lot Area - 6500 ^{sq} ft - 10,143.7 ^{sq} ft ^{OK}

Lot Coverage/Impervious Surface - 35% = 3557.30

$$34 \times 21 = 814$$

$$8 \times 15 = 120$$

$$4 \times 7 = 28$$

$$13 \times 6 = 78$$

$$\hline 1110 \text{ ft}^2 \text{ (OK)}$$

Area per Family -

Off-street Parking - 4 parking spaces - 20 x 8 ft **OK**

Loading Bays -

Site Plan - 2

Shoreland Zoning/Stream Protection -

Flood Plains -

This page contains a detailed description of the Parcel ID you selected. Press the **New Search** button at the bottom of the screen to submit a new query.

Current Owner Information

Card Number 1 of 1
Parcel ID 332 G001001
Location 22 BAILEY AVE
Land Use TWO FAMILY

Owner Address KILMARTIN SIDNEY P & DEBORAH A JTS
 174 HARBESTABLE RD
 SOUTH PORTLAND ME 04106

Book/Page 14938/133
Legal 332-G-1 TO 6
 BAILEY AVE 22-38
 EASTMAN AVE 1-7 TARRILL AVE 3-9
 1745 SF

Current Assessed Valuation

Land	Building	Total
\$73,100	\$180,000	\$252,100

Property Information

Year Built 1924	Style Colonial	Story Height 2	Sq. Ft. 2122	Total Acres 0.407	
Bedrooms 5	Full Baths 2	Half Baths	Total Rooms 10	Attic Full Finish	Basement Full

Outbuildings

Type GARAGE - WD/CB	Quantity 1	Year Built 1960	Size 21X22	Grade C	Condition A
-------------------------------	----------------------	---------------------------	----------------------	-------------------	-----------------------

Sales Information

Date 07/29/1999	Type LAND + BLDING	Price \$120,000	Book/Page 14938-133
---------------------------	------------------------------	---------------------------	-------------------------------

Picture and Sketch

[Picture](#) [Sketch](#) [Tax Map](#)

[Click here](#) to view Tax Roll Information.

Any information concerning tax payments should be directed to the Treasury office at 874-8490 or e-mailed.





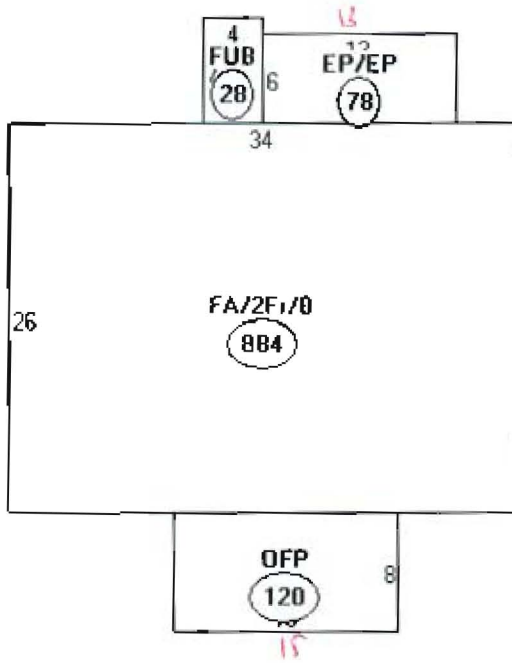

Descriptor/Area

- A: FA/2F1/0
884 sqft
- B: FUB
28 sqft
- C: EP/EP
78 sqft
- D: OFF
120 sqft



PORTLAND MAINE

Strengthening a Remarkable City. Building a Community for Life • www.portlandmaine.gov

*Penny St. Louis Littell - Director of Planning and Urban Development
Marge Schmuckal, Zoning Administrator*

September 9, 2009

Deborah Kilmartin
174 Barnstable Road
South Portland, ME 04106

RE: 22 Bailey Avenue – 332-G-1 to 6 – R-3 Residential Zone – Proposed Lot Split

Dear Ms. Kilmartin,

I am in receipt of your request to determine whether a proposed lot split results in a "buildable lot". I am relying upon a submitted survey prepared by Robert T. Greenlaw of Ocean Park Land Surveying, LLC, date of survey 07/22/2004, Job Number 2009006. I would first of all call attention that even though this survey is signed and sealed, apparently it is inaccurate. This survey is not showing an existing garage that shall be demolished or removed prior to the split of the land. There is no note on the plan stating that it was present at the time of the survey. I am hoping that I can rely upon this plan for all other specifics that I am using for this determination. Separate permits from Inspection Services are required for both a demolition or the moving of this garage to determine compliance with City Ordinances.

I have reviewed both the original lot with an existing two family built around 1924 and the newly proposed vacant lot that abuts both Eastman Avenue and Tarbell Street. Both lots are meeting the underlying R-3 Zone with the condition that the still existing garage is removed prior to the lot split. It is a requirement that the garage be removed prior to the lot split so that a zoning violation will not exist. If the garage is to be moved, such an action will need review to insure compliance with Zoning.

You have also included an order by the Courts signed by E. Mary Kelly, Family Law Magistrate for the Maine District Court dated May 28, 2009. This court action exempts this land split from review from State and City Subdivision laws under 30-A MRSA 4.D-3. Although this lot split is not subject to review under State and City Subdivision laws, the new lot is subject to review under other City Site Plan Review requirements along with building permit requirements. This letter of determination is not to be construed as permission to build. As stated above, separate reviews and permits are required prior to the start of work. All other City Ordinances must be met as part of the review process.

I again mention that if there are any more revelations of errors or omissions on the submitted site plan, it may render this determination void. This letter should be submitted with any future building permit submittal on the newly proposed lot.

If you have any questions regarding this letter, please do not hesitate to contact me at 874-8695.

Very truly yours,

Marge Schmuckal
Zoning Administrator

Cc: file

09-1169

5 Eastman Ave

ONE AND TWO FAMILY	PLAN REVIEW	CHECKLIST
Soil type/Presumptive Load Value (Table R401.4.1)		
Component	Submitted Plan	Findings/Revisions/Dates
STRUCTURAL		
Footing Dimensions/Depth (Table R403.1 & R403.1(1), (Section R403.1 & R403.1.4.1)	10" x 16" Footing	
Foundation Drainage, Fabric, Damp proofing (Section R405 & R406)	see note 14 + 15	
Ventilation/Access (Section R408.1 & R408.3) Crawls Space ONLY	N/A	
Anchor Bolts/Straps, spacing (Section R403.1.6)	9/8" x 12" - OK	
Lally Column Type (Section R407)		
Girder & Header Spans (Table R 502.5(2))	3-2x10's - max 7'-7" span - OK	
Built-Up Wood Center Girder Dimension/Type	d	
Sill/Band Joist Type & Dimensions	2x6 PT Plate	
First Floor Joist Species Dimensions and Spacing (Table R502.3.1(1) & Table R502.3.1(2))	2x10's - 12" OC 2x10's - 16" OC	502.6.1 - overlap 3" min do not overlap @ joint
Second Floor Joist Species Dimensions and Spacing (Table R502.3.1(1) & Table R502.3.1(2))	" "	" "
Attic or additional Floor Joist Species Dimensions and Spacing (Table R802.4(1) and	2x6 collar ties	

09-1169

R802.4(2))		
Pitch, Span, Spacing & Dimension (Table R802.5.1(1) - R 802.5.1(8)) Roof Rafter; Framing & Connections (Section R802.3 & R802.3.1)	2x8 Rear 2x10 front } OK	
Sheathing; Floor, Wall and roof (Table R503.2.1.1(1))	5/8" Roof, 1/2" walls, 3/4" floors	
Fastener Schedule (Table R602.3(1) & (2))	Per IRC	
Private Garage (Section R309) Living Space ? (Above or beside)	N/A	
Fire separation (Section R309.2)		
Opening Protection (Section R309.1)	N/A	
Emergency Escape and Rescue Openings (Section R310)	OK shows egress	
Roof Covering (Chapter 9)	asphalt	
Safety Glazing (Section R308)	N/A	
3) Attic Access (Section R807)	if over 30" provide 22" x 30" access	
Chimney Clearances/Fire Blocking (Chap. 10)	Shows 2" w/draft stop	
Header Schedule (Section 502.5(1) & (2))	see schedule	
Energy Efficiency (N1101.2.1) R-Factors of Walls, Floors, Ceilings, Building Envelope, U-	R-38 Roof R-19 walls	

U - value under 0.35
Floor - R.19

09-1169

Factor Fenestration	Boiler	
Type of Heating System	Boiler ✓	
Means of Egress (Sec R311 & R312)		
Basement 1		
Number of Stairways 3		
Interior 1		
Exterior 2		
Treads and Risers (Section R311.5.3) 10", 7 3/4"		
Width (Section R311.5.1) 3' finished		
Headroom (Section R311.5.2) - 6' 8"		
Guardrails and Handrails (Section R312 & R311.5.6 - R311.5.6.3) N/A - not over 30" front & side		
Smoke Detectors (Section R313) Location and type/interconnected	condition	
Dwelling Unit Separation (Section R317) and IBC - 2003 (Section 1207)	N/A	
Deck Construction (Section R502.2.1)	Not building deck	

Ann Machado - 5 Eastman Avenue Portland Main

From: DEBBIE KILMARTIN <dkilmartin@msn.com>
To: Ann Machado <amachado@portlandmaine.gov>
Date: 8/24/2010 2:54 PM
Subject: 5 Eastman Avenue Portland Main

Hi Ann,

How are you? The garage has been torn down. What is my next step?

Can I get my building permit or something saying my lot is all approved and meets all the set backs.

Need to get my release from my mortgage holder and they are asking for something.

I am ready for permit when you are ready to issue. HOW long does it take.

Sorry to not know all my steps or should say sorry to be really slow.

Thanks Debbie Kilmartin
174 Barnstable Road
South Portland Maine
207 807-7370

Ann Machado - RE: 5 Eastman Avenue, Portland Maine

From: Ann Machado
To: DEBBIE KILMARTIN
Date: 2/11/2010 1:33 PM
Subject: RE: 5 Eastman Avenue, Portland Maine

Debbie -

Since zoning and the development review coordinator have given their approval, I would go ahead and apply for the demolition permit, since your building permit can't be issued until the garage has been demolished.

Ann

>>> DEBBIE KILMARTIN <dkilmartin@msn.com> 2/11/2010 1:07 PM >>>

Hi Ann,
Do you think I am ok to start getting my demolition permit and start emptying the garage. Thanks Debbie

Date: Mon, 11 Jan 2010 11:13:25 -0500
From: AMACHADO@portlandmaine.gov
To: dkilmartin@msn.com
Subject: Re: 5 Eastman Avenue, Portland Maine

Debbie -

Your siteplan for the proposed single family home at 5 Eastman Avenue now meets the zoning requirements. Phil DiPierro (Development Review Coordinator) has signed off on the siteplan for planning. The only review remaining is by a plan reviewer who is a building inspector who will review the building plans.

Your permit cannot be issued until you apply for a demolition permit to remove the existing garage and it is physically removed.

Ann Machado
Zoning Specialist
207.874.8709

>>> DEBBIE KILMARTIN <dkilmartin@msn.com> 01/08 3:28 PM >>>

Hi Ann,

I would like to remove the deck from the plan of 5 Eastman Avenue, Portland Maine.

I would like to add a bulkhead to the back of the house. Thanks Debbie Kilmartin

Hotmail: Trusted email with powerful SPAM protection. [Sign up now.](#)

Hotmail: Trusted email with Microsoft's powerful SPAM protection. [Sign up now.](#)

--
Mony Hang
Associate Broker
Benchmark Real Estate
95 India St 2nd Floor

Ann Machado - Re: 5 Eastman Avenue, Portland Maine

From: Ann Machado
To: DEBBIE KILMARTIN
Date: 1/11/2010 11:13 AM
Subject: Re: 5 Eastman Avenue, Portland Maine

Debbie -

Your siteplan for the proposed single family home at 5 Eastman Avenue now meets the zoning requirements. Phil DiPierro (Development Review Coordinator) has signed off on the siteplan for planning. The only review remaining is by a plan reviewer who is a building inspector who will review the building plans.

Your permit cannot be issued until you apply for a demolition permit to remove the existing garage and it is physically removed.

Ann Machado
Zoning Specialist
207.874.8709

>>> DEBBIE KILMARTIN <dkilmartin@msn.com> 01/08 3:28 PM >>>

Hi Ann,

I would like to remove the deck from the plan of 5 Eastman Avenue, Portland Maine.

I would like to add a bulkhead to the back of the house. Thanks Debbie Kilmartin

Hotmail: Trusted email with powerful SPAM protection. [Sign up now.](#)

Hotmail: Trusted email with Microsoft's powerful SPAM protection. [Sign up now.](#)

--
Mony Hang
Associate Broker
Benchmark Real Estate
95 India St 2nd Floor
Portland, ME 04101
207-636-6669 (c)
888-234-8849 (f)
www.monyhang.com

Hotmail: Free, trusted and rich email service. [Get it now.](#)

5 Eastman Ave.

Ann Machado - 22 Bailey Ave. - Single Family Site Plan Review - #2009-0075

From: Philip DiPierro
To: Code Enforcement & Inspections
Date: 1/8/2010 11:19 AM
Subject: 22 Bailey Ave. - Single Family Site Plan Review - #2009-0075

Hi all, this project meets minimum DRC site plan requirements for the issuance of building permit. Please UI for sign-off.

Thanks.

Phil

Ann Machado - 5 Eastman Avenue, Portland Maine

From: DEBBIE KILMARTIN <dkilmartin@msn.com>
To: <amachado@portlandmaine.gov>
Date: 1/8/2010 4:44 PM
Subject: 5 Eastman Avenue, Portland Maine

Hi Ann,

I would like to remove the deck from the plan of 5 Eastman Avenue, Portland Maine.

I would like to add a bulkked to the back of the house. Thanks Debbie Kilmartin

Hotmail: Trusted email with powerful SPAM protection. [Sign up now.](#)

Hotmail: Trusted email with Microsoft's powerful SPAM protection. [Sign up now.](#)

--
Mony Hang
Associate Broker
Benchmark Real Estate
95 India St 2nd Floor
Portland, ME 04101
207-636-6669 (c)
888-234-8849 (f)
www.monyhang.com

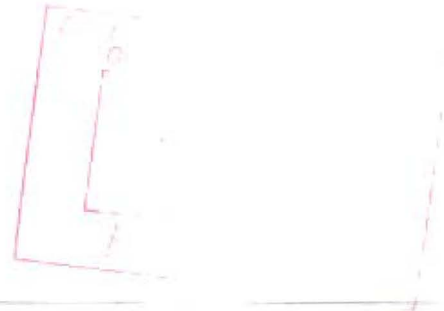

Hotmail: Free, trusted and rich email service. [Get it now.](#)

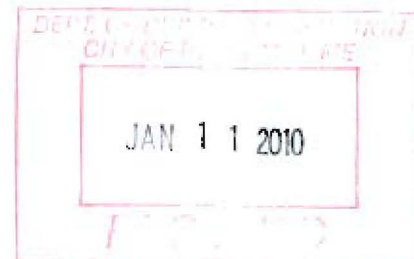

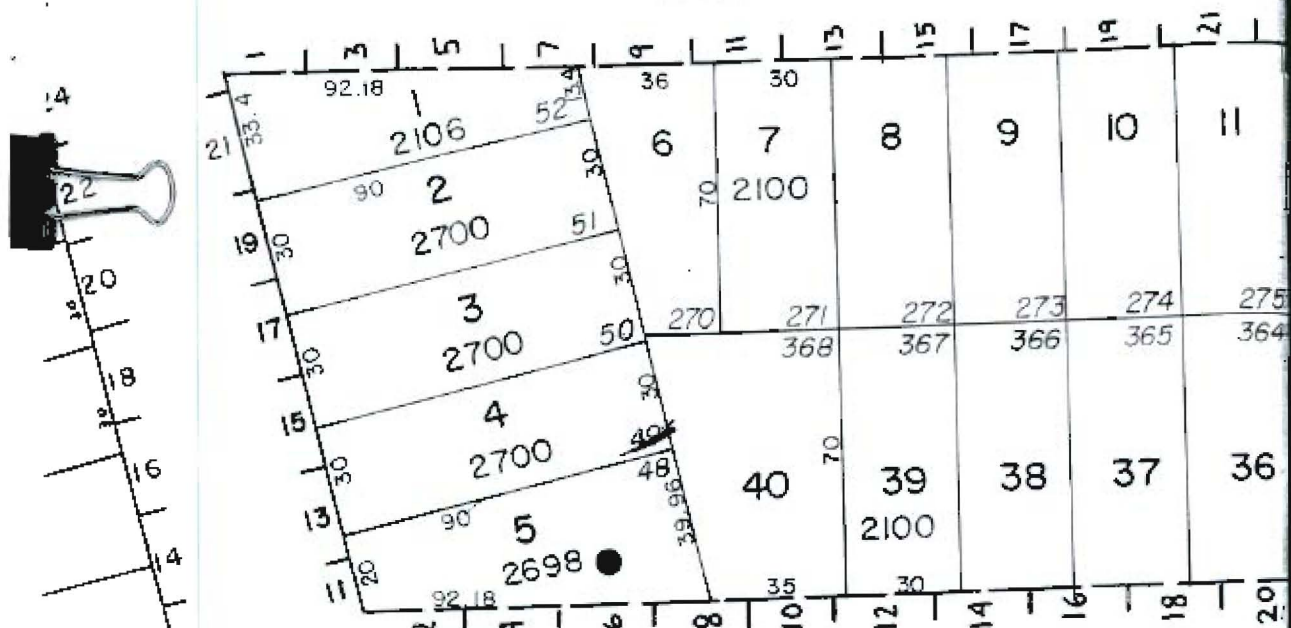

EASTMAN

TARBELL

1-2-6

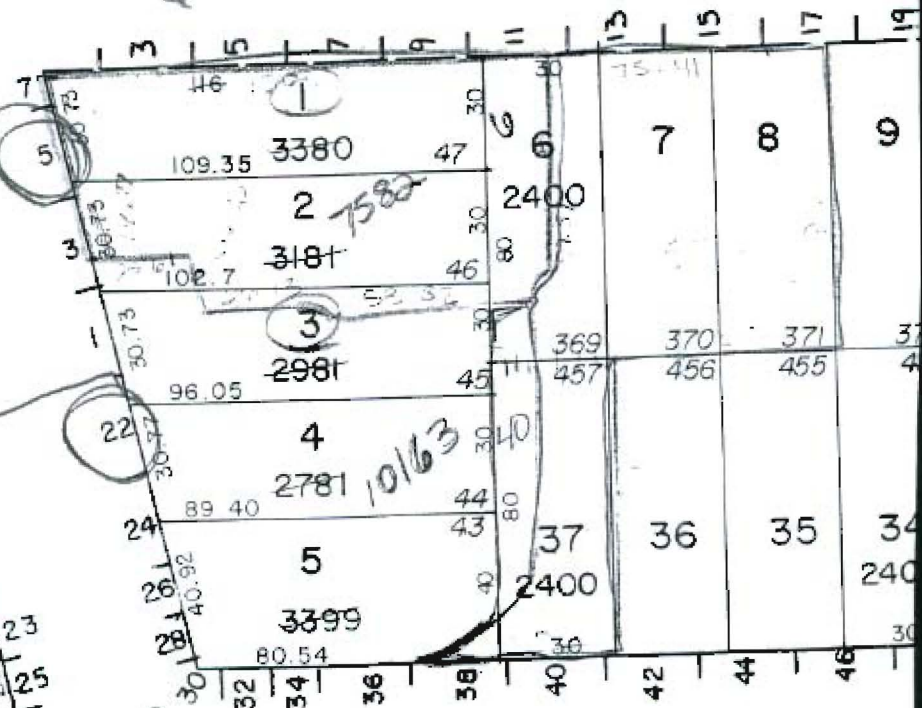

15
1700
16
3600

AVE.

BAILEY

W-4-5-10

43
17379

42 1 2 3 4 5
2394 2460 2050 2460

CITY OF PORTLAND, MAINE
 DEVELOPMENT REVIEW APPLICATION
 PLANNING DEPARTMENT PROCESSING FORM
 Zoning Copy

2009-0076
 Application I. D. Number

Kilmartin Sidney P &
 Applicant
 174 Barnstable Rd , South Portland , ME 04106
 Applicant's Mailing Address

Marge Schmuckal

10/20/2009
 Application Date

Deb Kilmartin
 Consultant/Agent
 Agent Ph: (207)807-7370 Agent Fax:
 Applicant or Agent Daytime Telephone, Fax

22 - 22 Bailey Ave, Portland, Maine
 Address of Proposed Site
 332 G001001
 Assessor's Reference: Chart-Block-Lot

Project Name/Description

Proposed Development (check all that apply): New Building Building Addition Change Of Use Residential Office Retail
 Manufacturing Warehouse/Distribution Parking Lot Apt 0 Condo 0 Other (specify)

0

Proposed Building square Feet or # of Units Acreage of Site Proposed Total Disturbed Area of the Site Zoning

Check Review Required:

- | | | | |
|-----------------------------------------------------------|---------------------------------------------------|------------------------------------------------|--------------------------------------------------|
| <input type="checkbox"/> Site Plan (major/minor) | <input type="checkbox"/> Zoning Conditional - PB | <input type="checkbox"/> Subdivision # of lots | <input type="checkbox"/> Design Review |
| <input type="checkbox"/> Amendment to Plan - Board Review | <input type="checkbox"/> Zoning Conditional - ZBA | <input type="checkbox"/> Shoreland | <input type="checkbox"/> DEP Local Certification |
| <input type="checkbox"/> Amendment to Plan - Staff Review | | <input type="checkbox"/> Zoning Variance | <input type="checkbox"/> Historic Preservation |
| <input type="checkbox"/> After the Fact - Major | | <input type="checkbox"/> Stormwater | <input type="checkbox"/> Flood Hazard |
| <input type="checkbox"/> After the Fact - Minor | | <input type="checkbox"/> PAD Review | <input type="checkbox"/> Traffic Movement |
| | | | <input type="checkbox"/> Housing Replacement |
| | | | <input type="checkbox"/> Other |
| | | | <input type="checkbox"/> 14-403 Streets Review |

Fees Paid: Site Plan \$50.00 Subdivision _____ Engineer Review \$250.00 Date 10/20/2009

Zoning Approval Status:

Reviewer

- Approved Approved w/Conditions See Attached Denied

Approval Date Approval Expiration Extension to Additional Sheets Attached

Condition Compliance

signature

date

Performance Guarantee Required* Not Required

* No building permit may be issued until a performance guarantee has been submitted as indicated below

- | | | | |
|-------------------------------------------------------------|----------------------|----------------------------------------------------|-----------------------|
| <input type="checkbox"/> Performance Guarantee Accepted | _____ date | _____ amount | _____ expiration date |
| <input type="checkbox"/> Inspection Fee Paid | _____ date | _____ amount | |
| <input type="checkbox"/> Building Permit Issue | _____ date | | |
| <input type="checkbox"/> Performance Guarantee Reduced | _____ date | _____ remaining balance | _____ signature |
| <input type="checkbox"/> Temporary Certificate of Occupancy | _____ date | <input type="checkbox"/> Conditions (See Attached) | _____ expiration date |
| <input type="checkbox"/> Final Inspection | _____ date | _____ signature | |
| <input type="checkbox"/> Certificate Of Occupancy | _____ date | | |
| <input type="checkbox"/> Performance Guarantee Released | _____ date | _____ signature | |
| <input type="checkbox"/> Defect Guarantee Submitted | _____ submitted date | _____ amount | _____ expiration date |
| <input type="checkbox"/> Defect Guarantee Released | | | |

GENERAL NOTES:

- All work shall be in accordance with BOCA Basic Building Code, NFPA-70 National Electric Code, Maine State Plumbing Code, ASHRAE, U.L., NFPA Codes, American with Disabilities Act 1990 (ADA) and all local, State and Federal requirements.
- All applicable Federal, State and Municipal regulations shall be followed, including the Federal Department of Labor Occupational Safety and Health act.
- All required City and State permits must be obtained before any construction begins.
- It is the contractor's sole responsibility to determine section procedures and sequence to ensure the safety of the building and its components during erection. This includes the addition of necessary shoring, sheathing, temporary bracing, guy or tie-downs. Such material shall remain the property of the contractor after completion of the project.
- Structural, Mechanical, Electrical and Plumbing design and installation by others shall be performed in accordance with local, State and Federal standards.
- All the reoffs indicated shall be continuous to underside of the rafter ceiling or underside of roof deck. Seal all openings & mechanical penetrations with approved fire sealing material.
- Building shall have approved smoke detectors in accordance with NFPA-70 Life Safety Code. Smoke detectors shall initiate alarm that is audible in the sleeping rooms of each unit.
- Portable fire extinguishers shall be provided in all hazardous areas in accordance to NFPA-101. Local authority having jurisdiction needs to provide written requirements.
- Staircases must maintain a 42" general height and shall be kept free and clear of ice and snow at all times to ensure the second means of egress.
- MVC installation to be in accordance with ASHRAE, NFPA-90A, OR NFPA-90B and all of Federal, local and State codes. Ventilation or heat exchanger shall be in accordance with NFPA-91, NFPA-211, NFPA-31, NFPA-34 and NFPA-70 as applicable.

FOUNDATION NOTES:

- PROVIDE SILL SEALER ON TOP OF ALL FOUNDATION WALLS.
- FOUNDATION WALLS SHALL BE BACKFILLED SIMULTANEOUSLY ON BOTH SIDES.
- ALL STEEL REINFORCING IN FOOTINGS TO BE A MINIMUM 3" CLEAR FROM BOTTOM OF FOOTING.
- ALL STEEL REINFORCING IN FOUNDATION WALLS BELOW GRADE TO BE MINIMUM OF 2" CLEAR FROM FACE OF WALL.
- ALL WOOD IN CONTACT WITH CONCRETE SHALL BE PRESURE PRESERVATIVE TREATED W/C.A TO 0.44/03 RETENTION PER NFPA.
- ALL CONCRETE SURFACES SHALL HAVE A STEEL TROWEL & LIGHT BROOM FINISH.
- SET BOTTOM OF FOOTINGS MIN. 4'-0" BELOW GRADE.
- SET ALL FOOTINGS ON UNDISTURBED SOIL OR COMPACTED STRUCTURAL FILL.
- RADIANT HEAT IN SLAB.
- FIRST FLOOR SLAB SHALL BE 4" THICK CONCRETE SLAB ON GRADE W/ FIBER MESH REINFORCEMENT. PROVIDE CONTROL JOINTS @ 10' MAX SPACING (2253F).
- ALL CONCRETE SHALL BE 3000 PSI (f_c) STRENGTH AT 28 DAYS.
- ALL CONCRETE SHALL BE AIR ENTRAINED 4-6%/.
- ALL OTHER ADJUSTURES SHALL BE PRE-APPROVED.
- WATERPROOFING / DAMP PROOFING ASPHALT TAR.
- PROVIDE FILTER FABRIC OVER STONE.

FRAMING NOTES:

- ALL EXTERIOR WALLS TO BE 2X4 WOOD STUD WALLS @ 24" O.C. W/ 1/2" G.W.B. AND VAPOR BARRIER @ INSIDE FACE OF WALL, 6" BATT INSULATION (R-10) AND 7/16" APA RATED SHEATHING @ EXTERIOR FACE OF WALL.
- ALL INTERIOR WALLS TO BE 2X4 WOOD STUD WALLS (UNLESS NOTED OTHERWISE) W/ ONE LAYER 1/2" G.W.B. EACH SIDE.
- INSTALL BLOCCING BEHIND ALL SURFACE APPLIED FIXTURES, TRIM, AND SHELVES WHEN MOUNTED ON WALLS.
- THE LOCATION OF ALL DOOR FRAMES SHALL BE 4 1/2" (UNLESS NOTED OTHERWISE) FROM ADJACENT WALLS.

HEADER SCHEDULE

ROUGH OPENING	HEADER SIZE
0 - 5'-0"	(3) - 2x6
5'-1" - 4'-8"	(3) - 2x8
4'-7" - 5'-0"	(3) - 2x10
5'-0" - 7'-0"	(3) - 2x12

NOTE: PROVIDE JACKS BOTH ENDS AS FOLLOWS:
 2x6 JACK PLUS 2x6 KING UP TO 4'-8" ROUGH OPENING
 (2) 2x6 JACKS PLUS (2) 2x6 KINGS UP TO 7'-0" ROUGH OPENING

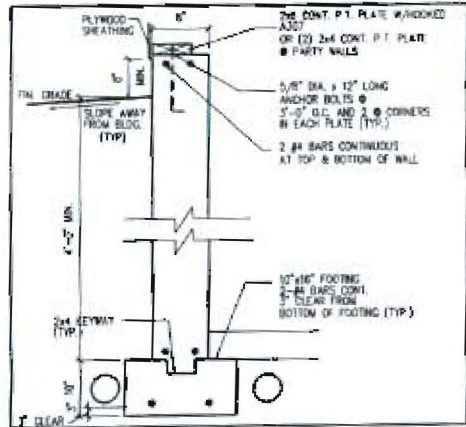

1 TYPICAL FOUNDATION WALL SCALE: 1/4" = 1'-0"

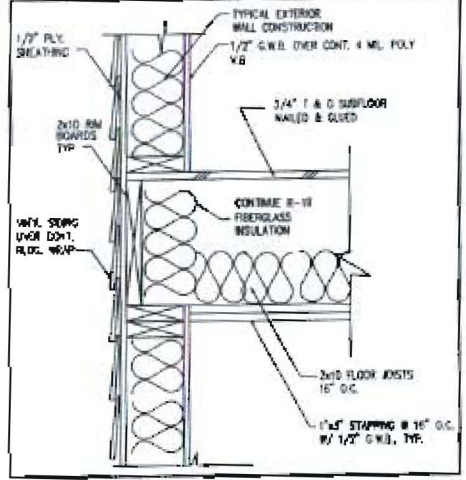

2 FLOOR FRAMING DETAIL 1/2" = 1'-0"

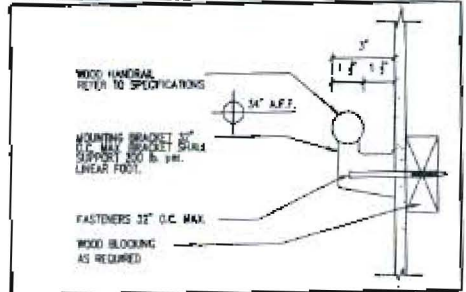

HANDRAIL DETAIL 1/2"

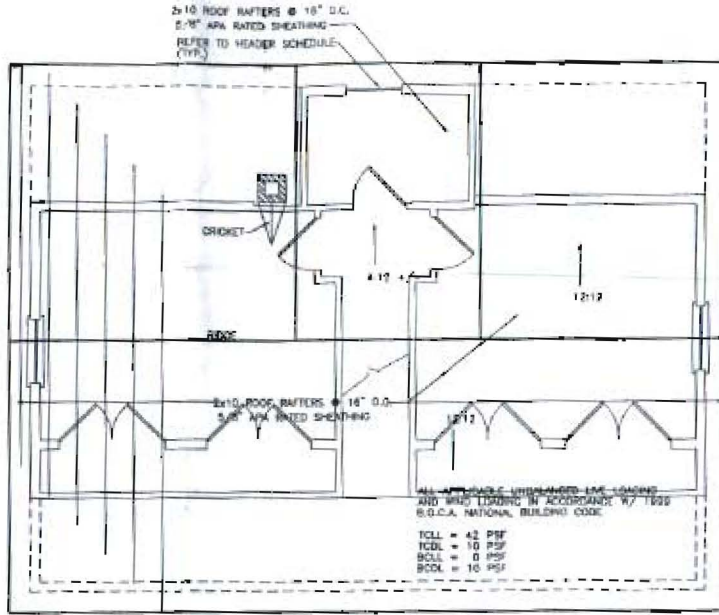

ROOF FRAMING PLAN
SCALE: 1/4" = 1'-0"

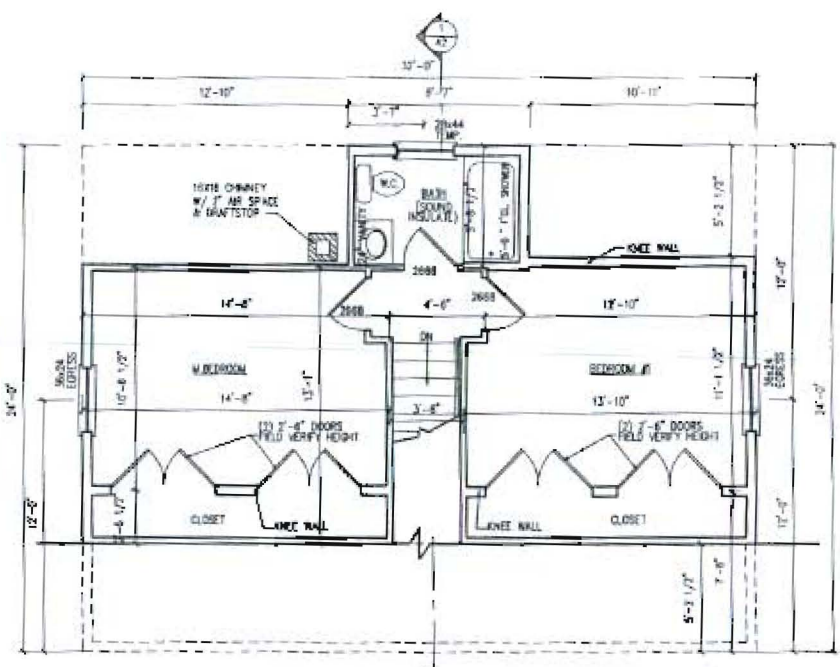

SECOND FLOOR PLAN
SCALE: 1/4" = 1'-0"

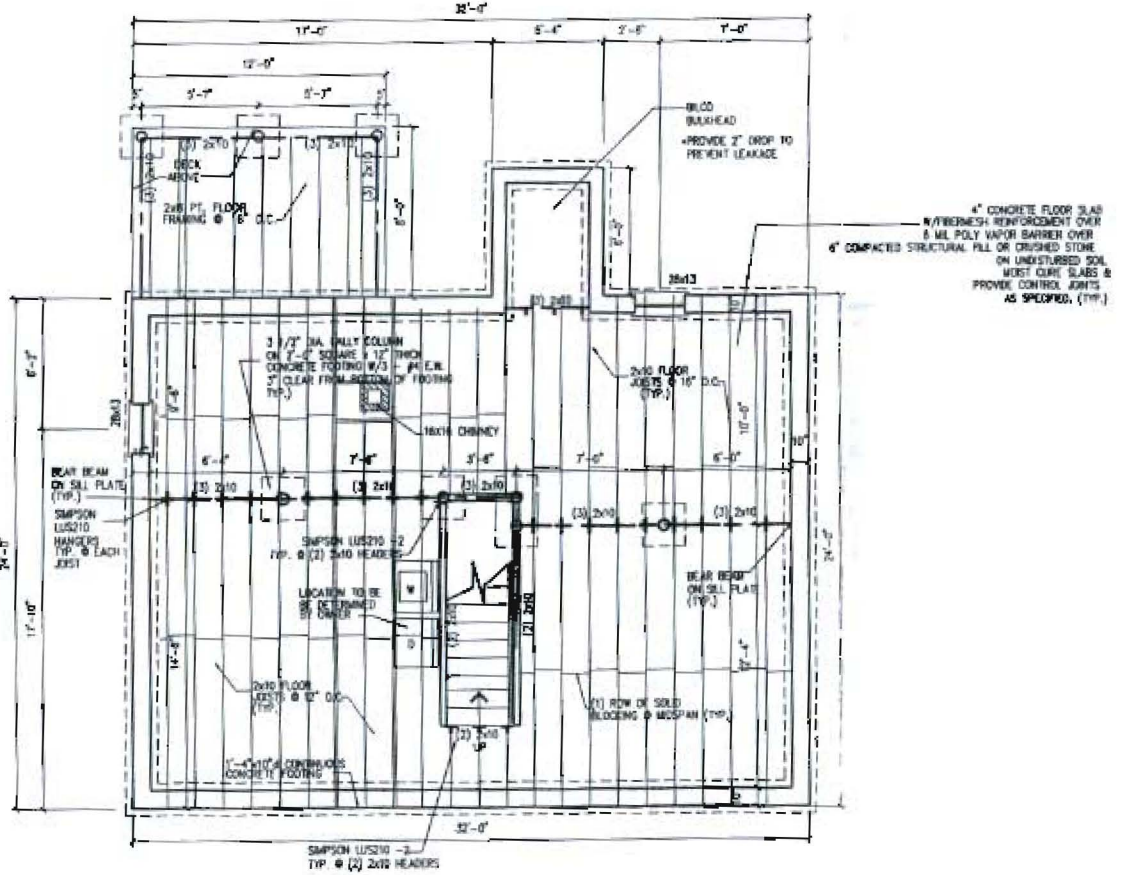

FOUNDATION / FIRST FLOOR FRAMING PLAN
SCALE: 1/4" = 1'-0"

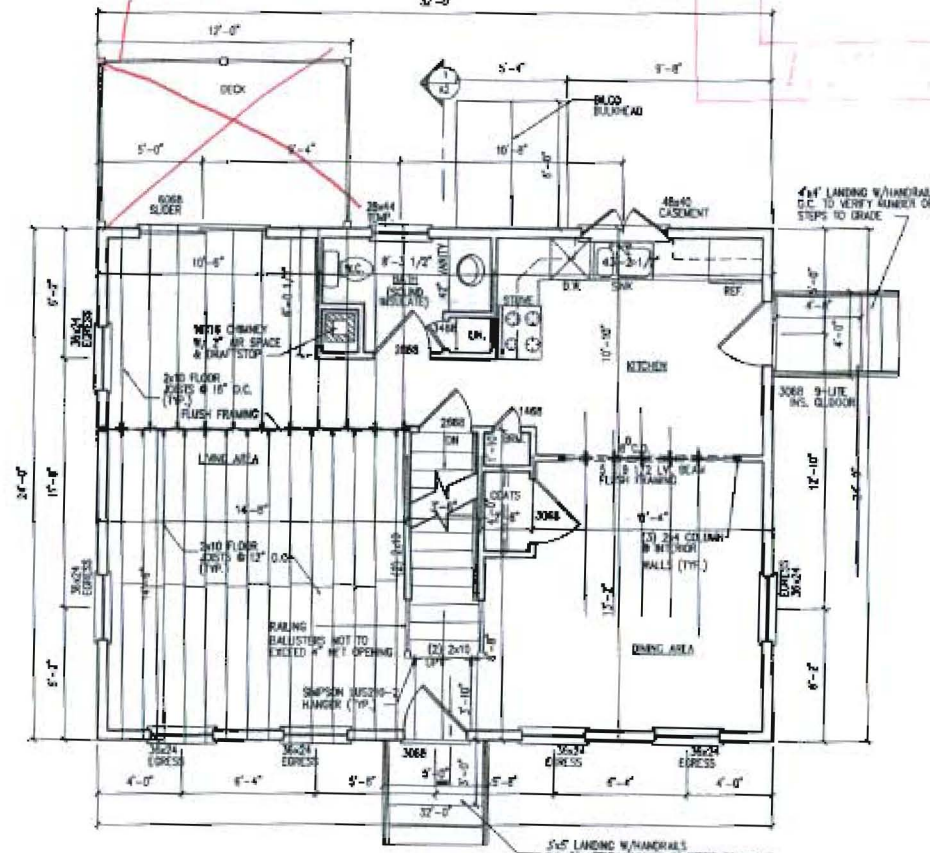

FIRST FLOOR PLAN
SCALE: 1/4" = 1'-0"

nodack see email about rec'd 11/10/10

JAN - 6 2010

24 x 32 CAPE

FOUNDATIONS & ROOF PLAN
 FIRST FLOOR PLAN /
 SECOND FLOOR PLAN /
 NOTES / DETAILS

DATE
 04/17/08

A1

TYPICAL ROOF CONSTRUCTION

- ROOF VENT
- PRE-MANUFACTURED ROOF TRUSSES @ 24" O.C.
- ROOF SHEATHING
- 5/8" APA RATED SHEATHING W/ 3/4" NAILS @ 16" SHAP @ 4" O.C. PANEL EDGES AND 4" O.C. INTERMEDIATE
- INSULATION
- 25 YEAR FIBERGLASS SHINGLES
- 1/2" FELT PAPER
- (2) BILLS 30" WIDE WATERPROOF MEMBRANE @ GUTTERS

ROUGH OPENING	HEADER SIZE
0 - 5'-0"	(2) - 2x4
5'-0" - 6'-0"	(2) - 2x6
6'-0" - 7'-0"	(2) - 2x8
7'-0" - 8'-0"	(2) - 2x10
8'-0" - 9'-0"	(2) - 2x12

NOTE: PROVIDE JAMBS BOTH ENDS AS FOLLOWS:
 (1) 2x6 JOCK PLUS 2x6 END UP TO 4'-0" ROUGH OPENING
 (2) 2x6 JOCKS PLUS (2) 2x6 ENDS UP TO 7'-0" ROUGH OPENING

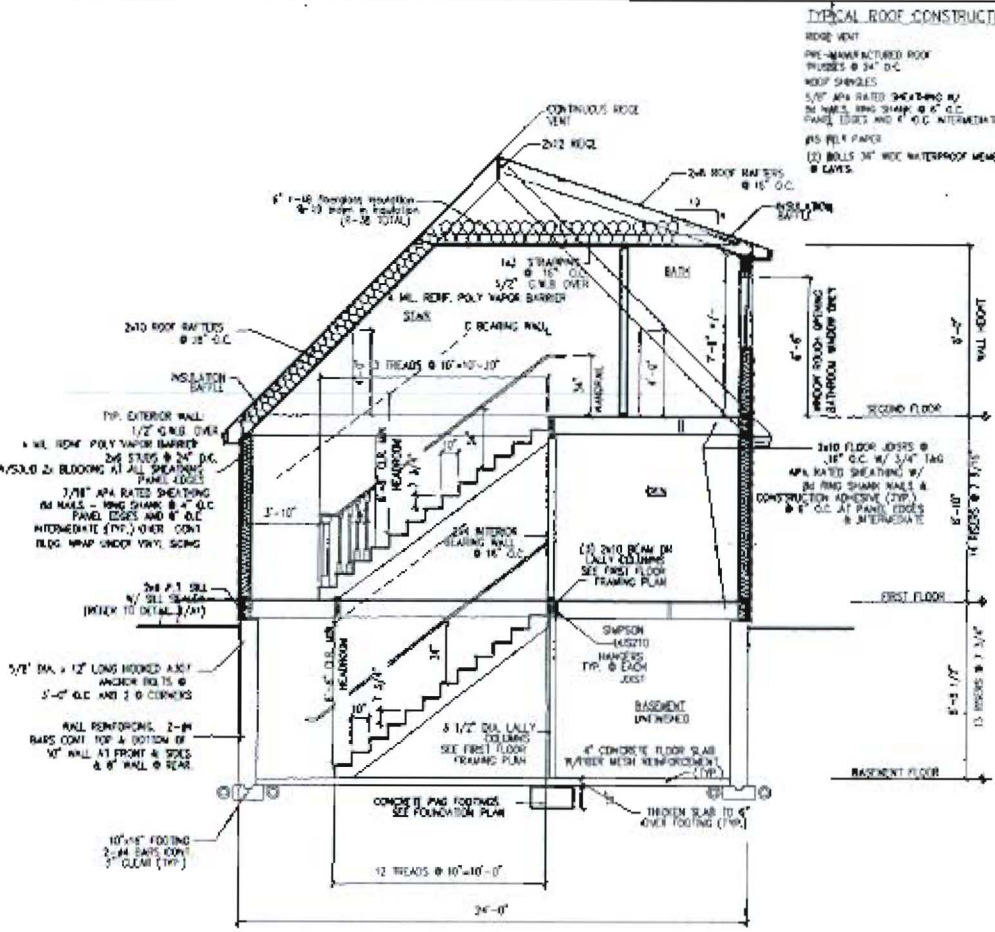

SECTION THRU HOUSE
SCALE: 1/4" = 1'-0"

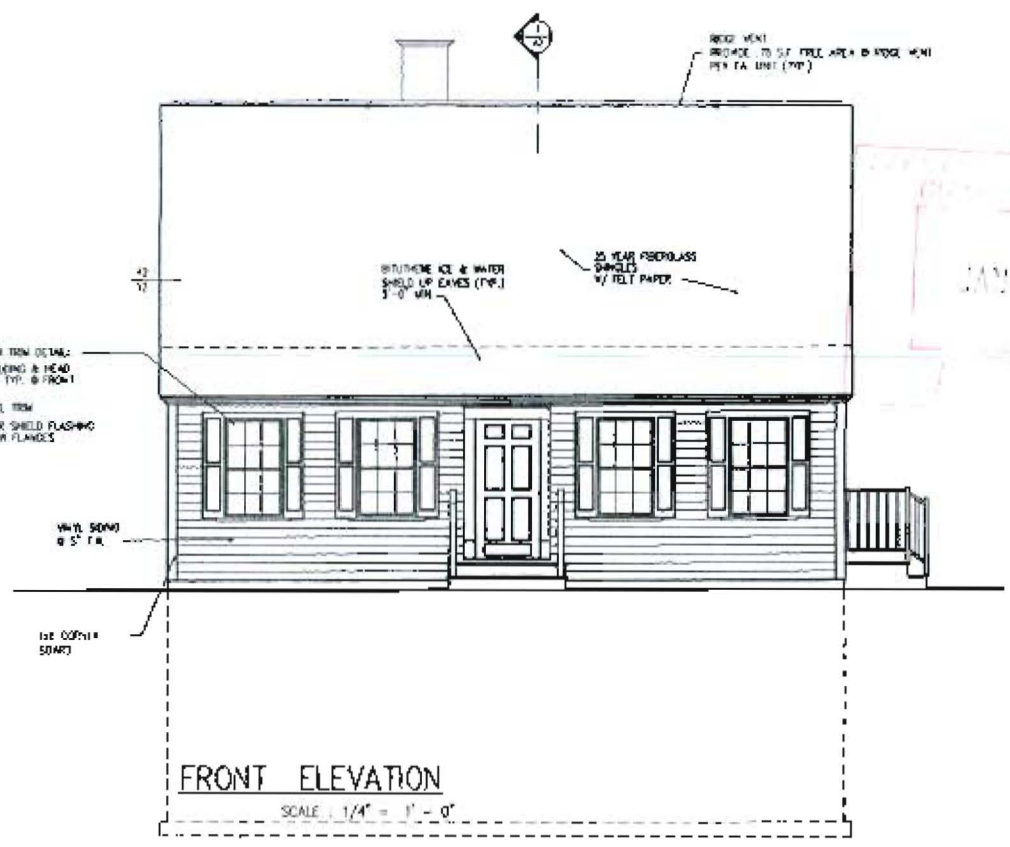

FRONT ELEVATION
SCALE: 1/4" = 1'-0"

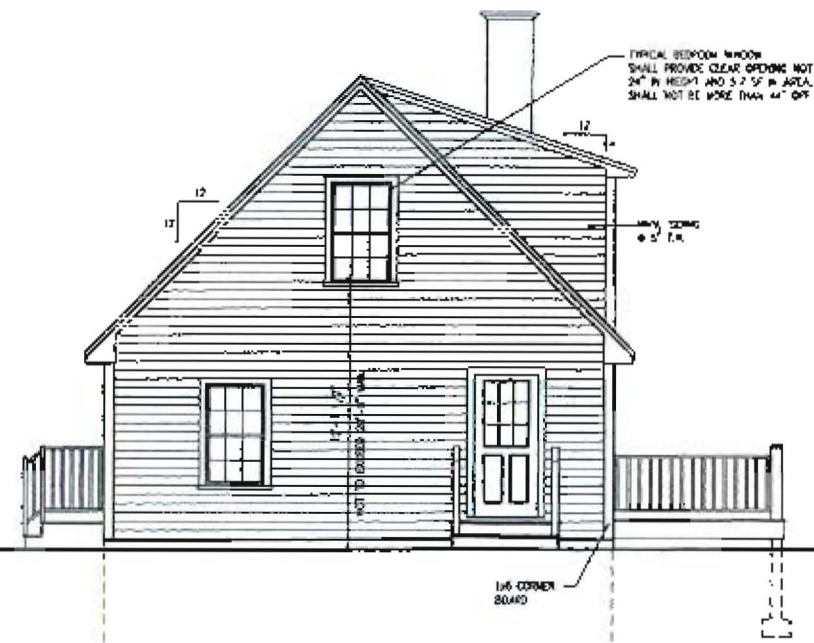

RIGHT SIDE ELEVATION
SCALE: 1/4" = 1'-0"

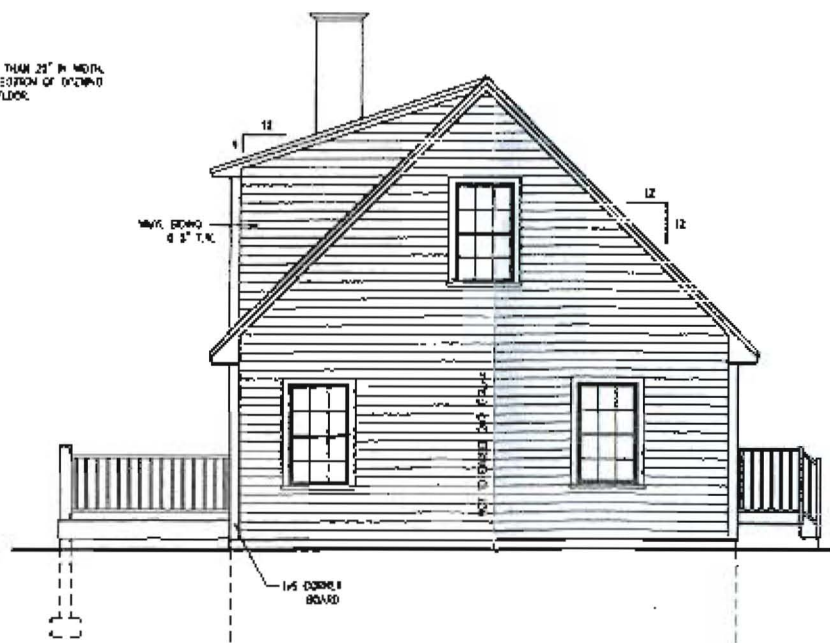

LEFT SIDE ELEVATION
SCALE: 1/4" = 1'-0"

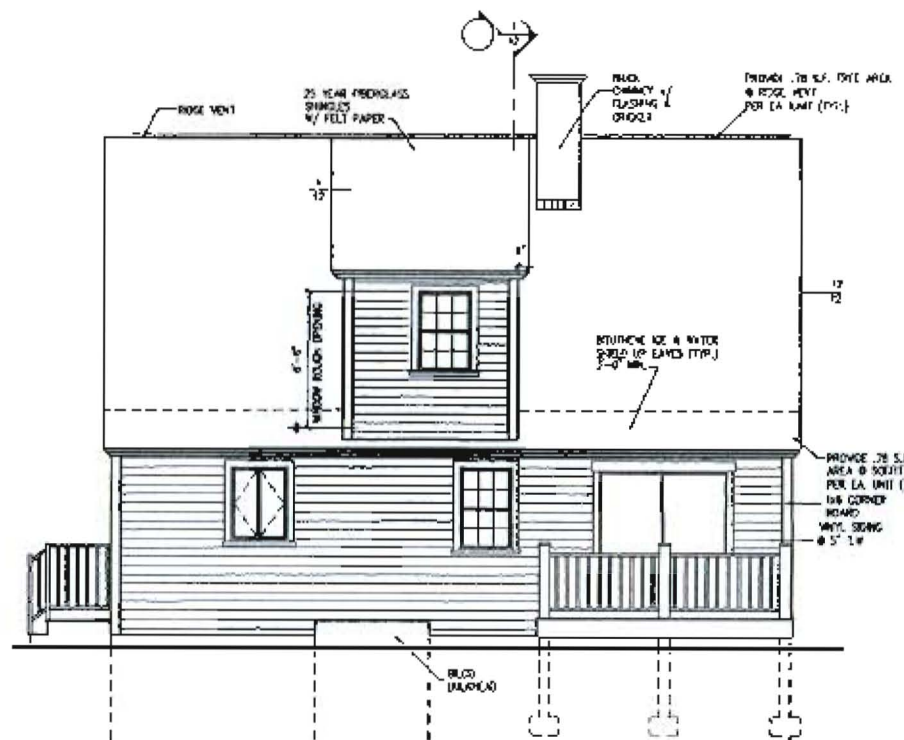

REAR ELEVATION
SCALE: 1/4" = 1'-0"

JAN - 6 2010

24 x 32 CAPE

DRAWING THIS SHEET
ELEVATIONS / SECTION

04/17/08

A2

GENERAL NOTES:

1. REQUIRED DIMENSIONS OF PARCEL: SEE MAP P. 6 DEBORAH KILMARTIN, ITS BOOK 20794 PAGE 318 AS RECORDED IN THE CUMBERLAND COUNTY REGISTRY OF DEEDS (CGD).
2. THIS SURVEY WAS COMPLETED UTILIZING THE FOLLOWING EQUIPMENT:
 LEICA DISTANCE MEASUREMENT SYSTEM (DMS) WITH 3X DATA COLLECTOR
 LEICA TOTAL STATION (TS) WITH 3X DATA COLLECTOR
 LEICA AUTO LEVEL WITH 3X DATA COLLECTOR
 LEICA GNSS RECEIVER WITH 3X DATA COLLECTOR
 LEICA DISTANCE MEASUREMENT SYSTEM (DMS) WITH 3X DATA COLLECTOR
 LEICA TOTAL STATION (TS) WITH 3X DATA COLLECTOR
 LEICA AUTO LEVEL WITH 3X DATA COLLECTOR
 LEICA GNSS RECEIVER WITH 3X DATA COLLECTOR

3. THIS SURVEY WAS COMPLETED UTILIZING THE FOLLOWING EQUIPMENT:
 LEICA DISTANCE MEASUREMENT SYSTEM (DMS) WITH 3X DATA COLLECTOR
 LEICA TOTAL STATION (TS) WITH 3X DATA COLLECTOR
 LEICA AUTO LEVEL WITH 3X DATA COLLECTOR
 LEICA GNSS RECEIVER WITH 3X DATA COLLECTOR
4. ALL DIMENSIONS ARE BASED UPON THE MAINE STATE PLANE COORDINATE SYSTEM, WEST ZONE NORTH AMERICAN DATUM 1983. SMO BEARINGS DERIVED FROM COORDINATES SUPPLIED BY THE CITY OF PORTLAND'S ENGINEERING DEPARTMENT. TWO POINTS ON THE THREE FOOT OFFSET FROM THE CENTERLINE OF THE STREET ARE USED TO DETERMINE THE INTERSECTION OF THE STREET CENTERLINE WITH THE PROPERTY LINE. THE POINTS ARE IDENTIFIED AS NORTH-31-1407-040, EAST-31-1407-041, WEST-31-1407-042, AND SOUTH-31-1407-043. THE POINTS ARE IDENTIFIED AS NORTH-31-1407-040, EAST-31-1407-041, WEST-31-1407-042, AND SOUTH-31-1407-043. THE POINTS ARE IDENTIFIED AS NORTH-31-1407-040, EAST-31-1407-041, WEST-31-1407-042, AND SOUTH-31-1407-043.

5. AREA OF SPECIAL INTEREST: SEE THE PLAN FOR AREAS OF THE PROPOSED LOTS.
6. REFERENCE IS MADE TO THE FOLLOWING PLANS:
 a.) FOREST AND WOODLAND PRESERVATION PLAN, OWNED BY JIMMIE L. DATED MAY 1978 BY ALLIANT, LLC, RECORDED IN THE CUMBERLAND COUNTY REGISTRY OF DEEDS PLAN BOOK 12 PAGE 3.
7. CITY OF PORTLAND ZONING PLAN NO. 332, REVISED 4/79.
8. CITY OF PORTLAND SEWER SHEETS.

9. THE ABOVE PARCELS ARE REQUESTED BY THE CITY OF PORTLAND AND THE CITY ENGINEER HAS REVIEWED THE PLAN IN CONNECTION WITH THE OTHER LOTS SHOWN ON SAID PLAN AND SUBJECT TO THE DEEDS OF THE OTHER LOTS TO MAKE ANY CUSTOMARY LIST OF SAID STREETS AND WAYS, IN ACCORDANCE WITH ABOVE REFERENCED DEEDS.
10. LOT TWO RECEIVED A ZONING BOARD OF APPEALS APPROVAL AS A RESIDENTIAL LOT ON MAY 4, 2004. LOTS ONE AND TWO AS SHOWN ON THIS PLAN MEET THE CURRENT ZONING STANDARDS AS BLDGABLE LOTS ACCORDING TO THE REQUIRED DISTANCE TO A PUBLIC STREET AND SQUARE FOOTAGE REQUIREMENTS FOR A LOT IN RESIDENTIAL ZONE R-1.
11. NO SPECIAL PROBLEMS WITH DRAINAGE ARE EXPECTED. LOT 3 IS CONSTRUCTING A STORMWATER TREATMENT SYSTEM TO TREAT ALL STORMWATER TO BE DISCHARGED TO THE STREET FLOW AND ABSORB ITS STORMWATER INTO ITS OWN LOT.
12. NO RETAINMENT OR SPECIAL SOILS ARE KNOWN TO EXIST ON THE SUBJECT PARCEL.

ZONING:
 ZONE: R-1
 DISTRICT: 1000
 DISTRICT NAME: 1000
 DISTRICT NUMBER: 1000
 DISTRICT TYPE: RESIDENTIAL
 DISTRICT CODE: R-1
 DISTRICT DESCRIPTION: RESIDENTIAL SINGLE-FAMILY
 DISTRICT OFFICIAL: CITY ENGINEER
 DISTRICT DATE: 10/1/09

FLOOD NOTES:
 FLOOD ZONE: 100-YEAR FLOOD ZONE
 FLOOD ELEVATION: 100-YEAR FLOOD ELEVATION
 FLOOD DATE: 10/1/09

- LEGEND:**
- 1. Contour 3/4" Elevation from reference
 - 2. Iron Pipe Found
 - 3. Spot Elevation
 - 4. Property Line
 - 5. Street Line
 - 6. Street Line
 - 7. Edge of Unexcavated
 - 8. Street This to be finished shall be in excess of 2-1/2 inches in diameter.

PROPOSED SINGLE FAMILY SITE PLAN
 AT: EASTMAN AVENUE, PORTLAND, MAINE
 FOR: DEBORAH KILMARTIN

PREPARED BY:
 OCEAN PARLAND SURVEYING, LLC
 P.O. BOX 7265
 OCEAN PARK, MAINE 04063
 (207)-748-8477 OCEANPARLANDSURVEYING.NET

REVISIONS:

NO.	DATE	DESCRIPTION
1	12-28-2009	REVISED AND RECORDED PROPOSED HOUSE
2	11-20-2009	REVISED PROPOSED DRIVEWAY & REMOVED PORCH
3	11-10-08	REVISED HOUSE, REVISED CONTOURS & ADDED ELECTRIC SERVICE

STATE OF MAINE, CUMBERLAND SS
 REGISTRY OF DEEDS
 RECEIVED AT: H. M. AND RECORDED IN PLAN BOOK PAGE 2009

LOCATION: EASTMAN AVE. PORTLAND, MAINE

SITE LOCATION MAP:

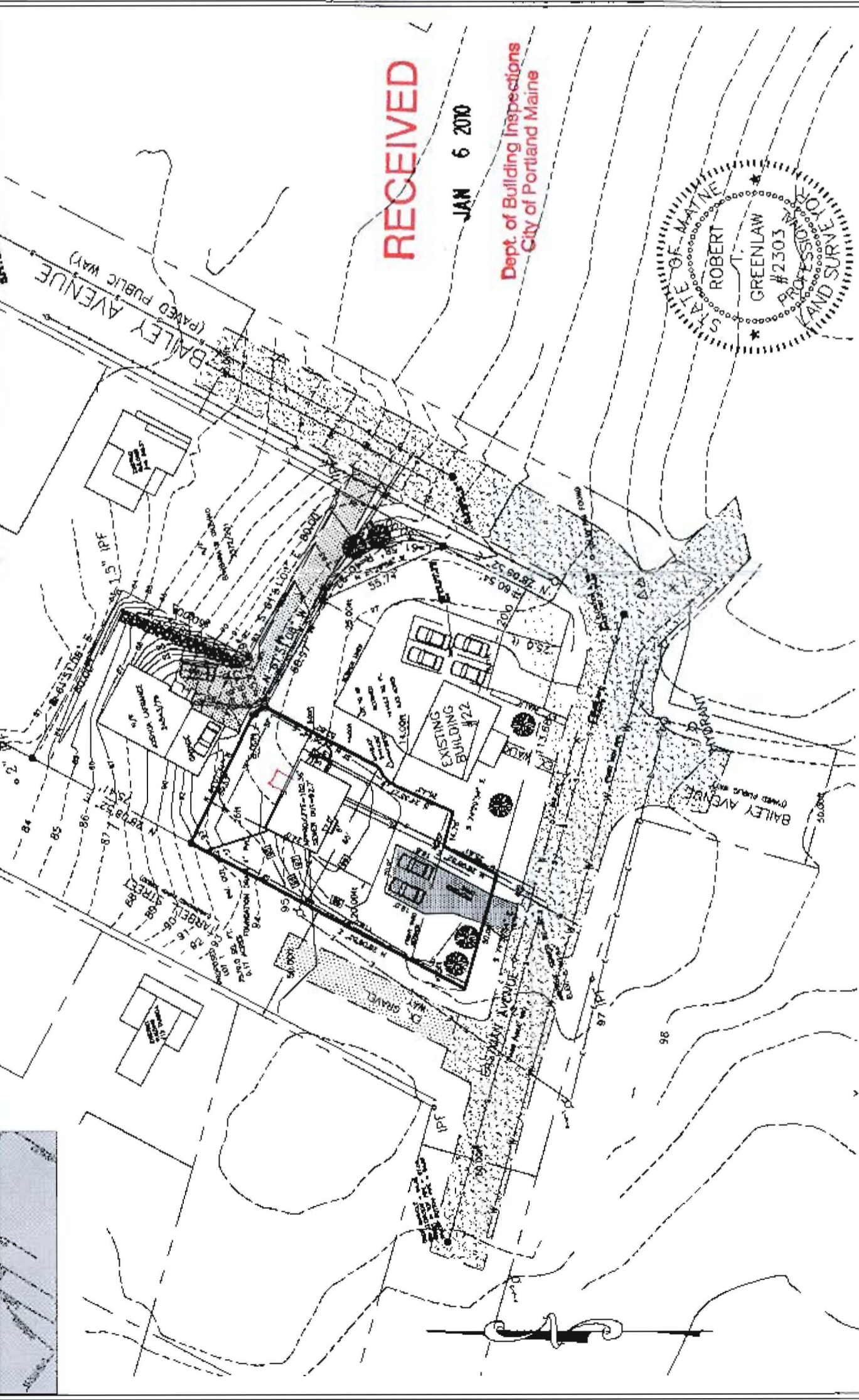
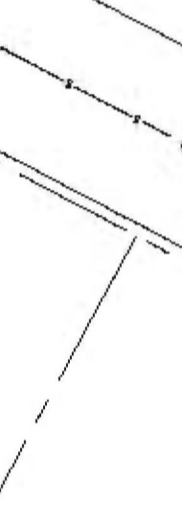

CERTIFICATE:
 I HEREBY CERTIFY THAT THIS SURVEY CONFORMS TO THE MAINE BOARD OF LICENSEURE FOR PROFESSIONAL LAND SURVEYING STANDARDS OF PRACTICE AS ADOPTED APRIL 01, 2009 WITH THE FOLLOWING EXCEPTIONS:
 a) NO LIMITED REPORT
 b) NO NEW CORNERS WERE SET
 ROBERT T. GREENLAW P.L.S., #2303
 DATE: FEBRUARY 08, 2009

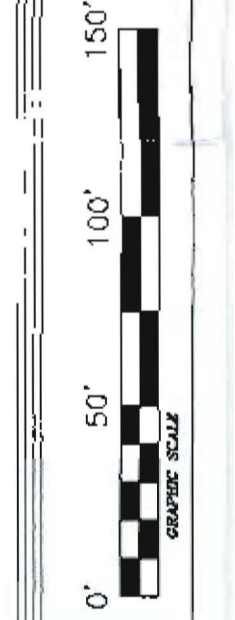

STATE OF MAINE, CUMBERLAND SS
 REGISTRY OF DEEDS
 RECEIVED AT: H. M. AND RECORDED IN PLAN BOOK PAGE 2009

SITE LOCATION MAP

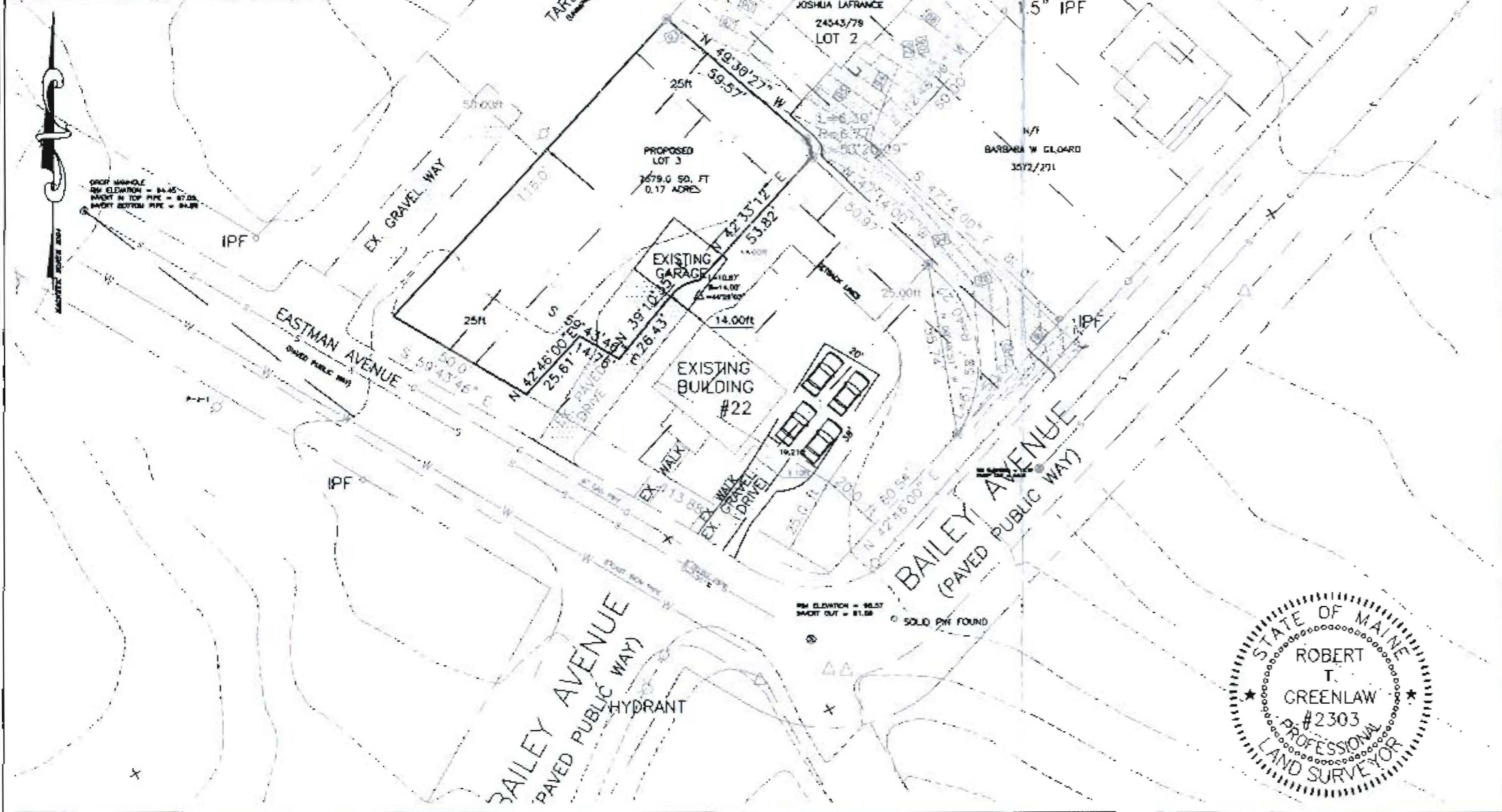

GENERAL NOTES:

1. RECORD OWNER OF PARCEL: SOVEY P & DEBORAH • KILMARTIN, JTS, BOOK 20704 PAGE 316 AS RECORDED IN THE CUMBERLAND COUNTY REGISTRY OF DEEDS (CCRD)
2. BEARINGS ARE BASED UPON A MAGNETIC OBSERVATION TAKEN AT THE TIME OF THIS SURVEY, UTILIZING THE FOLLOWING EQUIPMENT:
LEITZ SOLARISA SET 4 TOTAL STATION, LEITZ 50R 55 DATA COLLECTOR
NO STATE PLANE COORDINATES WERE AVAILABLE FOR THIS PROJECT WITHIN A 1/2 MILE OF THE SITE.
3. ELEVATIONS BASED UPON THE METERS OF THE TWO MANHOLES SHOWN HEREON AND THE ELEVATIONS OF SAID MANHOLES AS SHOWN ON SHEET #4 OF 3 OF THIS SET OF PLANS AND ON PLAN REFERENCE #4 BELOW. ELEVATIONS ARE ASSUMED TO BE ON CITY DATUM APPROXIMATELY N.T.M.D. 1929.
4. AREA OF ORIGINAL PARCEL:
ORIGINAL LOT 25,325.2 SQ. FT. 0.58 ACRES. SEE THE PLAN FOR AREAS OF THE PROPOSED LOTS.
5. REFERENCE IS MADE TO THE FOLLOWING PLANS:
a.) FOREST AVENUE TERRACE, PORTLAND MAINE, OWNED BY J.W. MILBUR, DATED MAY 7, 1950 BY A.L. ELIOT, C.E., RECORDED IN THE CUMBERLAND COUNTY REGISTRY OF DEEDS PLAN BOOK 12 PAGE 5
b.) CITY OF PORTLAND ASSESSORS PLAN NO. 352, UNDATED
6. THE ABOVE PARCELS ARE BENEFITTED BY THE EASES OF ALL THE STREETS AND WAYS SHOWN ON SAID PLAN, IN COMMON WITH THE OWNERS OF THE OTHER LOTS SHOWN ON SAID PLAN, AND SUBJECT TO THE RIGHT OF ALL OF SAID LOT OWNERS TO MAKE ANY CUSTOMARY USE OF SAID STREETS AND WAYS, IN ACCORDANCE WITH ABOVE RECORDED DEEDS.
7. LOT THREE RECEIVED A ZONING BOARD OF APPEALS APPROVAL AS A BUILDABLE LOT ON MAY 4, 2009. LOTS 1 AND 2 AS SHOWN ON THIS PLAN MEET THE CURRENT ZONING STANDARDS AS BUILDABLE LOTS ACCORDING TO THE REQUIRED FRONTAGE ON A PUBLIC STREET AND SQUARE FOOTAGE REQUIREMENTS FOR A LOT IN RESIDENTIAL ZONE R-1.

ZONING:

ZONE: R-1 RESIDENTIAL
SETBACKS: FRONT - 25 FT
 REAR - 25 FT
 SIDE - 1-1/2 STORY 8 FT, 2 STORY 14 FT
 ON SIDE STREET - 50 FT
MINIMUM LOT SIZE: 4000 SQ. FT.
MINIMUM LOT WIDTH: 50 FT
MINIMUM BUILDING HEIGHT: 35 FT
MINIMUM LOT COVERAGE: 24%

FLOOD NOTE:

BY GRAPHIC NOTING ONLY, THIS PROPERTY IS IN ZONE X OF THE FLOOD INSURANCE RATE MAP, COMMUNITY PANEL NO. 230001 BL, WHICH BEARS AN EFFECTIVE DATE OF DEC. 14, 1995 AND IS NOT IN A SPECIAL FLOOD HAZARD AREA.

LEGEND:

- Capped 5/8" Rebar Found
- IPF Iron Pipe Found
- Abutment Line
- Property Line
- Street Line
- Setback Line
- Edge of traveled way
- (50.00') Distance from reference Plan or Deed.
- N/F New Or Formerly
- TYP. TYPICAL
- Direction of Bearing
- Z Indicates Ownership in Common

rec'd 10/20/09



REVISIONS:

LOCATION: EASTMAN AVE. PORTLAND, MAINE

STATE OF MAINE, CUMBERLAND SS
 REGISTRY OF DEEDS

RECEIVED 2007
 AT 1 M. AND RECORDED IN
 PLAN BOOK PAGE

0' 40' 80' 120'
 GRAPHIC SCALE

CERTIFICATE:

I HEREBY CERTIFY THAT THIS SURVEY CONFORMS TO THE MAINE BOARD OF LICENSURE FOR PROFESSIONAL LAND SURVEYORS' STANDARDS OF PRACTICE AS ADOPTED APRIL 01, 2009 WITH THE FOLLOWING EXCEPTIONS:

- NO WRITTEN REPORT
- NO NEW CORNERS WERE SET

ROBERT T. GREENLAW P.L.S., #2303
 V. PRESIDENT BACK BAY BOUNDARY, INC.
 NEWSEID: FEBRUARY 02, 2006
 DATE: JULY 3, 2009

EXISTING CONDITIONS PLAN
 AT: EASTMAN AVENUE, PORTLAND, MAINE

FOR: **DEBORAH KILMARTIN**

PREPARED BY:
BACK BAY BOUNDARY, INC.
 LAND SURVEYING
 643 FOREST AVENUE
 PORTLAND, MAINE
 207-774-2855 FAX 207-347-4346

DRAWN BY: RTG
 CHECKED BY: MMR
 SCALE: 1" = 40'
 DATE OF SURVEY: 07/22/2009
 JOB NUMBER: 2004093
 SHEET: 1 OF 3
 DRAWER: 2004 NO. 069

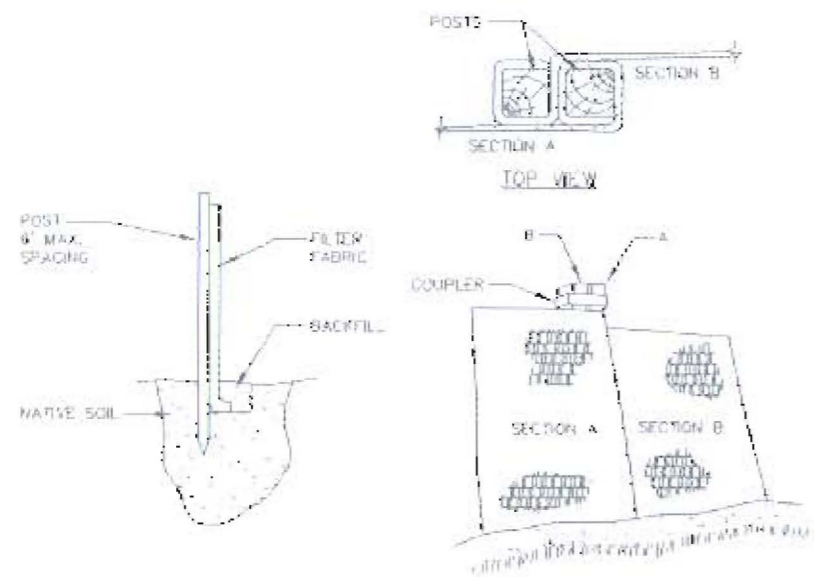

- INSTALLATION**
1. EXCAVATE A 6" x 6" TRENCH ALONG THE LINE OF PLACEMENT FOR THE FILTER BARRIER.
 2. UNROLL A SECTION AT A TIME AND POSITION THE POSTS AGAINST THE BACK (DOWNSTREAM) WALL OF THE TRENCH.
 3. DRIVE POSTS INTO THE GROUND UNTIL APPROXIMATELY 2" OF FABRIC IS LYING ON THE TRENCH BOTTOM JOIN SECTION AS SHOWN ABOVE.
 4. LAY THE TOE-IN FLAP OF FABRIC ONTO THE UNDISTURBED BOTTOM OF THE TRENCH. BACKFILL THE TRENCH AND TAMP THE SOIL. TOE-IN CAN ALSO BE ACCOMPLISHED BY LAYING THE FABRIC FLAP ON UNDISTURBED GROUND AND PILING AND TAMPING FILL AT THE BASE BUT MUST BE ACCOMPANIED BY AN INTERCEPTION DITCH.
 5. BARRIER SHALL BE WEAFI SILT FENCE OR APPROVED EQUAL.

FILTER BARRIER
NOT TO SCALE

STORM WATER CONNECTION AT RIGHT OF WAY FOR FUTURE CONNECTION OF STORM WATER PIPE TO STREET UNDERDRAIN SHOULD STREET BE REBUILT

4" SDR 35 PVC

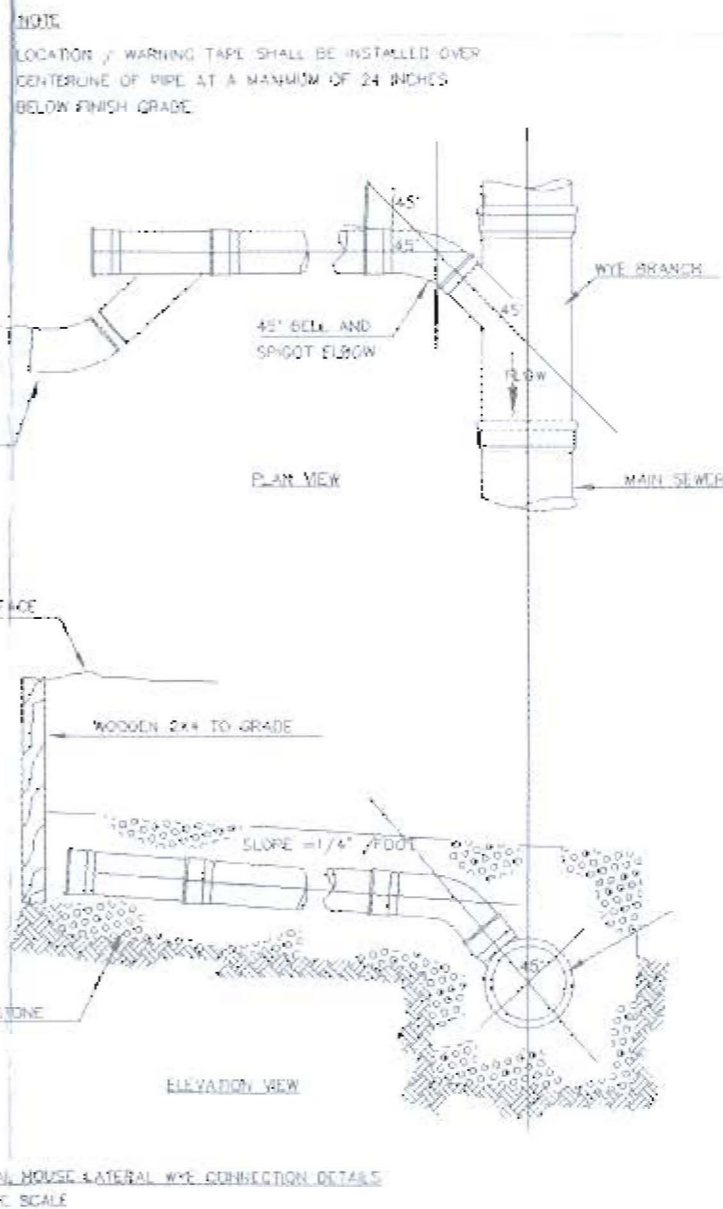

TYPICAL HOUSE LATERAL WYE CONNECTION DETAILS
NOT TO SCALE

NOTE:
LOCATION OF WARNING TAPE SHALL BE INSTALLED OVER CENTERLINE OF PIPE AT A MINIMUM OF 24 INCHES BELOW FINISH GRADE.

rec'd
10/20/09

DETAIL SHEET
AT: EASTMAN AVENUE, PORTLAND, MAINE

FOR: **DEBORAH KILMARTIN**

PREPARED BY:
OCEAN PARK LAND SURVEYING, LLC

P.O. BOX 7265
OCEAN PARK, MAINE 04063
207-749-9471 OCEANPARKLLC@GWI.NET

DRAWN BY: RTG
CHECKED BY: MMB
SCALE: NOT TO SCALE
DATE OF SURVEY: 07/22/2004
JOB NUMBER: 2009005
SHEET: 3 OF 3
DRAWER: 2009 NO: 006

REVISIONS:

LOCATION: EASTMAN AVE PORTLAND, MAINE

STATE OF MAINE, CUMBERLAND SS
REGISTRY OF DEEDS

RECEIVED 2009
AT : H M. AND RECORDED IN
PLAN BOOK PAGE

CERTIFICATE:
I HEREBY CERTIFY THAT THIS SURVEY CONFORMS TO THE MAINE BOARD OF LICENSURE FOR PROFESSIONAL LAND SURVEYORS' STANDARDS OF PRACTICE AS ADOPTED APRIL 01, 2001 WITH THE FOLLOWING EXCEPTIONS:
a) NO WRITTEN REPORT
b) NO NEW CORNERS WERE SET

ROBERT T. GREENLAW P.L.S., #2303 DATE: MARCH 30, 2009