

INTERIOR H.M. FRAME DETAILS

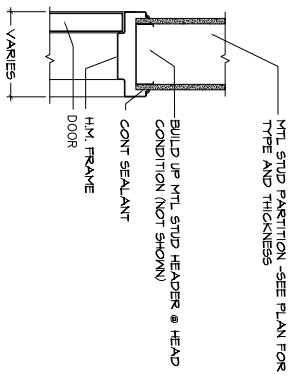

5 H.M. FRAME HEAD & JAMB @ CFME  
 1/2" x 1-0"

4 NOT USED

3 WINDOW TYPES  
 1/4" x 1-0"

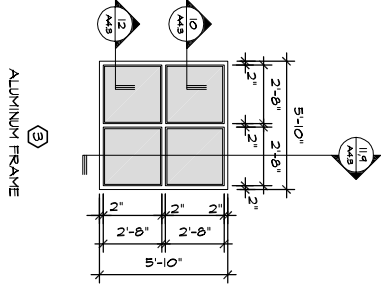
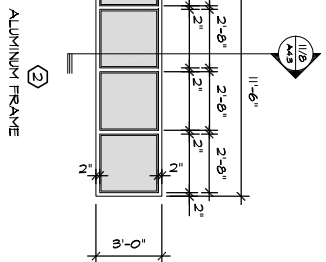
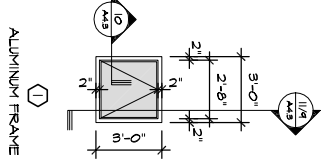

2 FRAME TYPES  
 1/4" x 1-0"

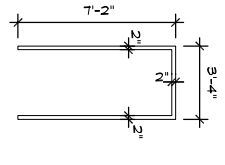
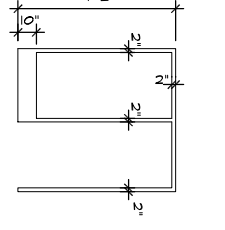
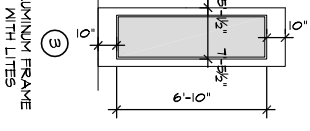
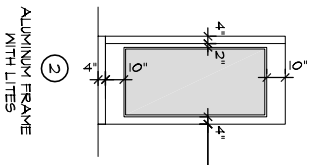
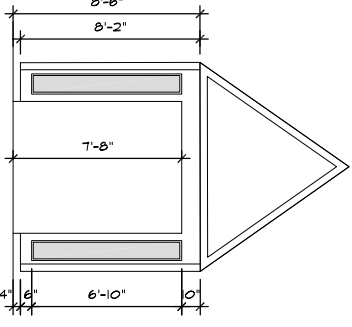

NOTE:  
 #4 PAINT ALL H.M. FRAMES

1 DOOR TYPES  
 1/4" x 1-0"

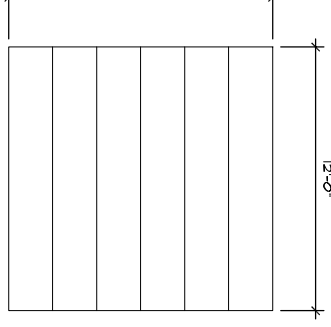
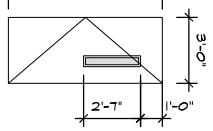
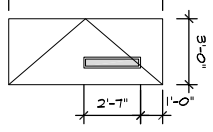
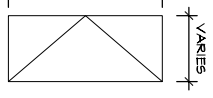
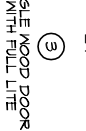
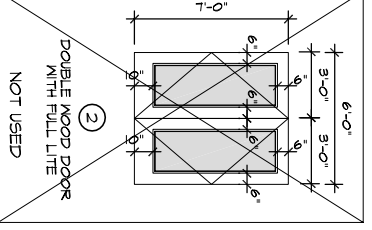
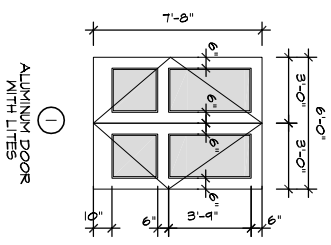

DOOR AND FRAME SCHEDULE

Number	DOOR			FRAME			FIRE RATING	HDMR TYPE	NOTES
	Type	MD	HGT	Type	HEAD	JAMB			
101	1	6-0	T-0	1	--	--	--	1	
102	6	3-0	T-0	5	7/A4.3	16/A4.3	--	2	STOREFRONT ASSEMBLY
103	1	3-0	T-0	5	5/A4.2	5/A4.2	--	3	STOREFRONT ASSEMBLY
105	4	3-0	T-0	5	5/A4.2	5/A4.2	--	1	2 HR PARTITION
106	5	3-0	T-0	5	5/A4.2	5/A4.2	--	7	
106.2	1	3-0	T-0	5	5/A4.2	5/A4.2	--	6	2 HR PARTITION
107	4	3-0	T-0	5	5/A4.2	5/A4.2	--	1	
108	4	3-0	T-0	5	5/A4.2	5/A4.2	--	5	
109	4	3-0	T-0	4	5/A4.2	5/A4.2	--	5	
110	3	3-0	T-0	4	5/A4.2	5/A4.2	--	1	
111	4	3-0	T-0	5	5/A4.2	5/A4.2	--	1	
112	4	3-0	T-0	5	5/A4.2	5/A4.2	--	1	
113	4	3-0	T-0	5	5/A4.2	5/A4.2	--	1	
114	4	3-0	T-0	5	5/A4.2	5/A4.2	--	1	
115	4	3-0	T-0	5	5/A4.2	5/A4.2	--	1	
116	4	3-0	T-0	5	5/A4.2	5/A4.2	--	1	
116.2	4	12-0	14-0	--	7/A4.3	516/A4.3	4/A4.3	3	
116.3	4	12-0	14-0	--	15/A4.3	14/A4.3	13/A4.3	3	
116.4	1	3-0	T-0	5	7/A4.3	516/A4.3	4/A4.3	3	
117	4	3-0	T-0	5	5/A4.2	5/A4.2	--	1	
117.2	4	3-0	T-0	5	5/A4.2	516/A4.3	4/A4.3	3	
117.3	4	3-0	T-0	5	5/A4.2	5/A4.2	--	1	
118	6	3-0	T-0	5	5/A4.2	5/A4.2	--	5	
119	6	3-0	T-0	5	5/A4.2	5/A4.2	--	5	
120	6	3-0	T-0	5	5/A4.2	5/A4.2	--	5	
121	6	3-0	T-0	5	5/A4.2	5/A4.2	--	4	
122	6	3-0	T-0	5	5/A4.2	5/A4.2	--	4	60 MIN
123	6	3-0	T-0	5	5/A4.2	5/A4.2	--	4	NOT USED
									1 HR PARTITION

- NOTES:
- COORDINATE SPECIFIC LABELING REQUIREMENTS FOR OPENINGS WITH APPLICABLE CODES
  - AND CONSTRUCTION OF DOOR AND FRAME ASSEMBLIES
  - ALL WOOD AND STEEL DOORS TO BE 1 3/4" THICK
  - SEE SPECIFICATION AND DETAILS FOR SILLS AND THRESHOLDS.
  - PAINT ALL H.M. FRAME P-2
  - ALL STEEL DOORS WITH CLOSERS TO RECEIVE KICK PLATES ON PUSH SIDE.
  - TYPE A - (DOOR WIDTH MINUS 1") x 10"
  - TYPE B - (DOOR WIDTH MINUS 1") x 30"

DELTA ROOFING  
 PORTLAND, MAINE

PDT ARCHITECTS  
 ARCHITECTURE  
 INTERIOR DESIGN  
 PLANNING  
 49 DARTMOUTH STREET  
 PORTLAND, ME 04103  
 207-755-1059  
 207-755-2694 FAX

COPYRIGHT 2006  
 PDT Architects  
 Review and reproduction of the  
 content of this document in the  
 position of PDT Architects.

JOB NO. 05-136  
 DRAWN: CHK. MEI.  
 SCALE: AS NOTED  
 ISSUE: CONSTRUCTION SET  
 ATG/STP 9, 2006  
 TITLE: DOOR TYPES WINDOW TYPES SCHEDULES  
 SHEET: A4.2