



PO Box 2551  
2257 West Broadway  
South Portland, ME 04106

1.800.370.3473  
fax 207.879.0540

www.norrisinc.com

Please fax this information to the Administrative Sales Assistant at the So. Portland Office at (207)-879-0540.

## Building Owner Information Form

Job Name:	Project #:
-----------	------------

Electrical Contractor:
------------------------

# NFPA requires this information for proper documentation

***\*The contractor MUST provide all of the information with an asterisk below before ANY equipment can be released.***

*If building owner contact is unknown provide contact name/tel. of GC and check box*

Electrical Contractor Contact Name:	
Estimated Date Equip. Needed:	*Estimated Finals Date:

*Building Owner:
------------------

*Job Site Address:
--------------------

*City:	State:	Zip:
--------	--------	------

*Contact Name:	Check here if GC
----------------	------------------

*Phone #:	Fax #:
-----------	--------



PO Box 2551  
2257 West Broadway  
South Portland, ME 04106

1.800.370.3473  
fax 207.879.0540

[www.norrisinc.com](http://www.norrisinc.com)

**Thank you for your cooperation.**

**Please advise the building owners that if this system is equipped with a digital communicator, then they MUST also make monitoring arrangements prior to a certificate of occupancy. Norris Inc. will attempt to contact the building owners**

---

# **STOP!**

**THIS COPY IS FOR YOUR ELECTRICIAN  
ON THE JOB-SITE**

**PLEASE BE SURE THIS COPY IS FORWARDED**

- 1) **A riser diagram is enclosed. DO NOT USE THE ENGINEER'S RISER SHOWN ON THE PLANS. If there is any information that you question, call us immediately.**
  - 2) **YOU MUST CALL AT LEAST FIVE DAYS IN ADVANCE TO SCHEDULE FINAL CONNECTION ASSISTANCE.**
  - 3) **All of your wires must be labeled and clear of any grounds, shorts or opens and must maintain polarity throughout. Meter out all circuits before calling for final connection assistance. If applicable verify End of Line resistors are in place.**
  - 4) **If using shielded cable, the drain wires must be connected and fully insulated (wrapped with tape) so that neither the shield or the drain wire touches the backbox.**
  - 5) **Unless special arrangements are made, we will make one final job-site visit. If a special visit is required for an elevator inspection or partial occupancy, then additional charges may apply if special arrangements were not made ahead. Call your customer service representative.**
  - 6) **If you have any defective or left-over parts DO NOT WRITE ON THEM OR THE BOXES. Save the original box, all mounting hardware and instructions. Returns that do not conform to this practice will not be accepted for credit.**
  - 7) **If the system is being monitored through a digital communicator, then please turn to page 2.**
-



PO Box 2551  
2257 West Broadway  
South Portland, ME 04106

1.800.370.3473  
fax 207.879.0540

[www.norrisinc.com](http://www.norrisinc.com)

## **IMPORTANT INFORMATION FOR THE BUILDING OWNERS SPECIAL NOTE REGARDING ALARM MONITORING SERVICES**

**Included within your alarm system package is a digital communicator, which sends a coded message to a private 24-hour central station if your alarm system is activated. This is a code requirement for most fire alarm systems. As a service to our customer, we offer central station monitoring services from our local UL Listed central station at extremely competitive rates.**

**If the central station monitoring contract is purchased through Norris Inc. prior to our scheduled start-up; we will connect, program, and test the communicator at no additional charge.**

**Should the building owners decide to obtain monitoring services from another company, then the cost for programming and testing the communicator will be the sole responsibility of the firm they have contracted with. Furthermore, if programming changes are made to the system by persons other than Norris Inc. technicians, then the company performing the changes shall be solely liable for any personal injury or loss of life or damage to or loss of property arising out of the use of or inability to use the system and it shall result in a waiver of any system warranties.**

**We appreciate that you understand the delicate nature of this life safety and/or security system and realize that serious problems may arise when modifications to the system are made including very simple programming changes.**

**Call Norris Inc. at 1-800-370-FIRE (3473) to make arrangements for central station monitoring services.**



PO Box 2551  
2257 West Broadway  
South Portland, ME 04106

1.800.370.3473  
fax 207.879.0540

[www.norrisinc.com](http://www.norrisinc.com)

# ***SUBMITTAL PACKAGE***

**Project: Allagash Brewing**

**System: Fire Alarm System**

**Submitted By: Norris Inc.  
2257 West Broadway  
South Portland, Maine 04106  
Telephone: (800) 370-3473**

**Electrical Contractor: Corey Electric, Inc.  
609 Main Street, STE 3  
Westbrook, ME. 04092**

**Date: November 7, 2012**

## Company Profile

*"We are extremely proud to represent the highest quality manufacturers integrating life safety, alarm and communication systems throughout northern New England."*

**-- Bradford Norris, President --**

## Mission Statement

Provide quality engineered systems, exceptional service.

## Goal

Learn...Continually Improve...Exceed Expectations

Founded in 1979 Norris Inc. has grown to become Northern New England's leading integrated system contracting and supply company. Norris Inc. is an innovated proactive organization with extensive experience in integration interdisciplinary building management systems. Our local and national affiliations assure that your project will be done properly regardless of size representing leading manufacturers our comprehensive products provide outstanding quality reliability and performance... surpassing customer application requirements and exceeding the stringent requirements of Underwriters Laboratories, National Fire Protection Association and other codes. We maintain an exceptional level of quality and provide the highest levels of customer service. Our knowledgeable technical support will insure the great service you deserve. Whether your needs involve industrial, commercial, institutional, or educational applications, you can trust that Norris Inc. has the complete resources it takes to provide the right solution right away.

---

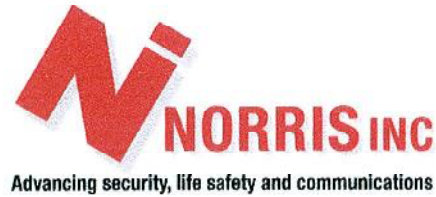

## **OUR CONTINUOUS COMMITMENT TO OUR ENVIRONMENT**

At Norris, Inc. we are proudly committed to continuous environmental improvement for a sustainable future and to develop strong partnerships within our community.

Our mission while running our operations is to do everything within our power to improve the environmental quality of our world and to work together to create a clean and safe place to live in and work in for future generations.

We will incorporate and promote green practices within our operations with policies to support it, a system of rewarding those that fully embrace it and then will regularly review our practices for continuous improvement.

We will establish policies, make investments in technologies and set the example in our own operations to include our ongoing commitment to go paperless and making it a requirement to Reuse, Reduce & Recycle, to turn off unneeded lights, to not allow our vehicles to idle, to encourage carpooling and to utilize practical energy efficient transportation.

We will always be 100% compliant with all applicable environmental laws and regulations and will report any violations.

We will remain committed to working locally and whenever possible to sell and use locally manufactured products.

We will insist that every purchase we make will include a review of its environmental impact with a very high priority to selecting the greenest products and services available.

We will remain committed to selling low energy products. This includes promoting wireless technologies, using existing wire infrastructures in our installations, promoting solar powered devices, using our Remote Services in lieu of on-site service calls and performing calculations to minimize power supply and battery needs.

We will educate our employees and customers to illustrate that green practices and purchases are almost always less costly in the long run.

We will support and give priority to organizations that show the strongest commitment to the environment.

We will actively encourage and promote the same responsible green practices that we utilize in the work place to our employees for use in their everyday personal lives.



PO Box 2551  
2257 West Broadway  
South Portland, ME 04106

1.800.370.3473  
fax 207.879.0540

[www.norrisinc.com](http://www.norrisinc.com)

## **LIMITED WARRANTY**

Norris, Inc. warrants that the products of its manufacturers shall be free from defects in materials or workmanship as warranted by the manufacturer which is typically for a one (1) year period from the completed installation date, but not always. The completed installation date will be the date when the end-user was able to begin using or started using the product(s) or the system, whether partially or in its entirety. For projects that have a specification or bid instructions to follow which contains specific warranty requirements, Norris Inc. will always honor the warranty terms exactly as specified in the project's specifications or bid documents, which may be more or less in coverage and duration than the manufacturer's warranty. In performing hundreds of projects per year with thousands of different products it is impossible for Norris, Inc. to track the terms and details of specified or individual product warranties. Therefore Norris, Inc. will request that the owner's representative provide these special warranty details when the warranty work is requested; otherwise a standard one year warranty on the equipment will be honored. The manufacturer's warranty is for equipment only and does not include any labor and/or shipping costs. All warranties provided by Norris, Inc. are limited with the same limitations included with the manufacturer's warranty which is included in the manuals of the products being provided.

The warranty will apply only if such goods have been properly installed, are subject to normal proper use and have not been modified in any manner whatsoever. Upon return of the defective product, Norris, Inc. will, at its sole discretion, either repair or replace, at no cost, such goods determined to have a defect in materials or workmanship. In cases of a warranty repair, Norris, Inc. will use its sole discretion to determine if a suitable replacement part can be provided on loan while the repairs are being performed.

All warranty work is performed during regular business hours. If emergency warranty work is required, the customer will pay the difference between the emergency service bill and our normal hourly charges.

Norris, Inc.'s limited warranty does not apply to those products that are damaged due to misuse, abuse, negligence, exposure to adverse environmental conditions, acts of God or have been modified in any manner whatsoever.

Norris, Inc.'s Standard terms and conditions are provided with our invoices. Those Terms and Conditions shall be provided upon request.

**NORRIS, INC. SHALL NOT UNDER ANY CIRCUMSTANCES BE LIABLE FOR ANY INCIDENTAL OR CONSEQUENTIAL DAMAGES ARISING FROM LOSS OF LIFE &/OR PROPERTY OR OTHER DAMAGE OR LOSSES OWING TO THE FAILURE OF NORRIS INC. PRODUCTS BEYOND THE COST OF REPAIR OR REPLACEMENT OF ANY DEFECTIVE PRODUCTS.**

**NORRIS, INC. MAKES NO WARRANTY OF FITNESS OR MERCHANTABILITY AND NO OTHER WARRANTY, ORAL OR WRITTEN, EXPRESS OR IMPLIED AS ALLOWED TO THE FULLEST EXTENT OF THE LAW.**





*NFPA recognizes*

NORRIS INC

*as a member in good standing, entitled  
to all rights and privileges of membership.*

  
James M. Shannon, *President*

January 22, 2003  
Date of Issue

NATIONAL SYSTEMS CONTRACTORS ASSOCIATION

# NSCA Membership Certificate

This is to certify that

**Norris Inc**

is an official member of the

**National Systems Contractors Association**

Your membership is valid through:

*January 2013*



**Ron Pusey**  
President



**Chuck Wilson**  
Executive Director



*This is to certify that*

**NORRIS, INC.**

*is an authorized Engineered Systems Distributor for NOTIFIER*

*During the year of 2012*

*J. J. Jomlerli*

*Signed for and on behalf of NOTIFIER*

*Vice President Domestic Sales*

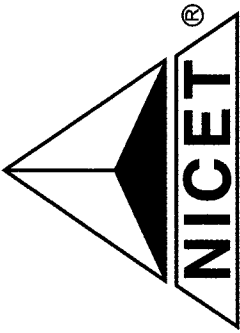

# NATIONAL INSTITUTE FOR CERTIFICATION IN ENGINEERING TECHNOLOGIES®

*Providing Certification Programs Since 1961*

BE IT KNOWN THAT

**David S. Gagnon**

IS HEREBY AWARDED CERTIFICATION AT

**LEVEL IV**

**IN FIRE PROTECTION ENGINEERING TECHNOLOGY  
FIRE ALARM SYSTEMS**

BASED UPON SUCCESSFUL DEMONSTRATION OF REQUISITE KNOWLEDGE,  
EXPERIENCE AND WORK PERFORMANCE AS SET FORTH BY THIS INSTITUTE.

Certification Valid through April 1, 2014

CERTIFICATION NUMBER 88203

CHAIRMAN OF THE NICET BOARD OF GOVERNORS

A DIVISION OF THE NATIONAL SOCIETY OF PROFESSIONAL ENGINEERS

**Norris Inc**

2257 West Broadway

South Portland, ME 04106

1-800-370-3473

**COREY ELECTRIC, INC.**

609 MAIN STREET, STE 3

WESTBROOK, ME 04092

**313068R1****Equipment List :**

Page: 1

COREYE 207-591-8151 Fax:207-591-8153

**Allagash Brewing Adds****Description**

NOTIFIER-NFW2-100, Addressable fire alarm control panel. Black  
ADI-IM-12120, 12 V 12AH Battery  
ADI-MO-804R2, MOD TO MOD 8C 2'RADIONICS CORD  
ADI-MO-RJ31X, SFS MT 8C RJ31X UL (917UL)  
NOTIFIER-NOT-BG12LX, Addressable Pull Station.  
NOTIFIER-NZM-100-6, 6-Input 2-Wire Det. Zone Module  
NOTIFIER-NMM-100P, Addressable Mini Module  
NOTIFIER-EOLR-1, 12 or 24 volt EOL relay module.  
NOTIFIER-BB-XP, Cabinet for two XP boards, surface mount.  
NOTIFIER-HSRC, Horn Strobe, Red, Ceiling, 2 wire, 12/24V, multi-candela  
NOTIFIER-HSR, Horn Strobe, Red, Wall, 2 wire, 12/24V, multi-candela  
NOTIFIER-STR, Strobe, Red, Wall, 2 wire, 12/24V, multi-candela  
NOTIFIER-FCPS-24S8, 8.0 amps, 120 VAC remote charger power supply.  
ADI-IM-1270, 12V 7AH Battery  
NOTIFIER-NP-100, Intelligent Addressable Photo detector, with base (over fcps)

SPAAGEELE-SSU00685, fire alarm record storage cabinet red  
SPAAGEELE-IE0091, Notifier Lock

# ➤ FireWarden-100-2(E) Rev 3

## Intelligent Addressable FACP



### Addressable Fire Alarm Control Panel

#### General

The Notifier FireWarden-100-2 Rev 3 (NFW2-100) with Version 5.0 firmware is a combination FACP (Fire Alarm Control Panel) and DACT (Digital Alarm Communicator/Transmitter) all on one circuit board. This compact intelligent addressable control panel has an extensive list of powerful features.

The SLC (Signaling Line Circuit) of the FireWarden-100-2 Rev 3 operates using a Rapid Group Polling communication protocol technology that polls multiple devices simultaneously for a quicker device response time. This patented technology allows a fully-loaded panel with up to 198 devices to report an incident and activate the notification circuits in under 10 seconds. With this improved polling, devices can be wired on standard twisted, unshielded wire up to a distance of 10,000 feet.

The 's quick-remove chassis protects the electronics during construction. The backbox can be installed allowing field wiring to be pulled. When construction is completed, the electronics can be quickly installed with just two bolts.

**New features for Rev 3 with Version 5.0 firmware** include removable terminal blocks, improved transient protection, additional secondary ANN-BUS, and increased power for the resettable and remote sync outputs.

Available accessories include ANN-BUS devices as well as ACS LED, graphic and LCD annunciators, and reverse polarity/city box transmitter.

The integral DACT transmits system status (alarms, supervisories, troubles, AC loss, etc.) to a Central Station via the public switched telephone network. It also allows remote and local programming of the control panel using the PS-Tools Upload/Download utility. In addition, the control panel may be programmed or interrogated off-site via the public switched telephone network. Any personal computer with Windows® XP or greater, a compatible modem, and PS-Tools—the Upload/Download software kit—may serve as a Service Terminal. This allows download of the entire program or upload of the entire program, history file, walktest data, current status and system voltages. The panel can also be programmed through the FACP's keypad or via a standard PS-2 computer keyboard, which can be plugged directly into the printed circuit board. This permits easy typing of address labels and other programming information.

Version 5.0 firmware supports the following: Primary and Secondary ANN-bus devices, NP-A100, USB port, NAC circuit diagnostics, a new report has been added to the walk-test that lists untested devices, new device types added: audio telephone type code for NFV-25/50ZST, Photo Supervisory and auto-resettable Drill (non-latching).

The FireWatch Series internet monitoring modules IPDACT-2 and IPDACT-2UD permit monitoring of alarm signals over the Internet saving the monthly cost of two dedicated business telephone lines. Although not required, the secondary telephone line may be retained providing backup communication over the public switched telephone line.

**NOTE:** Unless otherwise specified, the term "FireWarden-100-2" is used in this document to refer to both the FireWarden-100-2 and the FireWarden-100-2E FACP's (Fire Alarm Control Panels). Likewise, "NFW2-100" refers to NFW2-100E as well.

#### Features

- Listed to UL standard 864, 9th edition.
- On-board DACT.



- Remote site or local USB port upload/download, using PS-Tools.
- Four (4) Style Y (Class B) NAC circuits, which can be converted to four (4) Style Z (Class A) circuits with optional ZNAC-92 converter module. (Up to 6.0 amps total NAC power when using optional XRM-24B.)
- Selectable strobe synchronization for System Sensor, Wheelock, and Gentex devices.
- Remote Acknowledge, Silence, Reset and Drill via addressable monitor modules or FDU-80, N-ANN-80 or Legacy ACS Annunciators.
- ANN-BUS for connection to following optional modules (cannot be used if ACS annunciators are used):
  - N-ANN-80(-W) Remote LCD Annunciator
  - N-ANN-I/O LED Driver
  - N-ANN-S/PG Printer Module
  - N-ANN-RLY Relay Module
  - N-ANN-LED Annunciator Module
  - N-ANN-RLED Annunciator Module alarms only
  - ROME Relay Option Module Enclosure
- ACS & Terminal-mode Annunciators:
  - ACS Annunciators: Up to 32 Legacy ACM Series annunciators (ACM-16AT or ACM-32 series). Cannot be used if ANN-BUS devices are used.
  - Terminal-mode Annunciators: Up to 32 Legacy FDU-80 annunciators.
- EIA-232 printer/PC interface (variable baud rate) on main circuit board, for use with optional UL-listed printer PRN-6.
- Integral 80-character LCD display with backlighting.
- Real-time clock/calendar with automatic daylight savings control.
- Detector sensitivity test capability (NFPA 72 compliant).

- History file with 1,000-event capacity.
- Maintenance alert warns when smoke detector dust accumulation is excessive.
- Automatic device type-code verification.
- One person audible or silent walk test with walk-test log and printout.
- Point trouble identification.
- Waterflow (nonsilenceable) selection per monitor point.
- System alarm verification selection per detector point.
- PAS (Positive Alarm Sequence) and presignal delay per point (NFPA 72 compliant).

**NOTE:** Only detectors may participate in PAS.

#### **SLC LOOP:**

- SLC can be configured for NFPA Style 4, 6, or 7 operation.
- SLC supports up to 198 addressable devices per loop (99 detectors and 99 monitor, control, or relay modules).
- SLC loop maximum length 10,000 ft. (3,000 m.).  
*See installation manual for wire tables.*

#### **NOTIFICATION APPLIANCE CIRCUITS (NACS):**

- Four onboard NACs with additional NAC capability using output control modules (NC-100). The four Class B NACs can be converted to four Class A NACs with optional ZNAC-92 converter module.
- Silence Inhibit and Auto Silence timer options.
- Continuous, March Time, Temporal or California code for main circuit board NACs with two-stage capability.
- Selectable strobe synchronization per NAC.
- 2.5 amps maximum per each NAC circuit.

**NOTE:** Maximum 24VDC system power output is shared among all NAC circuits and 24VDC special-application auxiliary power outputs. Total available output is 3.0 amps. Using the optional XRM-24B transformer increases 24VDC output to 6.0 amps.

#### **PROGRAMMING AND SOFTWARE:**

- Autoprogram (learn mode) reduces installation time.
- Custom English labels (per point) may be manually entered or selected from an internal library file.
- Three Form-C relay outputs (two programmable).
- 99 software zones.
- Continuous fire protection during online programming at the front panel.
- Program Check automatically catches common errors not linked to any zone or input point.
- **OFFLINE PROGRAMMING:** Create the entire program in your office using a Windows®-based software package (NFW2-100 requires PS-Tools Programming software, available on [www.magni-fire.com](http://www.magni-fire.com)). Upload/download system programming locally to the NFW2-100 Rev 3 in less than one minute.
- USB upload/download programming with standard Male-A to Male-B cable.

## **User Interface**

#### **LED INDICATORS**

- AC Power (green)
- Fire Alarm (red)
- Supervisory (yellow)
- Alarm Silenced (yellow)
- System Trouble (yellow)
- Maintenance/Presignal (yellow)
- Disabled (yellow)
- Battery Fault (yellow)

- Ground Fault (yellow)

#### **KEYPAD CONTROLS**

- Acknowledge/Step
- Alarm Silence
- Drill
- System Reset (lamp test)
- 16-key alpha-numeric pad (similar to telephone keypad)
- 4 cursor keys
- Enter

## **Product Line Information**

**NFW2-100:** FireWarden-100-2 Rev 3 198-point addressable Fire Alarm Control Panel, one SLC loop. Includes 80-character LCD display, single printed circuit board mounted on chassis, and cabinet. 120 VAC operation.

**NFW2-100R:** Same as **NFW2-100**, except in a red backbox.

**NFW2-100E:** Same as **NFW2-100**, except with 240 VAC operation.

**4XTM Reverse Polarity Transmitter Module:** Provides supervised output for local energy municipal box transmitter, alarm, and trouble.

**ZNAC-92:** Optional converter module which converts four (4) Style Y (Class B) NAC circuits to four (4) Style Z (Class A) circuits.

**PS Tools:** Programming software for Windows®-based PC computer (cable not included), available on [www.firelite.com](http://www.firelite.com).

**DP-9692B:** Optional dress panel for FireWarden-100-2 Rev 3.

**TR-CE-B:** Optional trim Ring for semi-flush mounting.

**BB-26:** Battery backbox, holds up to two 26 AH batteries and CHG-75.

**NFS-LBB:** Battery box, houses two 55 AH batteries.

**CHG-75:** Battery charger for lead-acid batteries with a rating of 25 to 75 AH.

**CHG-120:** Remote battery charging system for lead-acid batteries with a rating of 55 to 120 AH. Requires additional NFS-LBB for mounting.

**NOTE:** CHG-120 or CHG-75 required for batteries larger than 18AH.

**BAT Series:** Batteries, see data sheet DN-6933.

**XRM-24B(E):** Optional transformer. Increases system power output to 6.0 amps. Use XRM-24BE with FireWarden-100-2E Rev 3.

**PRT/PK-CABLE:** Cable printer/personal computer interface cable; required for printer or for local upload/download programming and updating panel firmware.

**PRN-6:** UL listed compatible event printer. Uses tractor-fed paper.

**IPDACT-2/2UD, IPDACT Internet Monitoring Module:** Mounts in bottom of enclosure with optional mounting kit (PN IPBRKT). Connects to primary and secondary DACT telephone output ports for internet communications over customer provided ethernet internet connection. Requires compatible Teldat VisorALARM Central Station Receiver. Can use DHCP or static IP. (*See data sheet DN-60408 for more information.*)

**IPBRKT:** Mounting kit for IPDACT-2/2UD in common enclosure.

**IPSPLT:** Y-adaptor option allows connection of both panel dialer outputs to one IPDACT-2/2UD cable input.

#### **COMPATIBLE ANNUNCIATORS**

**N-ANN-80(-W):** LCD Annunciator is a remote LCD annunciator that mimics the information displayed on the FACP LCD display. Recommended wire type is un-shielded. (Basic model is black; order -W version for white; see DN-7114.)

**N-ANN-LED:** Annunciator Module provides three LEDs for each zone: Alarm, Trouble and Supervisory. Ships with red or black enclosure (see DN-60242).

**N-ANN-RLED:** Provides alarm (red) indicators for up to 30 input zones or addressable points. (See DN-60242).

**N-ANN-RLY:** Relay Module, which can be mounted inside the cabinet, provides 10 programmable Form-C relays. (See DN-7107.)

**ROME-B:** Relay Option Module Enclosure (order ROME-B for black or ROME for red). Provides one **N-ANN-RLY** Relay Module already installed. The ROME Series provides mounting space for one additional Relay Module or one addressable Multi-module. (See *Installation Sheet PN 53530*.)

**N-ANN-S/PG:** Serial/Parallel Printer Gateway module provides a connection for a serial or parallel printer. (See DN-7103.)

**N-ANN-I/O:** LED Driver Module provides connections to a user supplied graphic annunciator. (See DN-7105.)

**ACM-8R:** Relay module provides 8 Form-C 5.0 amp relays.

**ACM Annunciator Series:** LED-type fire annunciators capable of providing up to 99 software zones of annunciation. Available in increments of 16 or 32 points to meet a variety of applications.

**LDM Graphic Series:** Lamp Driver Module series for use with custom graphic annunciators.

**FDU-80 (Liquid Crystal Display) point annunciator:** 80-character, backlit LCD-type fire annunciators capable of displaying English-language text.

**NOTE:** For more information on Compatible Annunciators for use with the FireWarden-100-2 Rev 3, see the following data sheets (document numbers) ACM-8R (DN-3558), ACS/ACM Series (DN-0524), LDM Series (DN-0551), FDU-80 (DN-6820).

### COMPATIBLE ADDRESSABLE DEVICES

All feature a polling LED and rotary switches for addressing.

**NI-100:** Addressable low-profile ionization smoke detector.

**NP-100:** Addressable low-profile photoelectric smoke detector.

**NP-100T:** Addressable low-profile photoelectric smoke detector with thermal sensor.

**NP-100R:** Addressable remote test capable detector for use with DNR(W) duct smoke detector housings.

**NH-100:** Fast-response, low-profile heat detector.

**NH-100R:** Fast-response, low-profile heat detector with rate-of-rise option.

**NH-100H:** Fixed high-temperature detector that activates at 190F/88C.

**NP-A100:** Addressable low-profile multi-sensor detector.

**DNR:** Innovair Flex low-flow non-relay duct-detector housing. Order NP-100R separately.

**DNRW:** Innovair Flex low-flow non-relay duct-detector housing, with NEMA-4 rating. Watertight. (Order NP-100R separately.)

**NMM-100:** Addressable Monitor Module for one zone of normally-open dry-contact initiating devices. Mounts in standard 4.0" (10.16 cm.) box. Includes plastic cover plate and end-of-line resistor. Module may be configured for either a Style B (Class B) or Style D (Class A) IDC.

**NDM-100:** Dual Monitor Module. Same as NMM-100 except it provides two Style B (Class B) only IDCs.

**NMM-100P:** Miniature version of NMM-100. Excludes LED and Style D option. Connects with wire pigtailed. May mount in device backbox.

**NZM-100:** Similar to NMM-100, but may monitor up to 20 conventional two-wire detectors. Requires resettable 24 VDC power. Consult factory for compatible smoke detectors.

**NC-100:** Addressable Control Module for one Style Y/Z (Class B/A) zone of supervised polarized Notification Appliances. Mounts directly to a 4.0" (10.16 cm.) electrical box. Notification

Appliance Circuit option requires external 24 VDC to power notification appliances.

**NC-100R:** Addressable relay module containing two isolated sets of Form-C contacts, which operate as a DPDT switch. Mounts directly to a 4.0" (10.16 cm.) box, surface mount using the SMB500.

**NOT-BG12LX:** Addressable manual pull station with interface module mounted inside.

**N100-ISO:** Fault Isolator Module. This module isolates the SLC loop from short circuit conditions (required for Style 6 or 7 operation).

**SMB500:** Used to mount all modules except the NMM-100P.

**NMM-100-10:** Ten-input monitor module. Mount one or two modules in a BB-XP cabinet (optional). Mount up to six modules on a CHS-6 chassis in a BB-25.

**NZM-100-6:** Six-zone interface module for compatible conventional two-wire detectors. Mount one or two modules in a BB-XP cabinet (optional). Mount up to six modules on a CHS-6 chassis in a BB-25.

**NOTE:** For more information on Compatible Addressable Devices for use with the FireWarden-100-2 Rev 3, see the following data sheets (document numbers): N100-ISO (DN-6994), NP-100 series (DN-6995), NI-100 (DN-6996), NH-100 series (DN-6997), ND-100 series (DN-7006), NP-A100 (DN-6998), NMM-100/NMM-100P/NDM-100/NZM-100 (DN-6999), NC-100/NC-100R (DN-7000), NOT-BG12LX (DN-7001), NMM-100-10 (DN-6990), and NZM-100-6 (DN-60150).

### Wiring Requirements

While shielded wire is not required, it is recommended that all SLC wiring be twisted-pair to minimize the effects of electrical interference. Wire size should be no smaller than 18 AWG (0.78 mm<sup>2</sup>) and no larger than 12 AWG (3.1 mm<sup>2</sup>). The wire size depends on the length of the SLC circuit. Refer to the panel manual for wiring details.



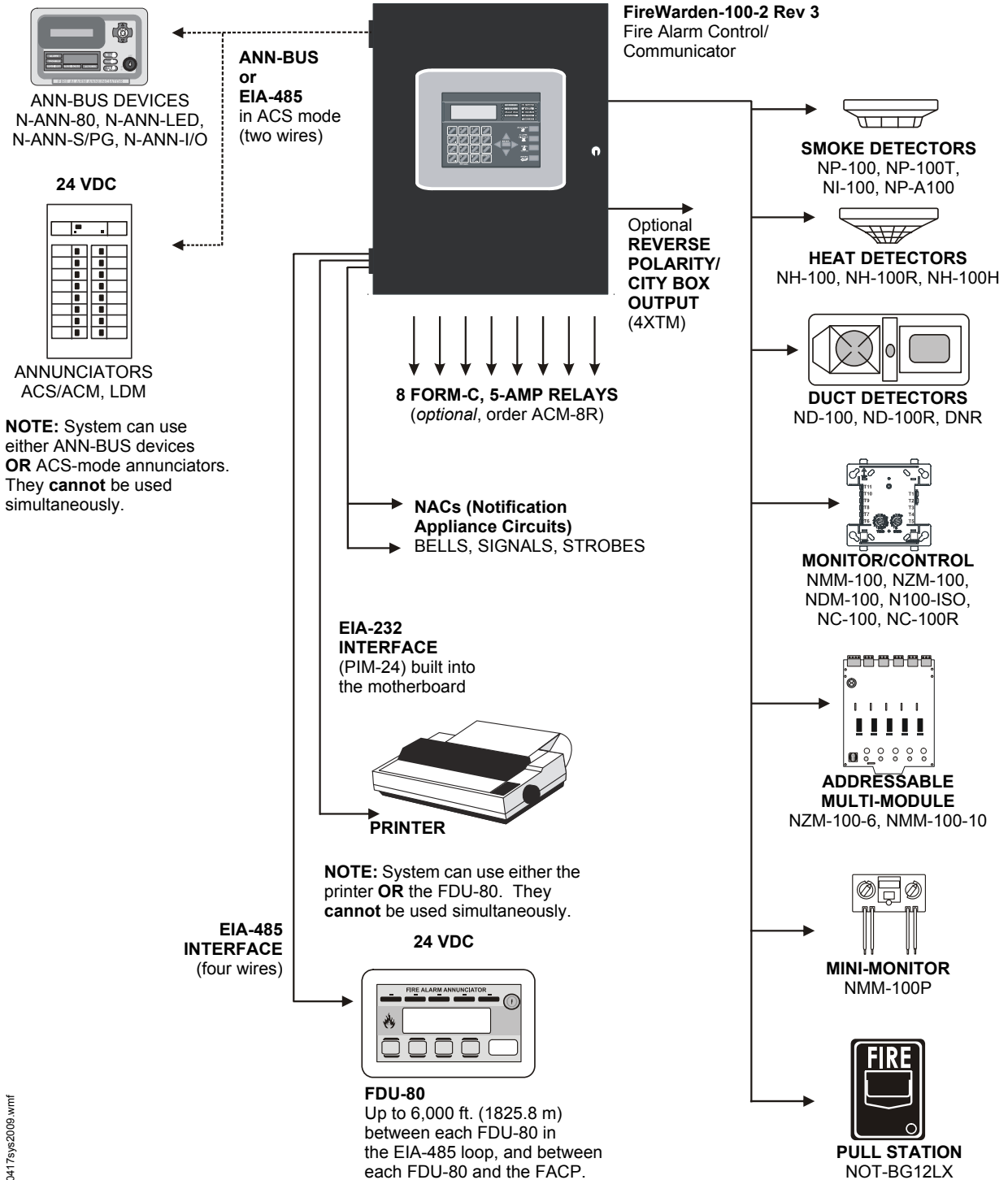

60417sys2009.wmf



# SYSTEM SPECIFICATIONS

## System Capacity

• Intelligent Signalling Line Circuits.....	1
• Addressable device capacity .....	198
• Programmable software zones .....	99
• ACS Annunciators .....	32
• ANN-bus devices .....	16

## Electrical Specifications

**AC Power:** FireWarden-100-2 Rev 3: 120 VAC, 60 Hz, 3.0 amps. FireWarden-100-2 Rev 3(E): 240 VAC, 50 Hz, 1.5 amps. Wire size: minimum 14 AWG (2.00 mm<sup>2</sup>) with 600 V insulation.

**Battery charger capacity:** 7 AH - 18 AH batteries. Up to two 18 Ah batteries can be housed in the FACP cabinet. Larger batteries require an external battery charger such as the CHG-75 or CHG-120, and a separate battery cabinet such as the BB-26 or NFS-LBB.

**Communication Loop:** Supervised and power-limited.

**Notification Appliance Circuits:** Each terminal block provides connections for two Style Y (Class B) for a total of four Style Y (Class B) or with an optional ZNAC-92 module converts to four Style Z (Class A) NACs. Maximum signaling current per circuit: 2.5 amps. End-of-Line Resistor: 4.7K ohm, 1/2 watt (P/N 71252 UL listed) for Style Y (Class B) NAC. Refer to panel documentation and *Notifier Device Compatibility Document* for listed compatible devices.

**Two Programmable Relays and One Fixed Trouble Relay:** Contact rating: 2.0 amps @ 30 VDC (resistive), 0.5 amps @ 30 VAC (resistive). Form-C relays.

**Special Application Non-resettable Power (24 VDC Nominal):** Jumper selectable (JP4) for conversion to resettable power output. Up to 1.0 amp total DC current available from each output. Power-limited.

**Special Application Resettable Power (24 VDC nominal):** Jumper selectable (JP6) for conversion to non-resettable power. Up to 1.0 amp total DC current available. Refer to the *Notifier Device Compatibility Document* for listed compatible devices.

**Remote Sync Output:** Remote power supply synchronization output. Nominal special application power: 24 VDC. Maximum current: 300 mA. End-of-Line Resistor: 4.7K ohm. Output linked to NAC 1 control. Supervised and power-limited.

**Telephone Interface:** Unless used with Teldat VISORALARM, requires dedicated business telephone number with a minimum of 5 volts DC (off-hook voltage). Obtain dedicated phone line directly from your local phone company. Do not use shared phone lines or PBX (digital) type phone line extensions.

## Cabinet Specifications

**Door:** 19.26" (48.92 cm.) high x 16.82" (42.73 cm.) wide x 0.12" (.30 cm.) deep. **Backbox:** 19.00" (48.26 cm.) high x 16.65"

(42.29 cm.) wide x 5.20" (13.34 cm.) deep. **Trim Ring (TR-CE-B):** 22.00" (55.88 cm.) high x 19.65" (49.91 cm.) wide.

## Shipping Specifications

**Weight:** 26.9 lbs. (12.20 kg.) **Dimensions:** 20.00" (50.80 cm.) high x 22.5" (57.15 cm.) wide x 8.5" (21.59 cm.) deep.

## Temperature and Humidity Ranges

This system meets NFPA requirements for operation at 0 – 49°C/32 – 120°F and at a relative humidity 93% ± 2% RH (non-condensing) at 32°C ± 2°C (90°F ± 3°F). However, the useful life of the system's standby batteries and the electronic components may be adversely affected by extreme temperature ranges and humidity. Therefore, it is recommended that this system and its peripherals be installed in an environment with a normal room temperature of 15 – 27°C/60 – 80°F.

## NFPA Standards

The FireWarden-100-2 Rev 3 complies with the following NFPA 72 Fire Alarm Systems requirements:

- **LOCAL** (Automatic, Manual, Waterflow and Sprinkler Supervisory).
- **AUXILIARY** (Automatic, Manual and Waterflow) (requires 4XTM).
- **REMOTE STATION** (Automatic, Manual, Waterflow and Sprinkler Supervisory) (Where a DACT is not accepted, the alarm, trouble and supervisory relays may be connected to UL 864 listed transmitters. For reverse polarity signaling of alarm and trouble, 4XTM is required.)
- **PROPRIETARY** (Automatic, Manual, Waterflow and Sprinkler Supervisory).
- **CENTRAL STATION** (Automatic, Manual, Waterflow and Sprinkler Supervisory).
- **OT, PSDN** (Other Technologies, Packet-switched Data Network)

## Agency Listings and Approvals

The listings and approvals below apply to the basic FireWarden-100-2 Rev 3 control panel. In some cases, certain modules may not be listed by certain approval agencies, or listing may be in process. Consult factory for latest listing status.

- **UL Listed:** S635
- **FM approved**
- **CSFM:** 7165-0028:0235
- **MEA:** 120-06-E, Volume 2

For ULC-listed version, see DN-60600.

NOTIFIER® is a registered trademark of Honeywell International Inc. Wheelock® is a registered trademark of and Exceder™ is a trademark of Cooper Notification.

©2010 by Honeywell International Inc. All rights reserved. Unauthorized use of this document is strictly prohibited.



This document is not intended to be used for installation purposes. We try to keep our product information up-to-date and accurate. We cannot cover all specific applications or anticipate all requirements. All specifications are subject to change without notice.



Made in the U.S. A.

# ➤ BAT Series Batteries

## Sealed Lead-Acid or Gell Cell

**Power Supplies**

### General

**BAT Series Batteries** feature a new part-numbering/listing system — providing an improved method of delivery for NOTIFIER-approved sealed lead-acid batteries for all your fire alarm system needs. Multiple brands of batteries are now offered under generic part numbers, reducing backorder situations and permitting us to deliver these products in a more timely fashion. NOTIFIER has approved the multiple brands listed below as possible product shipped for a given part number. Please note that any incoming orders for “PS Series” batteries will be converted to the equivalent BAT Series part numbers.



6933cov.jpg

### Features

- Provide secondary power for control panels.
- Sealed and maintenance-free.
- Overcharge protected.
- Easy handling with leakproof construction.
- Ruggedly constructed, high-impact case (ABS, polystyrene, or polypropylene, depending on models).
- Long service life.
- Compact design.

### Agency Listings and Approvals

The listings and approvals below apply to BAT Series Batteries. In some cases, certain modules may not be listed by certain approval agencies, or listing may be in process. Consult factory for latest listing status.

- **UL Recognized Components:** files MH19884 (*B & B Battery*), MH20567 (*UPG, previously Jolt*), MH20845 (*Power-Sonic*).

### Part Number Reference

CURRENT Part Number	BATTERY DESCRIPTION	ALTERNATES APPROVED: manufacturers and P/Ns shipped under BAT P/Ns
BAT-1250	12 V, 5 AH, sealed.	BP5-12 (B&B Battery); PS-1250 (Power-Sonic); SA1250 (Jolt) to be replaced with UB1250 (UPG).
BAT-1250	12 V, 5 AH, sealed.	BP5-12 (B&B Battery); PS-1250 (Power-Sonic); SA1250 (Jolt) to be replaced with UB1250 (UPG).
➤ BAT-1270	12 V, 7 AH, sealed.	BP7-12 (B&B Battery); PS-1270 (Power-Sonic); SA1272 (Jolt) to be replaced with UB1270 (UPG).
➤ BAT-12120	12 V, 12 AH, sealed.	BP12-12 (B&B Battery); PS-12120 (Power-Sonic); SA12120 (Jolt) to be replaced with UB12120 (UPG).
BAT-12180	12 V, 18 AH, sealed.	PS-12180 (Power-Sonic); SA12180 (Jolt) to be replaced with UB12180 (UPG).
BAT-12180	12 V, 18 AH, sealed.	PS-12180 (Power-Sonic); SA12180 (Jolt) to be replaced with UB12180 (UPG).
BAT-12260	12 V, 26 AH, sealed.	BP26-12 (B&B Battery); PS-12260 (Power-Sonic); SA12260 (Jolt) to be replaced with UB12260 (UPG).
BAT-12550	12 V, 55 AH, sealed.	PS-12550 (Power-Sonic); XSA12550 (Jolt) to be replaced with UB12550 (UPG).
BAT-12550	12 V, 55 AH, sealed.	PS-12550 (Power-Sonic); XSA12550 (Jolt) to be replaced with UB12550 (UPG).
BAT-121000	12 V, 100 AH, gell cell.	PS-121000 (Power-Sonic); XSA121000A (Jolt) to be replaced with UB121000 (UPG).

# POWER-SONIC

## Part Number Reference

1109t1.tbl

MODEL	Nominal Voltage V	Nominal Capacity @ 20 hr. rate A.H.	Discharge Current @20 hr. rate mA	DIMENSIONS									
				Width		Depth		Height		Height over terminal		Weight	
				in.	mm	in.	mm	in.	mm	in.	mm	lb.	kg.
PS-1250	12	5	250	3.54	90	2.76	70	4.02	102	4.21	107	4.1	1.9
PS-1270	12	7	325	5.94	151	2.56	65	3.7	94	3.86	98	5.7	2.6
PS-12120	12	12	600	5.94	151	3.86	98	3.7	94	3.86	98	8.8	4
PS-12180	12	18	875	7.13	181	2.99	76	6.57	167	6.57	167	12.8	5.8
PS-12250	12	25	1300	6.89	175	6.54	166	4.92	125	4.92	125	18.7	8.5
PS-12550	12	55	3000	10.25	260	6.6	168	8.2	208	9.45	240	39.7	18
PS-121000	12	100	5000	12	305	6.6	168	8.2	208	9.45	240	65.7	29.8

**Characteristic Discharge Curves**

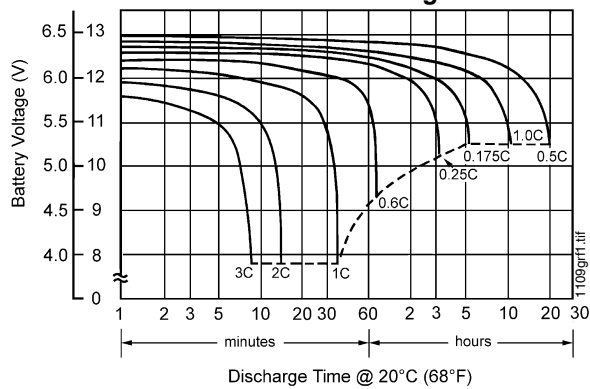

**Effect of Temperature on Capacity**

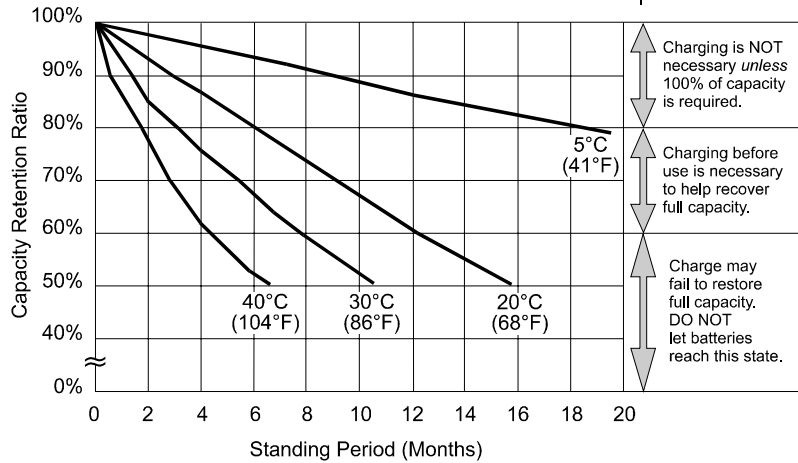
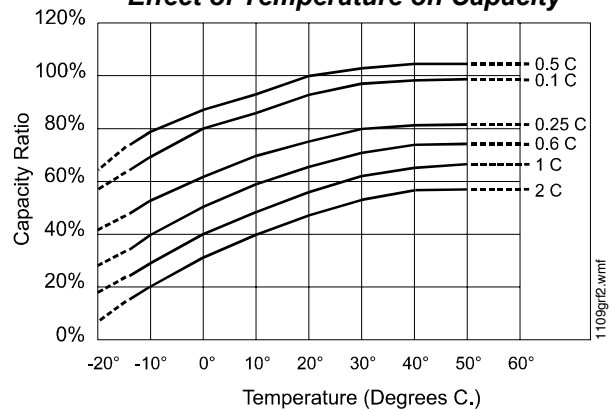

**at left:  
PS-121000  
Shelf-Life  
and Storage**

Charging is NOT necessary unless 100% of capacity is required.

Charging before use is necessary to help recover full capacity.

Charge may fail to restore full capacity. DO NOT let batteries reach this state.

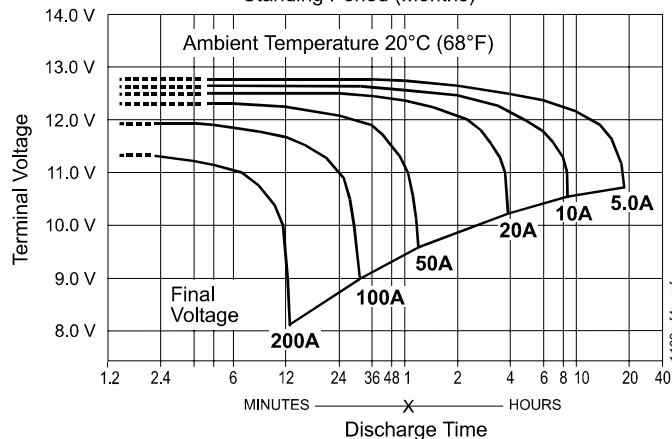

**at left:  
PS-121000  
Discharge  
Characteristics**

## B & B BATTERY

Model	V	Nominal Capacity (AH)				Weight		Terminal				Dimensions							
								Standard		Optional		L		W		H		TH	
		20 hr	10 hr	5 hr	1 hr	kg	lbs	Type	Pos.	Type	Pos.	mm	in	mm	in	mm	in	mm	in
BP5-12	12	5.00	4.75	4.25	3.00	1.86	4.10	T1	3	T2		90	3.54	70	2.76	102	4.02	106	4.17
BP7-12	12	7.00	6.65	5.95	4.20	2.60	5.73	T2	5	T1		151	5.94	65	2.56	93	3.66	98	3.86
BP12-12	12	12.00	11.40	10.20	7.20	4.03	8.89	B1	5	T1		151	5.94	98	3.86	94	3.70	98	3.86
BP26-12	12	26.00	24.70	22.10	15.60	9.40	20.73	B1	7	T2.11	9	175	6.89	166	6.54	125	4.92	125	4.92

### Charging Procedure

Application	Charging method	Charging voltage at 20°C (V/cell)	Temperature compensation coefficient of charging voltage (mV/°C/cell)	Maximum charging current (CA)	Charging time 0.1 CA, 20°C (h)		Temp (°C)
					100% discharge	50% discharge	
For standby power source	Constant voltage and constant current charging (with current restriction)	2.25 ~ 2.30	- 3	0.3	24	20	0 - 40°C (32 ~ 104°F)
For cycle service		2.40 ~ 2.50	- 4	0.3	16	10	

Temperature compensation of charging voltage is not needed when using the batteries within 5°C to 35°C range.

Final Voltage	Discharge Time: for Model BP5-12								
	5 min	10 min	15 min	30 min	1 hr	3 hr	5 hr	10 hr	20 hr
	Battery Output Power (W): for Model BP5-12								
10.80 V	180.8	133.1	106.6	63.5	36.39	14.57	10.05	5.62	2.94
10.50 V	209.2	144.2	111.5	65.9	37.48	14.87	10.20	5.70	3.00
10.20 V	222.3	149.4	115.0	67.4	38.16	15.00	10.26	5.73	3.01
9.90 V	232.3	152.9	117.6	68.3	38.61	15.10	10.29	5.75	3.02
9.60 V	240.0	156.0	120.0	69.0	39.0	15.20	10.32	5.75	3.02

**Constant Power Discharge Characteristics at 25°C/77°F for BP5-12**

Final Voltage	Discharge Time: for Model BP7-12								
	5 min	10 min	15 min	30 min	1 hr	3 hr	5 hr	10 hr	20 hr
	Battery Output Power (W): for Model BP7-12								
10.80 V	253.1	186.3	149.3	88.8	50.95	20.40	14.07	7.86	4.11
10.50 V	292.9	201.8	156.2	92.2	52.47	20.81	14.28	7.98	4.20
10.20 V	311.2	209.1	161.0	94.3	53.42	21.00	14.36	8.02	4.22
9.90 V	325.2	214.1	164.7	95.6	54.06	21.15	14.41	8.04	4.23
9.60 V	336.0	218.4	168.0	96.6	54.60	21.27	14.45	8.04	4.23

**Constant Power Discharge Characteristics at 25°C/77°F for BP7-12**

Final Voltage	Discharge Time: for Model BP12-12								
	5 min	10 min	15 min	30 min	1 hr	3 hr	5 hr	10 hr	20 hr
	Battery Output Power (W): for Model BP12-12								
10.80 V	433.9	319.4	256.0	152.3	87.34	34.98	24.12	13.48	7.05
10.50 V	502.2	346.0	267.7	158.1	89.96	35.68	24.48	13.68	7.20
10.20 V	533.6	358.5	276.0	161.7	91.57	36.00	24.61	13.75	7.23
9.90 V	557.5	367.1	282.4	164.0	92.67	36.25	24.70	13.79	7.25
9.60 V	576.0	374.4	288.0	165.6	93.60	36.47	24.77	13.79	7.25

**Constant Power Discharge Characteristics at 25°C/77°F for BP12-12**

Final Voltage	Discharge Time: for Model BP26-12								
	5 min	10 min	15 min	30 min	1 hr	3 hr	5 hr	10 hr	20 hr
	Battery Output Power (W): for Model BP26-12								
10.80 V	940.0	692.0	554.6	330.0	189.23	75.79	52.25	29.20	15.26
10.50 V	1088.0	749.7	580.0	342.5	194.91	77.30	53.04	29.64	15.60
10.20 V	1156.0	776.7	598.0	350.3	198.41	78.00	53.33	29.79	15.67
9.90 V	1208.0	795.3	611.8	355.2	200.79	78.54	53.52	29.88	15.71
9.60 V	1248.0	811.2	624.0	358.8	202.80	79.01	53.68	29.88	15.71

**Constant Power Discharge Characteristics at 25°C/77°F for BP26-12**

# B & B BATTERY

**BP5-12 Battery Discharge Characteristics (25°C/77°F)**

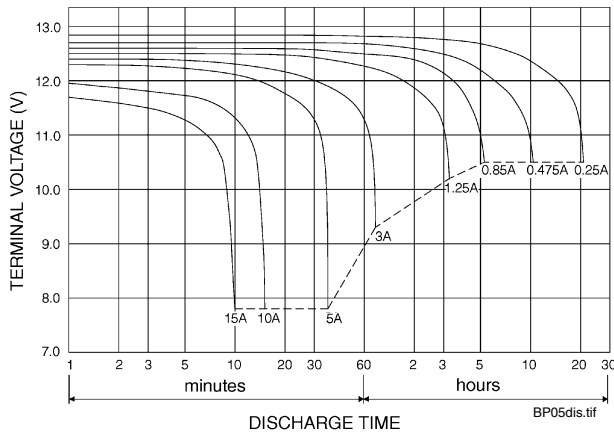

**BP7-12 Battery Discharge Characteristics (25°C/77°F)**

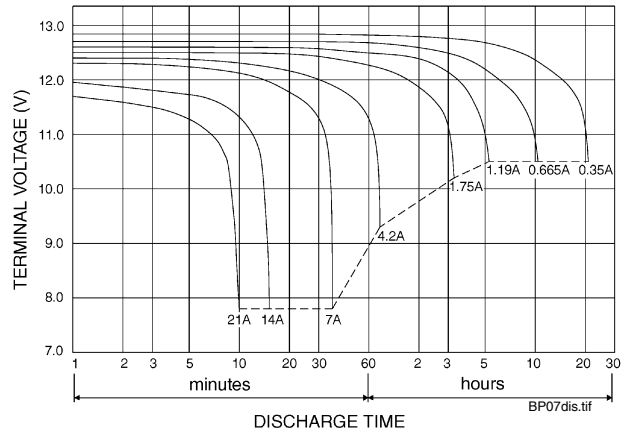

**BP12-12 Battery Discharge Characteristics (25°C/77°F)**

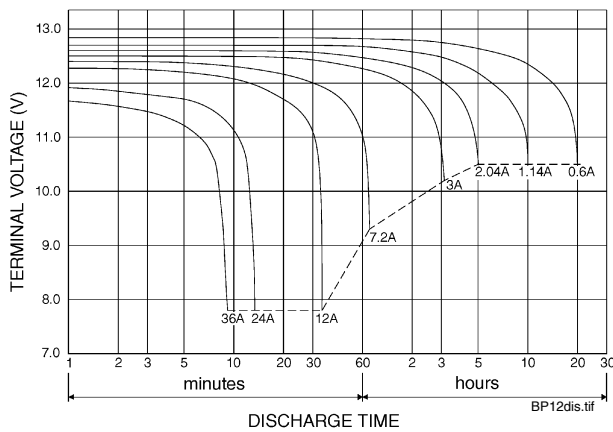

**BP26-12 Battery Discharge Characteristics (25°C/77°F)**

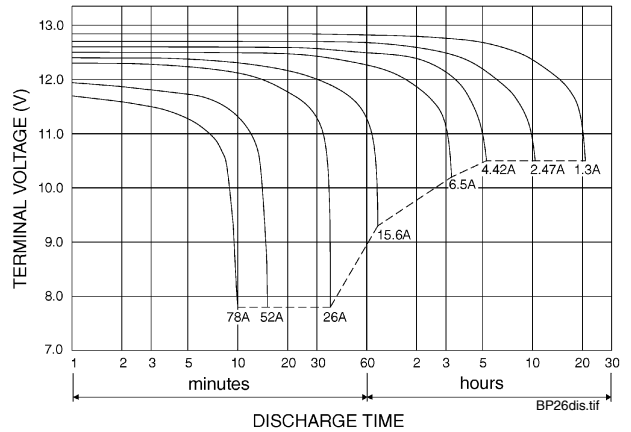

**BP05-12**



**BP12-12**



**BP26-12**



# UPG BATTERY

UB1250 has the same specifications as previous Jolt SA1250; SA1272 to be replaced with UB1270 (specs/diagrams pending).

## UB1250 (previously SA1250) Diagrams

UB1250/SA1250 discharge current vs. time

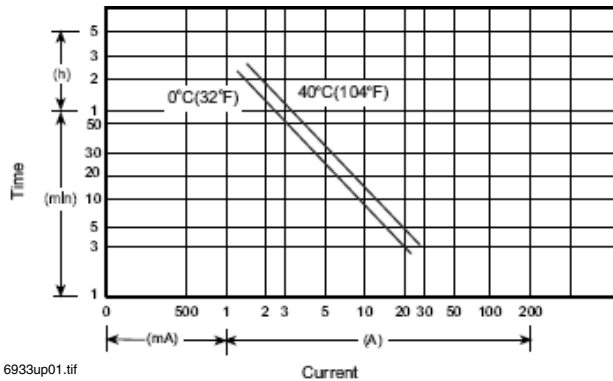

6933up01.tif

UB1250/SA1250 discharge characteristics (25°C/77°F)

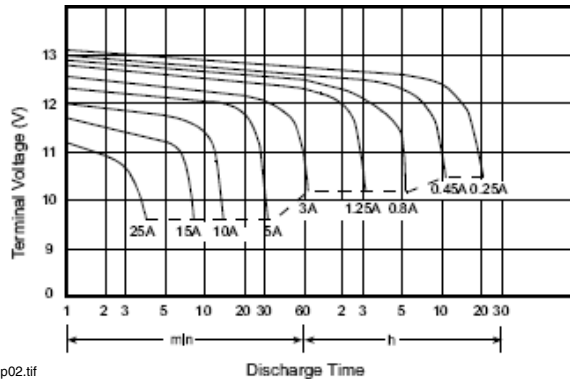

6933up02.tif

## UB1250, SA1250 Specifications

- Nominal voltage: 12 V.
- Nominal capacity (20 hr): 5.0 AH.
- Dimensions: total height 107 mm (4.21"); container height 101 mm (3.98"); length 90 mm (3.54"); width 70 mm (2.76").
- Weight: approximately 1.83 kg (4.03 lbs).
- Container material: UL94HB ABS, UL94V-0 ABS.
- Internal resistance (25°C, 77°F): ~ 32 m.
- Discharge capacity under different temperatures:
  - 40°C: ~ 102%
  - 25°C: ~ 100%
  - 0°C: ~ 85%
- Capacity 25°C/77°F:
  - 20 hr @ 0.25 A: 5.0 AH.
  - 5 hr @ 0.8 A: 4.0 AH.
  - 1 hr @ 3.0 A: 3.0 AH.
  - 1 C @ 5.0 A: 2.5 AH.
- Charging voltage (25°C, 77°F):
  - Standby use: 13.65 V ± 0.15 V.
  - Cycle use: 14.7 V ± 0.3 V.
- Maximum discharge current: 60 A (5 sec).
- Maximum charging current: 1.5 A.
- Self-discharge residual capacity (25°C, 77°F):
  - After 3 months: ~ 90%.
  - After 6 months: ~ 82%.
  - After 12 months: ~ 70%.

## SA1272 Diagrams

SA1272 discharge current vs. time

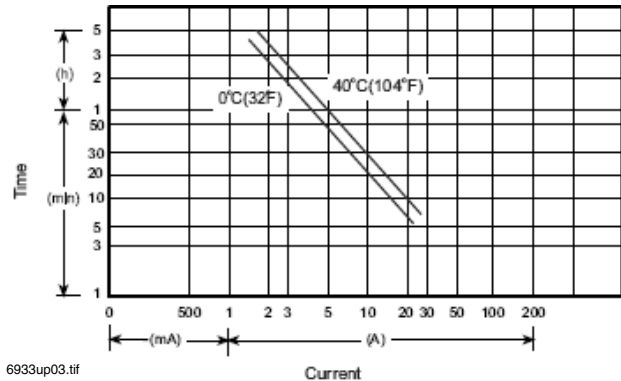

6933up03.tif

SA1272 discharge characteristics (25°C/77°F)

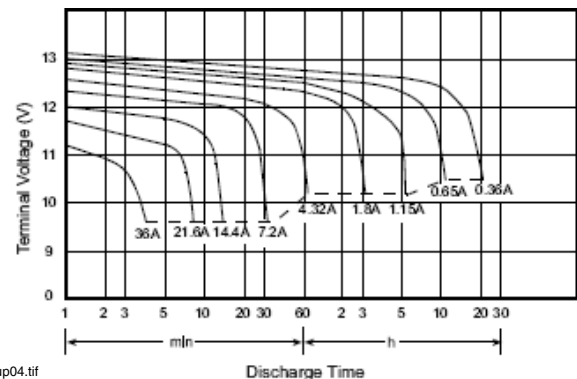

6933up04.tif

## SA1272 Specifications

- Nominal voltage: 12 V.
- Nominal capacity (20 hr): 7.2 AH.
- Dimensions: total height 100 mm (3.94"); container height 94 mm (3.70"); length 151 mm (5.95"); width 65 mm (2.56").
- Weight: approximately 2.66 kg (5.85 lbs).
- Container material: UL94HB ABS, UL94V-0 ABS.
- Internal resistance (25°C, 77°F): ~ 22 m.
- Discharge capacity under different temperatures:
  - 40°C: ~ 102%
  - 25°C: ~ 100%
  - 0°C: ~ 85%
- Capacity 25°C/77°F:
  - 20 hr @ 0.36 A: 7.2 AH.
  - 5 hr @ 1.15 A: 5.76 AH.
  - 1 hr @ 4.32 A: 4.32 AH.
  - 1 C @ 7.2 A: 3.6 AH.
- Charging voltage (25°C, 77°F):
  - Standby use: 13.65 V ± 0.15 V.
  - Cycle use: 14.7 V ± 0.3 V.
- Maximum discharge current: 90 A (5 sec).
- Maximum charging current: 2.16 A.
- Self-discharge residual capacity (25°C, 77°F):
  - After 3 months: ~ 90%.
  - After 6 months: ~ 82%.
  - After 12 months: ~ 70%.



# UPG BATTERY

Same specifications as previous Jolt models; packaging and part numbers are the only changes.

## UB12120 (was SA12120) Diagrams

UB12120/SA12120 discharge current vs. time

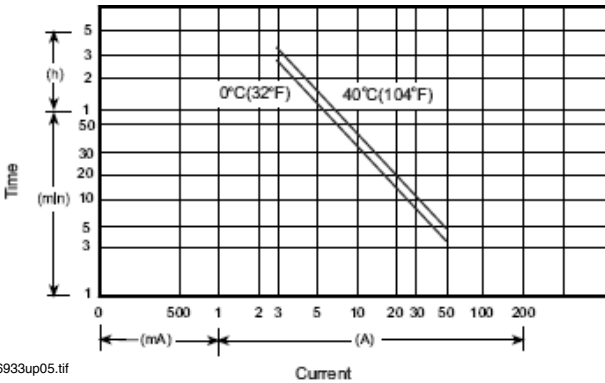

6933up05.tif

UB12120/SA12120 discharge characteristics (25°C/77°F)

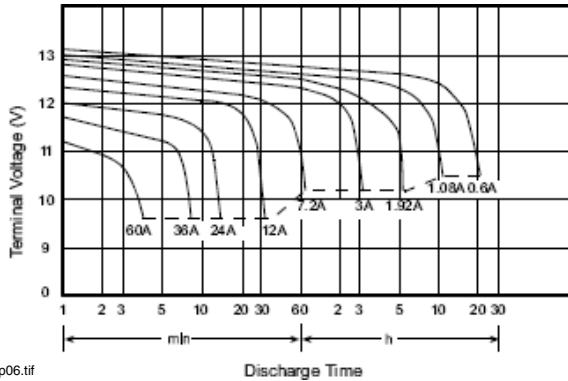

6933up06.tif

## UB12120, SA12120 Specifications

- Nominal voltage: 12 V.
  - Nominal capacity (20 hr): 12.0 AH.
  - Dimensions: total height 100 mm (3.94"); container height 94 mm (3.70"); length 151 mm (5.95"); width 98 mm (3.86").
  - Weight: approximately 4.10 kg (9.04 lbs).
  - Container material: UL94HB ABS, UL94V-0 ABS.
  - Internal resistance (25°C, 77°F): ~ 14 m.
  - Discharge capacity under different temperatures:
    - 40°C: ~ 102%
    - 25°C: ~ 100%
    - 0°C: ~ 85%
  - Capacity 25°C/77°F:
    - 20 hr @ 0.6 A: 12.0 AH.
    - 5 hr @ 1.92 A: 9.6 AH.
    - 1 hr @ 7.2 A: 7.2 AH.
    - 1 C @ 12.0 A: 6.0 AH.
  - Charging voltage (25°C, 77°F):
    - Standby use: 13.65 V ± 0.15 V.
    - Cycle use: 14.7 V ± 0.3 V.
- Maximum discharge current: 120 A (5 sec).  
 Maximum charging current: 3.6 A.  
 Self-discharge residual capacity (25°C, 77°F):  
 After 3 months: ~ 90%.  
 After 6 months: ~ 82%.  
 After 12 months: ~ 70%.

## UB12180 (was SA12180) Diagrams

UB12180/SA12180 discharge current vs. time

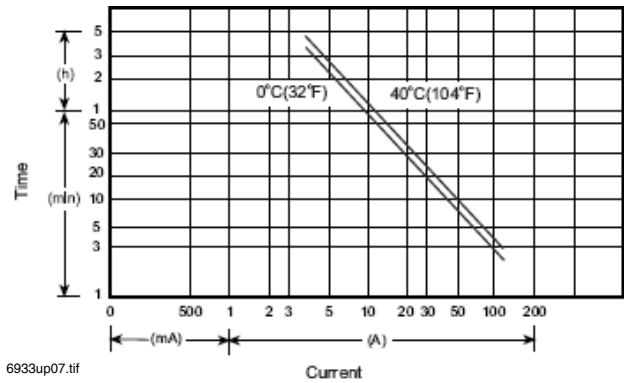

6933up07.tif

UB12180/SA12180 discharge characteristics (25°C/77°F)

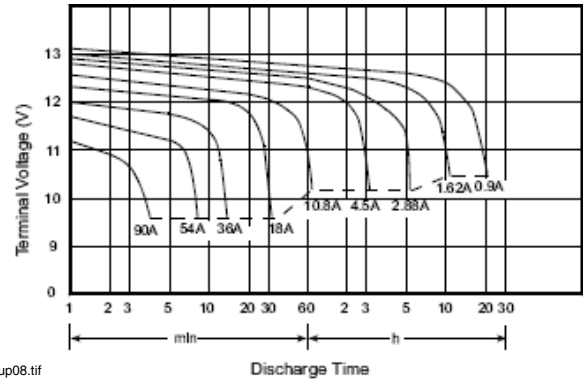

6933up08.tif

## UB12180, SA12180 Specifications

- Nominal voltage: 12 V.
  - Nominal capacity (20 hr): 18.0 AH.
  - Dimensions: total height 167 mm (6.58"); container height 167 mm (6.58"); length 181 mm (7.13"); width 76 mm (2.99").
  - Weight: approximately 6.06 kg (13.36 lbs).
  - Container material: UL94HB ABS, UL94V-0 ABS.
  - Internal resistance (25°C, 77°F): ~ 13 m.
  - Discharge capacity under different temperatures:
    - 40°C: ~ 102%
    - 25°C: ~ 100%
    - 0°C: ~ 85%
  - Capacity 25°C/77°F:
    - 20 hr @ 0.9 A: 18.0 AH.
    - 5 hr @ 2.88 A: 14.4 AH.
    - 1 hr @ 10.8 A: 10.8 AH.
    - 1 C @ 18.0 A: 9.0 AH.
  - Charging voltage (25°C, 77°F):
    - Standby use: 13.65 V ± 0.15 V.
    - Cycle use: 14.7 V ± 0.3 V.
- Maximum discharge current: 300 A (5 sec).  
 Maximum charging current: 5.4 A.  
 Self-discharge residual capacity (25°C, 77°F):  
 After 3 months: ~ 90%.  
 After 6 months: ~ 82%.  
 After 12 months: ~ 70%.

# UPG BATTERY

Same specifications as previous Jolt models; packaging and part numbers are the only changes.

## UB12260 (was SA12260) Diagrams

UB12260/SA12260 discharge current vs. time

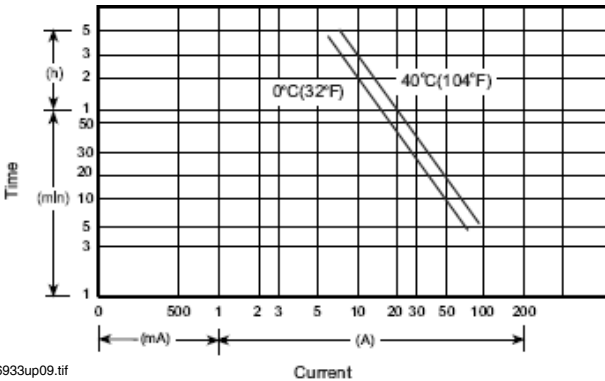

6933up09.tif

UB12260/SA12260 discharge characteristics (25°C/77°F)

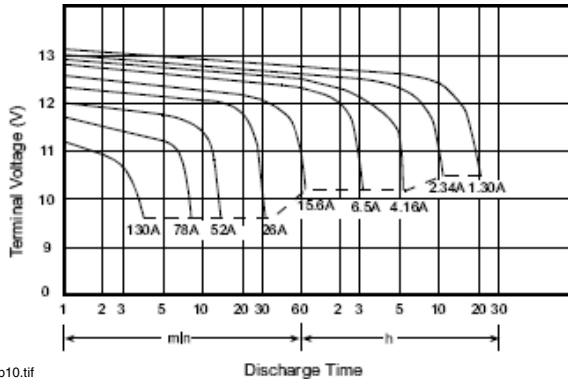

6933up10.tif

## UB12260, SA12260 Specifications

- Nominal voltage: 12 V.
- Nominal capacity (20 hr): 26.0 AH.
- Dimensions: total height 125 mm (4.92"); container height 125 mm (4.92"); length 166 mm (6.54"); width 175 mm (6.89").
- Weight: approximately 8.80 kg (19.40 lbs).
- Container material: UL94HB ABS, UL94V-0 ABS.
- Internal resistance (25°C, 77°F): ~ 10 m.
- Discharge capacity under different temperatures:
  - 40°C: ~ 102%
  - 25°C: ~ 100%
  - 0°C: ~ 85%
- Capacity 25°C/77°F:
  - 20 hr @ 1.3 A: 26.0 AH.
  - 5 hr @ 4.16 A: 20.8 AH.
  - 1 hr @ 15.6 A: 15.6 AH.
  - 1 C @ 26.0 A: 13.0 AH.
- Charging voltage (25°C, 77°F):
  - Standby use: 13.65 V ± 0.15 V.
  - Cycle use: 14.7 V ± 0.3 V.
- Maximum discharge current: 300 A (5 sec).
- Maximum charging current: 7.8 A.
- Self-discharge residual capacity (25°C, 77°F):
  - After 3 months: ~ 90%.
  - After 6 months: ~ 82%.
  - After 12 months: ~ 70%.

## UB12550 (was SA12550) Diagrams

UB12550/SA12550 discharge current vs. time

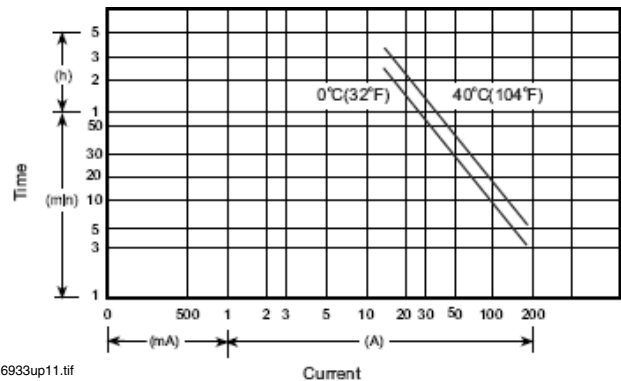

6933up11.tif

UB12550/SA12550 discharge characteristics (25°C/77°F)

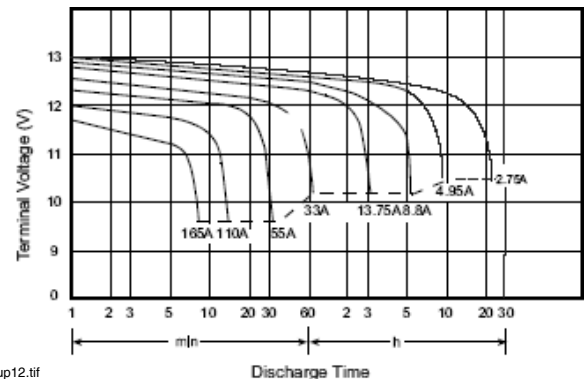

6933up12.tif

## UB12550, SA12550 Specifications

- Nominal voltage: 12 V.
- Nominal capacity (20 hr): 55.0 AH.
- Dimensions: total height 234.5 mm (9.23"); container height 216.5 mm (8.52"); length 229 mm (9.02"); width 138 mm (5.43").
- Weight: approximately 19.0 kg (41.8 lbs).
- Container material: UL94HB ABS, UL94V-0 ABS.
- Internal resistance (25°C, 77°F): ~ 8 m.
- Discharge capacity under different temperatures:
  - 40°C: ~ 102%
  - 25°C: ~ 100%
  - 0°C: ~ 85%
- Capacity 25°C/77°F:
  - 20 hr @ 2.75 A: 55.0 AH.
  - 5 hr @ 8.8 A: 44.0 AH.
  - 1 hr @ 33.0 A: 33.0 AH.
  - 1 C @ 55.0 A: 27.5 AH.
- Charging voltage (25°C, 77°F):
  - Standby use: 13.65 V ± 0.15 V.
  - Cycle use: 14.7 V ± 0.3 V.
- Maximum discharge current: 600 A (5 sec).
- Maximum charging current: 16.5 A.
- Self-discharge residual capacity (25°C, 77°F):
  - After 3 months: ~ 90%.
  - After 6 months: ~ 82%.
  - After 12 months: ~ 70%.

# UPG BATTERY

Same specifications as previous Jolt models; packaging and part numbers are the only changes.

## UB121000 (XSA121000A) Diagrams

UB121000/XSA121000A discharge current vs. time

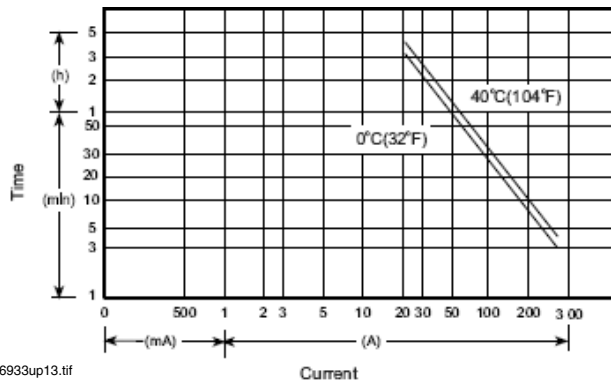

6933up13.tif

UB121000/XSA121000A discharge characteristics (25°C/77°F)

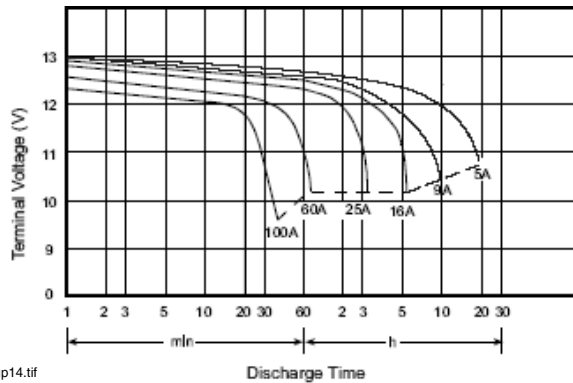

6933up14.tif

## UB121000 (XSA121000A) Diagrams

- Nominal voltage: 12 V.
- Nominal capacity (20 hr): 100.0 AH.
- Dimensions: total height 221 mm (8.70"); container height 214 mm (8.43"); length 329 mm (12.95"); width 172 mm (6.77").
- Weight: approximately 34.00 kg (74.8 lbs).
- Container material: UL94HB ABS, UL94V-0 ABS.
- Internal resistance (25°C, 77°F): ~ 6.5 m.
- Discharge capacity under different temperatures:
  - 40°C: ~ 102%
  - 25°C: ~ 100%
  - 0°C: ~ 85%
- Capacity 25°C/77°F:
  - 20 hr @ 5.0 A: 100.0 AH.
  - 5 hr @ 16.0 A: 80.0 AH.
  - 1 hr @ 60.0 A: 60.0 AH.
  - 1 C @ 100.0 A: 50.0 AH.
- Charging voltage (25°C, 77°F):
  - Standby use: 13.65 V ± 0.15 V.
  - Cycle use: 14.7 V ± 0.3 V.
- Maximum discharge current: 600 A (5 sec).
- Maximum charging current: 30 A.
- Self-discharge residual capacity (25°C, 77°F):
  - After 3 months: ~ 90%.
  - After 6 months: ~ 82%.
  - After 12 months: ~ 70%.

## UPG Summary Diagrams

Summary discharge characteristics

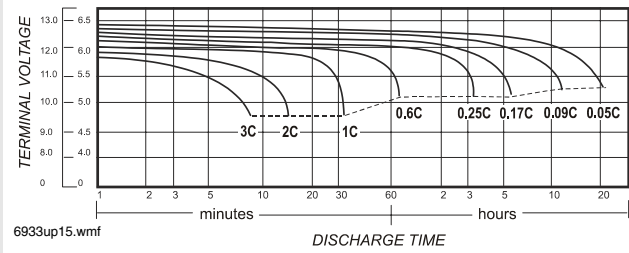

Summary discharge current vs. time curve (25°C/77°F)

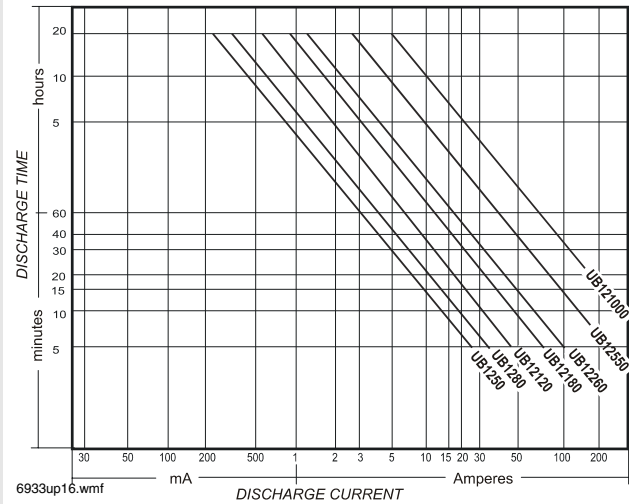

6933up16.wmf



6933ub1280.jpg



6933ub12260.jpg

# UPG BATTERY

Same specifications as previous Jolt models;  
packaging and part numbers are the only changes.

## Charging Procedure: UPG Battery

Application	Charging method	Charging voltage at 25°C (V/cell)	Temperature compensation coefficient of charging voltage (mV/°C/cell)	Maximum charging current (CA)	Charging time 0.1 CA, 25°C (h)		Temp (°C)
					100% discharge	50% discharge	
For standby power source	Constant voltage and constant current charging (with current restriction)	2.25 ~ 2.30	- 3.3 (-1.8 mV/°F/cell)	0.3	T <sup>3</sup> 24	T <sup>3</sup> 20	0 – 40°C (32 – 104°F)
For cycle service		2.40 ~ 2.50	- 5 (-2.8 mV/°F/cell)	0.3	16 < T < 24	10 < T < 24	

Temperature compensation of charging voltage is not needed when using the batteries within 5°C to 35°C range.

---

**NOTIFIER®** is a registered trademark of Honeywell International Inc.  
Batteries display trademarks of the manufacturer.  
©2009 by Honeywell International Inc. All rights reserved. Unauthorized use  
of this document is strictly prohibited.

---



---

This document is not intended to be used for installation purposes.  
We try to keep our product information up-to-date and accurate.  
We cannot cover all specific applications or anticipate all requirements.  
All specifications are subject to change without notice.

---

# NOT-BG12LX

## Addressable Manual Pull Station For FireWarden Series Panels



Intelligent/Addressable Devices

### General

The Notifier NOT-BG12LX is a state-of-the-art, dual-action (i.e., requires two motions to activate the station) pull station that includes an addressable interface for FireWarden series intelligent control panels, and the NSP-25 panel. Because the NOT-BG12LX is addressable, the control panel can display the exact location of the activated manual station. This leads fire personnel quickly to the location of the alarm.

### Features

- Maintenance personnel can open station for inspection and address setting without causing an alarm condition.
- Built-in bicolor LED, which is visible through the handle of the station, flashes in normal operation and latches steady red when in alarm.
- Handle latches in down position and the word “ACTIVATED” appears to clearly indicate the station has been operated.
- Captive screw terminals wire-ready for easy connection to SLC loop (accepts up to 12 AWG/3.25 mm<sup>2</sup> wire).
- Can be surface mounted (with SB-10 or SB-I/O) or semi-flush mounted. Semi-flush mount to a standard single-gang, double-gang, or 4" (10.16 cm) square electrical box.
- Smooth dual-action design.
- Meets ADAAG controls and operating mechanisms guidelines (Section 4.1.3[13]); meets ADA requirement for 5 lb. maximum activation force.
- Highly visible.
- Attractive shape and textured finish.
- Key reset.
- Includes Braille text on station handle.
- Optional trim ring (BG12TR).
- Meets UL 38, Standard for Manually Actuated Signaling Boxes.

### Construction

Shell, door, and handle are molded of durable polycarbonate material with a textured finish.

### Specifications

- **Shipping Weight:** 9.6 oz. (272.15 g)
- **Normal operating voltage:** 24 VDC.
- **Maximum SLC loop voltage:** 28.0 VDC.
- **Maximum SLC loop current:**  $\mu$ A.
- **Temperature Range:** 32°F to 120°F (0°C to 49°C)
- **Relative Humidity:** 10% to 93% (noncondensing)
- **For use indoors in a dry location**

### Installation

The NOT-BG12LX will mount semi-flush into a single-gang, double-gang, or standard 4" (10.16 cm) square electrical outlet box, or will surface mount to the model SB-10 or SB-I/O surface backbox. If the NOT-BG12LX is being semi-flush mounted, then the optional trim ring (BG12TR) may be used.



The NOT-BG12LX  
Addressable Manual Pull Station

The BG12TR is usually needed for semi-flush mounting with 4" (10.16 cm) or double-gang boxes (not with single-gang boxes).

### Operation

Pushing in, then pulling down on the handle causes it to latch in the down/activated position. Once latched, the word “ACTIVATED” (in bright yellow) appears at the top of the handle, while a portion of the handle protrudes from the bottom of the station. To reset the station, simply unlock the station with the key and pull the door open. This action resets the handle; closing the door automatically resets the switch.

Each manual station, on command from the control panel, sends data to the panel representing the state of the manual switch. Two rotary decimal switches allow address settings (1 – 99 on NFW2-100/NFW2-100C, 1 – 50 for NFW-50/NFW-50C).

### Architectural/Engineering Specifications

Manual Fire Alarm Stations shall be non-coded, with a key-operated reset lock in order that they may be tested, and so designed that after actual Emergency Operation, they cannot be restored to normal except by use of a key. An operated station shall automatically condition itself so as to be visually detected as activated. Manual stations shall be constructed of red-colored polycarbonate material with clearly visible operating instructions provided on the cover. The word FIRE shall appear on the front of the stations in white letters, 1.00 inches (2.54 cm) or larger. Stations shall be suitable for surface mounting on matching backbox SB-10 or SB-I/O; or semi-flush mounting on a standard single-gang, double-gang, or 4" (10.16 cm) square electrical box, and shall be installed within

the limits defined by the Americans with Disabilities Act (ADA) or per national/local requirements. Manual Stations shall be Underwriters Laboratories listed.

Manual stations shall connect with two wires to one of the control panel SLC loops. The manual station shall, on command from the control panel, send data to the panel representing the state of the manual switch. Manual stations shall provide address setting by use of rotary decimal switches.

### Product Line Information

**NOT-BG12LX:** Dual-action addressable pull station. Includes key locking feature.

**NOT-BG12LXA:** *Canadian* Dual-action addressable pull station. Includes key locking feature.

**SB-10:** Surface backbox; metal.

**SB-I/O:** Surface backbox; plastic.

**BG12TR:** Optional trim ring.

**17021:** Keys, set of two.

### Agency Listings and Approvals

In some cases, certain modules or applications may not be listed by certain approval agencies, or listing may be in process. Consult factory for latest listing status.

- **UL Listed:** S692 (listed for Canadian and non-Canadian applications)
- **MEA:** 67-02-E Vol. IV
- **CSFM:** 7150-0028:0199
- **FDNY:**
- **FM Approved**

**Patented:** U.S. Patent No. D428,351; 6,380,846; 6,314,772; 6,632,108.

---

Notifier® is a registered trademark of Honeywell International Inc.  
©2010 by Honeywell International Inc. All rights reserved. Unauthorized use of this document is strictly prohibited.

---



This document is not intended to be used for installation purposes.  
We try to keep our product information up-to-date and accurate.  
We cannot cover all specific applications or anticipate all requirements.  
All specifications are subject to change without notice.



Made in the U.S. A.

# ➤ NZM-100-6(A)

## Six Zone Interface Module for FireWarden Series Addressable Panels



Intelligent Addressable Devices

### General

NOTIFIER's FireWarden series **NZM-100-6 six-zone interface module** provides an interface between the intelligent alarm system and a two-wire conventional detection zone. A common SLC input is used for all modules, and the initiating device circuits share a common external supervisory supply and ground. Otherwise, each module operates independently from the others.

The first module is addressed from 01 to 94 while the remaining modules are automatically assigned to the next five higher addresses. Provisions are included for disabling a maximum of two unused modules. All two-wire detectors being monitored must be two-wire-compatibility-listed with the modules. The NZM-100-6 transmits the status of a zone of two-wire detectors to the fire alarm control panel. Status conditions are reported as normal, open, or alarm. The interface module supervises the zone of detectors and the connection of the external power supply.

Each NZM-100-6 module has panel-controlled bicolor LED indicators. The panel can cause the LEDs to blink, latch on, or latch off.

### Features

- Six addressable Class B or three addressable Class A initiating device circuits.
- Removable 12 AWG (3.1 mm<sup>2</sup>) to 18 AWG (0.78 mm<sup>2</sup>) plug-in terminal blocks.
- Status indicators for each point.
- Unused addresses may be disabled.
- Rotary address switches.
- Class A or Class B operation.
- Mount one or two modules in a BB-XP cabinet (optional).
- Mount up to six modules on a CHS-6 chassis in a CAB-3 Series, CAB-4 Series, or BB-25 cabinet (optional).
- Mounting hardware included.

### Specifications

**Standby current:** 2.0 mA (SLC current draw with all addresses used; if some addresses are disabled, the standby current decreases).

**Alarm current:** 40 mA (assumes all six LEDs solid ON).

**Temperature range:** 32°F to 120°F (0°C to 49°C).

**Humidity:** 10% to 85% noncondensing.

**Dimensions:** 6.8" (172.72 mm) high x 5.8" (147.32 mm) wide x 1.25" (31.75 mm) deep.

**Shipping weight:** 1.1 lb. (0.499 kg) including packaging.

**Mounting options:** CHS-6 chassis, BB-XP cabinet, BB-25 cabinet, CAB-3 Series cabinet (see DN-3549) or CAB-4 series ((see DN-6857) cabinet).

**Wire gauge:** 12 AWG (3.1 mm<sup>2</sup>) to 18 AWG (0.78 mm<sup>2</sup>).

**NZM-100-6 is shipped in Class B position:** Remove shunt for Class A operation.

**Maximum SLC wiring resistance:** 40 or 50 ohms, panel dependent.

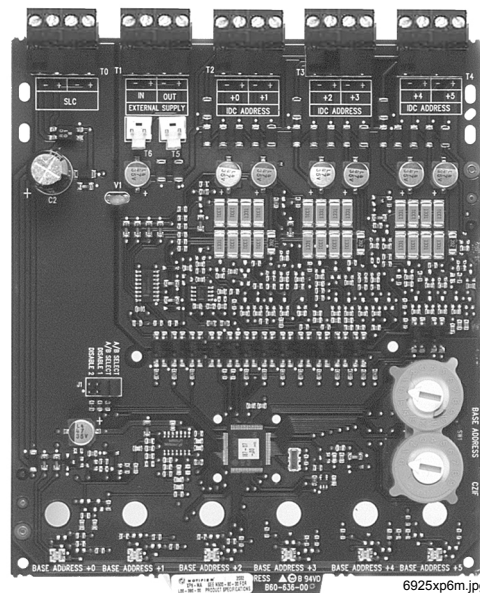

6925xp6m.jpg

**Maximum IDC wiring resistance:** 25 ohms.

**External supply voltage: DC voltage:** 18 – 28 volts power-limited. Ripple voltage: 0.1 Vrms maximum. External supply current: 90 mA maximum per address in alarm. In Class B operation, 540 mA maximum for all six addresses in alarm. In Class A operation, 270 mA maximum for all three addresses in alarm.

**Compatible detectors:** See the *Device Compatibility* document. Contact Notifier.

### Agency Listings and Approvals

These listings and approvals apply to the modules specified in this document. In some cases, certain modules or applications may not be listed by certain approval agencies, or listing may be in process. Consult factory for latest listing status.

- **UL Listed:** S635
- **ULC Listed:** S635 (NZM-100-6A)
- **MEA Listed:** 72-01-E Vol. 3
- **FM Approved**
- **CSFM:** 7300-0028:230

### Product Line Information

➤ **NZM-100-6:** Six-zone conventional-detector interface module.

**NZM-100-6A:** Same as above with ULC Listing.

**BB-XP:** Optional cabinet for one or two modules. Dimensions, DOOR: 9.234" (23.454 cm) wide (9.484" [24.089 cm] including hinges), x 12.218" (31.0337 cm) high, x 0.672" (1.7068 cm) deep; BACKBOX: 9.0" (22.860 cm) wide (9.25" [23.495 cm] including hinges), x 12.0" (30.480 cm) high x 2.75" (6.985 cm); CHASSIS (installed): 7.150" (18.161 cm) wide overall x 7.312"



(18.5725 cm) high interior overall x 2.156" (5.4762 cm) deep overall.

**BB-25:** Optional cabinet for up to six modules mounted on CHS-6 chassis (below). Dimensions, DOOR: 24.0" (60.96 cm) wide x 12.632" (32.0852 cm) high, x 1.25" (3.175 cm) deep, hinged at bottom; BACKBOX: 24.0" (60.96 cm) wide x 12.550" (31.877 cm) high x 5.218" (13.2537 cm) deep.

**CHS-6:** Chassis, mounts up to six modules in a BB-25, CAB-3 Series (see DN-3549) or CAB-4 Series (see DN-6857) cabinet.

---

**Notifier®** and **FireWarden®** are registered trademarks of Honeywell International Inc.  
©2009. All rights reserved. Unauthorized use of this document is strictly prohibited.



This document is not intended to be used for installation purposes.  
We try to keep our product information up-to-date and accurate.  
We cannot cover all specific applications or anticipate all requirements.  
All specifications are subject to change without notice.



Made in the U.S. A.

# Monitor Modules

## ➤ NMM-100(A), NMM-100P(A), NZM-100(A), and NDM-100(A) for FireWarden Series Panels



Intelligent Addressable Devices

### General

Four different monitor modules are available for Notifier's FireWarden Series intelligent control panels for a variety of applications. Monitor modules supervise a circuit of dry-contact input devices, such as conventional heat detectors and pull stations, or monitor and power a circuit of two-wire smoke detectors (NZM-100(A)).

**NMM-100(A)** is a standard-sized module (typically mounts to a 4" [10.16 cm] square box) that supervises either a Style D (Class A) or Style B (Class B) circuit of dry-contact input devices.

➤ **NMM-100P(A)** is a miniature monitor module a mere 1.3" (3.302 cm) H x 2.75" (6.985 cm) W x 0.5" (1.270 cm) D that supervises a Style B (Class B) circuit of dry-contact input devices. Its compact design allows the NMM-100P(A) to often be mounted in a single-gang box behind the device it monitors.

**NZM-100(A)** is a standard-sized module that monitors and supervises compatible two-wire, 24 volt, smoke detectors on a Style D (Class A) or Style B (Class B) circuit.

**NDM-100(A)** is a standard-sized dual monitor module that monitors and supervises two independent two-wire Style B (Class B) dry-contact initiating device circuits (IDCs) at two separate, consecutive addresses in intelligent, two-wire systems.

### NMM-100(A) Monitor Module

- Built-in type identification automatically identifies this device as a monitor module to the control panel.
- Powered directly by two-wire SLC loop. No additional power required.
- High noise (EMF/RFI) immunity.
- SEMS screws with clamping plates for ease of wiring.
- Direct Decade entry of address: 01 – 99 on FireWarden-100-2, 01 – 50 on FireWarden-50.
- LED flashes during normal operation and latches on steady to indicate alarm.

The NMM-100(A) Monitor Module is intended for use in intelligent, two-wire systems, where the individual address of each module is selected using the built-in rotary switches. It provides either a two-wire or four-wire fault-tolerant Initiating Device Circuit (IDC) for normally-open-contact fire alarm and supervisory devices. The module has a panel-controlled LED indicator.

### NMM-100(A) APPLICATIONS

Use to monitor a zone of four-wire smoke detectors, manual fire alarm pull stations, waterflow devices, or other normally-open dry-contact alarm activation devices. May also be used to monitor normally-open supervisory devices with special supervisory indication at the control panel. Monitored circuit may be wired as an NFPA Style B (Class B) or Style D (Class A) Initiating Device Circuit. A 47K ohm End-of-Line Resistor (provided) terminates the Style B circuit. No resistor is required for supervision of the Style D circuit.

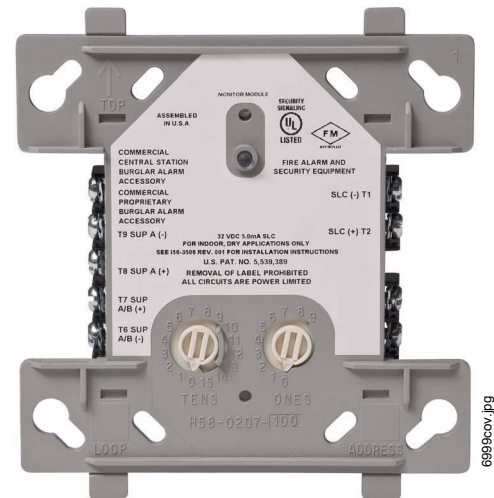

NMM-100(A) (Type H)

### NMM-100(A) OPERATION

Each NMM-100(A) uses one of the available module addresses on an SLC loop. It responds to regular polls from the control panel and reports its type and the status (open/normal/short) of its Initiating Device Circuit (IDC). A flashing LED indicates that the module is in communication with the control panel. The LED latches steady on alarm (subject to current limitations on the loop).

### NMM-100(A) SPECIFICATIONS

**Nominal operating voltage:** 15 to 32 VDC.

**Maximum current draw:** 5.0 mA (LED on).

**Average operating current:** 350  $\mu$ A (LED flashing), 1 communication every 5 seconds, 47k EOL.

**Maximum IDC wiring resistance:** 40 ohms.

**EOL resistance:** 47K ohms.

**Temperature range:** 32°F to 120°F (0°C to 49°C).

**Humidity range:** 10% to 93% noncondensing.

**Dimensions:** 4.5" (11.43 cm) high x 4" (10.16 cm) wide x 1.25" (3.175 cm) deep. Mounts to a 4" (10.16 cm) square x 2.125" (5.398 cm) deep box.

### ➤ NMM-100P(A) Mini Monitor Module

- Built-in type identification automatically identifies this device as a monitor module to the panel.
- Powered directly by two-wire SLC loop. No additional power required.
- High noise (EMF/RFI) immunity.
- Tinned, stripped leads for ease of wiring.
- Direct Decade entry of address: 01 – 99 on FireWarden-100-2, 01 – 50 on FireWarden-50.

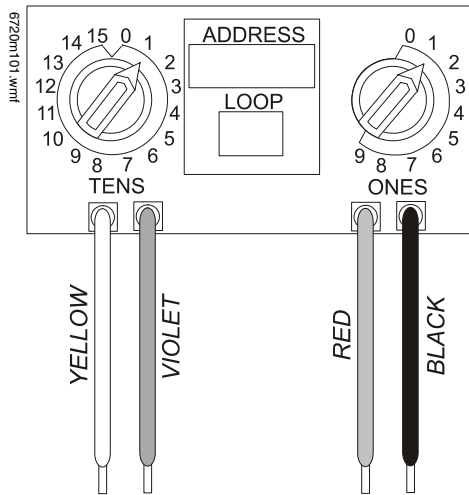

The NMM-100P(A) Mini Monitor Module can be installed in a single-gang junction directly behind the monitored unit. Its small size and light weight allow it to be installed without rigid mounting. The NMM-100P(A) is intended for use in intelligent, two-wire systems where the individual address of each module is selected using rotary switches. It provides a two-wire initiating device circuit for normally-open-contact fire alarm and security devices. NMM-100P(A)

#### **NMM-100P(A) APPLICATIONS**

Use to monitor a single device or a zone of four-wire smoke detectors, manual fire alarm pull stations, waterflow devices, or other normally-open dry-contact devices. May also be used to monitor normally-open supervisory devices with special supervisory indication at the control panel. Monitored circuit/device is wired as an NFPA Style B (Class B) Initiating Device Circuit. A 47K ohm End-of-Line Resistor (provided) terminates the circuit.

#### **NMM-100P(A) OPERATION**

Each NMM-100P(A) uses one of the available module addresses on an SLC loop. It responds to regular polls from the control panel and reports its type and the status (open/normal/short) of its Initiating Device Circuit (IDC).

#### **NMM-100P(A) SPECIFICATIONS**

**Nominal operating voltage:** 15 to 32 VDC.

**Average operating current:** 350  $\mu$ A, 1 communication every 5 seconds, 47k EOL; 600  $\mu$ A Max. (Communicating, IDC Shorted).

**Maximum IDC wiring resistance:** 40 ohms.

**Maximum IDC Voltage:** 11 Volts.

**Maximum IDC Current:** 400  $\mu$ A.

**EOL resistance:** 47K ohms.

**Temperature range:** 32°F to 120°F (0°C to 49°C).

**Humidity range:** 10% to 93% noncondensing.

**Dimensions:** 1.3" (3.302 cm) high x 2.75" (6.985 cm) wide x 0.65" (1.651 cm) deep.

**Wire length:** 6" (15.24 cm) minimum.

#### **NZM-100(A) Interface Module**

- Supports compatible two-wire smoke detectors.
- Supervises IDC wiring and connection of external power source.
- High noise (EMF/RFI) immunity.
- SEMS screws with clamping plates for ease of wiring.

- Direct Decade entry of address; 01 – 99 on FireWarden-100-2, 01 – 50 on FireWarden-50.
- LED flashes during normal operation.
- LED latches steady to indicate alarm on command from control panel.

The NZM-100(A) Interface Module is intended for use in intelligent, addressable systems, where the individual address of each module is selected using built-in rotary switches. This module allows intelligent panels to interface and monitor two-wire conventional smoke detectors. It transmits the status (normal, open, or alarm) of one full zone of conventional detectors back to the control panel. All two-wire detectors being monitored must be UL compatible with the module.

#### **NZM-100(A) APPLICATIONS**

Use the NZM-100(A) to monitor a zone of two-wire smoke detectors. The monitored circuit may be wired as an NFPA Style B (Class B) or Style D (Class A) Initiating Device Circuit. A 3.9 K ohm End-of-Line Resistor (provided) terminates the end of the Style B or D (class B or A) circuit (maximum IDC loop resistance is 25 ohms). Install ELR across terminals 8 and 9 for Style D application.

#### **NZM-100(A) OPERATION**

Each NZM-100(A) uses one of the available module addresses on an SLC loop. It responds to regular polls from the control panel and reports its type and the status (open/normal/short) of its Initiating Device Circuit (IDC). A flashing LED indicates that the module is in communication with the control panel. The LED latches steady on alarm (subject to current limitations on the loop).

#### **NZM-100(A) SPECIFICATIONS**

**Nominal operating voltage:** 15 to 32 VDC.

**Maximum current draw:** 5.1 mA (LED on).

**Maximum IDC wiring resistance:** 25 ohms.

**Average operating current:** 300  $\mu$ A, 1 communication and 1 LED flash every 5 seconds, 3.9k eol.

**EOL resistance:** 3.9K ohms.

**External supply voltage (between Terminals T3 and T4):**

DC voltage: 24 volts power limited. Ripple voltage: 0.1 Vrms maximum. Current: 90 mA per module maximum.

**Temperature range:** 32°F to 120°F (0°C to 49°C).

**Humidity range:** 10% to 93% noncondensing.

**Dimensions:** 4.5" (11.43 cm) high x 4" (10.16 cm) wide x 1.25" (3.175 cm) deep. Mounts to a 4" (10.16 cm) square x 2.125" (5.398 cm) deep box.

#### **NDM-100(A) Dual Monitor Module**

The NDM-100(A) Dual Monitor Module is intended for use in intelligent, two-wire systems. It provides two independent two-wire initiating device circuits (IDCs) at two separate, consecutive addresses. It is capable of monitoring normally open contact fire alarm and supervisory devices. The module has a single panel-controlled LED.

**NOTE:** The NDM-100(A) provides two Style B (Class B) IDC circuits ONLY. Style D (Class A) IDC circuits are NOT supported in any application.

#### **NDM-100(A) SPECIFICATIONS**

**Normal operating voltage range:** 15 to 32 VDC.

**Maximum current draw:** 6.4 mA (LED on).

**Average operating current:** 750  $\mu$ A (LED flashing).

**Maximum IDC wiring resistance:** 1,500 ohms.

**Maximum IDC Voltage:** 11 Volts.

**Maximum IDC Current:** 240  $\mu$ A

**EOL resistance:** 47K ohms.

**Maximum SLC Wiring resistance:** 40 Ohms.

**Temperature range:** 32° to 120°F (0° to 49°C).

**Humidity range:** 10% to 93% (non-condensing).

**Dimensions:** 4.5" (11.43 cm) high x 4" (10.16 cm) wide x 2.125" (5.398 cm) deep.

### **NDM-100(A) AUTOMATIC ADDRESSING**

The NDM-100(A) automatically assigns itself to two addressable points, starting with the original address. For example, if the NDM-100(A) is set to address "26", then it will automatically assign itself to addresses "26" and "27".

**NOTE:** "Ones" addresses on the NDM-100(A) are 0, 2, 4, 6, or 8 only. Terminals 6 and 7 use the first address, and terminals 8 and 9 use the second address.



#### **CAUTION:**

Avoid duplicating addresses on the system.

---

## **Installation**

NMM-100(A), NZM-100(A), and NDM-100(A) modules mount directly to a standard 4" (10.16 cm) square, 2.125" (5.398 cm) deep, electrical box. They may also be mounted to the SMB500 surface-mount box. Mounting hardware and installation instructions are provided with each module. All wiring must conform to applicable local codes, ordinances, and regulations. These modules are intended for power-limited wiring only.

The NMM-100P(A) module is intended to be wired and mounted without rigid connections inside a standard electrical box. All wiring must conform to applicable local codes, ordinances, and regulations.

## **Agency Listings and Approvals**

In some cases, certain modules may not be listed by certain approval agencies, or listing may be in process. Consult factory for latest listing status.

- **UL:** S635
- **ULC:** S635
- **FM Approved**
- **CSFM:** 7300-0028:230 (NMM-100, NMM-100P, NZM-100); 7300-0028:237 (NDM-100)
- **MEA:** 72-01-E Vol. 2 (NMM-100, NMM-100P, NZM-100); 227-03-E Vol. 3 (NDM-100)

## **Product Line Information**

**NOTE:** "A" or suffix indicates ULC-listed model.

**NMM-100(A):** Monitor module.

**NMM-100P(A):** Monitor module, miniature.

**NZM-100(A):** Monitor module, two-wire detectors.

**NDM-100(A):** Monitor module, dual, two independent Class B circuits.

**SMB500:** Optional surface-mount backbox.

**NOTE:** See installation instructions and refer to the SLC Wiring Manual, PN 52304.

---

Notifier® and FireWarden® are registered trademarks and FireWatch™ is a trademark of Honeywell International Inc.  
©2009 by Honeywell International Inc. All rights reserved. Unauthorized use of this document is strictly prohibited.



This document is not intended to be used for installation purposes.  
We try to keep our product information up-to-date and accurate.  
We cannot cover all specific applications or anticipate all requirements.  
All specifications are subject to change without notice.



Made in the U.S. A.

# Multi-Voltage Conventional Relays

 **NOTIFIER**<sup>®</sup>  
by Honeywell

Miscellaneous

## General

System Sensor's multi-voltage conventional relays are used for high-current switching applications such as fan and damper assembly control, door control, air handling unit controls, and other types of system interfacing.

The R-10T(A)/20T(A) and R-14T(A)/R-24T(A) models are multi-voltage relays with terminal strip field wiring connections, mounting track and hardware. The R-10T(A) is a single FORM-C (SPDT) relay with a red activation LED, and the R-14T(A) is a 4-gang 1 FORM-C (SPDT) relay with 4 red activation LEDs. The R-20T(A) is a single 2 FORM-C (DPDT) relay with red activation LED, and the R-24T(A) is a 4-gang 2 FORM-C (DPDT) relay with 4 red activation LEDs.

The R-10E(A)/R-20E(A) and R-14E(A)/R-24E(A) are similar to the T series track mount relays, but they are mounted into a steel enclosure. The enclosure has a removable front cover that provides easy access and a LED viewing hole on the top of the cover.

PR-1(A)/PR-2(A)/PR-3(A) are epoxy encapsulated multi-voltage relays. They are single pole double throw relays that use a red LED as a visible indication of relay coil energization. PR-3 is identical to PR-2 except it has an extra pair of wires for redundant power input.

Model EOLR-1(A) is an epoxy encapsulated single pole single throw, normally open relay that can be used as an end of line device in fire alarm systems, e.g. to supervise power supplies.

## Specifications

### R-10T(A)/R-14T(A)/R-20T(A)/ R-24(A)T

**Operating Voltage Range:** 18-35 VDC, 18-35 VAC, 115 VAC, 230 VAC.

**Operating Current:** 23 mA @ 24 VDC, 59 mA @ 24 VAC, 150 mA @ 120 VAC, 180 mA @ 240 VAC [R-10T(A)/R-14T(A)].

40 mA DC max. @ 24 VDC, 24 VAC, 92 mA @ 24 VAC, 220 mA @ 120 VAC, 260 mA @ 240 VAC [R-20T(A)/R-24T(A)]

**Humidity Range:** 10% to 93% (non-condensing).

**Dimensions:** R-10T(A)/ R-20T(A): 2.5"L x 3.35"W x 1.2"H.

R-14T(A)/R-24T(A): 10"L x 3.35"W x 1.2"H.

**Operating Temperature:** -40° F to 158° F (-40°C to 70°C)

**Contact Ratings:** 24 VDC: 7A with L/R = 5 mS.  
120 VAC: 10 A.  
120 VAC: 1/6 HP.  
230 VAC: 7 A.

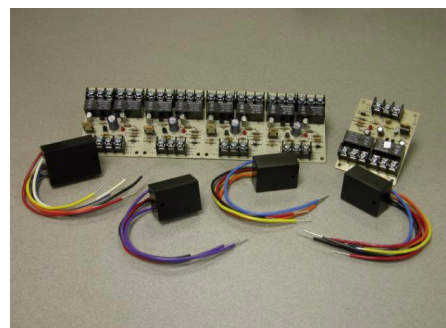

Multi-Voltage Conventional Relays

7015dn016g10r

### R-10E(A)/ R-14E(A)/R-20E(A)/ R-24E(A)

**Operating Voltage Range:** 18-35 VDC, 18-35 VAC, 115 VAC, 230 VAC.

**Operating Current:** 23 mA DC max. @ 24 V, 59 mA @ 24 VAC, 150 mA @ 120 VAC, 180 mA @ 240 VAC [R-10E(A)/R-14E(A)].

-40 mA DC max. @ 24 VDC, 24 VAC, 115 VAC, 230 VAC (R-20E/R-24E).

**Humidity Range:** 10% to 93% (non-condensing).

**Dimensions:** R-10E(A)/R-20E(A): 5.1"L x 3.75"W x 2.5"H.

R-14E(A)/R-24E(A): 11"L x 5.3"W x 2.5"H.

**Operating Temperature:** -40° F to 158° F (-40° C to 70° C).

**Contact Ratings:** 24 VDC: 7 A with L/R = 5mS.  
120 VAC: 10 A.  
120 VAC: 1/6 HP.  
230 VAC: 7 A.

### PR-1(A)

**Operating Voltage Range:** 18-35 VDC, 18-35 VAC, 120 VAC.

**Operating Current:** 15 mA DC max. @ 24 VDC, 24 VAC, 120VAC.

**Humidity Range:** 10% to 93% RH.

**Dimensions:** 0.87" H x 2.01" W x 1.42" D.

**Operating Temperature:** -40° F to 158° F (-40° C to 70° C).

**Contact Ratings:** 24 VDC: 7 A with LR = 5 mS.  
120 VAC: 7 A max. (0.35 PF).  
250 VAC: 10 A resistive.  
30 VDC: 10 A resistive.

**Wire Length:** 8" minimum.

### **PR-2(A)/PR-3(A)**

<b>Operating Voltage Range:</b>	10 to 40 VDC.
<b>Operating Current:</b>	30 mA DC max.
<b>Humidity Range:</b>	10% to 93% RH.
<b>Dimensions:</b>	0.91" H x 1.65" W x 1.22" D.
<b>Operating Temperature:</b>	-40° F to 158° F (-40° C to 70° C).
<b>Contact Ratings:</b>	120 VAC: 10 A (resistive load). 120 VAC: 7 A max. (0.35 PF). 250 VAC: 10 A max. (resistive load). 30 VDC: 10 A max. (resistive load).
<b>Wire Length:</b>	8" minimum.

### **EOLR-1(A)**

<b>Operating Voltage Range:</b>	9 to 40 VDC.
<b>Operating Current:</b>	20 mA DC max.
<b>Humidity Range:</b>	10% to 93% RH.
<b>Operating Temperature:</b>	-22° F to 140° F (-30° C to 60° C).
<b>Contact Ratings:</b>	120 VAC: 0.5 A max. (resistive load). 30 VDC: 3 A max. (resistive load).
<b>Wire Length:</b>	8" minimum.

## **Agency Listings and Approvals**

In some cases, certain modules may not be listed by certain approval agencies, or listing may be in process. Consult factory for latest listing status.

- UL/ULC Listed: S3705
- ULC Listed: CS669
- MEA: 419-04-E
- CSFM: 7300-1653:173

## **PRODUCT LINE INFORMATION**

**NOTE:** "A" suffix indicates ULC listed model.

**PR-1(A):** Epoxy encapsulated single pull double throw (SPDT) relay. It also uses a red LED as a visible indication of relay coil energization with pigtailed.

**PR-2(A):** Epoxy encapsulated single pull double throw (SPDT) activated by 10 to 40 VDC. It uses a red LED as a visible indication of relay coil energization with pigtailed.

**PR-3(A):** Epoxy encapsulated single pull double throw (SPDT) activated by 10 to 40 VDC. It contains an additional black and red wire for redundant power input with pigtailed.

**EOLR(A):** Epoxy encapsulated single pull single throw (SPST) normally open relay that is activated by 9 to 40 VDC. This relay can be used as an end of line device in fire alarm systems, e.g., to supervise power supplies.

**R-10T(A):** Single (SPDT) relay with a red activation LED.

**R-14T(A):** 4-gang (SPDT) relay with 4 red activation LEDs.

**R-20T(A):** Single (DPDT) relay with a red activation LED.

**R-24T(A):** 4-gang (DPDT) relay with 4 red activation LEDs.

**R-10E(A):** Single (SPDT) relay with a red activation LED.

**R-14E(A):** 4-gang (SPDT) relay with 4 red activation LEDs.

**R-20E(A):** Single (DPDT) relay with a red activation LED.

**R-24E(A):** 4-gang (DPDT) relay with 4 red activation LEDs.



7015pr1.jpg

**PR-1(A)**



7015pr2.jpg

**PR-2(A)**



7015pr3.jpg

**PR-3(A)**

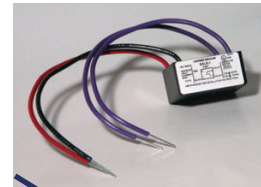

7015eolr1.jpg

**EOLR-1(A)**



7015r10t.jpg

**R-10T(A)**

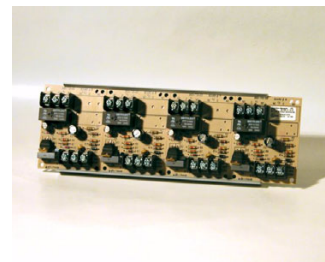

7015r14t.jpg

**R-14T(A)**

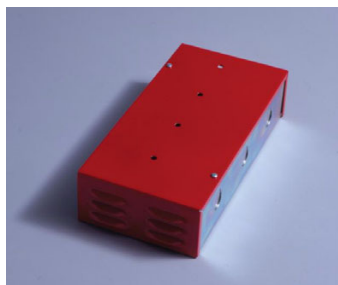

7015r20-24e.jpg

**R-20E(A) & R-24E(A)  
Enclosures**



7015r10-14e.jpg

**R-10E(A) & R-14E(A)  
Enclosures**



---

©2008 by Honeywell International Inc. All rights reserved. Unauthorized use of this document is strictly prohibited.



This document is not intended to be used for installation purposes.  
We try to keep our product information up-to-date and accurate.  
We cannot cover all specific applications or anticipate all requirements.  
All specifications are subject to change without notice.

# BB-XP Cabinet

50897  
Revision B

11/09/01  
ECN 01-488

The BB-XP Cabinet is hinged on the left, and is shipped assembled with a chassis installed. Below are the cabinet dimensions for installation.

Cabinet Door

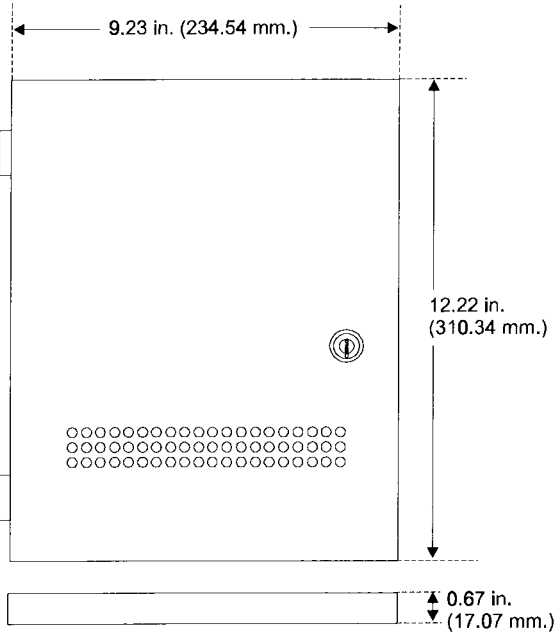

Cabinet

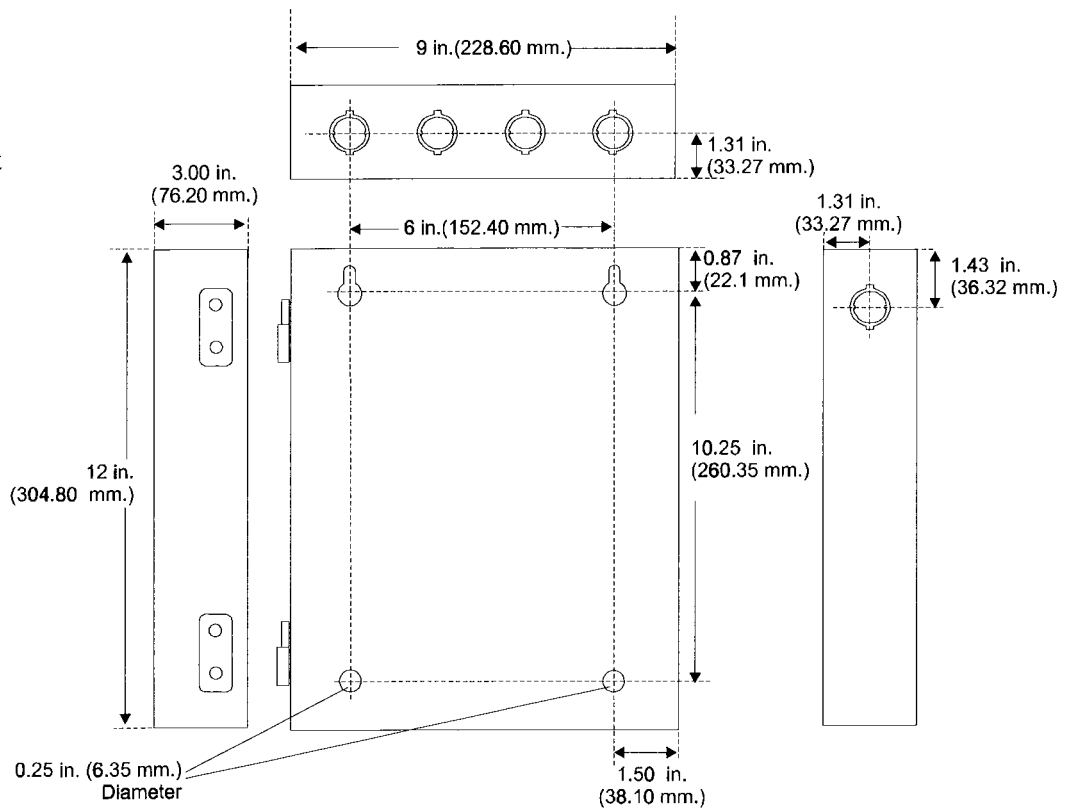

BBXP.wmf

# Wheelock® Exceder™

## Horns and Strobes



### Audio/Visual Devices

#### General

The Wheelock® Exceder™ Series of notification appliances feature a sleek modern design and numerous features including eight candela options in one appliance, low current draw, no tools needed for setting changes, 12/24 VDC operation, universal mounting base and multiple mounting options.

Models with an audible feature 3 sound settings (90, 95, 99 dB). All switches to change settings can be set without the use of a tool and are located behind the appliance to prevent tampering. Wall models feature voltage test points to take readings with a voltage meter for troubleshooting and AHJ inspection.

The Wheelock® Exceder™ Series of wall and ceiling notification appliances feature a Universal Mounting Base (UMB) designed to simplify the installation and testing of horns, strobes, and combination horn strobes. The separate universal mounting base can be pre-wired to allow full testing of circuit wiring before the appliance is installed and the surface is finished. It comes complete with a contact cover for protection against dirt, dust, paint and damage to the contacts. The contact cover also acts as a shunting device to allow pre-wire testing for common wiring issues.

The contact cover is polarized to prevent it from being installed incorrectly and prevents the appliance from being installed while it is on the UMB. When the contact cover is removed the circuit will show an open until the appliance is installed. The UMB allows for consistent installation and easy replacement of appliances if required. Wall models provide an optional locking screw for extra secure installation, while the ceiling models provide a captive screw to prevent the screw from falling during installation.

#### Features

- Multiple voltages
- Voltage test points for quick troubleshooting and easy spot-checking (wall models only)
- 3 audible settings (90, 95, 99 dB)
- 8 Candela settings
  - Wall - 15/1575/30/75/95/110/135/185
  - Ceiling - 15, 30, 60, 75, 95, 115, 150, 177
- Finger-slide switches
- Sleek modern aesthetics
- Common base for wall and ceiling with 5 mounting options:
  - 1-gang
  - 2-gang
  - 4 inch square
  - 3.5 inch octagonal
  - 4 inch octagonal

#### Compatibility and Requirements

- Synchronize using Wheelock Sync Modules, or panels with built-in Wheelock patented sync protocol.
- Compatible with UL “Regulated Voltage” using filtered VDC or unfiltered VRMS input voltage
- Strobes produce one flash per second over the Regulated Voltage range.



Wall



Ceiling



#### General Notes

- All candela ratings represent minimum effective strobe intensity based on UL Standard 1971.
- Series Exceder Strobe products are Listed under UL Standards 1971 and 464 for indoor use with a temperature range of 32°F to 120°F (0°C to 49°C) and maximum humidity of 93% (± 2%) UL 464 (85% UL 1971).
- Series Exceder horns are under UL Standard 464 for audible signal appliances (Indoor use only).
- Product naming conventions: The Exceder line's model codes break down into easy-to-remember codes. HN = Horn, ST = Strobe, HS = Horn-strobe, C = Ceiling Mount, W = White, and R = Red. So “STRC” can be read as “Strobe, Red, Ceiling-mount.”, and “HSW” is “Horn-strobe, white, wall-mount.”
- Refer to your fire alarm panel or power supply manual when calculating the number of devices allowed per circuit.

#### Architects/Engineers Specifications

The notification appliances shall be Wheelock Exceder Series HS Audible Strobe appliances, Series ST Visual Strobe appliances and Series HN Audible appliances or approved equals. The Series HS and ST Strobes shall be listed for UL Standard 1971 (Emergency Devices for the Hearing-Impaired) for Indoor Fire Protection Service. The Series HS and HN Audibles shall be UL Listed under Standard 464 (Fire Protective Signaling). All Series shall meet the requirements of FCC Part 15 Class B. All inputs shall be compatible with standard reverse polarity supervision of circuit wiring by a Fire Alarm Control Panel (FACP) with the ability to operate from 8 to 33 VDC. Indoor wall models shall incorporate voltage test points for easy voltage inspection.

The Series HS Audible Strobe and ST Strobe appliances shall produce a flash rate of one flash per second over the Regulated Voltage Range and shall incorporate a Xenon flashtube enclosed in a rugged Lexan® lens. The Series shall be of low current design. Where Multi-Candela appliances are specified, the strobe intensity shall have 8 field selectable settings at 15,

15/75, 30, 75, 95, 110, 135, 185 candela for wall mount and 15, 30, 60, 75, 95, 115, 150, 177 candela for ceiling mount. The selector switch for selecting the candela shall be tamper resistant. The 15/75 candela strobe shall be specified when 15 candela UL Standard 1971 Listing with 75 candela on-axis is required (e.g. ADA compliance). Appliances with candela settings shall show the candela selection in a visible location at all times when installed.

The audible shall have a minimum of three field selectable settings for dBA levels and shall have a choice of continuous or temporal (Code 3) audible outputs.

**MOUNTING OPTIONS**

The Series HS Audible Strobe, ST Strobe and Series HN Audible shall incorporate a patented Universal Mounting Base that shall allow mounting to a single-gang, double-gang, 4" square, 3.5" octagonal, 4" octagonal or 100mm European type back boxes. Two wire appliance wiring shall be capable of directly connecting to the mounting base. Continuity checking of the entire NAC circuit prior to attaching any notification appliances shall be allowed. Product shall come with contact cover to protect contact springs. Removal of an appliance shall result in a supervision fault condition by the Fire Alarm Control Panel (FACP). The mounting base shall be the same base among all horn, strobe, horn strobe, wall and ceiling models. All notification appliances shall be backwards compatible.

**PHYSICAL SPECIFICATIONS**

The Series HS and ST wall models shall have a low profile measuring 5.24" H x 4.58" W x 2.19" D. Series HN wall shall measure 5.24" H x 4.58" W x 1.6" D. The Series HSC and STC

shall be round and have a low profile with a diameter of 6.68" x 2.63" D. Series HNC ceiling shall have a diameter of 6.68" x 1.50" D.

**SYNCHRONIZATION**

When synchronization is required, the appliance shall be compatible with Wheelock's SM, DSM Sync Modules, Wheelock Power Supplies or other manufacturer's panels with built-in Wheelock Patented Sync Protocol. The strobes shall not drift out of synchronization at any time during operation. If the sync protocol fails to operate, the strobe shall revert to a non-synchronized flash-rate and still maintain one flash per second over its Regulated Voltage Range. The appliance shall also be designed so that the audible signal may be silenced while maintaining strobe activation when used with Wheelock synchronization protocol.

**Standards and Codes**

Modules in this series comply with UL Standard 1971, UL Standard 464, California State Fire Marshal (CSFM), and ULC.

**Agency Listings**

These listings and approvals apply to the modules specified in this document. In some cases, certain modules or applications may not be listed by certain approval agencies, or listing may be in process. Consult factory for latest listing status.

- **UL Listed:** S5391 (Strobes); E5946 (Horns, Horn/strobes).
- **ULC Listed**
- **CSFM Listed:** 7125-0785:168.

**Specification & Ordering Information**

Model	Strobe Candela	12/24 VDC	Mounting Options
<b>Horn Strobes</b>			
HSR	15, 15/75, 30, 75, 95, 110, 135, 185	X	Universal Mounting Base
HSW	15, 15/75, 30, 75, 95, 110, 135, 185	X	Universal Mounting Base
HSRC	15, 30, 60, 75, 95, 115, 150, 177	X	Universal Mounting Base
HSWC	15, 30, 60, 75, 95, 115, 150, 177	X	Universal Mounting Base
<b>Strobes</b>			
STR	15, 15/75, 30, 75, 95, 110, 135, 185	X	Universal Mounting Base
STW	15, 15/75, 30, 75, 95, 110, 135, 185	X	Universal Mounting Base
STRC	15, 30, 60, 75, 95, 115, 150, 177	X	Universal Mounting Base
STWC	15, 30, 60, 75, 95, 115, 150, 177	X	Universal Mounting Base
<b>Horns</b>			
HNR	—	X	Universal Mounting Base
HNW	—	X	Universal Mounting Base
HNRC	—	X	Universal Mounting Base
HNWC	—	X	Universal Mounting Base
*12 VDC models feature 15 and 15/75 settings			
<b>NOTE:</b> Due to continuous development of Cooper Wheelock products, specifications and offerings are subject to change without notice in accordance with Cooper Wheelock Inc., dba Cooper Notification standard terms and conditions.			

Notifier® is a registered trademark of Honeywell International Inc. Exceder is a trademark and Wheelock® is a registered trademark of Cooper Notification. ©2010 by Honeywell International Inc. All rights reserved. Unauthorized use of this document is strictly prohibited.

This document is not intended to be used for installation purposes. We try to keep our product information up-to-date and accurate. We cannot cover all specific applications or anticipate all requirements. All specifications are subject to change without notice.



## ➤ FCPS-24S6(C/E) & FCPS-24S8(C/E)

### 6- & 8-Amp 24-Volt Remote Power Supplies



Power Supplies

#### General

The FCPS-24S6E (6-amp) and FCPS-24S8E (8-amp) are remote power supplies with battery charger. The FCPS-24S6/-24S8 may be connected to any 12 or 24 volt fire alarm control panel (FACP) or may be used as stand-alone supplies. Primary applications include notification appliance (bell) circuit (NAC) expansion (to support ADA requirements and NAC synchronization) or auxiliary power to support 24 volt system accessories. The FCPS-24S6/-24S8 provides regulated and filtered 24 VDC power to four notification appliance circuits configured as either four Class B (Style Y) or Class A (Style Z, with ZNAC-4 option module). Alternately, the four outputs may be configured as all non-resettable, all resettable or two non-resettable and two resettable. The FCPS-24S6/-24S8 also contains a battery charger capable of charging up to 18 AH batteries. FCPS-24S6C & FCPS-24S8C are ULC-listed.

**NOTE:** Unless otherwise specified, the terms FCPS-24S6 and FCPS-24S8 used in this document refers to the standard FCPS-24S6 and FCPS-24S8, FCPS-24S6C and FCPS-24S8C, the FCPS-24S6E and FCPS-24S8E

#### Features

- UL-Listed NAC synchronization using System Sensor, Wheelock, or Gentex "Commander<sup>2</sup>" appliances.
- Operates as a "sync-follower" or as a "sync-generator" (default). See note on page 2.
- Contains two fully-isolated input/control circuits - triggered from FACP NAC (NAC expander mode) or jumped permanently "ON" (stand-alone mode).
- Four Class B (Style Y) or four Class A (Style Z, with ZNAC-4 module) NACs.
- 6-amp (FCPS-24S6) or 8-amp (FCPS-24S8) full load output, with 3 amps maximum/circuit, in NAC expander mode (UL 864).
- 4-amp (FCPS-24S6) or 6-amp (FCPS-24S8) continuous output in stand-alone mode (UL 1481).
- Compatible with coded inputs; signals passed through.
- Optional power-supervision relay (EOLR-1).
- In stand-alone mode, output power circuits may be configured as: resettable, (reset line from FACP required), non-resettable, or a mix of two and two.
- Fully regulated and filtered power output - optimal for powering four-wire smoke detectors, annunciators, and other system peripherals requiring regulated/filtered power.
- Power-limiting technology meets UL power-limiting requirements.
- Form-C normally-closed trouble relay.
- Fully supervised power supply, battery, and NACs.
- Selectable earth fault detection.
- AC trouble report selectable for immediate 2-hour delay.
- Works with virtually any UL 864 fire alarm control which utilizes an industry-standard reverse-polarity notification circuit (including unfiltered and unregulated bell power).
- Requires input trigger voltage of 9 - 32 VDC.
- Self-contained in compact, locking cabinet - 15"H x 14.5"W x 2.75"D (cm: 38.1H x 36.83W x 6.985D).

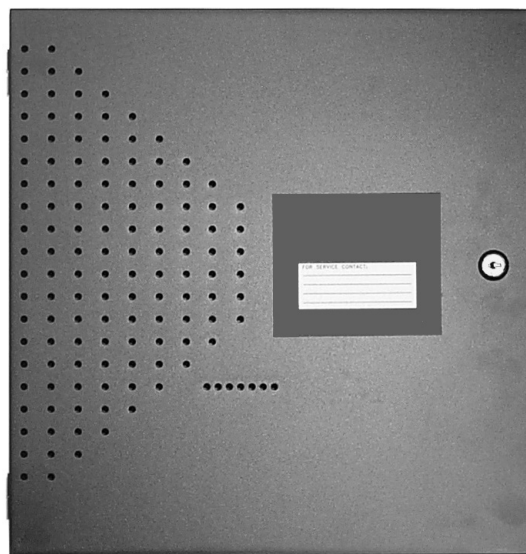

6927photo.jpg

- Includes integral battery charger capable of charging up to 18 AH batteries. Cabinet capable of housing 7.0 AH batteries.
- Battery charger may be disabled via DIP switch for applications requiring larger batteries.
- Fixed, clamp-type terminal blocks accommodate up to 12 AWG (3.1mm<sup>2</sup>) wire.

#### Specifications

##### Primary (AC) Power:

- FCPS-24S6C/-24S8C: 120 VAC, 60 Hz, 3.2A maximum.
- FCPS-24S6E/-24S8E: 240 VAC, 50 Hz, 1.6A maximum.
- Wire Size: minimum #14 AWG (2.0mm<sup>2</sup>) with 600 V insulation.

##### Control Input Circuit:

- **Trigger Input Voltage:** 9 to 32 VDC.
- **Trigger Current:** 2.0 mA (16 - 32 V); Per Input: 1.0 mA (9 - 16 V).

##### Trouble Contact Rating: 5 A at 24 VDC.

**Auxiliary Power Output:** Specific application power 500 mA maximum.

##### Output Circuits:

- +24 VDC filtered, regulated.
- 3.0 A maximum for any one circuit.
- Total continuous current for all outputs (stand-alone mode):
  - FCPS-24S6: 4.0 A maximum.
  - FCPS-24S8: 6.0 A maximum.
- Total short-term current for all outputs (NAC expander mode):
  - FCPS-24S6: 6.0 A maximum.
  - FCPS-24S8: 8.0 A maximum.

##### Secondary Power (Battery) Charging Circuit:

- Supports lead-acid batteries only.
- Float-charge voltage: 27.6 VDC.

- Maximum current charge: 1.5 A.
- Maximum battery capacity: 18 AH.

## Applications

**Example 1:** Expand notification appliance power an additional 6.0 A (FCPS-24S6) or 8.0 A (FCPS-24S8). Use up to four Class B (Style Y) outputs or four Class A (Style Z) outputs (using ZNAC-4). For example, the FACP notification appliance circuits will activate the FCPS when reverse-polarity activation occurs. Trouble conditions on the FCPS are sensed by the FACP through the notification appliance circuit.

**Example 2:** Use the FCPS to expand auxiliary regulated 24-volt system power up to 4.0 A (FCPS-24S6) or up to 6.0 A (FCPS-24S8). Both resettable and non-resettable power options are available. Resettable outputs are created by connecting the resettable output from the FACP to one or both of the FCPS inputs.

**Example 3:** Use addressable control modules to activate the FCPS instead of activating it through the FACP notification appliance circuits. This typically allows for mounting the FCPS at greater distances\* away from the FACP while expanding system architecture in various applications.

For example, an addressable control module is used to activate the FCPS, and an addressable monitor module is used to sense FCPS trouble conditions. Local auxiliary power output from the FCPS provides power to the addressable control module.

*\*NOTE: Addressable FACP's are capable of locating control and monitor modules at distances of up to 12,500 feet (3,810 meters).*

## Sync Follower/Generator Note

In some installations, it is necessary to synchronize the flash timing of all strobes in the system for ADA compliance. Strobes accomplish this by monitoring very short timing pulses on the NAC power which are created by the FACP. When installed at the end of a NAC wire run, the FCPS-24S6/-24S8 can track (i.e. "follow") the strobe synchronization timing pulses on the existing NAC wire run. This maintains the overall system flash timing of the additional strobes attaches to the FCPS.

When the FCPS-24S6/-24S8 is configured (via DIP switch settings) as a "sync follower," the FCPS's NAC outputs track the strobe synchronization pulses present at the FCPS's sync input terminal. The pulses originate from an upstream FACP or other power supply.

When the FCPS-24S6/-24S8 are configured (via DIP switch settings) as a "sync generator," the FCPS's sync input terminals are not used. Rather, the FCPS is the originator of the strobe synchronization pulses on the FCPS's NAC outputs. In "sync generator" mode, the sync type (System Sensor, Wheelock, or Gentex) is selectable via DIP switch settings.

## Standards and Codes

The FCPS-24S6 and FCPS-24S8 comply with the following standards:

- **NFPA 72** National Fire Alarm Code.
- **UL 864** Standard for Control Units for Fire Alarm Systems (NAC expander mode).
- **UL 1481** Power Supplies for Fire Alarm Systems.

## Agency Listings and Approvals

These listings and approvals apply to the modules specified in this document. In some cases, certain modules or applications may not be listed by certain approval agencies, or listing may be in process. Consult factory for latest listing status.

- **UL Listed:** S635, S674
- **ULC Listed:** S635 (FCPS-24S6C & FCPS-24S8C)
- **CSFM Approved:** 7315-0028:225
- **MEA:** 299-02-E
- **FM Approved**

## Ordering Information

**FCPS-24S6:** 6.0 A, 120 VAC remote charger power supply. Includes main printed circuit board, transformers, enclosure (15"H x 14.5"W x 2.75"D [cm: 38.1H x 36.83W x 6.985D]), and installation instructions.

**FCPS-24S6C:** Same as above, ULC-listed.

**FCPS-24S6R:** Same as FCPS-24S6 with red enclosure.

**FCPS-24S6E:** 6.0 A, 240 VAC remote charger power supply. Includes main printed circuit board, transformers, enclosure (15"H x 14.5"W x 2.75"D [cm: 38.1H x 36.83W x 6.985D]), and installation instructions.

**FCPS-24S8:** 8.0 A, 120 VAC remote charger power supply. Includes main printed circuit board, transformers, enclosure (15"H x 14.5"W x 2.75"D [cm: 38.1H x 36.83W x 6.985D]), and installation instructions.

**FCPS-24S8C** Same as above, ULC-listed.

**FCPS-24S8R:** Same as FCPS-24S8 with red enclosure.

**FCPS-24S8E:** 8.0 A, 240 VAC remote charger power supply. Includes main printed circuit board, transformers, enclosure (15"H x 14.5"W x 2.75"D [cm: 38.1H x 36.83W x 6.985D]), and installation instructions.

**ZNAC-4:** Class A (Style Y) NAC option module.

**EOLR-1:** 12/24 VDC end-of-line relay for monitoring four-wire smoke detector power.

**BAT-1270:** Battery, 12-volt, 7.0 AH (two required, see BAT Series data sheet DN-6933).

**PS-1270:** Battery, 12-volt, 7.0 AH (two required, see PS Series data sheet DN-1109)

System Sensor® and NOTIFIER® are registered trademarks of Honeywell International Inc.

©2009 by Honeywell International Inc. All rights reserved. Unauthorized use of this document is strictly prohibited.



This document is not intended to be used for installation purposes.  
We try to keep our product information up-to-date and accurate.  
We cannot cover all specific applications or anticipate all requirements.  
All specifications are subject to change without notice.



Made in the U.S. A.

# NP-100(A), NP-100T(A), NP-100R(A)

dn-6995:b • A1-320

## Addressable Photoelectric Detectors for the FireWarden Series



Addressable

### General

The NP-100 and NP-100T addressable, low-profile plug-in photoelectric detectors use a state-of-the-art photoelectric sensing chamber with communications to provide open area protection and are used exclusively with NOTIFIER's **FireWarden Series** (FireWarden-100-2 and FireWarden-50) Addressable Fire Alarm Control Panels (FACPs). The NP-100T adds thermal sensors that will alarm at a fixed temperature of 135°F (57°C). Since these detectors are addressable, they will help emergency personnel quickly locate a fire during its early stages, potentially saving precious rescue time while also reducing property damage. Two LEDs on each sensor light to provide a local, visible sensor indication. Remote LED annunciator capability is available as an optional accessory (P/N RA100Z(A)). The NP-100R is a remote test capable detector for use with DNR(W) duct smoke detector housings.

### Features

#### SLC loop:

- Two-wire loop connection.
- Unit uses base for wiring.

#### Addressing:

- Addressable by device.
- Direct Decade entry of address: 01 – 99 with FireWarden-100-2, and 01 – 50 with FireWarden-50.

#### Architecture:

- Unique single-source, dual-chamber design to respond quickly and dependably to a broad range of fires.
- Sleek, low-profile design.
- Integral communications and built-in type identification.
- Built-in tamper-resistant feature.
- Removable cover and insect-resistant screen for simple field cleaning.

#### Operation:

- Withstands air velocities up to 4,000 feet-per-minute (20 m/sec.) without triggering a false alarm.
- Factory preset at 1.5% nominal sensitivity for panel alarm threshold level.
- Visible LED “blinks” when the unit is addressed (communicating with the fire panel) and latches on in alarm.

#### Mechanicals:

- Sealed against back pressure.
- Direct surface mounting or electrical box mounting.
- Mounts to: single-gang box, 3.5" (8.89 cm) or 4.0" (10.16 cm) octagonal box, or 4.0" (10.16 cm) square electrical box (using a plaster ring — included).

#### Other system features:

- Fully coated circuit boards and superior RF/transient protection.
- 94-V0 plastic flammability rating.
- Low standby current.

#### Options:

- Remote LED output connection (P/N RA100Z).



NP-100 with B710LP base



NP-100T with B710LP base

### Applications

Use photoelectric detectors in life-safety applications to provide a broad range of fire-sensing capability, especially where smoldering fires are anticipated. Ionization detectors are often better than photoelectric detectors at sensing fast, flaming fires.

### Construction

These detectors are constructed of off-white LEXAN®. NP-100(T) plug-in, low-profile smoke detectors are designed to commercial standards and offer an attractive appearance.

### Installation

NP-100(T) plug-in detectors use a detachable mounting base to simplify installation, service and maintenance. Mount base on box which is at least 1.5 inches (3.81 cm) deep. Suitable boxes include:

- 4.0" (10.16 cm) square box with plaster ring.
- 4.0" (10.16 cm) octagonal box.
- 3.5" (8.89 cm) octagonal box.
- Single-gang box.

**NOTE:** Because of the inherent supervision provided by the SLC loop, **end-of-line resistors** are not required. Wiring “T-taps” or branches are permitted for Style 4 (Class B) wiring. NP-100R mounts in a DNR(W) duct detector housing.

## Operation

Each NP-100/T/R uses one of 99 possible addresses on the FireWarden-100-2 and one of 50 possible addresses on the FireWarden-50 Signaling Line Circuit (SLC). It responds to regular polls from the system and reports its type and status.

The NP-100/T/R addressable photoelectric sensor's unique unipolar chamber responds quickly and uniformly to a broad range of smoke conditions and can withstand wind gusts up to 4,000 feet-per-minute (20 m/sec.) without sending an alarm level signal. Because of its unipolar chamber, the NP-100/T/R is approximately two times more responsive than most photoelectric sensors. This makes it a more stable detector.

## Detector Sensitivity Test

Each detector can have its sensitivity tested (required per NFPA 72, Chapter 14 on *Inspection, Testing and Maintenance*) when installed/connected to a FireWarden-100-2 or FireWarden-50 addressable fire alarm control panel. The results of the sensitivity test can be printed off the FireWarden-100-2 or FireWarden-50 for record keeping.

## Specification

**Voltage range:** 15 – 32 VDC (peak).

**Standby current:** 300  $\mu$ A @ 24 VDC.

**LED current:** 6.5 mA @ 24 VDC (latched "ON").

**Air velocity:** 4,000 ft./min. (20 m/sec.) maximum.

**Diameter:** 6.1" (15.5 cm) installed in B710LP base.

**Height:** 2.1" (5.33 cm) installed in B710LP base.

**Weight:** 3.6 oz. (102 g).

**Operating temperature range:** for **NP-100:** 0°C to 49°C (32°F to 120°F); for **NP-100T:** 0°C to 38°C (32°F to 100°F). **NP-100R:** installed in a DNR(W) -20°C to 70°C (-4°F to 158°F).

**Temperature:** 0°C – 49°C (32°F – 120°F).

**Relative humidity:** 10% – 93%, non-condensing.

## Listings

Listings and approvals below apply to the NP-100 and NP-100T detectors. In some cases, certain modules may not be listed by certain approval agencies, or listing may be in process. Consult factory for latest listing status.

- UL Listed, file S1115.
- CSFM approved: file 7272-0028:231.
- MEA approved: file 243-02-E Vol. 2.
- Maryland State Fire Marshal: permit 2173.
- FM approved.

## Product Line Information

**NP-100:** Addressable photoelectric detector; B710LP base included.

**NP-100A:** Same as NP-100 with ULC Listing (B710LPA base included).

**NP-100T:** Same as NP-100 but with *thermal* element; B710LP base included.

**NP-100TA:** Same as NP-100T with ULC Listing (B710LPAbase included).

**NP-100R:** Remote test capable addressable photoelectric detector for use with a DNR(W) duct detector housing.

**B710LP:** Plug-in detector base. Dimensions: 6.1" (15.5 cm). Mounting: 4.0" (10.16 cm) square box with or without plaster ring, 4.0" (10.16 cm) octagonal box, 3.5" (8.89 cm) octagonal box, or single-gang box. All mounting boxes have a minimum depth of 1.5" (3.81 cm).

**B224RB:** Plug-in System Sensor *relay* detector base. **Diameter:** 6.2" (15.75 cm). **Mounting:** 4.0" (10.16 cm) square box with or without plaster ring, 4.0" (10.16 cm) octagonal box, or 3.5" (8.89 cm) octagonal box. All mounting boxes have a minimum depth of 1.5" (3.81 cm).

**B224BI:** Plug-in System Sensor *isolator* detector base. Maximum 25 devices between isolator bases (see *DN-6994*). **Diameter:** 6.2" (15.75 cm). **Mounting:** 4.0" (10.16 cm) square box with or without plaster ring, 4.0" (10.16 cm) octagonal box, or 3.5" (8.89 cm) octagonal box. All mounting boxes have a minimum depth of 1.5" (3.81 cm).

**B200SR:** Sounder base capable of producing temporal-3 or steady sound output.

### ACCESSORIES:

**RA100Z(A):** Remote LED annunciator. 3 – 32 VDC. Mounts to a U.S. single-gang electrical box. *For use with B501 and B710LP bases only.*

**SMK400E:** Surface mounting kit provides for entry of surface wiring conduit. *For use with B501 base only.*

**RMK400:** Recessed mounting kit. *For use with B501 base only.*

**M02-04-00:** Test magnet.

**M02-09-00:** Test magnet with telescoping handle.

**XR2B:** Detector removal tool. Allows installation and/or removal of detector heads from bases in high ceiling applications.

**XP-4:** Extension pole for XR2B. Comes in three 5-foot (1.524 m) sections.

**T55-127-010:** Detector removal tool without pole.

**BCK-200B:** Black detector covers, box of 10 .

**WCK-200B:** White detector covers, box of 10 .

---

NOTIFIER® is a registered trademark of Honeywell International Inc. Bayblend® is a registered trademark of Bayer Corporation. ©2008 by Honeywell International Inc. All rights reserved. Unauthorized use of this document is strictly prohibited.

---



This document is not intended to be used for installation purposes.  
We try to keep our product information up-to-date and accurate.  
We cannot cover all specific applications or anticipate all requirements.  
All specifications are subject to change without notice.



**NO  
EXCUSES!**



# FAD

## ➤ Fire Alarm Documents Records / Programs / Software

The FAD is the perfect fit to meet the demanding code requirements today. SAE's number one goal is to manufacture code compliant solutions and this product allows you to do just that. NFPA 72 section 6.2.2.1 states, "A record of installed software and firmware version numbers shall be maintained at the location of the fire alarm control unit."

This durable 16 gauge steel enclosure with a solid piano hinge and key lock will keep all of your code required documents in one safe place. With a 2GB USB flash drive it stores your fire alarm software safe and secure eliminating the occurrences of the software not being on site when technicians arrive to service the system. Along with your fire alarm software you can store your test & inspection documents, service records, manuals & AS built drawings for the system. Using a standard USB B connector it allows you to plug in with any standard SB printer cable to upload or download information.

NFPA 72 section 10.18.2.1.2.8 If the documents are located in a separate enclosure or cabinet, the separate enclosure or cabinet shall be prominently labeled  
**FIRE ALARM DOCUMENTS.**

### Standard Features:

- Installed with a 2 gig digital flash drive with USB B connector
- 2 Key ring hooks to hold system keys
- Business card holder for key contacts
- Overall Dimensions are 12" x 13" tall and 2 ¼ deep
- 16 gauge steel box and cover for security
- durable powercoat baked on finish other colors available
- standard ¾" cat 30 key lock other lock assemblies available
- Solid stainless steel piano hinge
- permanently screened white ink 1" high "Fire Alarm Documents"
- Legend sheet for passwords and system information

The FAD is designed to hold critical manuals and documents with a durable steel sleeve. It has designated hooks to organize key rings and hold important business cards for easy access and reference. Inside the cover it has a organized note table that allows for documentation for passwords and other critical system information. The steel sleeve can be easily removed to hold a 1.5" three ring binder.

The innovation of a single gang cutout inside the box to implement the infinity line products with conduit knockout access enables you to provide other system functions for test and inspection. A drill switch or a shut off switch for testing are just a few examples. See the complete line of Infinity products for single gang electrical product solutions.



**ISO 9001  
REGISTERED  
COMPANY**



**ACEBOX**





**\*Important! Securing Screw  
MUST be installed in top of  
Device on Exceder series HSR  
and STR Audio Visuals.**

**Important! Wiring connections  
must have correct polarity.**

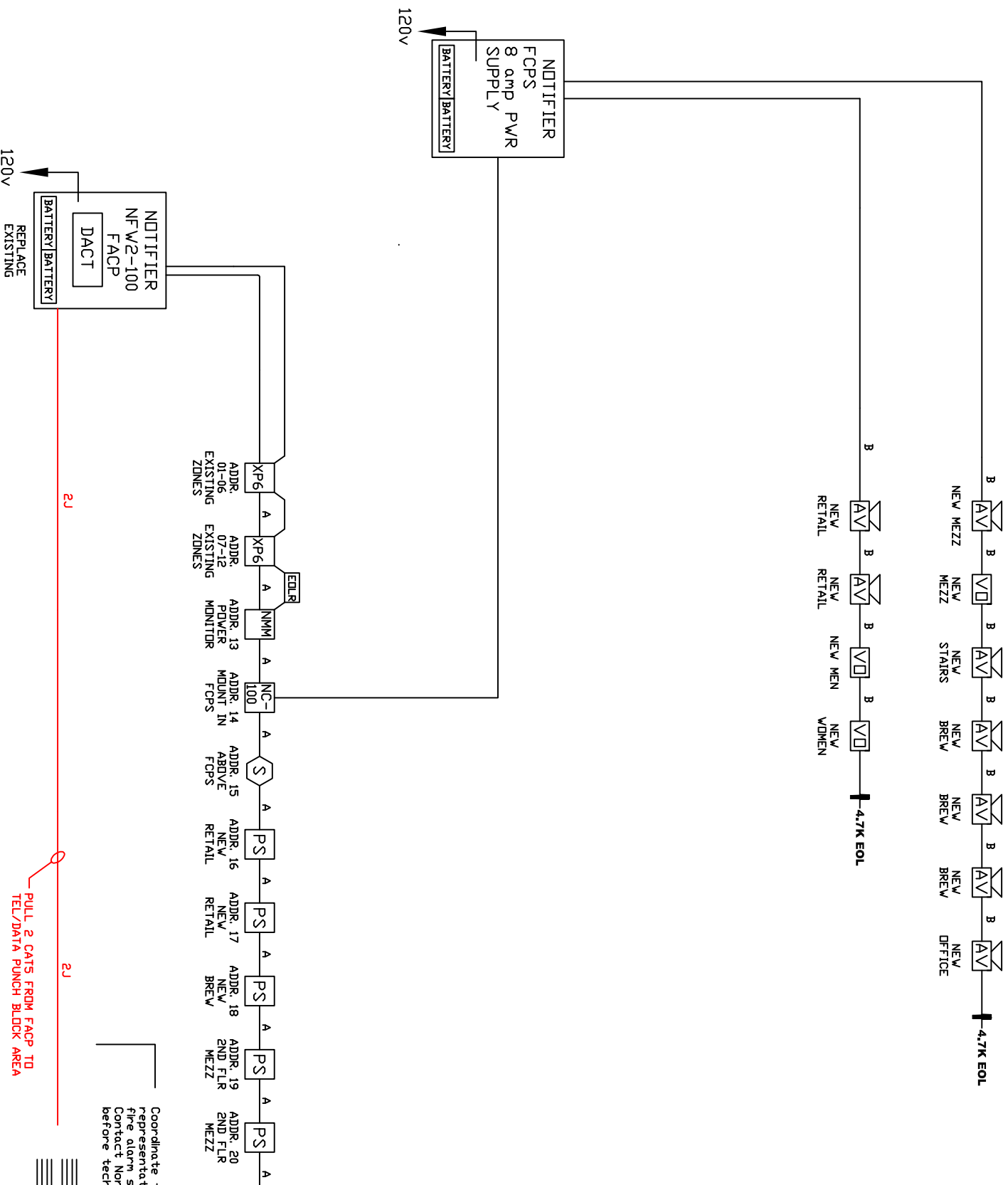

**LEGEND**

- MOUNTING HEIGHT**
  - 48 INCHES
  - 80 INCHES
  - 80 INCHES
- |  |  |
|--|--|
|  | PULL STATION                             |
|  | SMOKE DETECTOR                           |
|  | HEAT DETECTOR RATE OF RISE               |
|  | HEAT DETECTOR FIXED TEMP                 |
|  | REMOTE TEST/INDICATOR                    |
|  | DUCT SMOKE DETECTOR                      |
|  | VISUAL ONLY                              |
|  | AUDIO / VISUAL                           |
|  | ZONE MODULE                              |
|  | ZONE MODULE                              |
|  | CONTROL MODULE                           |
|  | MONITOR MODULE 100=4 SQUARE, 100P=mlkmod |
|  | END OF LINE POWER SUPERVISION            |
|  | NZM-100-6 ZONE MODULE                    |

This drawing is a typical device layout, wiring is shown, diagrammatically only. This drawing has been provided as an example ONLY. Riser does not necessarily indicate all devices and appliances. See floor plans and specification for location and quantities. The purchaser must accurately layout the initiating and notification devices in their proper zones/circuit. Note: All signal circuits have a 2.5 amp load limitation and a combined load limitation of 3.0 amps or 6.0 amps if XRM-24 is added to the panel. There can be 4 Class B nac circuits or 2 Class A nac circuits. REMOTE power supply has a 3.0 amps limitation per circuit and an 8.0 amp combined limitation for all 4 circuits. (see chart below for current vs. candela ratings)

Room Size	Candela Rating	Load (amps)
20' x 20'	15 cd	0.08 amps
28' x 28'	30 cd	0.10 amps
45' x 45'	75 cd	0.15 amps
54' x 54'	110 cd	0.20 amps

- A 1 PR #12 AVG TWISTED-PAIR UNSHIELDED CABLE FPL
- GENESIS 4515, BELDEN 6020UL (Up to 10,000 f+t)
- A 1 PR #14 AVG TWISTED-PAIR UNSHIELDED CABLE FPL
- GENESIS 4513, BELDEN 6120UL (Up to 8,000 f+t)
- A 1 PR #16 AVG TWISTED-PAIR UNSHIELDED CABLE FPL
- GENESIS 4511, BELDEN 6220UL (Up to 4,500 f+t)
- B 1 PR #12 AVG FPL CABLE
- D 1 PR #14 AVG FPL CABLE
- E 1 PR #16 AVG FPL CABLE
- F 2c #12 AVG CABLE
- G 2c #14 AVG CABLE
- H 1 PR #16 AVG TWISTED-PAIR SHIELDED CABLE FPL
- J 1 CATS CABLE

Coordinate termination's with telephone representative. Must be completed before fire alarm service visit for final certification. Contact Norris Inc. to set up monitoring before tech is scheduled.

PUNCH DOWN BLOCK  
FURNISHED BY OTHER

PULL 2 CATS FROM FACP TO TEL/DATA PUNCH BLOCK AREA

Coordinate termination's with telephone representative. Must be completed before fire alarm service visit for final certification. Contact Norris Inc. to set up monitoring before tech is scheduled.

PUNCH DOWN BLOCK  
FURNISHED BY OTHER

PULL 2 CATS FROM FACP TO TEL/DATA PUNCH BLOCK AREA

REVISION 1	DATE:
REVISION 0	DATE: 11/05/2012
SYSTEM WIRING RISER	
PROJECT NAME	SCALE NTS
<b>Allagash Brewing Adds</b>	By: <b>ZAD</b>
Portland, MAINE	CK BY:
	SAVED AS:
Prepared for Tomorrow, Delivered Today	
2257 BROADWAY, S.D. PORTLAND, MAINE	