

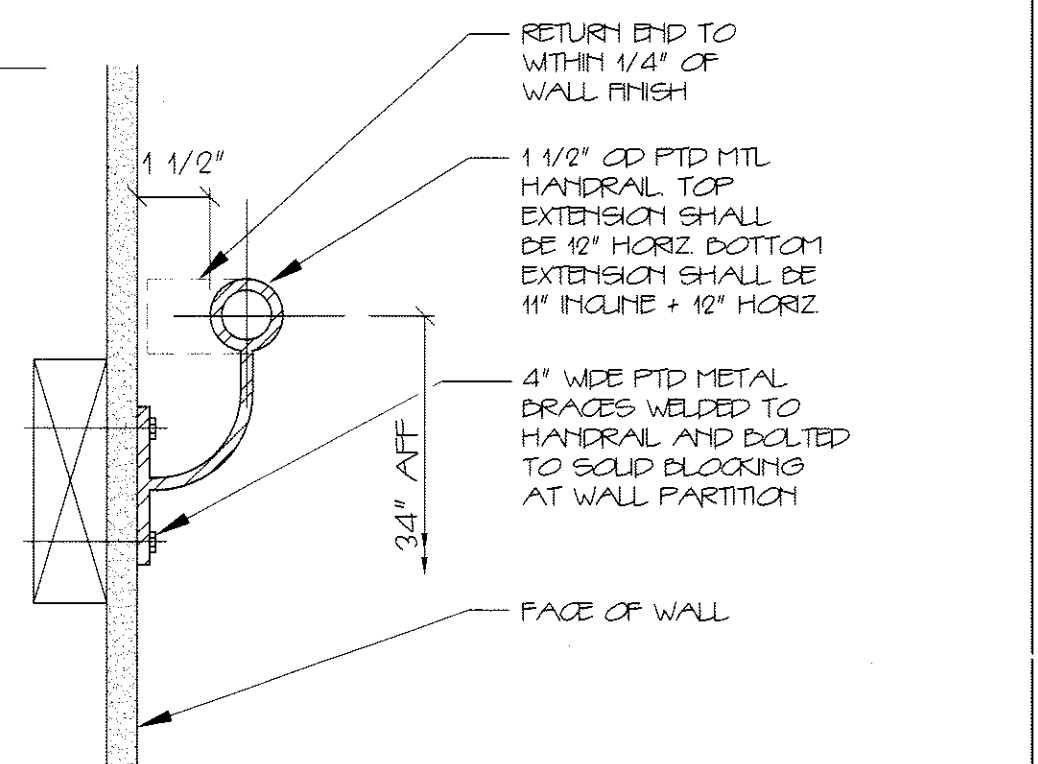

NR CLEARANCES/ MOUNTING HEIGHT
HANDRAIL LOCATIONS

Date: 09/15/14



1 TYPICAL WALL HANDRAIL SECTION 3/4"=1'-0"

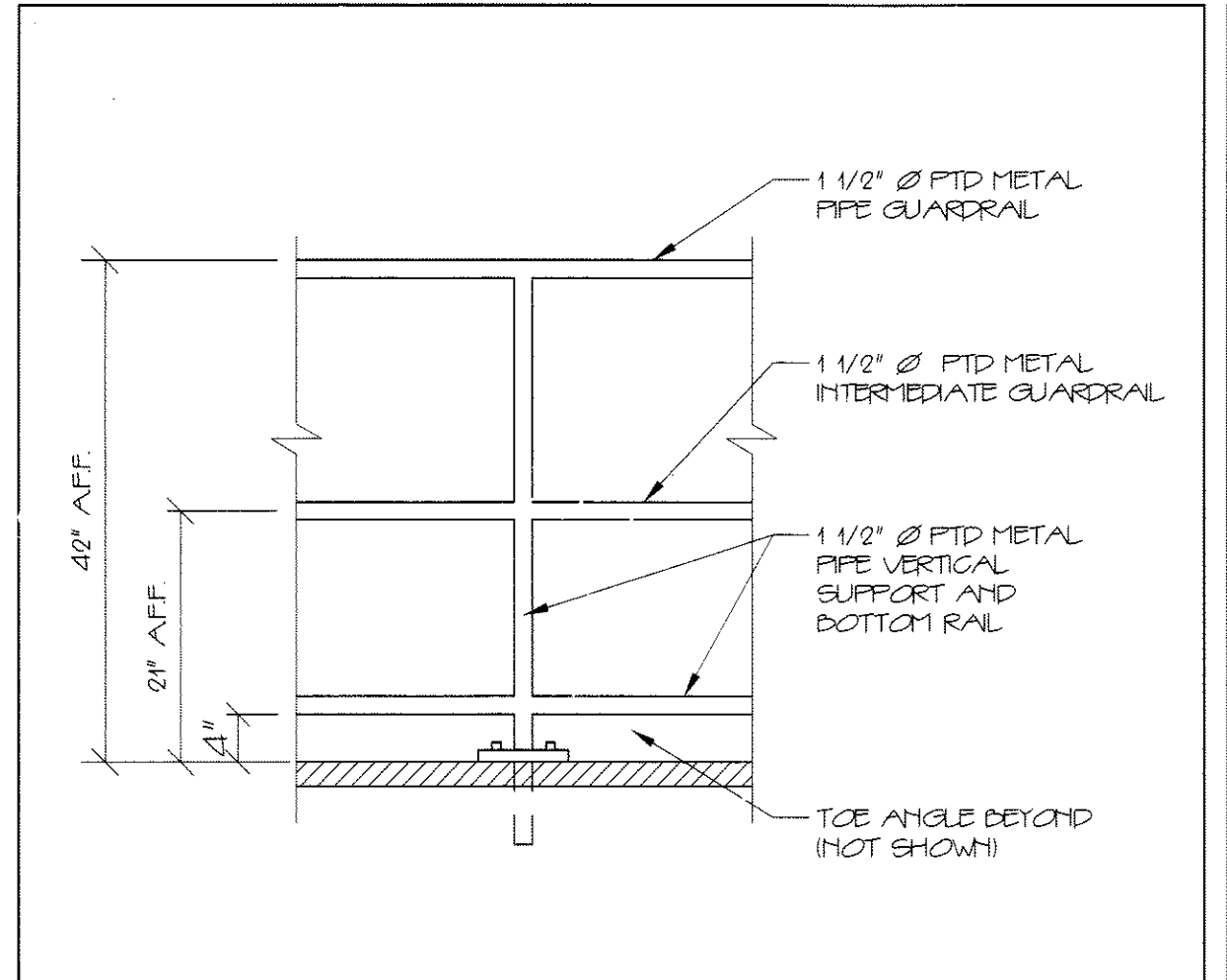

2 TYPICAL GUARDRAIL 3/4"=1'-0"

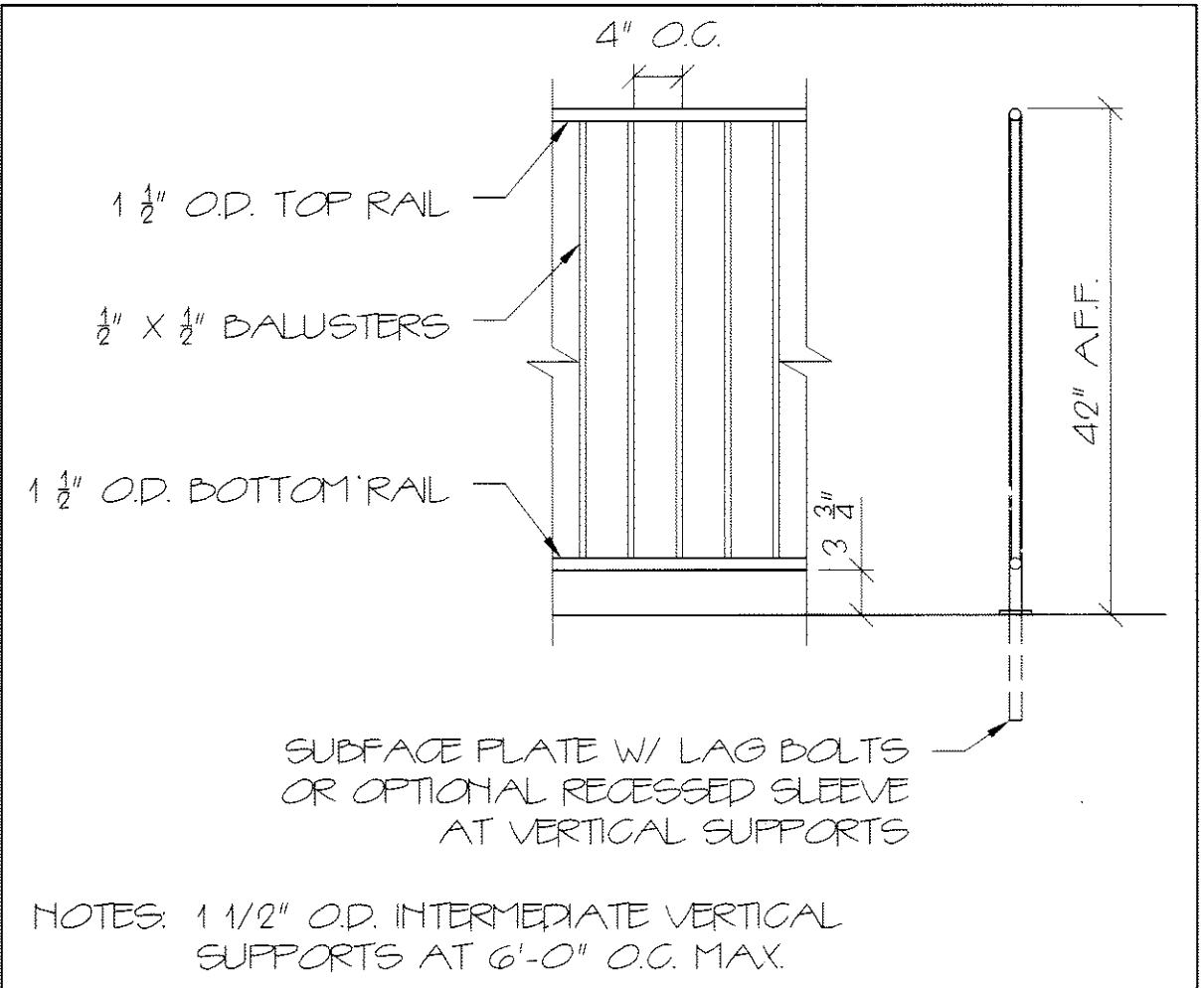

3 TYPICAL EXTERIOR GUARDRAIL N.T.S.

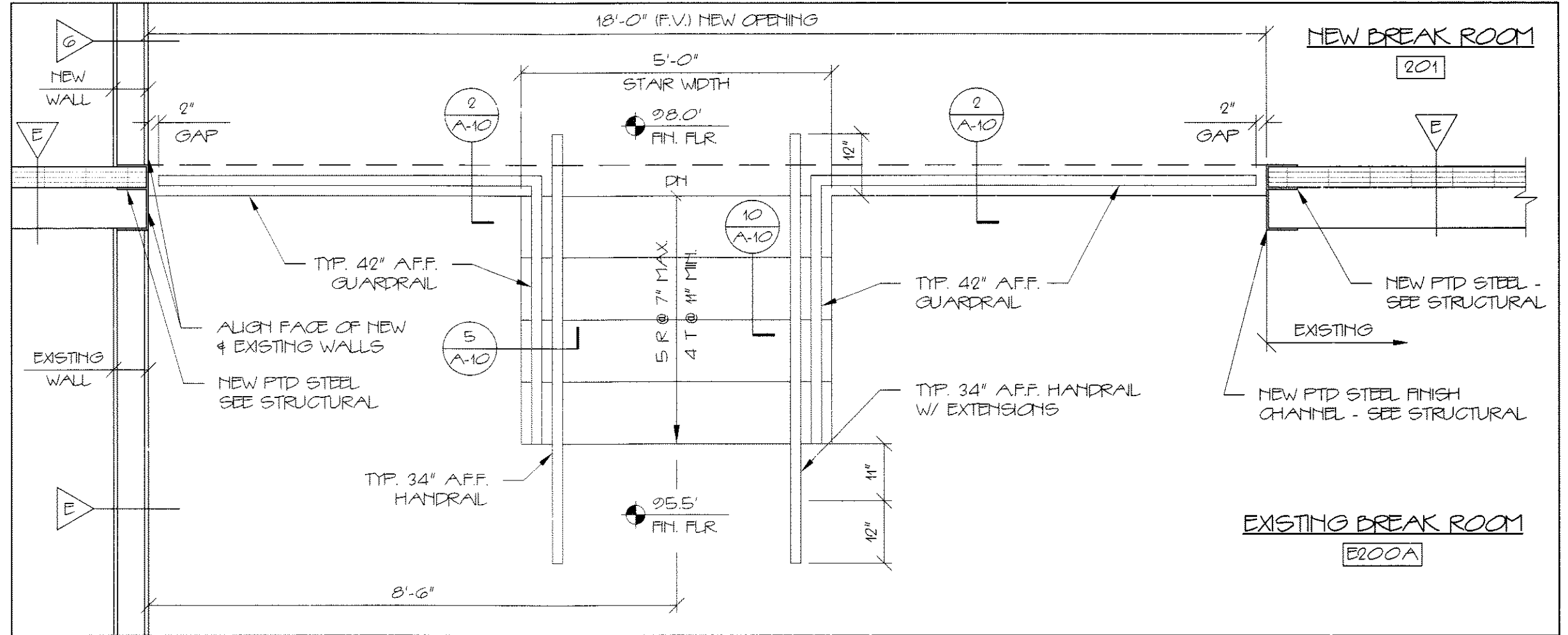

A STAR PLAN AT BREAK ROOMS 1/2"=1'-0"

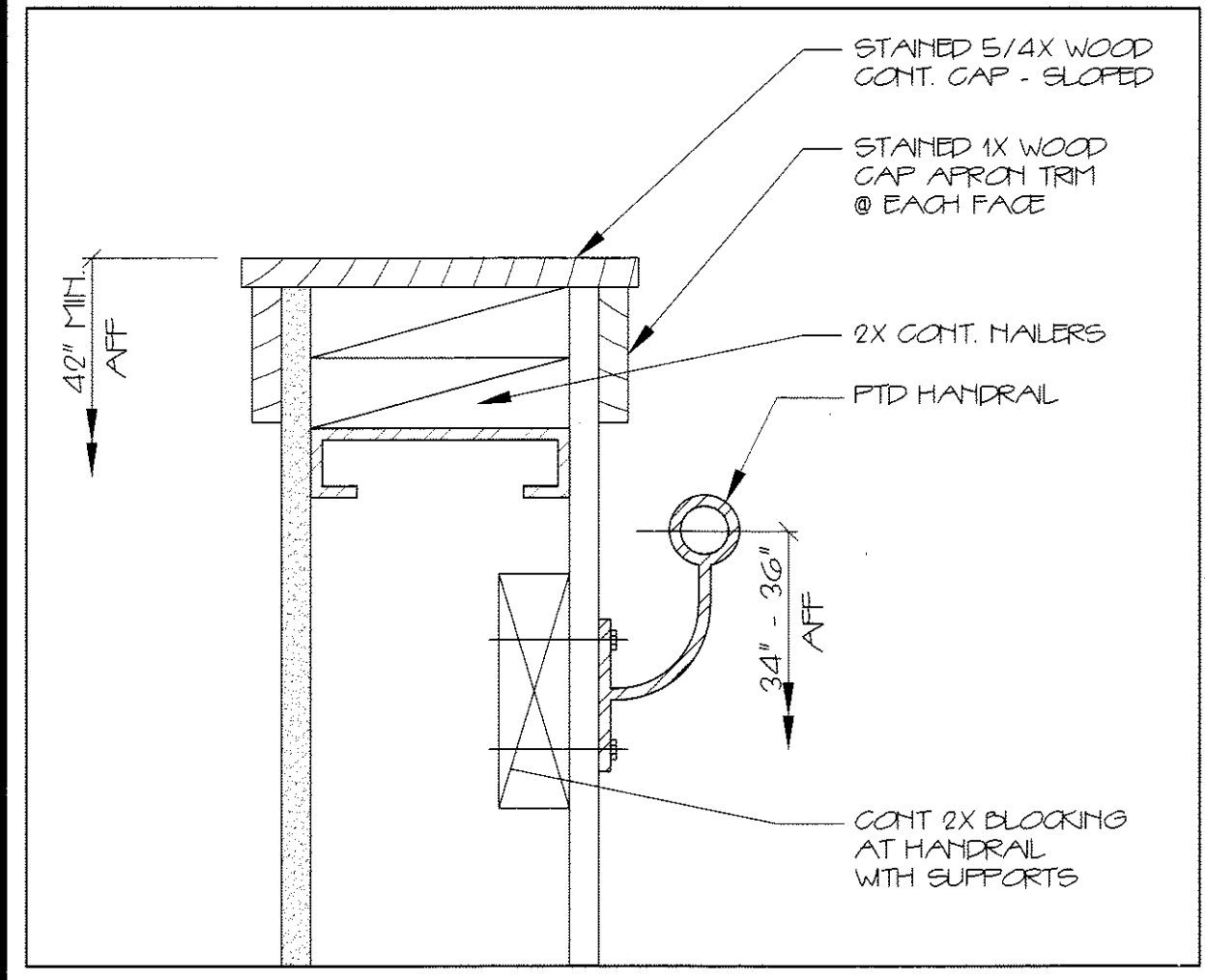

4 STAIR GUARDRAIL 3/4"=1'-0"

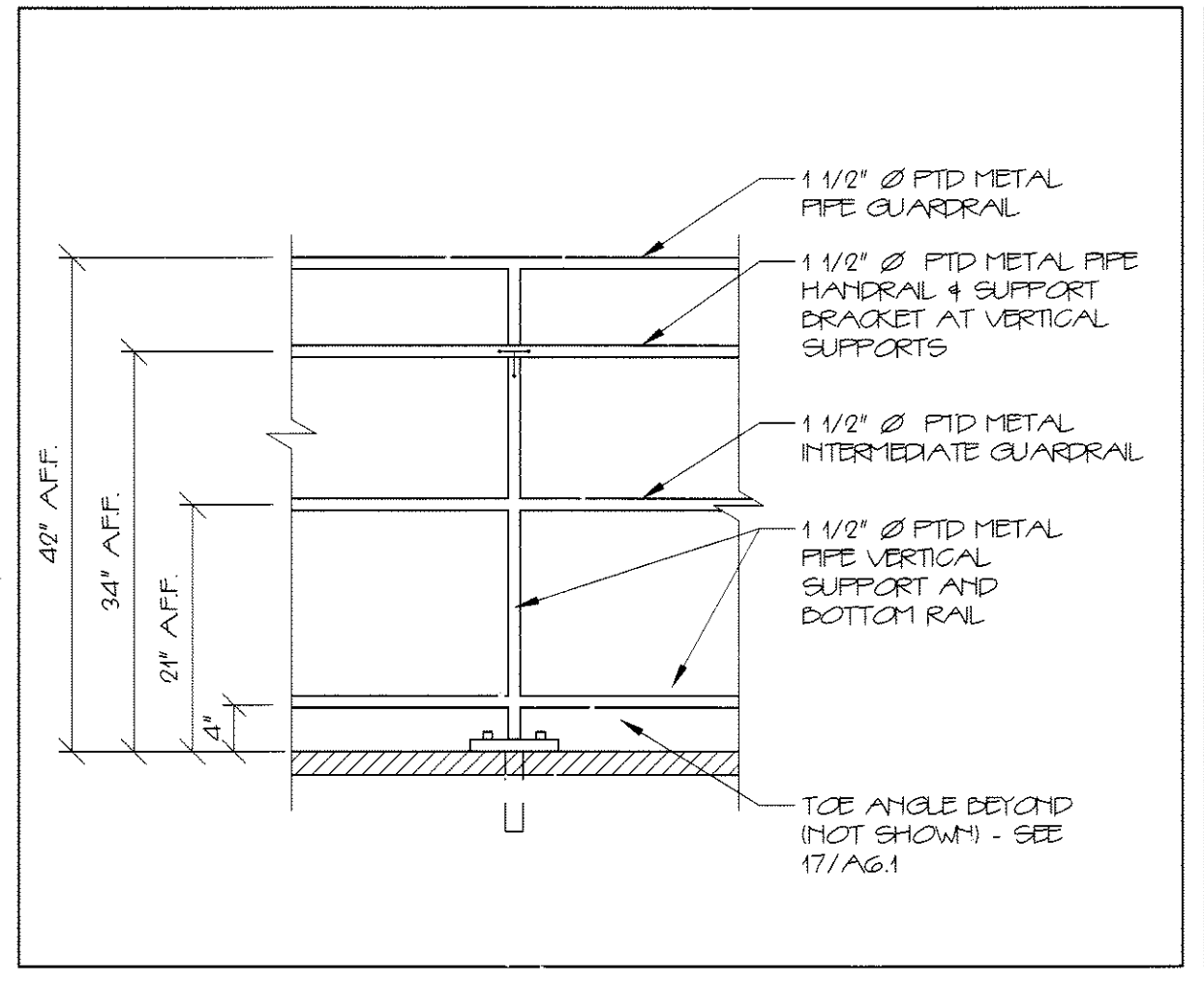

5 TYPICAL GUARDRAIL/HANDRAIL 3/4"=1'-0"

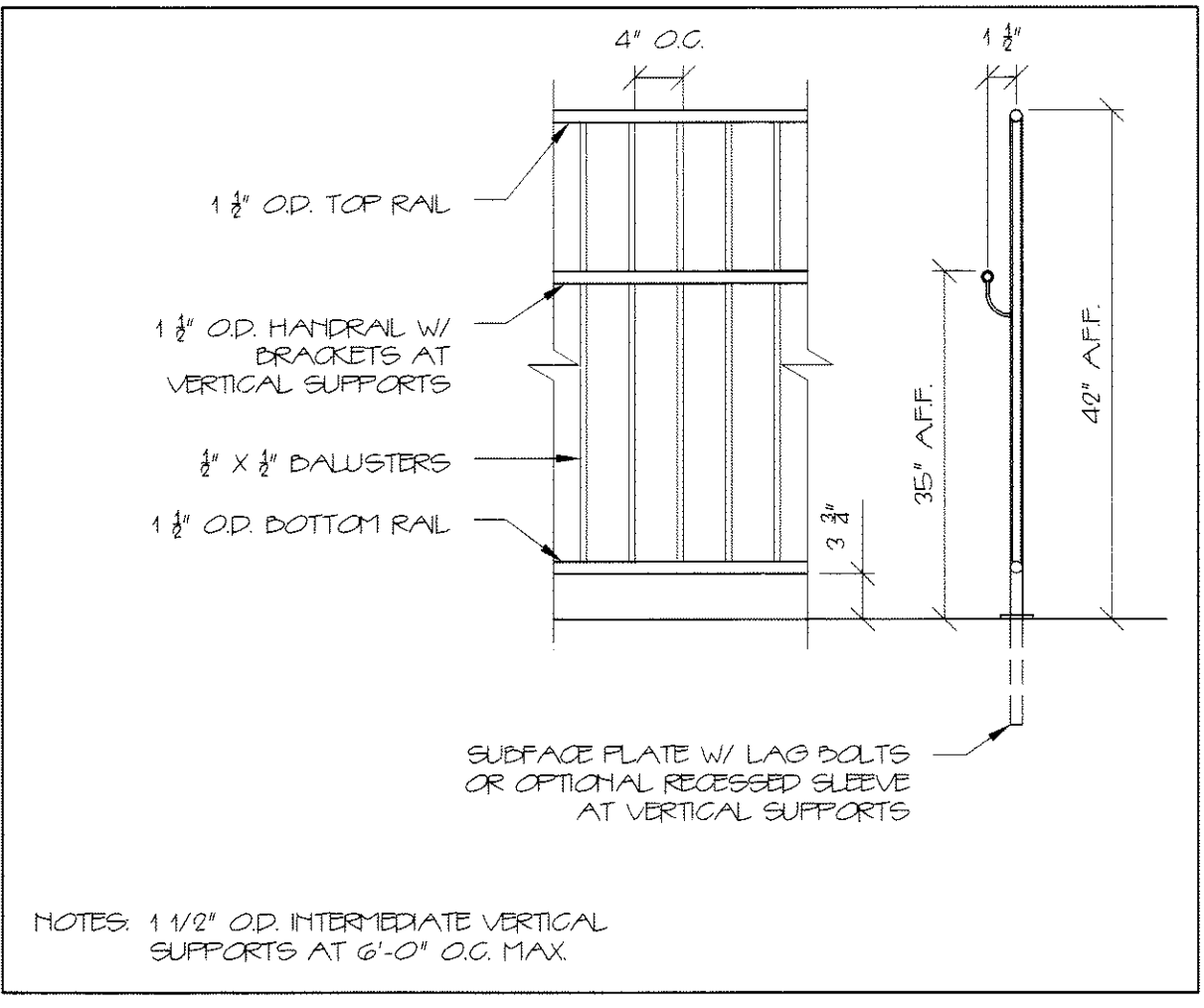

6 EXTERIOR GUARDRAIL/HANDRAIL 3/4"=1'-0"

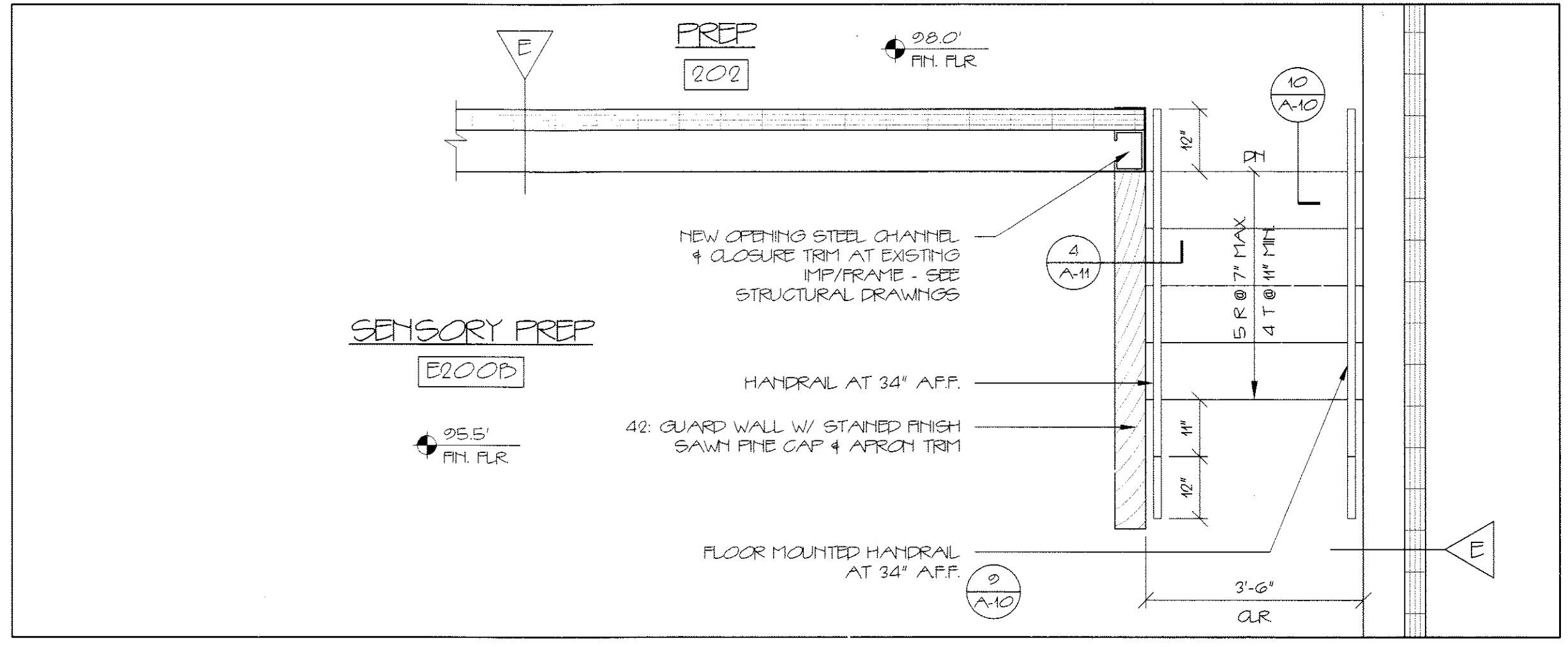

B STAR PLAN AT SENSORY PREP 1/2"=1'-0"

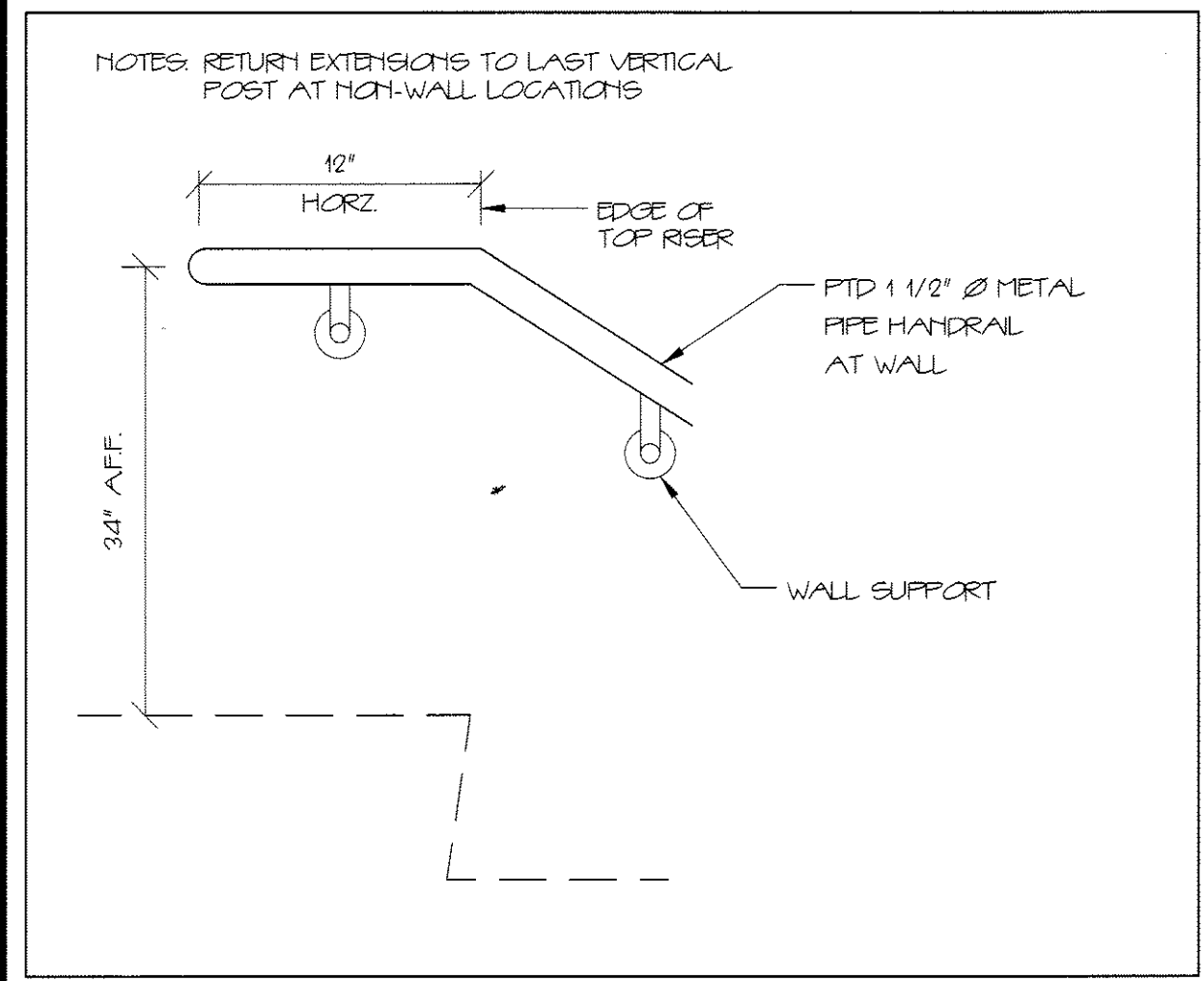

7 TYPICAL WALL HANDRAIL - BOTTOM 1 1/2"=1'-0"

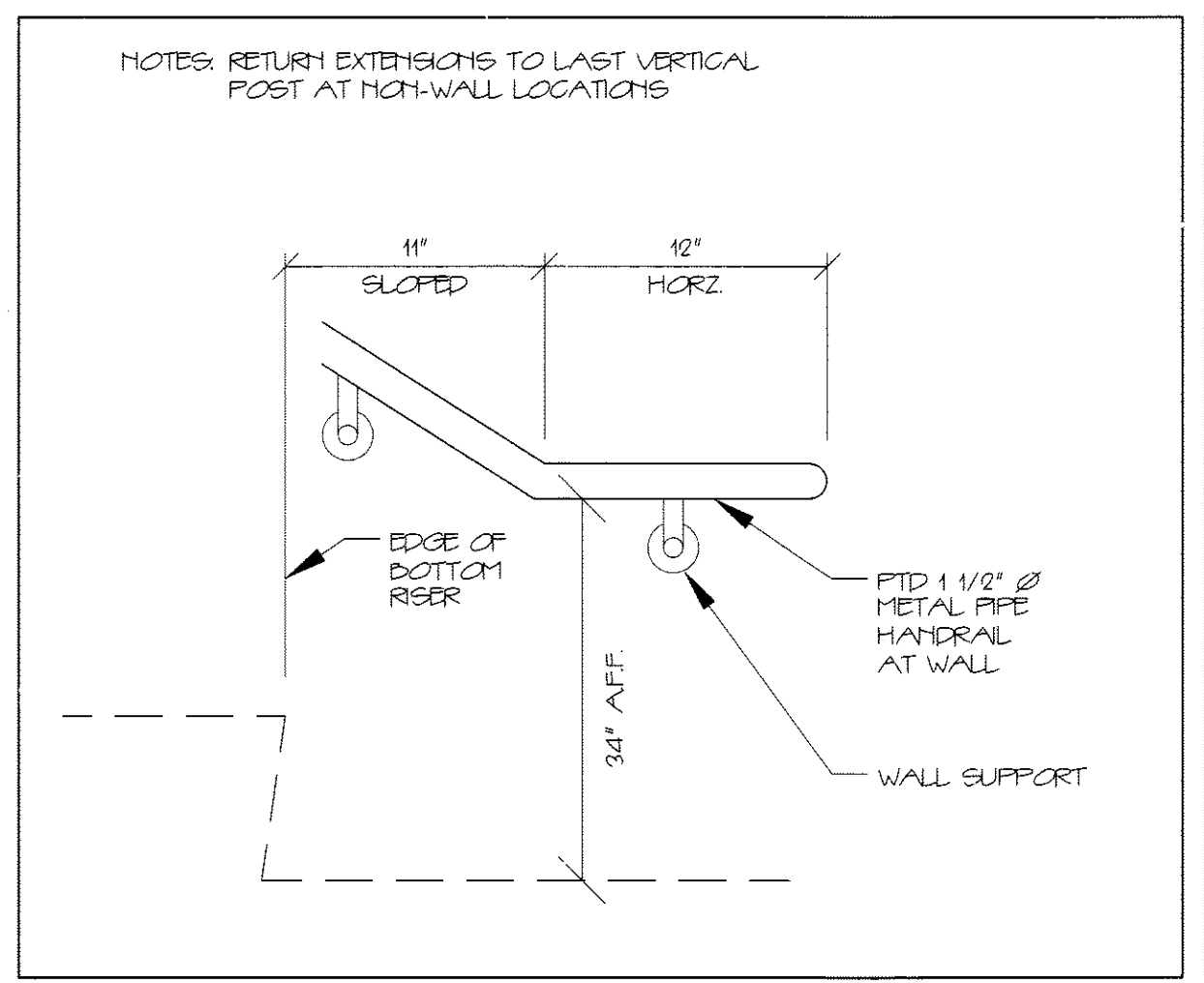

8 TYPICAL WALL HANDRAIL - BOTTOM 1 1/2"=1'-0"

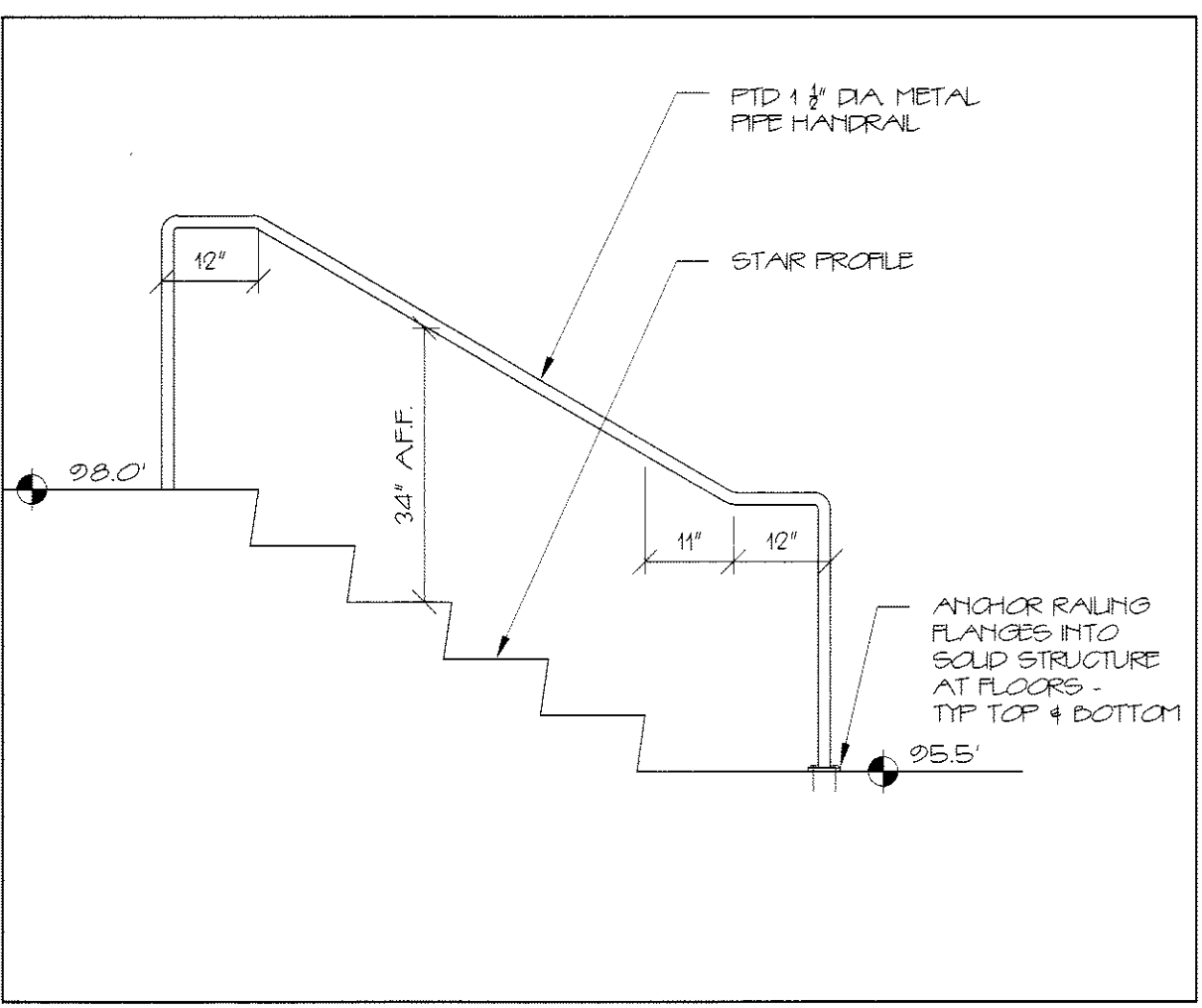

9 FLOOR MOUNTED HANDRAIL 1/2"=1'-0"

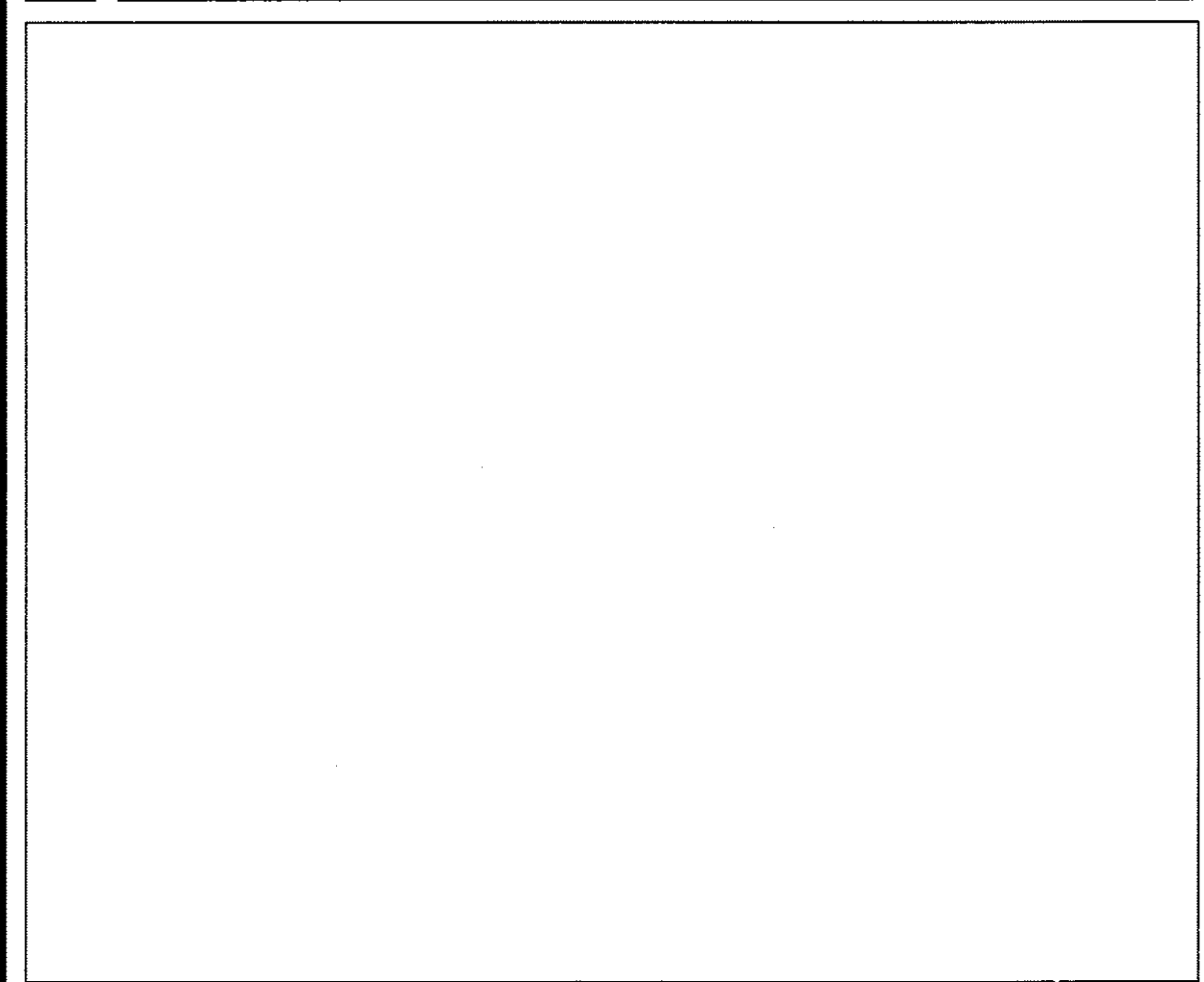

C STAIR PLAN AT EXTERIOR - PRODUCTION AREA 1/2"=1'-0"

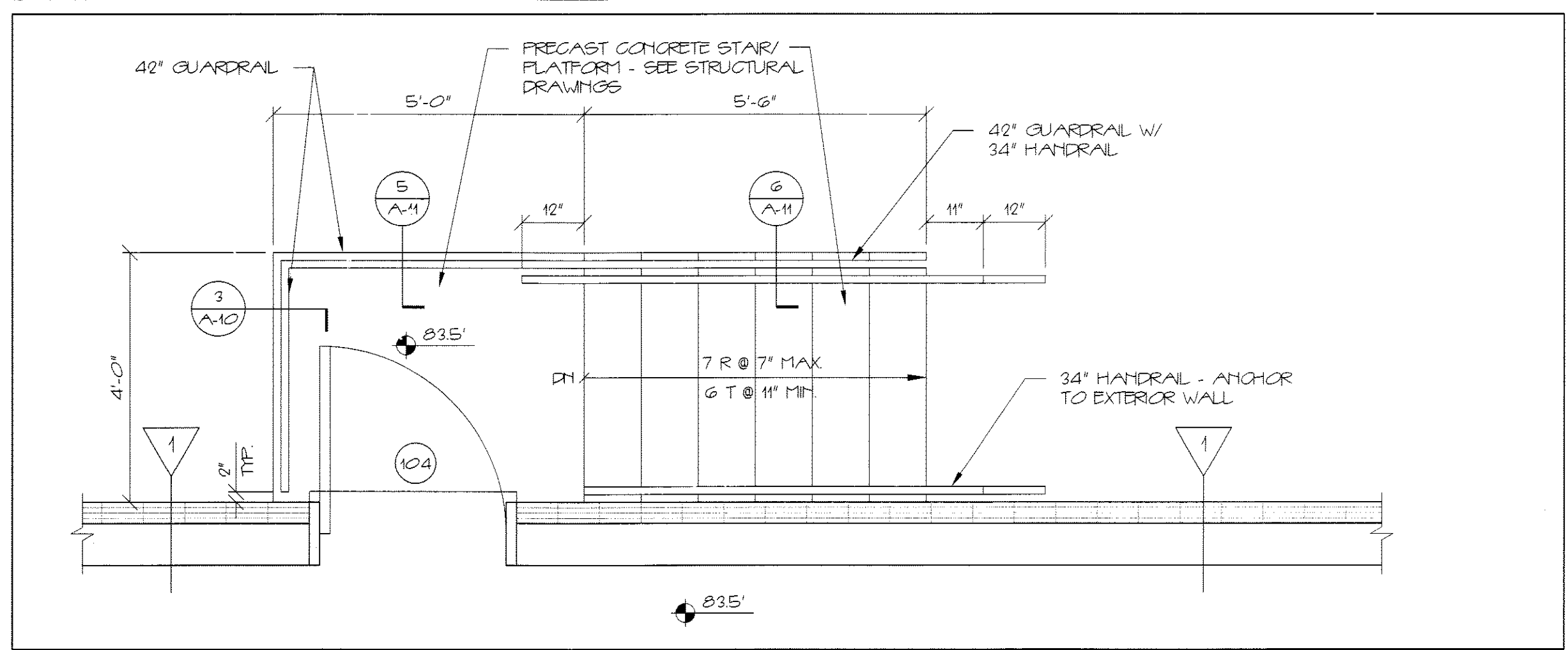

D STAR PLAN AT EXTERIOR/GATWALK 1/2"=1'-0"

REPRODUCTION OR MISUSE OF THIS DOCUMENT WITHOUT WRITTEN PERMISSION FROM GRANT HAYS ASSOCIATES IS PROHIBITED.

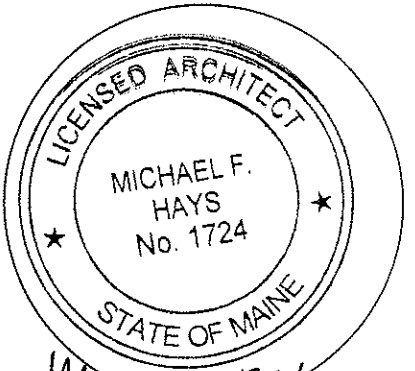

REVISIONS

NEW ADDITION FOR
ALLAGASH BREWING CO.
50 INDUSTRIAL WAY PORTLAND, MAINE

GRANT HAYS
ARCHITECTURE
INTERIOR DESIGN
P.O. BOX 6179 FALMOUTH, MAINE 04105
TEL: 871-5900 (207) 871-9308

DRAWING TITLE
STAIRS

SCALE AS NOTED
DATE 7/25/2014
DRAWN BY SAM/MPH
JOB NO. 140560
DRAWING NO.

A-11