

FireWarden-100-2(E) Rev 3

Intelligent Addressable FACP



Addressable Fire Alarm Control Panel

General

The Notifier FireWarden-100-2 Rev 3 (NFW2-100) with Version 5.0 firmware is a combination FACP (Fire Alarm Control Panel) and DACT (Digital Alarm Communicator/Transmitter) all on one circuit board. This compact intelligent addressable control panel has an extensive list of powerful features.

The SLC (Signaling Line Circuit) of the FireWarden-100-2 Rev 3 operates using a Rapid Group Polling communication protocol technology that polls multiple devices simultaneously for a quicker device response time. This patented technology allows a fully-loaded panel with up to 198 devices to report an incident and activate the notification circuits in under 10 seconds. With this improved polling, devices can be wired on standard twisted, unshielded wire up to a distance of 10,000 feet.

The 's quick-remove chassis protects the electronics during construction. The backbox can be installed allowing field wiring to be pulled. When construction is completed, the electronics can be quickly installed with just two bolts.

New features for Rev 3 with Version 5.0 firmware include removable terminal blocks, improved transient protection, additional secondary ANN-BUS, and increased power for the resettable and remote sync outputs.

Available accessories include ANN-BUS devices as well as ACS LED, graphic and LCD annunciators, and reverse polarity/city box transmitter.

The integral DACT transmits system status (alarms, supervisories, troubles, AC loss, etc.) to a Central Station via the public switched telephone network. It also allows remote and local programming of the control panel using the PS-Tools Upload/Download utility. In addition, the control panel may be programmed or interrogated off-site via the public switched telephone network. Any personal computer with Windows® XP or greater, a compatible modem, and PS-Tools—the Upload/Download software kit—may serve as a Service Terminal. This allows download of the entire program or upload of the entire program, history file, walktest data, current status and system voltages. The panel can also be programmed through the FACP's keypad or via a standard PS-2 computer keyboard, which can be plugged directly into the printed circuit board. This permits easy typing of address labels and other programming information.

Version 5.0 firmware supports the following: Primary and Secondary ANN-bus devices, NP-A100, USB port, NAC circuit diagnostics, a new report has been added to the walk-test that lists untested devices, new device types added: audio telephone type code for NFV-25/50ZST, Photo Supervisory and auto-resettable Drill (non-latching).

The FireWatch Series internet monitoring modules IPDACT-2 and IPDACT-2UD permit monitoring of alarm signals over the Internet saving the monthly cost of two dedicated business telephone lines. Although not required, the secondary telephone line may be retained providing backup communication over the public switched telephone line.

NOTE: Unless otherwise specified, the term "FireWarden-100-2" is used in this document to refer to both the FireWarden-100-2 and the FireWarden-100-2E FACP's (Fire Alarm Control Panels). Likewise, "NFW2-100" refers to NFW2-100E as well.

Features

- Listed to UL standard 864, 9th edition.
- On-board DACT.

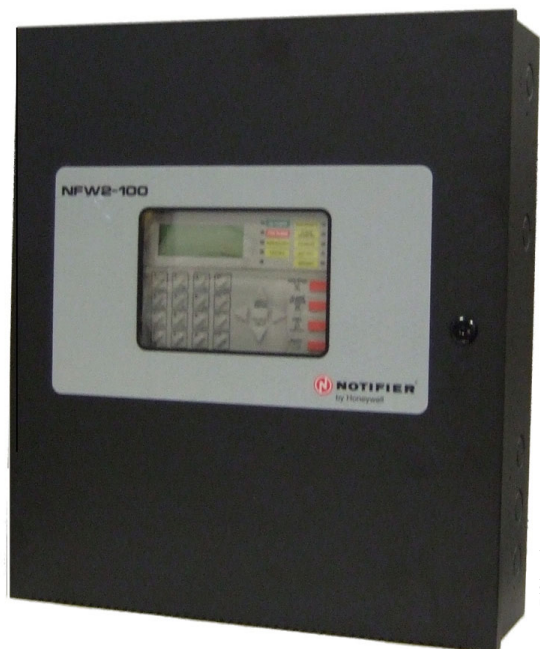

- Remote site or local USB port upload/download, using PS-Tools.
- Four (4) Style Y (Class B) NAC circuits, which can be converted to four (4) Style Z (Class A) circuits with optional ZNAC-92 converter module. (Up to 6.0 amps total NAC power when using optional XRM-24B.)
- Selectable strobe synchronization for System Sensor, Wheelock, and Gentex devices.
- Remote Acknowledge, Silence, Reset and Drill via addressable monitor modules or FDU-80, N-ANN-80 or Legacy ACS Annunciators.
- ANN-BUS for connection to following optional modules (cannot be used if ACS annunciators are used):
 - N-ANN-80(-W) Remote LCD Annunciator
 - N-ANN-I/O LED Driver
 - N-ANN-S/PG Printer Module
 - N-ANN-RLY Relay Module
 - N-ANN-LED Annunciator Module
 - N-ANN-RLED Annunciator Module alarms only
 - ROME Relay Option Module Enclosure
- ACS & Terminal-mode Annunciators:
 - ACS Annunciators: Up to 32 Legacy ACM Series annunciators (ACM-16AT or ACM-32 series). Cannot be used if ANN-BUS devices are used.
 - Terminal-mode Annunciators: Up to 32 Legacy FDU-80 annunciators.
- EIA-232 printer/PC interface (variable baud rate) on main circuit board, for use with optional UL-listed printer PRN-6.
- Integral 80-character LCD display with backlighting.
- Real-time clock/calendar with automatic daylight savings control.
- Detector sensitivity test capability (NFPA 72 compliant).

- History file with 1,000-event capacity.
- Maintenance alert warns when smoke detector dust accumulation is excessive.
- Automatic device type-code verification.
- One person audible or silent walk test with walk-test log and printout.
- Point trouble identification.
- Waterflow (nonsilenceable) selection per monitor point.
- System alarm verification selection per detector point.
- PAS (Positive Alarm Sequence) and presignal delay per point (NFPA 72 compliant).

NOTE: Only detectors may participate in PAS.

SLC LOOP:

- SLC can be configured for NFPA Style 4, 6, or 7 operation.
- SLC supports up to 198 addressable devices per loop (99 detectors and 99 monitor, control, or relay modules).
- SLC loop maximum length 10,000 ft. (3,000 m.).
See installation manual for wire tables.

NOTIFICATION APPLIANCE CIRCUITS (NACS):

- Four onboard NACs with additional NAC capability using output control modules (NC-100). The four Class B NACs can be converted to four Class A NACs with optional ZNAC-92 converter module.
- Silence Inhibit and Auto Silence timer options.
- Continuous, March Time, Temporal or California code for main circuit board NACs with two-stage capability.
- Selectable strobe synchronization per NAC.
- 2.5 amps maximum per each NAC circuit.

NOTE: Maximum 24VDC system power output is shared among all NAC circuits and 24VDC special-application auxiliary power outputs. Total available output is 3.0 amps. Using the optional XRM-24B transformer increases 24VDC output to 6.0 amps.

PROGRAMMING AND SOFTWARE:

- Autoprogram (learn mode) reduces installation time.
- Custom English labels (per point) may be manually entered or selected from an internal library file.
- Three Form-C relay outputs (two programmable).
- 99 software zones.
- Continuous fire protection during online programming at the front panel.
- Program Check automatically catches common errors not linked to any zone or input point.
- **OFFLINE PROGRAMMING:** Create the entire program in your office using a Windows®-based software package (NFW2-100 requires PS-Tools Programming software, available on www.magni-fire.com). Upload/download system programming locally to the NFW2-100 Rev 3 in less than one minute.
- USB upload/download programming with standard Male-A to Male-B cable.

User Interface

LED INDICATORS

- AC Power (green)
- Fire Alarm (red)
- Supervisory (yellow)
- Alarm Silenced (yellow)
- System Trouble (yellow)
- Maintenance/Presignal (yellow)
- Disabled (yellow)
- Battery Fault (yellow)

- Ground Fault (yellow)

KEYPAD CONTROLS

- Acknowledge/Step
- Alarm Silence
- Drill
- System Reset (lamp test)
- 16-key alpha-numeric pad (similar to telephone keypad)
- 4 cursor keys
- Enter

Product Line Information

NFW2-100: FireWarden-100-2 Rev 3 198-point addressable Fire Alarm Control Panel, one SLC loop. Includes 80-character LCD display, single printed circuit board mounted on chassis, and cabinet. 120 VAC operation.

NFW2-100R: Same as **NFW2-100**, except in a red backbox.

NFW2-100E: Same as **NFW2-100**, except with 240 VAC operation.

4XTM Reverse Polarity Transmitter Module: Provides supervised output for local energy municipal box transmitter, alarm, and trouble.

ZNAC-92: Optional converter module which converts four (4) Style Y (Class B) NAC circuits to four (4) Style Z (Class A) circuits.

PS Tools: Programming software for Windows®-based PC computer (cable not included), available on www.firelite.com.

DP-9692B: Optional dress panel for FireWarden-100-2 Rev 3.

TR-CE-B: Optional trim Ring for semi-flush mounting.

BB-26: Battery backbox, holds up to two 26 AH batteries and CHG-75.

NFS-LBB: Battery box, houses two 55 AH batteries.

CHG-75: Battery charger for lead-acid batteries with a rating of 25 to 75 AH.

CHG-120: Remote battery charging system for lead-acid batteries with a rating of 55 to 120 AH. Requires additional NFS-LBB for mounting.

NOTE: CHG-120 or CHG-75 required for batteries larger than 18AH.

BAT Series: Batteries, see data sheet DN-6933.

XRM-24B(E): Optional transformer. Increases system power output to 6.0 amps. Use XRM-24BE with FireWarden-100-2E Rev 3.

PRT/PK-CABLE: Cable printer/personal computer interface cable; required for printer or for local upload/download programming and updating panel firmware.

PRN-6: UL listed compatible event printer. Uses tractor-fed paper.

IPDACT-2/2UD, IPDACT Internet Monitoring Module: Mounts in bottom of enclosure with optional mounting kit (PN IPBRKT). Connects to primary and secondary DACT telephone output ports for internet communications over customer provided ethernet internet connection. Requires compatible Teldat VisorALARM Central Station Receiver. Can use DHCP or static IP. (*See data sheet DN-60408 for more information.*)

IPBRKT: Mounting kit for IPDACT-2/2UD in common enclosure.

IPSPLT: Y-adaptor option allows connection of both panel dialer outputs to one IPDACT-2/2UD cable input.

COMPATIBLE ANNUNCIATORS

N-ANN-80(-W): LCD Annunciator is a remote LCD annunciator that mimics the information displayed on the FACP LCD display. Recommended wire type is un-shielded. (Basic model is black; order -W version for white; see DN-7114.)

N-ANN-LED: Annunciator Module provides three LEDs for each zone: Alarm, Trouble and Supervisory. Ships with red or black enclosure (see DN-60242).

N-ANN-RLED: Provides alarm (red) indicators for up to 30 input zones or addressable points. (See DN-60242).

N-ANN-RLY: Relay Module, which can be mounted inside the cabinet, provides 10 programmable Form-C relays. (See DN-7107.)

ROME-B: Relay Option Module Enclosure (order ROME-B for black or ROME for red). Provides one **N-ANN-RLY** Relay Module already installed. The ROME Series provides mounting space for one additional Relay Module or one addressable Multi-module. (See *Installation Sheet PN 53530*.)

N-ANN-S/PG: Serial/Parallel Printer Gateway module provides a connection for a serial or parallel printer. (See DN-7103.)

N-ANN-I/O: LED Driver Module provides connections to a user supplied graphic annunciator. (See DN-7105.)

ACM-8R: Relay module provides 8 Form-C 5.0 amp relays.

ACM Annunciator Series: LED-type fire annunciators capable of providing up to 99 software zones of annunciation. Available in increments of 16 or 32 points to meet a variety of applications.

LDM Graphic Series: Lamp Driver Module series for use with custom graphic annunciators.

FDU-80 (Liquid Crystal Display) point annunciator: 80-character, backlit LCD-type fire annunciators capable of displaying English-language text.

NOTE: For more information on Compatible Annunciators for use with the FireWarden-100-2 Rev 3, see the following data sheets (document numbers) *ACM-8R (DN-3558)*, *ACS/ACM Series (DN-0524)*, *LDM Series (DN-0551)*, *FDU-80 (DN-6820)*.

COMPATIBLE ADDRESSABLE DEVICES

All feature a polling LED and rotary switches for addressing.

NI-100: Addressable low-profile ionization smoke detector.

NP-100: Addressable low-profile photoelectric smoke detector.

NP-100T: Addressable low-profile photoelectric smoke detector with thermal sensor.

NP-100R: Addressable remote test capable detector for use with DNR(W) duct smoke detector housings.

NH-100: Fast-response, low-profile heat detector.

NH-100R: Fast-response, low-profile heat detector with rate-of-rise option.

NH-100H: Fixed high-temperature detector that activates at 190F/88C.

NP-A100: Addressable low-profile multi-sensor detector.

DNR: Innovair Flex low-flow non-relay duct-detector housing. Order NP-100R separately.

DNRW: Innovair Flex low-flow non-relay duct-detector housing, with NEMA-4 rating. Watertight. (Order NP-100R separately.)

NMM-100: Addressable Monitor Module for one zone of normally-open dry-contact initiating devices. Mounts in standard 4.0" (10.16 cm.) box. Includes plastic cover plate and end-of-line resistor. Module may be configured for either a Style B (Class B) or Style D (Class A) IDC.

NDM-100: Dual Monitor Module. Same as NMM-100 except it provides two Style B (Class B) only IDCs.

NMM-100P: Miniature version of NMM-100. Excludes LED and Style D option. Connects with wire pigtailed. May mount in device backbox.

NZM-100: Similar to NMM-100, but may monitor up to 20 conventional two-wire detectors. Requires resettable 24 VDC power. Consult factory for compatible smoke detectors.

NC-100: Addressable Control Module for one Style Y/Z (Class B/A) zone of supervised polarized Notification Appliances. Mounts directly to a 4.0" (10.16 cm.) electrical box. Notification

Appliance Circuit option requires external 24 VDC to power notification appliances.

NC-100R: Addressable relay module containing two isolated sets of Form-C contacts, which operate as a DPDT switch. Mounts directly to a 4.0" (10.16 cm.) box, surface mount using the SMB500.

NOT-BG12LX: Addressable manual pull station with interface module mounted inside.

N100-ISO: Fault Isolator Module. This module isolates the SLC loop from short circuit conditions (required for Style 6 or 7 operation).

SMB500: Used to mount all modules except the NMM-100P.

NMM-100-10: Ten-input monitor module. Mount one or two modules in a BB-XP cabinet (optional). Mount up to six modules on a CHS-6 chassis in a BB-25.

NZM-100-6: Six-zone interface module for compatible conventional two-wire detectors. Mount one or two modules in a BB-XP cabinet (optional). Mount up to six modules on a CHS-6 chassis in a BB-25.

NOTE: For more information on Compatible Addressable Devices for use with the FireWarden-100-2 Rev 3, see the following data sheets (document numbers): *N100-ISO (DN-6994)*, *NP-100 series (DN-6995)*, *NI-100 (DN-6996)*, *NH-100 series (DN-6997)*, *ND-100 series (DN-7006)*, *NP-A100 (DN-6998)*, *NMM-100/NMM-100P/NDM-100/NZM-100 (DN-6999)*, *NC-100/NC-100R (DN-7000)*, *NOT-BG12LX (DN-7001)*, *NMM-100-10 (DN-6990)*, and *NZM-100-6 (DN-60150)*.

Wiring Requirements

While shielded wire is not required, it is recommended that all SLC wiring be twisted-pair to minimize the effects of electrical interference. Wire size should be no smaller than 18 AWG (0.78 mm²) and no larger than 12 AWG (3.1 mm²). The wire size depends on the length of the SLC circuit. Refer to the panel manual for wiring details.

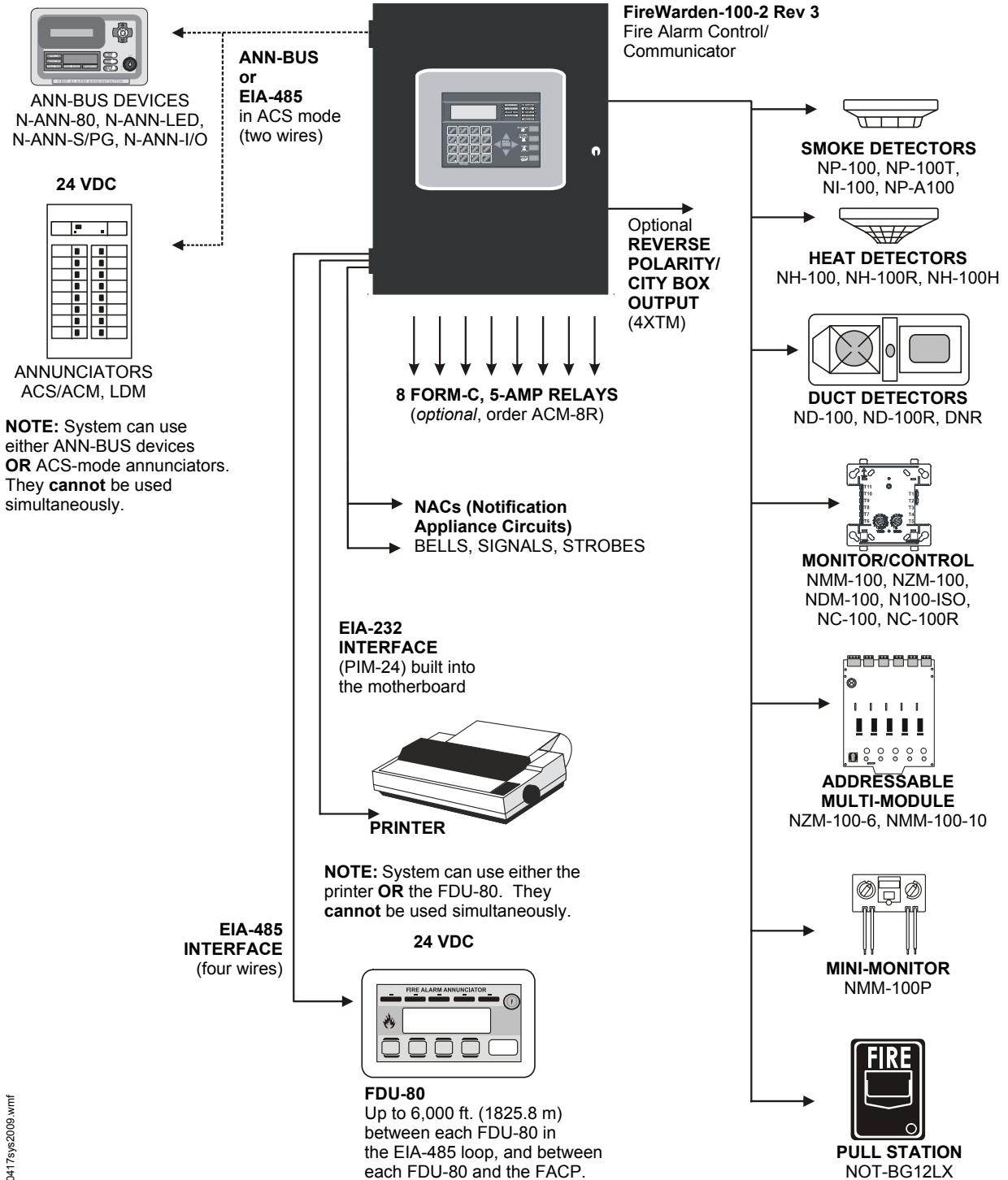

60417sys2009.wmf

SYSTEM SPECIFICATIONS

System Capacity

- Intelligent Signalling Line Circuits..... 1
- Addressable device capacity 198
- Programmable software zones 99
- ACS Annunciators 32
- ANN-bus devices 16

Electrical Specifications

AC Power: FireWarden-100-2 Rev 3: 120 VAC, 60 Hz, 3.0 amps. FireWarden-100-2 Rev 3(E): 240 VAC, 50 Hz, 1.5 amps. Wire size: minimum 14 AWG (2.00 mm²) with 600 V insulation.

Battery charger capacity: 7 AH - 18 AH batteries. Up to two 18 Ah batteries can be housed in the FACP cabinet. Larger batteries require an external battery charger such as the CHG-75 or CHG-120, and a separate battery cabinet such as the BB-26 or NFS-LBB.

Communication Loop: Supervised and power-limited.

Notification Appliance Circuits: Each terminal block provides connections for two Style Y (Class B) for a total of four Style Y (Class B) or with an optional ZNAC-92 module converts to four Style Z (Class A) NACs. Maximum signaling current per circuit: 2.5 amps. End-of-Line Resistor: 4.7K ohm, 1/2 watt (P/N 71252 UL listed) for Style Y (Class B) NAC. Refer to panel documentation and *Notifier Device Compatibility Document* for listed compatible devices.

Two Programmable Relays and One Fixed Trouble Relay: Contact rating: 2.0 amps @ 30 VDC (resistive), 0.5 amps @ 30 VAC (resistive). Form-C relays.

Special Application Non-resettable Power (24 VDC Nominal): Jumper selectable (JP4) for conversion to resettable power output. Up to 1.0 amp total DC current available from each output. Power-limited.

Special Application Resettable Power (24 VDC nominal): Jumper selectable (JP6) for conversion to non-resettable power. Up to 1.0 amp total DC current available. Refer to the *Notifier Device Compatibility Document* for listed compatible devices.

Remote Sync Output: Remote power supply synchronization output. Nominal special application power: 24 VDC. Maximum current: 300 mA. End-of-Line Resistor: 4.7K ohm. Output linked to NAC 1 control. Supervised and power-limited.

Telephone Interface: Unless used with Teldat VISORALARM, requires dedicated business telephone number with a minimum of 5 volts DC (off-hook voltage). Obtain dedicated phone line directly from your local phone company. Do not use shared phone lines or PBX (digital) type phone line extensions.

Cabinet Specifications

Door: 19.26" (48.92 cm.) high x 16.82" (42.73 cm.) wide x 0.12" (.30 cm.) deep. **Backbox:** 19.00" (48.26 cm.) high x 16.65"

(42.29 cm.) wide x 5.20" (13.34 cm.) deep. **Trim Ring (TR-CE-B):** 22.00" (55.88 cm.) high x 19.65" (49.91 cm.) wide.

Shipping Specifications

Weight: 26.9 lbs. (12.20 kg.) **Dimensions:** 20.00" (50.80 cm.) high x 22.5" (57.15 cm.) wide x 8.5" (21.59 cm.) deep.

Temperature and Humidity Ranges

This system meets NFPA requirements for operation at 0 – 49°C/32 – 120°F and at a relative humidity 93% ± 2% RH (non-condensing) at 32°C ± 2°C (90°F ± 3°F). However, the useful life of the system's standby batteries and the electronic components may be adversely affected by extreme temperature ranges and humidity. Therefore, it is recommended that this system and its peripherals be installed in an environment with a normal room temperature of 15 – 27°C/60 – 80°F.

NFPA Standards

The FireWarden-100-2 Rev 3 complies with the following NFPA 72 Fire Alarm Systems requirements:

- **LOCAL** (Automatic, Manual, Waterflow and Sprinkler Supervisory).
- **AUXILIARY** (Automatic, Manual and Waterflow) (requires 4XTM).
- **REMOTE STATION** (Automatic, Manual, Waterflow and Sprinkler Supervisory) (Where a DACT is not accepted, the alarm, trouble and supervisory relays may be connected to UL 864 listed transmitters. For reverse polarity signaling of alarm and trouble, 4XTM is required.)
- **PROPRIETARY** (Automatic, Manual, Waterflow and Sprinkler Supervisory).
- **CENTRAL STATION** (Automatic, Manual, Waterflow and Sprinkler Supervisory).
- **OT, PSDN** (Other Technologies, Packet-switched Data Network)

Agency Listings and Approvals

The listings and approvals below apply to the basic FireWarden-100-2 Rev 3 control panel. In some cases, certain modules may not be listed by certain approval agencies, or listing may be in process. Consult factory for latest listing status.

- **UL Listed:** S635
- **FM approved**
- **CSFM:** 7165-0028:0235
- **MEA:** 120-06-E, Volume 2

For ULC-listed version, see DN-60600.

NOTIFIER® is a registered trademark of Honeywell International Inc. Wheelock® is a registered trademark of and Exceder™ is a trademark of Cooper Notification.

©2010 by Honeywell International Inc. All rights reserved. Unauthorized use of this document is strictly prohibited.



This document is not intended to be used for installation purposes. We try to keep our product information up-to-date and accurate. We cannot cover all specific applications or anticipate all requirements. All specifications are subject to change without notice.



Made in the U.S. A.

For more information, contact Notifier. Phone: (203) 484-7161, FAX: (203) 484-7118.
www.notifier.com

BAT Series Batteries

Sealed Lead-Acid or Gell Cell



Power Supplies

General

BAT Series Batteries feature a new part-numbering/listing system — providing an improved method of delivery for NOTIFIER-approved sealed lead-acid batteries for all your fire alarm system needs. Multiple brands of batteries are now offered under generic part numbers, reducing backorder situations and permitting us to deliver these products in a more timely fashion. NOTIFIER has approved the multiple brands listed below as possible product shipped for a given part number. Please note that any incoming orders for “PS Series” batteries will be converted to the equivalent BAT Series part numbers.



6933cov.jpg

Features

- Provide secondary power for control panels.
- Sealed and maintenance-free.
- Overcharge protected.
- Easy handling with leakproof construction.
- Ruggedly constructed, high-impact case (ABS, polystyrene, or polypropylene, depending on models).
- Long service life.
- Compact design.

Agency Listings and Approvals

The listings and approvals below apply to BAT Series Batteries. In some cases, certain modules may not be listed by certain approval agencies, or listing may be in process. Consult factory for latest listing status.

- **UL Recognized Components:** files MH19884 (*B & B Battery*), MH20567 (*UPG, previously Jolt*), MH20845 (*Power-Sonic*).

Part Number Reference

CURRENT Part Number	BATTERY DESCRIPTION	ALTERNATES APPROVED: manufacturers and P/Ns shipped under BAT P/Ns
BAT-1250	12 V, 5 AH, sealed.	BP5-12 (B&B Battery); PS-1250 (Power-Sonic); SA1250 (Jolt) to be replaced with UB1250 (UPG).
BAT-1250	12 V, 5 AH, sealed.	BP5-12 (B&B Battery); PS-1250 (Power-Sonic); SA1250 (Jolt) to be replaced with UB1250 (UPG).
BAT-1270	12 V, 7 AH, sealed.	BP7-12 (B&B Battery); PS-1270 (Power-Sonic); SA1272 (Jolt) to be replaced with UB1270 (UPG).
BAT-12120	12 V, 12 AH, sealed.	BP12-12 (B&B Battery); PS-12120 (Power-Sonic); SA12120 (Jolt) to be replaced with UB12120 (UPG).
BAT-12180	12 V, 18 AH, sealed.	PS-12180 (Power-Sonic); SA12180 (Jolt) to be replaced with UB12180 (UPG).
BAT-12180	12 V, 18 AH, sealed.	PS-12180 (Power-Sonic); SA12180 (Jolt) to be replaced with UB12180 (UPG).
BAT-12260	12 V, 26 AH, sealed.	BP26-12 (B&B Battery); PS-12260 (Power-Sonic); SA12260 (Jolt) to be replaced with UB12260 (UPG).
BAT-12550	12 V, 55 AH, sealed.	PS-12550 (Power-Sonic); XSA12550 (Jolt) to be replaced with UB12550 (UPG).
BAT-12550	12 V, 55 AH, sealed.	PS-12550 (Power-Sonic); XSA12550 (Jolt) to be replaced with UB12550 (UPG).
BAT-121000	12 V, 100 AH, gell cell.	PS-121000 (Power-Sonic); XSA121000A (Jolt) to be replaced with UB121000 (UPG).

POWER-SONIC

Part Number Reference

1109t1.tbl

MODEL	Nominal Voltage V	Nominal Capacity @ 20 hr. rate A.H.	Discharge Current @20 hr. rate mA	DIMENSIONS									
				Width		Depth		Height		Height over terminal		Weight	
				in.	mm	in.	mm	in.	mm	in.	mm	lb.	kg.
PS-1250	12	5	250	3.54	90	2.76	70	4.02	102	4.21	107	4.1	1.9
PS-1270	12	7	325	5.94	151	2.56	65	3.7	94	3.86	98	5.7	2.6
PS-12120	12	12	600	5.94	151	3.86	98	3.7	94	3.86	98	8.8	4
PS-12180	12	18	875	7.13	181	2.99	76	6.57	167	6.57	167	12.8	5.8
PS-12250	12	25	1300	6.89	175	6.54	166	4.92	125	4.92	125	18.7	8.5
PS-12550	12	55	3000	10.25	260	6.6	168	8.2	208	9.45	240	39.7	18
PS-121000	12	100	5000	12	305	6.6	168	8.2	208	9.45	240	65.7	29.8

Characteristic Discharge Curves

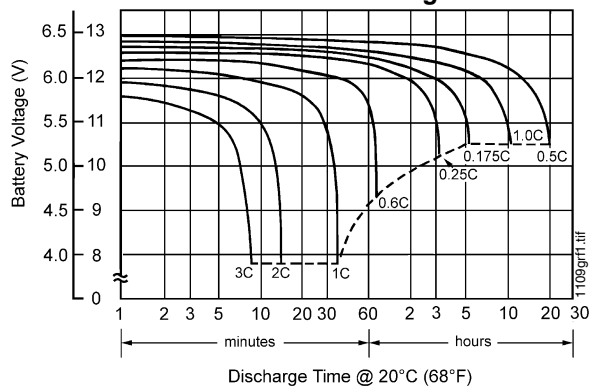

Effect of Temperature on Capacity

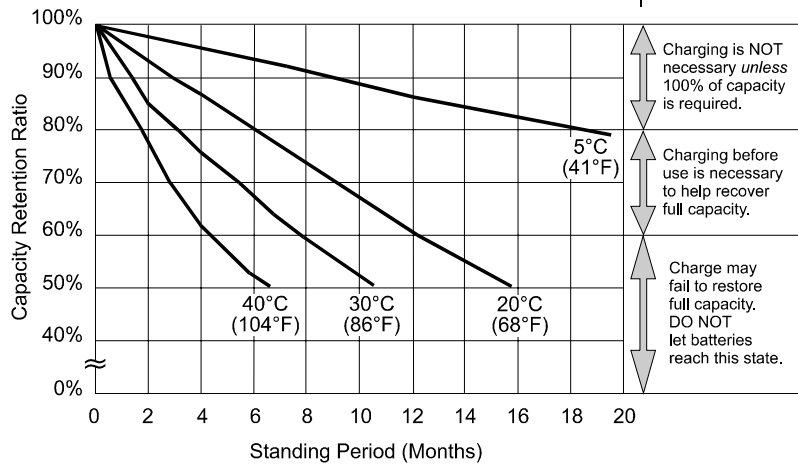
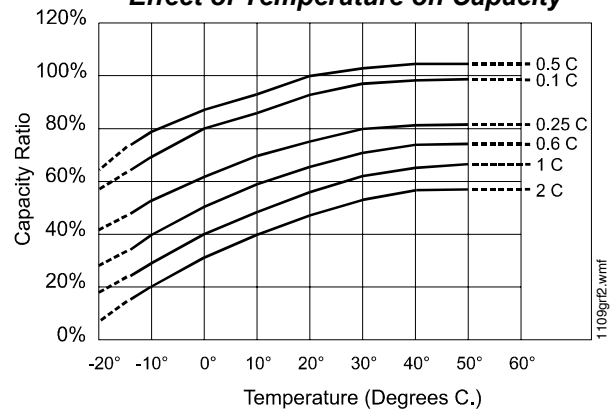

**at left:
PS-121000
Shelf-Life
and Storage**

Charging is NOT necessary unless 100% of capacity is required.
Charging before use is necessary to help recover full capacity.
Charge may fail to restore full capacity. DO NOT let batteries reach this state.

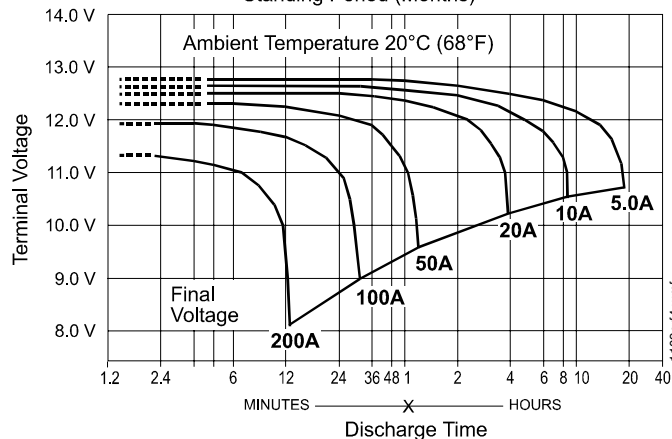

**at left:
PS-121000
Discharge
Characteristics**

NBG-12LX

Addressable Manual Pull Station



Intelligent/Addressable Devices

General

The Notifier NBG-12LX is a state-of-the-art, dual-action (i.e., requires two motions to activate the station) pull station that includes an addressable interface for any Notifier intelligent control panel except FireWarden series panels, and the NSP-25 panel. Because the NBG-12LX is addressable, the control panel can display the exact location of the activated manual station. This leads fire personnel quickly to the location of the alarm.

Features

- Maintenance personnel can open station for inspection and address setting without causing an alarm condition.
- Built-in bicolor LED, which is visible through the handle of the station, flashes in normal operation and latches steady red when in alarm.
- Handle latches in down position and the word “ACTIVATED” appears to clearly indicate the station has been operated.
- Captive screw terminals wire-ready for easy connection to SLC loop (accepts up to 12 AWG/3.25 mm² wire).
- Can be surface mounted (with SB-10 or SB-I/O) or semi-flush mounted. Semi-flush mount to a standard single-gang, double-gang, or 4" (10.16 cm) square electrical box.
- Smooth dual-action design.
- Meets ADAAG controls and operating mechanisms guidelines (Section 4.1.3[13]); meets ADA requirement for 5 lb. maximum activation force.
- Highly visible.
- Attractive shape and textured finish.
- Key reset.
- Includes Braille text on station handle.
- Optional trim ring (BG12TR).
- Meets UL 38, Standard for Manually Actuated Signaling Boxes.
- Up to 99 NBG-12LX stations per loop on CLIP protocol loops.
- Up to 159 NBG-12LX stations per loop on FlashScan® protocol loops.
- Dual-color LED blinks green to indicate normal on FlashScan® systems.

Construction

Shell, door, and handle are molded of durable polycarbonate material with a textured finish.

Specifications

- **Shipping Weight:** 9.6 oz. (272.15 g)
- **Normal operating voltage:** 24 VDC.
- **Maximum SLC loop voltage:** 28.0 VDC.
- **Maximum SLC standby current:** 375 µA.
- **Maximum SLC alarm current:** 5 mA.
- **Temperature Range:** 32°F to 120°F (0°C to 49°C)
- **Relative Humidity:** 10% to 93% (noncondensing)
- **For use indoors in a dry location**



The NBG-12LX
Addressable Manual Pull Station

Installation

The NBG-12LX will mount semi-flush into a single-gang, double-gang, or standard 4" (10.16 cm) square electrical outlet box, or will surface mount to the model SB-10 or SB-I/O surface backbox. If the NBG-12LX is being semi-flush mounted, then the optional trim ring (BG12TR) may be used. The BG12TR is usually needed for semi-flush mounting with 4" (10.16 cm) or double-gang boxes (not with single-gang boxes).

Operation

Pushing in, then pulling down on the handle causes it to latch in the down/activated position. Once latched, the word “ACTIVATED” (in bright yellow) appears at the top of the handle, while a portion of the handle protrudes from the bottom of the station. To reset the station, simply unlock the station with the key and pull the door open. This action resets the handle; closing the door automatically resets the switch.

Each manual station, on command from the control panel, sends data to the panel representing the state of the manual switch. Two rotary decimal switches allow address settings (1 – 159 on FlashScan® systems, 1 – 99 on CLIP systems).

Architectural/Engineering Specifications

Manual Fire Alarm Stations shall be non-coded, with a key-operated reset lock in order that they may be tested, and so designed that after actual Emergency Operation, they cannot be restored to normal except by use of a key. An operated station shall automatically condition itself so as to be visually detected as activated. Manual stations shall be constructed of red-colored polycarbonate material with clearly visible operating instructions provided on the cover. The word FIRE shall appear on the front of the stations in white letters, 1.00 inches (2.54 cm) or larger. Stations shall be suitable for surface mounting on matching backbox SB-10 or SB-I/O; or semi-flush mounting on a standard single-gang, double-gang, or

4" (10.16 cm) square electrical box, and shall be installed within the limits defined by the Americans with Disabilities Act (ADA) or per national/local requirements. Manual Stations shall be Underwriters Laboratories listed.

Manual stations shall connect with two wires to one of the control panel SLC loops. The manual station shall, on command from the control panel, send data to the panel representing the state of the manual switch. Manual stations shall provide address setting by use of rotary decimal switches.

The loop poll LED shall be clearly visible through the front of the station. The LED shall flash while in the normal condition, and stay steadily illuminated when in alarm.

Product Line Information

NBG-12LX: Dual-action addressable pull station. Includes key locking feature. (Listed for Canadian and non-Canadian applications.)

NBG-12LXSP: Spanish/English labelled version.

NBG-12LXP: Portuguese labelled version.

SB-10: Surface backbox; metal.

SB-I/O: Surface backbox; plastic.

BG12TR: Optional trim ring.

17021: Keys, set of two.

NY-Plate: New York City trim plate.

Agency Listings and Approvals

In some cases, certain modules or applications may not be listed by certain approval agencies, or listing may be in process. Consult factory for latest listing status.

- **UL/ULC Listed:** S692 (listed for Canadian and non-Canadian applications).
- **MEA:** 67-02-E.
- **CSFM:** 7150-0028:0199.
- **FDNY:** COA #6085 (NFS2-640), COA #6098 (NFS2-3030).
- **BSMI:** CI313066760047.
- **U.S. Coast Guard.**
- **Lloyd's Register.**
- **FM Approved.**

Patented: U.S. Patent No. D428,351; 6,380,846; 6,314,772; 6,632,108.

NOTIFIER® and FlashScan® are registered trademarks of Honeywell International Inc.

©2012 by Honeywell International Inc. All rights reserved. Unauthorized use of this document is strictly prohibited.



This document is not intended to be used for installation purposes.
We try to keep our product information up-to-date and accurate.
We cannot cover all specific applications or anticipate all requirements.
All specifications are subject to change without notice.



Made in the U.S. A.

For more information, contact Notifier. Phone: (203) 484-7161, FAX: (203) 484-7118.
www.notifier.com

NP-100(A) Series

Addressable Photoelectric Detectors for the FireWarden Series



Addressable

General

The **NP-100(A)**, **NP-100T(A)** and **NP-100R(A)** addressable, low-profile plug-in photoelectric detectors use a state-of-the-art photoelectric sensing chamber with communications to provide open area protection and are used exclusively with NOTIFIER's **FireWarden Series** (FireWarden-100-2 and FireWarden-50) and **Spartan** (NSP-25) Addressable Fire Alarm Control Panels (FACPs). The **NP-100T(A)** adds thermal sensors that will alarm at a fixed temperature of 135°F (57°C). Since these detectors are addressable, they will help emergency personnel quickly locate a fire during its early stages, potentially saving precious rescue time while also reducing property damage. Two LEDs on each sensor light to provide a local, visible sensor indication. Remote LED annunciator capability is available as an optional accessory, PN RA100Z(A). The **NP-100R(A)** is a remote test capable detector for use with DNR(A)/DNRW duct smoke detector housings.



NP-100(A) in B210LP(A) Base

B210-2851.jpg

Features

SLC loop

- Two-wire loop connection.
- Unit uses base for wiring.

Addressing

- Addressable by device.
- Rotary, decimal addressing: 01 – 99 with FireWarden-100-2 and NSP-25, and 01 – 50 with FireWarden-50.

Architecture

- Unique single-source, dual-chamber design to respond quickly and dependably to a broad range of fires.
- Sleek, low-profile design.
- Integral communications and built-in type identification.
- Built-in tamper-resistant feature.
- Removable cover and insect-resistant screen for simple field cleaning.

Operation

- Withstands air velocities up to 4,000 feet-per-minute (20 m/sec.) without triggering a false alarm.
- Factory preset at 1.5% nominal sensitivity for panel alarm threshold level.
- Visible LED “blinks” when the unit is addressed (communicating with the fire panel) and latches on in alarm.

Mechanicals

- Sealed against back pressure.
- Direct surface mounting or electrical box mounting.
- Mounts to: single-gang box, 3.5" (8.89 cm) or 4.0" (10.16 cm) octagonal box, or 4.0" (10.16 cm) square electrical box (using a plaster ring — included).

Other system features

- Fully coated circuit boards and superior RF/transient protection.
- 94-V0 plastic flammability rating.
- Low standby current.

Options

- Remote LED output connection, PN RA100Z(A).

Applications

Use photoelectric detectors in life-safety applications to provide a broad range of fire-sensing capability, especially where smoldering fires are anticipated. Ionization detectors are often better than photoelectric detectors at sensing fast, flaming fires.

Construction

These detectors are constructed of off-white fire resistant plastic. NP-100(A) series plug-in, low-profile smoke detectors are designed to commercial standards and offer an attractive appearance.

Installation

NP-100(A) series plug-in detectors use a detachable mounting base to simplify installation, service and maintenance.

Mount base (all base types) on an electrical backbox which is at least 1.5" (3.81 cm) deep. For a chart of compatible junction boxes, see *DN-60054*.

NOTE: Because of the inherent supervision provided by the SLC loop, end-of-line resistors are not required. Wiring “T-taps” or branches are permitted for Style 4 (Class B) wiring. NP-100R(A) mounts in a DNR(A)/DNRW duct detector housing.

Operation

Each NP-100(A) series detector uses one of 99 possible addresses on the FireWarden-100-2 and NSP-25, or one of 50 possible addresses on the FireWarden-50 Signaling Line Circuit (SLC). It responds to regular polls from the system and reports its type and status.

The addressable photoelectric sensor in the NP-100(A) series has a unique unipolar chamber that responds quickly and uniformly to a broad range of smoke conditions. It can withstand wind gusts up to 4,000 feet-per-minute (20 m/sec.) without sending an alarm level signal. Because of its unipolar chamber, the NP-100(A) series is approximately two times more responsive than most photoelectric sensors. This makes it a more stable detector.

Detector Sensitivity Test

Each detector can have its sensitivity tested (required per NFPA 72, Chapter 14 on *Inspection, Testing and Maintenance*) when installed/connected to a FireWarden-100-2 or FireWarden-50 addressable fire alarm control panel. The results of the sensitivity test can be printed off the FireWarden-100-2 or FireWarden-50 for record keeping.

Specification

Voltage range: 15 – 32 VDC (peak).

Standby current: 300 μ A @ 24 VDC.

LED current: 6.5 mA @ 24 VDC (latched "ON").

Air velocity: 4,000 ft./min. (20 m/sec.) maximum.

Size: 2.1" (5.33 cm) high; base determines diameter.

- **B210LP(A):** 6.1" (15.5 cm) diameter.
- **B501(A):** 4.1" (10.4 cm) diameter.
- **B200SR(A):** 6.875" (17.46 cm) diameter.
- **B224RB(A):** 6.2" (15.748 cm) diameter.

Weight: 3.6 oz. (102 g).

Operating temperature range: for **NP-100(A):** 0°C to 49°C (32°F to 120°F); for **NP-100T(A):** 0°C to 38°C (32°F to 100°F). **NP-100R(A):** installed in a DNR(A)/DNRW -20°C to 70°C (-4°F to 158°F).

Temperature: 0°C – 49°C (32°F – 120°F).

Relative humidity: 10% – 93%, non-condensing.

Listings

Listings and approvals below apply to the NP-100(A), NP-100T(A), and NP-100R(A) detectors. In some cases, certain modules may not be listed by certain approval agencies, or listing may be in process. Consult factory for latest listing status.

- **UL Listed:** S1115.
- **ULC Listed:** S911.
- **CSFM:** 7272-0028:0231.
- **MEA:** 243-02-E Vol. 2.
- **Maryland State Fire Marshal:** permit 2173.
- **FM approved.**

Product Line Information

NOTE: "A" suffix indicates ULC Listed model.

NP-100: Addressable photoelectric detector; B210LP base included.

NP-100A: Same as NP-100 with ULC Listing; B210LPA base included.

NP-100T: Same as NP-100 but with **thermal** element; B210LP base included.

NP-100TA: Same as NP-100T with ULC Listing; B210LPA base included.

NP-100R: Remote test capable addressable photoelectric detector for use with a DNRA/DNRW duct detector housing; B210LP base included.

NP-100RA: Same as NP-100R with ULC Listing for use with a DNRA duct detector housing; B210LPA base included.

INTELLIGENT BASES

NOTE: "A" suffix indicates ULC Listed model.

NOTE: For details about intelligent bases and their mounting, see DN-60054.

B210LP(A): Plug-in detector base (included); standard U.S. flanged low-profile mounting base.

B210LPBP: Bulk pack of B210LP; package contains 10.

B501(A): Standard European flangeless mounting base.

B501BP: Bulk pack of B501; package contains 10.

B200SR(A): Intelligent sounder base capable of producing sound output with ANSI Temporal 3 or continuous tone. Replaces B501BH series bases in retrofit applications.

B224RB(A): Plug-in System Sensor **relay** base. Screw terminals: up to 14 AWG (2.0 mm²). Relay type: Form-C. Rating: 2.0 A @ 30 VDC resistive; 0.3 A @ 110 VDC inductive; 1.0 A @ 30 VDC inductive.

B224BI(A): Plug-in System Sensor **isolator** detector base. Maximum 25 devices between isolator bases (see DN-6994).

ACCESSORIES

F110: Retrofit flange to convert B210LP(A) to match the B710LP(A) profile, or to convert older high-profile bases to low-profile.

F110BP: Bulk pack of F110; package contains 15.

F210: Replacement flange for B210LP(A) base.

RA100Z(A): Remote LED annunciator. 3 – 32 VDC. Mounts to a U.S. single-gang electrical box. For use with B501(A) and B210LP(A) bases only.

SMB600: Surface mounting kit

M02-04-00: Test magnet.

M02-09-00: Test magnet with telescoping handle.

XR2B: Detector removal tool. Allows installation and/or removal of detector heads from bases in high ceiling applications.

XP-4: Extension pole for XR2B. Comes in three 5-foot (1.524 m) sections.

T55-127-010: Detector removal tool without pole.

BCK-200B: Black detector covers for use with NP-100(A) only; box of 10.

WCK-200B: White detector covers for use with NP-100(A) only; box of 10.

NOTIFIER® and FireWarden® are registered trademarks of Honeywell International Inc.
©2011. All rights reserved. Unauthorized use of this document is strictly prohibited.



This document is not intended to be used for installation purposes.
We try to keep our product information up-to-date and accurate.
We cannot cover all specific applications or anticipate all requirements.
All specifications are subject to change without notice.



Made in the U.S. A.

For more information, contact Notifier. Phone: (203) 484-7161, FAX: (203) 484-7118.
www.notifier.com

NH-100(A) Series

Intelligent Addressable Thermal Detectors for FireWarden Series



Addressable

General

The **NOTIFIER NH-100(A) Series** thermal detectors are addressable sensors that use a state-of-the-art thermistor sensing circuit for fast response. These sensors provide open-area protection and are intended for use with **FireWarden Series** (FireWarden-100-2 and FireWarden-50) and **Spartan Series** (NSP-25) addressable Fire Alarm Control Panels (FACPs).

The **NH-100(A)** and **NH-100R(A)** sensors provide fixed temperature alarm detection at 135°F (57°C). The **NH-100R(A)** sensor also responds to rate-of-rise conditions of greater than 15°F (8.3°C) per minute. The **NH-100H(A)** is a fixed high-temperature detector that activates at 190°F (88°C). These thermal detectors provide addressable property protection in a variety of applications.

Two LEDs on each sensor light to provide a local, visible sensor indication. Remote LED annunciator capability is available using an optional accessory, the RA100Z.

Features

SLC loop:

- Two-wire SLC loop connection.
- Unit uses base for wiring.

Addressing:

- Addressable by device.
- Rotary, decimal addressing: 01 – 99 with FireWarden-100-2, NSP-25, 01 – 50 with FireWarden-50.

Architecture:

- Sleek, low-profile, stylish design.
- State-of-the-art thermistor technology for fast response.
- Integral communications and built-in device-type identification.
- Built-in tamper resistant feature.
- Built-in functional test switch activated by external magnet.

Operation:

- Factory preset at 135°F (57°C) for the NH-100(A) and NH-100R(A); 190°F (88°C) for the NH-100H(A).
- Rate-of-rise triggers at 15°F (8.3°C) per minute for the NH-100R(A).
- 360°-field viewing angle of the visual alarm indicators (two bicolor LEDs). LEDs blink red in Normal condition and turn on steady red in Alarm.
- Visible LEDs “blink” every time the unit is addressed.

Mechanicals:

- Sealed against back pressure.
- SEMS screws for wiring of the separate base.
- Designed for direct-surface or electrical-box mounting.
- Plugs into separate base for ease of installation and maintenance.
- Separate base allows interchange of photoelectric, ionization and thermal sensors.

Other system features:

- Remote test feature from the panel.
- Walk test with address display.



NH-100(A) in B210LP(A) Base

B210-2251.jpg

- Low standby current.
- 94-5V plastic flammability rating.

Options:

- Remote LED output connection to optional RA100Z remote LED annunciator.
- Flanged surface mounting kit.

Installation

NH-100(A) Series plug-in intelligent thermal detectors use a detachable base to simplify installation, service and maintenance. Installation instructions are shipped with each detector.

Mount base (all base types) on an electrical backbox which is at least 1.5" (3.81 cm) deep. For a chart of compatible junction boxes, see *DN-60054*.

NOTE: Because of the inherent supervision provided by the SLC loop, end-of-line resistors are not required. Wiring “T-taps” or branches are permitted for Style 4 (Class “B”) wiring only.

Applications

Use thermal detectors for protection of property.

Construction

These detectors are constructed of off-white fire-resistant plastic. The NH-100(A) Series plug-in intelligent thermal detectors are designed to commercial standards and offer an attractive appearance.

Operation

Each NH-100(A) Series detector uses one of 99 (FireWarden-100-2, NSP-25) or 50 (FireWarden-50) possible addresses on a control panel SLC loop. It responds to regular polls from the control panel and reports its type and the status. If it receives a test command from the panel (or a local magnet test), it stimulates its electronics and reports an alarm. It blinks its LEDs when polled and turns the LEDs on when commanded by the panel. The NH-100(A) Series offers features and performance that represent the latest in thermal detector technology.

Specifications

Size: 2.1" (5.3 cm) high; base determines diameter.

- **B210LP(A):** 6.1" (15.5 cm) diameter.
- **B501(A):** 4.1" (10.4 cm) diameter.
- **B200SR(A):** 6.875" (17.46 cm) diameter.
- **B224RB(A):** 6.2" (15.748 cm) diameter.

Shipping weight: 4.8 oz. (137 g).

Installation temperature:

- NH-100(A), NH-100R(A): –4°F to 100°F (–20°C to 38°C).
- NH-100H(A): –4°F to 150°F (–20°C to 66°C).

Humidity range: 10% to 93% relative humidity (noncondensing).

Voltage range: 15 to 32 VDC peak.

Standby current: 300 µA @ 24 VDC (one communication every five seconds with LED blink enabled).

LED current: 6.5 mA @ 24 VDC.

Mounting: B210LP(A) flanged base, included. See "Product Line Information: Intelligent Bases" if using a different base.

Fixed-temperature setpoint: 135°F (57°C) for the NH-100 and NH-100R(A)(A); 190°F (88°C) for the NH-100H(A).

Rate-of-rise detection: responds to greater than 15°F (8.3°C) per minute.

Listings and Approvals

Listings and approvals below apply to the NH-100(A) Series detectors. In some cases, certain modules may not be listed by certain approval agencies, or listing may be in process. Consult factory for latest listing status.

- **UL Listed:** S747.
- **ULC Listed:** S747.
- **CSFM:** 7270-0028:0234.
- **MEA:** 387-02-E Vol. II.
- **FM approved.**

Product Line Information

NOTE: "A" suffix indicates ULC Listed model.

NH-100: Intelligent thermal sensor; 135° F (57° C); B210LP base included.

NH-100A: Same as NH-100 but with ULC Listing; B210LPA base included.

NH-100R: Same as NH-100 with *rate-of-rise* feature; B210LP base included.

NH-100RA: Same as NH-100R but with ULC Listing; B210LPA base included.

NH-100H: Intelligent fixed high-temperature thermal detector; 190° F (88° C); B210LP base included.

NH-100HA: Same as NH-100H but with ULC Listing; B210LPA base included.

INTELLIGENT BASES

NOTE: "A" suffix indicates ULC Listed model.

NOTE: For details about intelligent bases and their mounting, see DN-60054.

B210LP(A): Plug-in detector base (included); standard U.S. flanged low-profile mounting base.

B210LPBP: Bulk pack of B210LP; package contains 10.

B501(A): Standard European flangeless mounting base.

B501BP: Bulk pack of B501; package contains 10.

B200SR(A): Intelligent sounder base capable of producing sound output with ANSI Temporal 3 or continuous tone. Replaces B501BH series bases in retrofit applications.

B224RB(A): Plug-in System Sensor **relay** base. Screw terminals: up to 14 AWG (2.0 mm²). Relay type: Form-C. Rating: 2.0 A @ 30 VDC resistive; 0.3 A @ 110 VDC inductive; 1.0 A @ 30 VDC inductive.

B224BI(A): Plug-in System Sensor **isolator** detector base. Maximum 25 devices between isolator bases (*see DN-6994*).

ACCESSORIES

F110: Retrofit flange to convert B210LP(A) to match the B710LP(A) profile, or to convert older high-profile bases to low-profile.

F110BP: Bulk pack of F110; package contains 15.

F210: Replacement flange for B210LP(A) base.

RA100Z(A): Remote LED annunciator. 3 – 32 VDC. Mounts to a U.S. single-gang electrical box. For use with B501(A) and B210LP(A) bases only.

SMB600: Surface mounting kit

M02-04-00: Test magnet.

M02-09-00: Test magnet with telescoping handle.

XR2B: Detector removal tool. Allows installation and/or removal of detector heads from bases in high ceiling applications.

XP-4: Extension pole for XR2B. Comes in three 5-foot (1.524 m) sections.

T55-127-010: Detector removal tool without pole.

NOTIFIER® and FireWarden® are registered trademarks of Honeywell International Inc.

©2013. All rights reserved. Unauthorized use of this document is strictly prohibited.



This document is not intended to be used for installation purposes.
We try to keep our product information up-to-date and accurate.
We cannot cover all specific applications or anticipate all requirements.
All specifications are subject to change without notice.



For more information, contact Notifier. Phone: (203) 484-7161, FAX: (203) 484-7118.
www.notifier.com

Monitor Modules

NMM-100(A), NMM-100P(A), NZM-100(A), and NDM-100(A) for FireWarden Series Panels



Intelligent Addressable Devices

General

Four different monitor modules are available for Notifier's FireWarden Series intelligent control panels for a variety of applications. Monitor modules supervise a circuit of dry-contact input devices, such as conventional heat detectors and pull stations, or monitor and power a circuit of two-wire smoke detectors (NZM-100(A)).

NMM-100(A) is a standard-sized module (typically mounts to a 4" [10.16 cm] square box) that supervises either a Style D (Class A) or Style B (Class B) circuit of dry-contact input devices.

NMM-100P(A) is a miniature monitor module a mere 1.3" (3.302 cm) H x 2.75" (6.985 cm) W x 0.5" (1.270 cm) D that supervises a Style B (Class B) circuit of dry-contact input devices. Its compact design allows the NMM-100P(A) to be mounted in a single-gang box behind the device it monitors.

NZM-100(A) is a standard-sized module that monitors and supervises compatible two-wire, 24 volt, smoke detectors on a Style D (Class A) or Style B (Class B) circuit.

NDM-100(A) is a standard-sized dual monitor module that monitors and supervises two independent two-wire Style B (Class B) dry-contact initiating device circuits (IDCs) at two separate, consecutive addresses in intelligent, two-wire systems.

NMM-100(A) Monitor Module

- Built-in type identification automatically identifies this device as a monitor module to the control panel.
- Powered directly by two-wire SLC loop. No additional power required.
- High noise (EMF/RFI) immunity.
- SEMS screws with clamping plates for ease of wiring.
- Direct Decade entry of address: 01 – 99 on FireWarden-100-2, 01 – 50 on FireWarden-50.
- LED flashes during normal operation and latches on steady to indicate alarm.

The NMM-100(A) Monitor Module is intended for use in intelligent, two-wire systems, where the individual address of each module is selected using the built-in rotary switches. It provides either a two-wire or four-wire fault-tolerant Initiating Device Circuit (IDC) for normally-open-contact fire alarm and supervisory devices. The module has a panel-controlled LED indicator.

NMM-100(A) APPLICATIONS

Use to monitor a zone of four-wire smoke detectors, manual fire alarm pull stations, waterflow devices, or other normally-open dry-contact alarm activation devices. May also be used to monitor normally-open supervisory devices with special supervisory indication at the control panel. Monitored circuit may be wired as an NFPA Style B (Class B) or Style D (Class A) Initiating Device Circuit. A 47K ohm End-of-Line Resistor (provided) terminates the Style B circuit. No resistor is required for supervision of the Style D circuit.



NMM-100(A) (Type H)

NMM-100(A) OPERATION

Each NMM-100(A) uses one of the available module addresses on an SLC loop. It responds to regular polls from the control panel and reports its type and the status (open/normal/short) of its Initiating Device Circuit (IDC). A flashing LED indicates that the module is in communication with the control panel. The LED latches steady on alarm (subject to current limitations on the loop).

NMM-100(A) SPECIFICATIONS

Nominal operating voltage: 15 to 32 VDC.

Maximum current draw: 5.0 mA (LED on).

Average operating current: 350 μ A (LED flashing), 1 communication every 5 seconds, 47k EOL.

Maximum IDC wiring resistance: 40 ohms.

EOL resistance: 47K ohms.

Temperature range: 32°F to 120°F (0°C to 49°C).

Humidity range: 10% to 93% noncondensing.

Dimensions: 4.5" (11.43 cm) high x 4" (10.16 cm) wide x 1.25" (3.175 cm) deep. Mounts to a 4" (10.16 cm) square x 2.125" (5.398 cm) deep box.

NMM-100P(A) Mini Monitor Module

- Built-in type identification automatically identifies this device as a monitor module to the panel.
- Powered directly by two-wire SLC loop. No additional power required.
- High noise (EMF/RFI) immunity.
- Tinned, stripped leads for ease of wiring.
- Direct Decade entry of address: 01 – 99 on FireWarden-100-2, 01 – 50 on FireWarden-50.

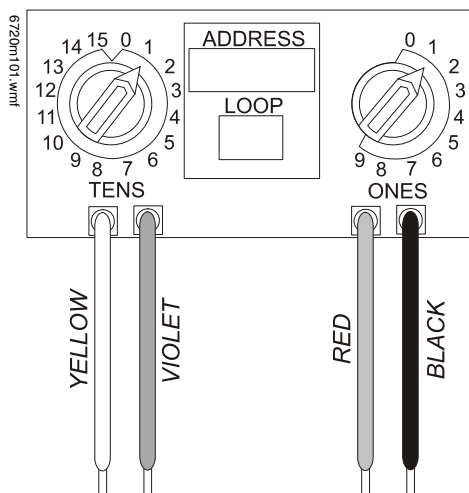

The NMM-100P(A) Mini Monitor Module can be installed in a single-gang junction directly behind the monitored unit. Its small size and light weight allow it to be installed without rigid mounting. The NMM-100P(A) is intended for use in intelligent, two-wire systems where the individual address of each module is selected using rotary switches. It provides a two-wire initiating device circuit for normally-open-contact fire alarm and security devices. NMM-100P(A)

NMM-100P(A) APPLICATIONS

Use to monitor a single device or a zone of four-wire smoke detectors, manual fire alarm pull stations, waterflow devices, or other normally-open dry-contact devices. May also be used to monitor normally-open supervisory devices with special supervisory indication at the control panel. Monitored circuit/device is wired as an NFPA Style B (Class B) Initiating Device Circuit. A 47K ohm End-of-Line Resistor (provided) terminates the circuit.

NMM-100P(A) OPERATION

Each NMM-100P(A) uses one of the available module addresses on an SLC loop. It responds to regular polls from the control panel and reports its type and the status (open/normal/short) of its Initiating Device Circuit (IDC).

NMM-100P(A) SPECIFICATIONS

Nominal operating voltage: 15 to 32 VDC.

Average operating current: 350 μ A, 1 communication every 5 seconds, 47k EOL; 600 μ A Max. (Communicating, IDC Shorted).

Maximum IDC wiring resistance: 40 ohms.

Maximum IDC Voltage: 11 Volts.

Maximum IDC Current: 400 μ A.

EOL resistance: 47K ohms.

Temperature range: 32°F to 120°F (0°C to 49°C).

Humidity range: 10% to 93% noncondensing.

Dimensions: 1.3" (3.302 cm) high x 2.75" (6.985 cm) wide x 0.65" (1.651 cm) deep.

Wire length: 6" (15.24 cm) minimum.

NZM-100(A) Interface Module

- Supports compatible two-wire smoke detectors.
- Supervises IDC wiring and connection of external power source.
- High noise (EMF/RFI) immunity.
- SEMS screws with clamping plates for ease of wiring.
- Direct Decade entry of address: 01 – 99 on FireWarden-100-2, 01 – 50 on FireWarden-50.
- LED flashes during normal operation.
- LED latches steady to indicate alarm on command from control panel.

The NZM-100(A) Interface Module is intended for use in intelligent, addressable systems, where the individual address of each module is selected using built-in rotary switches. This module allows intelligent panels to interface and monitor two-wire conventional smoke detectors. It transmits the status (normal, open, or alarm) of one full zone of conventional detectors back to the control panel. All two-wire detectors being monitored must be UL compatible with the module.

NZM-100(A) APPLICATIONS

Use the NZM-100(A) to monitor a zone of two-wire smoke detectors. The monitored circuit may be wired as an NFPA Style B (Class B) or Style D (Class A) Initiating Device Circuit. A 3.9 K ohm End-of-Line Resistor (provided) terminates the end of the Style B or D (class B or A) circuit (maximum IDC loop resistance is 25 ohms). Install ELR across terminals 8 and 9 for Style D application.

NZM-100(A) OPERATION

Each NZM-100(A) uses one of the available module addresses on an SLC loop. It responds to regular polls from the control panel and reports its type and the status (open/normal/short) of its Initiating Device Circuit (IDC). A flashing LED indicates that the module is in communication with the control panel. The LED latches steady on alarm (subject to current limitations on the loop).

NZM-100(A) SPECIFICATIONS

Nominal operating voltage: 15 to 32 VDC.

Maximum current draw: 5.1 mA (LED on).

Maximum IDC wiring resistance: 25 ohms.

Average operating current: 300 μ A, 1 communication and 1 LED flash every 5 seconds, 3.9k eol.

EOL resistance: 3.9K ohms.

External supply voltage (between Terminals T3 and T4): DC voltage: 24 volts power limited. Ripple voltage: 0.1 Vrms maximum. Current: 90 mA per module maximum.

Temperature range: 32°F to 120°F (0°C to 49°C).

Humidity range: 10% to 93% noncondensing.

Dimensions: 4.5" (11.43 cm) high x 4" (10.16 cm) wide x 1.25" (3.175 cm) deep. Mounts to a 4" (10.16 cm) square x 2.125" (5.398 cm) deep box.

NDM-100(A) Dual Monitor Module

The NDM-100(A) Dual Monitor Module is intended for use in intelligent, two-wire systems. It provides two independent two-wire initiating device circuits (IDCs) at two separate, consecutive addresses. It is capable of monitoring normally open contact fire alarm and supervisory devices. The module has a single panel-controlled LED.

NOTE: The NDM-100(A) provides two Style B (Class B) IDC circuits ONLY. Style D (Class A) IDC circuits are NOT supported in any application.

NDM-100(A) SPECIFICATIONS

Normal operating voltage range: 15 to 32 VDC.

Maximum current draw: 6.4 mA (LED on).

Average operating current: 750 μ A (LED flashing).

Maximum IDC wiring resistance: 1,500 ohms.

Maximum IDC Voltage: 11 Volts.

Maximum IDC Current: 240 μ A

EOL resistance: 47K ohms.

Maximum SLC Wiring resistance: 40 Ohms.

Temperature range: 32° to 120°F (0° to 49°C).

Humidity range: 10% to 93% (non-condensing).

Dimensions: 4.5" (11.43 cm) high x 4" (10.16 cm) wide x 2.125" (5.398 cm) deep.

NDM-100(A) AUTOMATIC ADDRESSING

The NDM-100(A) automatically assigns itself to two addressable points, starting with the original address. For example, if the NDM-100(A) is set to address "26", then it will automatically assign itself to addresses "26" and "27".

NOTE: "Ones" addresses on the NDM-100(A) are 0, 2, 4, 6, or 8 only. Terminals 6 and 7 use the first address, and terminals 8 and 9 use the second address.



CAUTION:

Avoid duplicating addresses on the system.

Installation

NMM-100(A), NZM-100(A), and NDM-100(A) modules mount directly to a standard 4" (10.16 cm) square, 2.125" (5.398 cm) deep, electrical box. They may also be mounted to the SMB500 surface-mount box. Mounting hardware and installation instructions are provided with each module. All wiring must conform to applicable local codes, ordinances, and regulations. These modules are intended for power-limited wiring only.

The NMM-100P(A) module is intended to be wired and mounted without rigid connections inside a standard electrical box. All wiring must conform to applicable local codes, ordinances, and regulations.

Agency Listings and Approvals

In some cases, certain modules may not be listed by certain approval agencies, or listing may be in process. Consult factory for latest listing status.

- **UL:** S635
- **ULC:** S635
- **FM Approved**
- **CSFM:** 7300-0028:0230 (NMM-100, NMM-100P, NZM-100); 7300-0028:0237 (NDM-100)

- **MEA:** 72-01-E Vol. 2 (NMM-100, NMM-100P, NZM-100); 227-03-E Vol. 3 (NDM-100)

Product Line Information

NOTE: "A" suffix indicates ULC-listed model.

NMM-100(A): Monitor module.

NMM-100P(A): Monitor module, miniature.

NZM-100(A): Monitor module, two-wire detectors.

NDM-100(A): Monitor module, dual, two independent Class B circuits.

SMB500: Optional surface-mount backbox.

NOTE: See installation instructions and refer to the SLC Wiring Manual, PN 52304.

Notifier® and FireWarden® are registered trademarks and FireWatch™ is a trademark of Honeywell International Inc.
©2010 by Honeywell International Inc. All rights reserved. Unauthorized use of this document is strictly prohibited.



This document is not intended to be used for installation purposes.
We try to keep our product information up-to-date and accurate.
We cannot cover all specific applications or anticipate all requirements.
All specifications are subject to change without notice.



Made in the U.S. A.

For more information, contact Notifier. Phone: (203) 484-7161, FAX: (203) 484-7118.
www.notifier.com

NC-100R(A)

Relay Module for FireWarden Series Panels

Addressable

General

The **NC-100R(A)** Addressable Relay Module provides NOTIFIER's **FireWarden Series** intelligent control panels with two isolated sets of Form-C dry-contact outputs for activating a variety of auxiliary devices, such as fans, dampers, door holders, control equipment, etc. Addressability allows the dry contact to be activated, either manually or through panel programming, on a select basis.

Features

- Built-in type identification automatically identifies these devices to the control panel.
- Internal circuitry and relay powered directly by two-wire SLC loop.
- Integral LED "blinks" green each time a communication is received from the control panel and turns on in steady when activated.
- High noise immunity (EMF/RFI).
- Wide viewing angle of LED.
- SEMS screws with clamping plates for wiring ease.
- Direct Decade entry of address: 01 – 99 with the FireWarden-100-2(C) and 01 – 50 with the FireWarden-50(C).

Applications

The NC-100R(A) may be programmed to operate dry contacts for door holders, Air Handling Unit shutdown, etc., and to reset four-wire smoke detector power.

Construction

- The face plate is made of off-white heat-resistant plastic.
- Controls include two rotary switches for direct-dial entry of address setting.
- The NC-100R(A) provides two Form-C dry contacts that switch together.

Operation

Each NC-100R(A) uses one of the addresses on a SLC loop. It responds to regular polls from the control panel and reports its type and status. The LED blinks with each poll received. On command, it activates its internal relay.

Rotary switches set a unique address for each module. The address may be set before or after mounting. The built-in TYPE CODE (not settable) will identify the module to the control panel.

NC-100R(A)

60379cov.jpg

Specifications

Normal operating voltage: 15 to 32 VDC.

Maximum SLC current draw: 6.5 mA (LED).

Average operating current: 230 μ A direct poll (CLIP mode), 255 μ A group poll with LED flashing.

EOL resistance: not used.

Temperature range: 32°F to 120°F (0°C to 49°C).

Humidity range: 10% to 93% non-condensing.

Dimensions: 4.5" (11.43 cm) high x 4" (10.16 cm) wide x 1.25" (3.175 cm) deep. Mounts to a 4" (10.16 cm) square x 2.125" (5.398 mm) deep box.

Relay Contact Ratings

Load Description	Application	Maximum Voltage	Current Rating
Resistive	Non-Coded	30 VDC	3.0 A
Resistive	Coded	30 VDC	2.0 A
Resistive	Non-Coded	110 VDC	0.9 A
Resistive	Non-Coded	125 VAC	0.9 A
Inductive (L/R=5ms)	Coded	30 VDC	0.5 A
Inductive (L/R=2ms)	Coded	30 VDC	1.0 A
Inductive (PF=0.35)	Non-Coded	125 VAC	0.5 A

Agency Listings and Approvals

In some cases, certain modules may not be listed by certain approval agencies, or listing may be in process. Consult factory for latest listing status.

- **UL/ULC Listed:** S635.
- **CSFM approved:** file 7300-0028:230.
- **FM approved.**
- **MEA approved:** file 72-01-E, Vol. 2.

Product Line Information

NC-100R: Intelligent addressable relay module.

NC-100RA: Intelligent addressable relay module, ULC listed model.

SMB500: Optional surface-mount backbox.

NOTE: For installation instructions, see document 156-2593-001 and refer to the SLC Wiring Manual, document 52304.

NOTIFIER® is a registered trademark of Honeywell International Inc.
©2010 by Honeywell International Inc. All rights reserved. Unauthorized use of this document is strictly prohibited.



This document is not intended to be used for installation purposes.
We try to keep our product information up-to-date and accurate.
We cannot cover all specific applications or anticipate all requirements.
All specifications are subject to change without notice.



Made in the U.S. A.

For more information, contact Notifier. Phone: (203) 484-7161, FAX: (203) 484-7118.
www.notifier.com

CO1224T/CO1224A

Conventional Carbon Monoxide Detector



Conventional Initiating Devices

General

Carbon monoxide (CO) is an odorless, colorless, tasteless and highly toxic gas that is produced when fuels, such as wood, gasoline, charcoal and oil, are burned with insufficient air. The majority of residential and commercial fatalities caused from these fuels come from heating systems, power tools and charcoal grills.

If carbon monoxide is detected, the **CO1224T/CO1224A** will alert by sounding and flashing a temp-4 signal alarm. Protection is guaranteed 24/7 by a central station if connected to a panel with a digital alarm communicator.

The CO1224T/CO1224A is specifically designed for system operation. This means the detector is fully listed to UL Standard 2075, offering a code required trouble relay, which sends a sensor failure or end-of-life signal to the control panel and the central station, as well as SEMS-type terminal Phillips-head screws, which provide a quicker and more positive wiring connection and code required wiring supervision. Also, the offers low current draw, allowing more detectors to be connected to the panel without having to purchase a more expensive panel or an extra power supply.

Add addressability to the by supervising the circuit with a compatible monitor module such as the FMM-101(A).

Special to the CO1224T is RealTest™ technology that allows testing of its internal CO detector with a carbon monoxide gas agent. There are few steps: Hold the test button for two seconds, and after the green LED begins to flash about once per second, spray a small amount of CO into the detector. The detector will alarm to indicate presence of gas.

NOTE: RealTest™ is only available on the UL-listed CO1224T. Refer to the installation documents for details and cautions.

Features

- In the CO1224T, RealTest™ technology allows installer to test detector with CO gas.
- Full compliance with UL 2075.
- A code required trouble relay.
- Wiring supervision with SEMS terminals.
- A six-year end-of-life timer.
- 12/24 VDC.
- A current draw of 20mA in standby and 40mA in alarm.
- Versatile mounting for wall and ceiling.
- Electrochemical sensing technology.

Specifications

ARCHITECTS'/ENGINEERS' SPECIFICATIONS

Carbon monoxide detector shall be a System Sensor model number , listed to UL 2075 for Gas and Vapor Detectors and Sensors. The detector shall be equipped with a sounder and a trouble relay. The detector's base shall be able to mount to a single-gang electrical box or direct (surface) mount to the wall or ceiling. Wiring connections shall be made by means of SEMS screws. The detector shall provide dual color LED indication, which blinks to indicate normal standby, alarm, or end-of-life. When the sensor supervision is in a trouble condition, the detector shall send a trouble signal to the panel. When the



detector gives a trouble or end-of-life signal, the detector shall be replaced.

ELECTRICAL SPECIFICATIONS

Operating Voltage: 12/24 VDC

Audible Signal: 85 dB in alarm

Standby Current: 20 mA

Alarm Current: 40 mA (75 mA test)

Alarm Contact Ratings: 0.5 A @ 30 VDC

Trouble Contact Ratings: 0.5 A @ 30 VDC

PHYSICAL SPECIFICATIONS

Size: 5.1"L x 3.3"W x 1.3"H

Approximate Weight: 7 oz

Operating Temperature Range: 0°C to 40°C (32°F to 104°F)

Operating Humidity Range: 22% to 90% RH

Input Terminals: 14 to 22 AWG

Mounting: Single-gang backbox; surface mount to wall or ceiling.

Operation Modes

Operation Mode	Green LED	Red LED	Sounder
Normal (Standby)	Blink 1 per minute	–	–
Alarm	–	Blink in Temporal 4 pattern	Sound in Temporal 4 pattern
RealTest™ (CO1224T only)	Blink 1 per second	–	–

Hush Feature: Pushing the Test/Hush button will silence the sounder for 5 minutes (except in RealTest mode).

Trouble Feature: When the detector is in a trouble condition, it will send a trouble signal to the panel via the trouble contact.

End-of-Life Timer: After the sensor inside the detector has reached the end of its useful life, a trouble signal will be sent to the panel. This will indicate that it is time to replace the detector. An electrochemical carbon monoxide detector life span is approximately six years, and the detector must be replaced by the date marked on the inside of the product.

MONITOR MODULE APPLICATIONS

When used in conjunction with the CO1224T or CO1224A, the monitor module should be programmed as a supervisory device type and is not suitable for evacuation purposes. Wire the module as an NFPA Style B (Class B) Initiating Device Circuit and terminate the with a 47K ohm End-of-line resistor (provided).

Listings and Approvals

The listings and approvals below apply to the CO1224T and CO1224A. In some cases, certain modules may not be listed by certain approval agencies, or listing may be in process. Consult factory for latest listing status.

- **UL Listed:** E307195 (CO1224T)
- **ULC Listed:** E304075 (CO1224A)

Product Line Information

CO1224T: 12/24 volt, 4-wire system-monitored carbon monoxide detector with RealTest™ Technology. Replaces CO1224.

CO1224A: 12/24 volt, 4-wire system-monitored carbon monoxide detector, ULC-listed for use in Canadian applications.

CO-PLATE: CO detector replacement plate, package of 5. Covers previously installed round detectors' footprints for a clean, low-profile finish.

Notifier® is a registered trademark and RealTest™ is a trademark of Honeywell International Inc.
©2010 by Honeywell International Inc. All rights reserved. Unauthorized use of this document is strictly prohibited.



This document is not intended to be used for installation purposes.
We try to keep our product information up-to-date and accurate.
We cannot cover all specific applications or anticipate all requirements.
All specifications are subject to change without notice.



Made in the U.S. A.

For more information, contact Notifier. Phone: (203) 484-7161, FAX: (203) 484-7118.
www.notifier.com

SpectrAlert® Advance

Selectable Output Notification Appliances



Audio/Visual Devices

General

System Sensor® SpectrAlert® Advance selectable-output horns, strobes and horn/strobes are rich with features guaranteed to cut installation times and maximize profits. The SpectrAlert Advance series of notification appliances is designed to simplify your installations, with features such as: plug-in designs, instant feedback messages to ensure correct installation of individual devices, and eleven field-selectable candela settings for wall and ceiling strobes and horn/strobes.

More specifically, when installing Advance products, first attach a universal mounting plate to a four-inch square, four-inch octagon, or double-gang junction box. The two-wire mounting plate attaches to a single-gang junction box.

Then, connect the notification appliance circuit wiring to the SEMS terminals on the mounting plate.

Finally, attach the horn, strobe, or horn/strobe to the mounting plate by inserting the product's tabs in the mounting plate's grooves. The device will rotate into position, locking the product's pins into the mounting plate's terminals. The device will temporarily hold in place with a catch until it is secured with a captured mounting screw.

SpectrAlert Advance products allow you to choose:

- 12 or 24 volts.
- 15, 15/75, 30, 75, 95, 110, 115, 135, 150, 177, or 185 candela by way of a rear-mounted slide switch and front viewing window.
- Horn tones and volume by way of a rotary switch.
- The SpectrAlert Advance series includes outdoor notification appliances. Outdoor strobes and horn/strobes (two-wire and four-wire) are available for wall or ceiling. Outdoor horns are available for wall only. All System Sensor outdoor products are rated between -40°F and 151°F (-40°C and 66°C) in wet or dry applications.

Models available:

- Indoor wall-mount: horn, strobe, 2-wire horn/strobe, 4-wire horn/strobe.
- Indoor ceiling-mount: strobe, 2-wire horn/strobe, 4-wire horn/strobe.
- Outdoor wall-mount: horn, strobe, 2-wire horn/strobe, 4-wire horn/strobe.
- Outdoor ceiling-mount: strobe, 2-wire horn/strobe, 4-wire horn/strobe.

Features

- Plug-in design.
- Same mounting plate for wall- and ceiling-mount units.
- Shorting spring on mounting plate for continuity check before installation.
- Captive mounting screw.
- Tamper-resistance capability.
- Field-selectable candela settings on wall and ceiling units: 15, 15/75, 30, 75, 95, 110, 115, 135, 150, 177, 185.
- Automatic selection of 12 or 24 volt operation at 15 and 15/75 candela.
- Outdoor wall and ceiling products.



Indoor Ceiling
Horn/Strobe



Outdoor Ceiling
Strobe



Indoor Wall
Horn/Strobe



Indoor Ceiling
Strobe



Indoor Wall
Horn



Outdoor Wall
Strobe

- Outdoor products rated from -40°F and 151°F (-40°C and 66°C).
- Outdoor products rainproof per UL50 (NEMA 3R) and weatherproof per NEMA 4X, IP56
- Minimal intrusion into the backbox.
- Horn rated at 88+ dbA at 16 volts.
- Rotary switch for tone selection.
- Three horn volume settings.
- Electrically compatible with existing SpectrAlert products.

Engineering Specifications

SpectrAlert Advance horns, strobes, and horn/strobes shall mount to a standard 4.0" x 4.0" x 1.5" (10.16 x 10.16 x 3.81 cm) backbox, 4.0" (10.16 cm) octagonal backbox, or a double-gang backbox. Two-wire products shall also mount to a single-gang 2.0" x 4.0" x 1.875" (5.08 x 10.16 x 4.763 cm) backbox. A universal mounting plate shall be used for mounting ceiling and wall products. The notification appliance circuit wiring shall terminate at the universal mounting plate. Also, SpectrAlert Advance products, when used with the Sync•Circuit™ Module accessory, shall be powered from a non-coded notification appliance circuit output and shall operate on a nominal 12 or 24 volts. When used with the Sync•Circuit Module, 12-volt rated notification appliance circuit outputs shall operate between 9 and 17.5 volts; 24-volt rated notification appliance circuit outputs shall operate between 17 and 33 volts. Indoor SpectrAlert Advance products shall operate between 32°F and 120°F (0°C and 49°C) from a regulated DC, or full-wave-rectified, unfiltered power supply. Strobes and horn/strobes shall have field-selectable candela settings including 15, 15/75, 30, 75, 95, 110, 115, 135, 150, 177, 185.

STROBE

The strobe shall be a System Sensor SpectrAlert Advance Model _____ listed to UL 1971 and shall be approved for fire protective service. The strobe shall be wired as a primary-signaling notification appliance and comply with the Americans with Disabilities Act requirements for visible signaling appliances, flashing at 1 Hz over the strobe's entire operating voltage range. The strobe light shall consist of a xenon flash tube and associated lens/reflector system.

HORN/STROBE COMBINATION

The horn/strobe shall be a System Sensor SpectrAlert Advance Model _____ listed to UL 1971 and UL 464 and shall be approved for fire protective service. The horn/strobe shall be wired as a primary-signaling notification appliance and comply with the Americans with Disabilities Act requirements for visible signaling appliances, flashing at 1 Hz over the strobe's entire operating voltage range. The strobe light shall consist of a xenon flash tube and associated lens/reflector system. The horn shall have three audibility options and an option to switch between a Temporal 3 pattern and a Non-Temporal (continuous) pattern. These options are set by a multiple position switch. On four-wire products, the strobe shall be powered independently of the sounder. The horn on horn/strobe models shall operate on a coded or non-coded power supply.

OUTDOOR PRODUCTS

SpectrAlert Advance outdoor horns, strobes and horn/strobes shall be listed for outdoor use by UL and shall operate between -40°F and 151°F (-40°C and 66°C). The products shall be listed for use with a System Sensor outdoor/weather-proof backbox with half-inch and three-fourths-inch conduit entries.

SYNCHRONIZATION MODULE

The module shall be a System Sensor Sync•Circuit MDL3R or MDL3W listed to UL 464 and shall be approved for fire protective service. The module shall synchronize SpectrAlert strobes at 1 Hz and horns at Temporal 3. Also, while operating the strobes, the module shall silence the horns on horn/strobe models over a single pair of wires. The module shall mount to a 4.688" x 4.688" x 2.125" (11.906 x 11.906 x 5.398 cm) backbox. The module shall also control two Style Y (class B) circuits or one Style Z (Class A) circuit. The module shall synchronize multiple zones. Daisy-chaining two or more synchronization modules together will synchronize all the zones they control. The module shall not operate on a coded power supply.

Strobe Current Draw, UL Maximum (mA RMS)

Candela	8 – 17.5 V		16 – 33 V		
	DC	FWR	DC	FWR	
Standard Candela Range	15	123	128	66	71
	15/75	142	148	77	81
	30	NA	N/A	94	96
	75	NA	NA	158	153
	95	NA	NA	181	176
	110	NA	NA	202	195
	115	NA	NA	210	205
High Candela Range	135	NA	NA	228	207
	150	NA	NA	246	220
	177	NA	NA	281	251
	185	NA	NA	286	258

Operating Specifications

- **Standard operating temperature:** 32°F to 120°F (0°C to 49°C).
- **K Series operating temperature:** -40°F to 151°F (-40°C to 66°C).
- **Humidity range:** 10% to 93% non-condensing (indoor products).
- **Strobe flash rate:** 1 flash per second.
- **Nominal voltage:** regulated 12 VDC/FWR or regulated 24 VDC/FWR. **NOTE:** Full Wave Rectified (FWR) voltage is a non-regulated, time-varying power source that is used on some power supply and panel outputs.
- **Operating voltage range:** 8 V to 17.5 V (12 V nominal); or 16 V to 33 V (24 V nominal). **NOTE:** P, S, PC, and SC products will operate at 12 V nominal only for 15 cd and 15/75 cd.
- **Input terminal wire gauge:** 12 to 18 AWG (3.31 to 0.821 mm²).
- **Ceiling-mount dimensions (including lens):** 6.8" diameter x 2.5" deep (17.3 cm diameter x 6.4 cm deep).
- **Wall-mount dimensions (including lens):** 5.6" H x 4.7" W x 2.5" D (14.2 cm H x 11.9 cm W x 6.4 cm D).
- **Horn dimensions:** 5.6" H x 4.7" W x 1.3" D (14.2 cm H x 11.9 cm W x 3.3 cm D).

Agency Listings and Approvals

The listings and approvals below apply to SpectrAlert Advance Selectable Output Notification Devices. In some cases, certain modules may not be listed by certain approval agencies, or listing may be in process. Consult factory for latest listing status.

- **UL Listed:** S4011 (HR__, HW__, P2__, P4__, PC2__, PC4__ models); S5512 (models SCR, SCRH, SCW, SCWH, SR, SRH, SW, SWH); S3593 (SCRHK, SCRK, SRHK, SRK).
- **ULC Listed:** S4011 (HRA, HRKA); S5512 (typically "A" models, with exception of outdoor strobes). See Canadian data sheet for listings and specifications.
- **FM approved**
- **MEA: 452-05-E**
- **CSFM: 7125-1653:0186** (SCR, SCRH, SCW, SCWH, SR, SRH, SW, SWH); **7300-1653:0188** (P2_, P4_, PC2_, PC4_ modules); **7135-1653:0189** (HR, HRK, HW); **7300-1653:0187** (SCRHK, SCRK, SRHK, SRK).

Horn Current Draw, UL Maximum (mA RMS)

Sound Pattern	dB	8 – 17.5 V		16 – 33 V	
		DC	FWR	DC	FWR
Temporal	High	57	55	69	75
Temporal	Medium	44	49	58	69
Temporal	Low	38	44	44	48
Non-temporal	High	57	56	69	75
Non-temporal	Medium	42	50	60	69
Non-temporal	Low	41	44	50	50
Coded	High	57	55	69	75
Coded	Medium	44	51	56	69
Coded	Low	40	46	52	50

Horn and Horn/Strobe Rotary Switch Setting

Setting	Repetition Rate	dB Level
1	Temporal horn	High
2	Temporal horn	Medium
3	Temporal horn	Low
4	Normal horn	High
5	Normal horn	Medium
6	Normal horn	Low
7*	Externally coded	High
8*	Externally coded	Medium
9*	Externally coded	Low

***NOTE:** Settings 7, 8, and 9 are not available on 2-wire horn/strobe.

Horn and Horn/Strobe Output (dBA)

Switch Position	Sound Pattern	dB	8 – 17.5 V		16 – 33 V	
			DC	FW R	DC	FW R
1	Temporal	High	78	78	84	84
2	Temporal	Medium	74	74	80	80
3	Temporal	Low	71	73	76	76
4	Non-temporal	High	82	82	88	88
5	Non-temporal	Medium	78	78	85	85
6	Non-temporal	Low	75	75	81	81
7*	Coded	High	82	82	88	88
8*	Coded	Medium	78	78	85	85
9*	Coded	Low	75	75	81	81

***NOTE:** Settings 7, 8, and 9 are not available on 2-wire horn/strobe.

Two-Wire Horn/Strobe, **STANDARD** Candela Range (15 – 115 cd), UL Maximum Current Draw (mA RMS)

Input, Sound Pattern, dB Level	8 – 17.5 V		16 – 33 V						
	15	15/75	15	15/75	30	75	95	110	115
DC Input, Temporal, High	137	147	79	90	107	176	194	212	218
DC Input, Temporal, Medium	132	144	69	80	97	157	182	201	210
DC Input, Temporal, Low	132	143	66	77	93	154	179	198	207
DC Input, Non-temporal, High	141	152	91	100	116	176	201	221	229
DC Input, Non-temporal, Medium	133	145	75	85	102	163	187	207	216
DC Input, Non-temporal, Low	131	144	68	79	96	156	182	201	210
FWR Input, Temporal, High	136	155	88	97	112	168	190	210	218
FWR Input, Temporal, Medium	129	152	78	88	103	160	184	202	206
FWR Input, Temporal, Low	129	151	76	86	101	160	184	194	201
FWR Input, Non-temporal, High	142	161	103	112	126	181	203	221	229
FWR Input, Non-temporal, Medium	134	155	85	95	110	166	189	208	216
FWR Input, Non-temporal, Low	132	154	80	90	105	161	184	202	211

Two-Wire Horn/Strobe, **HIGH** Candela Range (135 – 185 cd), UL Maximum Current Draw (mA RMS)

DC Input	16 – 33 V				FWR Input	16 – 33 V			
	135	150	177	185		135	150	177	185
DC, Temporal, High	245	259	290	297	FWR, Temporal, High	215	231	258	265
DC, Temporal, Medium	235	253	288	297	FWR, Temporal, Medium	209	224	250	258
DC, Temporal, Low	232	251	282	292	FWR, Temporal, Low	207	221	248	256
DC, Non-temporal, High	255	270	303	309	FWR, Non-temporal, High	233	248	275	281
DC, Non-temporal, Medium	242	259	293	299	FWR, Non-temporal, Medium	219	232	262	267
DC, Non-temporal, Low	238	254	291	295	FWR, Non-temporal, Low	214	229	256	262

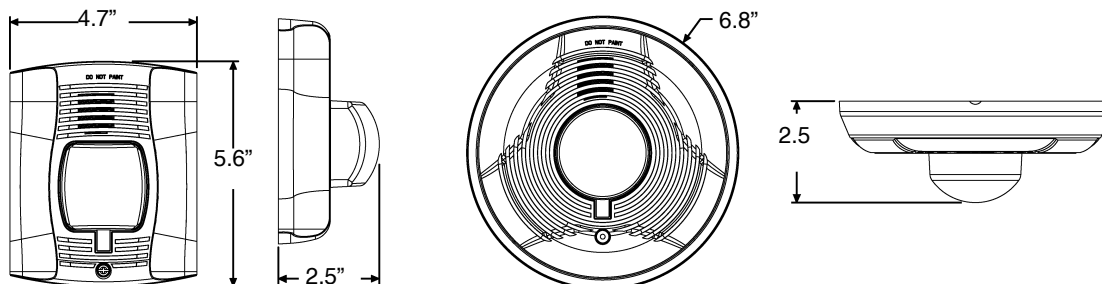

Ordering Information

Model	Description	Model	Description
WALL HORN/STROBES		CEILING HORN/STROBES	
P2R	2-wire horn/strobe, standard cd, red.	PC2R	2-wire horn/strobe, standard cd, red.
P2RH	2-wire horn/strobe, high cd, red.	PC2RH	2-wire horn/strobe, high cd, red.
P2RK	2-wire horn/strobe, standard cd, red, outdoor.	PC2RK	2-wire horn/strobe, standard cd, red, outdoor.
P2RHK	2-wire horn/strobe, high cd, red, outdoor.	PC2RHK	2-wire horn/strobe, high cd, red, outdoor.
P2W	2-wire horn/strobe, standard cd, white.	PC2W	2-wire horn/strobe, standard cd, white.
P2WH	2-wire horn/strobe, high cd, white.	PC2WH	2-wire horn/strobe, high cd, white.
P4R	4-wire horn/strobe, standard cd, red.	PC4R	4-wire horn/strobe, standard cd, red.
P4RH	4-wire horn/strobe, high cd, red.	PC4RH	4-wire horn/strobe, high cd, red.
P4RK	4-wire horn/strobe, standard cd, red, outdoor.	PC4RK	4-wire horn/strobe, standard cd, red, outdoor.
P4RHK	4-wire horn/strobe, high cd, red, outdoor.	PC4RHK	4-wire horn/strobe, high cd, red, outdoor.
P4W	4-wire horn/strobe, standard cd, white.	PC4W	4-wire horn/strobe, standard cd, white.
P4WH	4-wire horn/strobe, high cd, white.	PC4WH	4-wire horn/strobe, high cd, white.
WALL STROBES		CEILING STROBES	
SR	Strobe, standard cd, red.	SCR	Strobe, standard cd, red.
SRH	Strobe, high cd, red.	SCRH	Strobe, high cd, red.
SRK	Strobe, standard cd, red, outdoor.	SCRK	Strobe, standard cd, red, outdoor.
SRHK	Strobe, high cd, red, outdoor.	SCRHK	Strobe, high cd, red, outdoor.
SW	Strobe, standard cd, white.	SCW	Strobe, standard cd, white.
SWH	Strobe, high cd, white.	SCWH	Strobe, high cd, white.
ACCESSORIES		HORNS	
BBS-2A	Backbox skirt, wall, red.	HR	Horn, red.
BBSW-2A	Backbox skirt, wall, white.	HRK	Horn, red, outdoor.
BBSC-2A	Backbox skirt, ceiling, red.	HW	Horn, white.
BBSCW-2A	Backbox skirt, ceiling, white.	ACCESSORIES, continued	
SA-WBB	Weatherproof backbox, wall.	TR-HS	Trim Ring, wall, red, package of 5
SA-WBBC	Weatherproof backbox, ceiling.	TRW-HS	Trim Ring, wall, white, package of 5
WTP	Weatherproof, flush mount plate, red	TRC-HS	Trim Ring, ceiling, red, package of 5
WTPW	Weatherproof, flush mount plate, white	TRCW-HS	Trim Ring, ceiling, white, package of 5
<p>NOTE: "High cd" refers to strobes that include 135, 150, 177, and 185 candela settings. "Standard cd" refers to strobes that include 15, 15/75, 30, 75, 95, 110, and 115 candela settings.</p> <p>NOTE: For strobes and horn/strobes, add suffix "F" for French or "B" for Bilingual.</p> <p>NOTE: All outdoor models ("K(A)" suffix) include a plastic weatherproof backbox.</p> <p>NOTE: Add "-R" to models for weatherproof replacement device (no back box included). Only for use with weatherproof outdoor flush mounting plate, WTP and WTPW.</p> <p>NOTE: Add "P" to model for plain housing. (No "FIRE" marking on cover.)</p>			

SyncCircuit™ is a trademark and NOTIFIER® and SpectraAlert® are registered trademarks of Honeywell International Inc.
 ©2011 by Honeywell International Inc. All rights reserved. Unauthorized use of this document is strictly prohibited.



This document is not intended to be used for installation purposes.
 We try to keep our product information up-to-date and accurate.
 We cannot cover all specific applications or anticipate all requirements.
 All specifications are subject to change without notice.

For more information, contact Notifier. Phone: (203) 484-7161, FAX: (203) 484-7118.
www.notifier.com

SpectrAlert® Advance Mini-Horns

MHR/MHW



Audio/Visual Devices

General

The SpectrAlert® Advance series of mini-horn sounders are designed to simplify installation to provide primary and secondary signaling for fire and security applications.

The MHR and MHW mini-horns operate at 12 and 24 volts and are ideal for hotel, motel or residential fire system applications, where a smaller notification device is desired. The mini-horns offer high and low volume settings, and temporal or non-temporal tones. The horns can be mounted to single gang back boxes for aesthetically sensitive applications. Synchronization is also provided when using the MDL3R, MDL3W module or any Notifier panel with the System Sensor sync protocol.

The MHR and MHW mini-horns can operate between 32 and 120 degrees Fahrenheit from a regulated DC or full-wave rectified, unfiltered power supply. They are listed to Underwriter's Laboratories.

Features

- Standard UL 464 for fire protective signaling systems.
- 12 and 24V operation.
- High and low volume settings.
- Temporal and non-temporal tones.
- Mounts to a single-gang backbox.
- Compatible with MDL sync module.
- Mechanically and electrically compatible with PA400 series Mini-Alert™ sounders.

Specifications

PHYSICAL SPECIALIZATIONS

Dimensions: 4.6"L x 2.9"W x .45"D.

Weight: 2.67 oz.

Operating Temperature Range: 0°C to 49°C (32°F to 120°F).

Mounting: Surface: Deep single-gang backbox (2-3/4" deep);
Flush: Standard 4" x 4" back box.

ELECTRICAL SPECIFICATIONS

Input Terminals: 12 to 18 AWG

Nominal Voltage: Regulated 12DC/FWR or 24DC/FWR

Operating Voltage: 8-33

Operating Voltage with MDL3R/W: 9-33

Architectural/Engineering Specifications

Mini-horns shall be a System Sensor Model MHR or MHW capable of operating at nominal 12 or 24VDC and shall mount to a single gang back box. Mini-horns shall be listed to Underwriter's Laboratories Standard UL464 for fire protective signaling systems. Mini-horns shall operate between 32 and 120 degrees Fahrenheit from a regulated DC, or full-wave rectified, unfiltered power supply. When used with the Sync•Circuit™ Module, 12-volt rated notification appliance circuit outputs shall operate between nine and 17.5 volts; 24-volt rated notification appliance circuit outputs shall operate between 17 and 33 volts.



60296pho1.jpg

Listings and Approvals

These listings and approvals apply to the modules specified in this document. In some cases, certain modules or applications may not be listed by certain approval agencies, or listing may be in progress. Consult factory for listing status.

- **UL Listed:** S4011
- **MEA:** 7-07-E
- **CSFM:** 7135-1653:196
- **FM Approved:** 3028007

Ordering Information

MHR: Mini-Horn; Red.

MHW: Mini-Horn; White.

UL Sound Output and Current Draw Data

SOUNDER OUTPUT (dBA)

Switch Position	Sound Pattern	Volume	8-17.5 VDC	8-17.5 VFWR	Nominal 12 VDC	Nominal 12 VFWR	16-33 VDC	16-33 VFWR
1	Temporal	High	68	67	71	70	78	76
2	Temporal	Low	66	65	69	68	76	75
3	Non-temporal	High	72	71	75	74	80	79
4	Non-temporal	Low	70	69	73	72	78	77

SOUNDER CURRENT DRAW (mA RMS)

Switch Position	Sound Pattern	Volume	8-17.5 V		16-33 V	
			DC	FWR	DC	FWR
1	Temporal	High	12	10	17	15
2	Temporal	Low	10	9	14	13
3	Non-temporal	High	22	17	29	25
4	Non-temporal	Low	17	13	21	19

SpectrAlert® is a registered trademark and Mini-Alert™ is a trademark of Honeywell International Inc.
 ©2010 by Honeywell International Inc. All rights reserved. Unauthorized use of this document is strictly prohibited.



This document is not intended to be used for installation purposes.
 We try to keep our product information up-to-date and accurate.
 We cannot cover all specific applications or anticipate all requirements.
 All specifications are subject to change without notice.



Made in the U.S. A.

For more information, contact Notifier. Phone: (203) 484-7161, FAX: (203) 484-7118.
www.notifier.com

7788F/7744F Series

Wireless Fire Alarm Communicators for AES-IntelliNet



Features – All models

- UL Listed commercial fire alarm applications.
- Meets NFPA 72 requirements
- Direct reporting to AES receiver across IntelliNet wireless mesh network
- Each Subscriber acts as transmitter/receiver/repeater
- Simple and fast activation on network
- On board status LEDs for easy set up
- 8 programmable zone inputs – 7788F
- 4 programmable zone inputs and 4 reverse polarity inputs – 7744F
- Easy programming via AES handheld programmer or PC
- Rugged metal housing ideal for any commercial fire alarm application

Models 7788F/7744F-ULP with IntelliPro Fire also includes

- IntelliPro Fire transmits full alarm data from virtually any fire alarm panel digital communicator
- Alarm format support for Contact ID, Pulse, or Bosch Modem IIe or Modem IIIa2
- Easy installation in AES subscriber
- Operates in applications with or without a phone line

Advanced Wireless Alarm Monitoring

The AES-IntelliNet mesh radio network offers unmatched reliability and speed in delivering wireless alarm signals to a central station without third party fees or reliance on networks owned by companies outside the security and fire alarm industry. AES-7788F/7744F Series Smart Subscriber Transceivers provide the wireless communication link between the fire alarm panel and the central station receiver. The 7788F/7744F Series is ideal for most commercial fire alarm applications. Each 7788F/7744F Series Subscriber is housed in a full sized, red, locked, steel cabinet and supports a range of alarm panel inputs including EOL fire, EOL supervised, and direct voltage from the panel (non-fire applications).

Supervised Operation

AES Smart Subscribers offer fully supervised operation that includes monitoring of operating power (both primary AC power and battery backup) and the connection to the radio network. Each Subscriber “checks in” with the AES central station receiver at least once every 24 hours. The supervision check in time can be set for as often as once per minute and, because the central station owns the wireless network, there is no additional cost for air time to transmit supervisory signals.

Full Data Reporting from Alarm Panel Digital Dialer

Models 7788F-ULP and 7744F-ULP come equipped with an IntelliPro Fire Full Data Module (AES-7794) which enables reporting of full alarm data captured from the fire alarm panel's digital communicator. IntelliPro Fire supports most alarm communication formats including Contact ID, Pulse, as well as Bosch Modem IIe and Modem IIIa2.



Wireless mesh networking is an innovative technology adopted by many industries with applications that need to communicate data over a large geographic area with a high level of reliability at a low total cost of ownership.

The advanced design and 2-way communications capability provides easy installation, expansion, and management when compared to alternative communication methods, both wired and wireless.

7788F/7744F Series



Technical Specifications

7788F/7744F Series Subscribers

Dimensions

- 13.25"H x 8.5"W x 4.3"D
(34cm H x 21.5cm W x 11cm D)

Weight

- Approx. 7 pounds (3.2 kilograms), excludes battery.

Radio Frequency

- Standard Frequency Range: 450-470MHz (others available)
- Output Power - 2 Watts (others available)

Antenna

- Included 2.5 db tamper resistant antenna mounts on enclosure
- Multiple remote antenna options available

Power Input

- 16.5VAC, 40VA (transformer not included)

Backup Battery

- Will charge 12V battery up to 7.5 AH. Requires 12VDC 7.5 AH battery for UL 864.

Alarm Signal Inputs (subscriber)

- 7788F – 8 individually programmable zones
- 7744F - 4 individually programmable zones and 4 reverse polarity inputs

UL Standards

- UL 864 Edition 9 – Standard for Control Units and Accessories for Fire Alarm Systems
- UL 365 – Standard for Police Station Connected Burglar Alarm Units and Systems
- UL 1681 – Standard for Central Station Burglar Alarm Units

Antenna Cut / Communication

Trouble Output

- Form C relay; fail secure; rated for 24 VDC 1A resistive

Reset Button

- Located on main circuit board.

Operating Temperature

- 0° to 50° C (32° to 122°F)

Storage Temperature

- -10° to 60° C (14° to 140°F)

Relative Humidity

- 0 to 85% RHC, Non Condensing

AES-7794 IntelliPro Fire

Input / Output Connections

- RJ11 connection to AES subscriber for module data and power
- RJ11 connector for Handheld Programmer/PC programming
- RJ31X Telco connections - T and R both in and out via terminal strip and RJ45
- Alarm Panel digital communicator T and R both in and out via terminal strip and RJ45
- Trouble output: Form C relay detects if Subscriber is off the network

Alarm Formats

- Support for Contact ID and Pulse formats as well as Modem IIe and Modem IIIa2 converted to CID

Size

- 2.8 x 5.0 inches (7.1cm x 12.7cm)

Power Requirements

- 12 VDC nominal - primary and backup power provided by the AES 7788F/7744F or other Subscriber

How to Order

Model	Description
7744F	4 Zone Fire Alarm Subscriber with 4 reverse polarity inputs
7744F-ULP	7744F Fire Alarm Subscriber with IntelliPro Fire full data module
7788F	8 Zone Fire Alarm Subscriber
7788F-ULP	7788F Fire Alarm Subscriber with IntelliPro Fire full data module

Optional Accessories

7041E	Subscriber Handheld Programmer
7794	IntelliPro Fire Full Data Module



AES-IntelliNet™ is the industry leader in delivering high quality wireless mesh networks to the fire and security industry in commercial, corporate, government, and educational applications with its broad line of products and advanced network management tools. Users of AES-IntelliNet networks have gained significant revenue, communications, and cost advantages while meeting the high standards of reliability required for the fire and security industry. AES-IntelliNet alarm monitoring systems are deployed at hundreds of thousands of locations in over 150 countries.



For more information

Call 800-AES-NETS (800-237-6387)

AES Corporation | 285 Newbury Street | Peabody, MA 01960 USA

Tel. +1 978-535-7310 | Fax +1 978-535-7313 | Email info@aes-intellinet.com

Web www.aes-intellinet.com

Copyright 2011 AES Corporation
AES-IntelliNet is a registered trademark
of AES Corporation

7788F-7744F/9/7/11R3

Multi-Voltage Conventional Relays



Miscellaneous

General

Notifier's multi-voltage conventional relays are used for high-current switching applications such as fan and damper assembly control, door control, air handling unit controls, and other types of system interfacing.

The R-10T(A)/20T(A) and R-14T(A)/R-24T(A) models are multi-voltage relays with terminal strip field wiring connections, mounting track and hardware. The R-10T(A) is a single FORM-C (SPDT) relay with a red activation LED, and the R-14T(A) is a 4-gang 1 FORM-C (SPDT) relay with 4 red activation LEDs. The R-20T(A) is a single 2 FORM-C (DPDT) relay with red activation LED, and the R-24T(A) is a 4-gang 2 FORM-C (DPDT) relay with 4 red activation LEDs.

The R-10E(A)/R-20E(A) and R-14E(A)/R-24E(A) are similar to the T series track mount relays, but they are mounted into a steel enclosure. The enclosure has a removable front cover that provides easy access and a LED viewing hole on the top of the cover.

PR-1(A)/PR-2(A)/PR-3(A) are epoxy encapsulated multi-voltage relays. They are single pole double throw relays that use a red LED as a visible indication of relay coil energization. PR-3 is identical to PR-2 except it has an extra pair of wires for redundant power input.

Model EOLR-1(A) is an epoxy encapsulated single pole single throw, normally open relay that can be used as an end of line device in fire alarm systems, e.g. to supervise power supplies.

Specifications

R-10T(A)/R-14T(A)/R-20T(A)/ R-24(A)T

Operating Voltage Range: 18-35 VDC, 18-35 VAC, 115 VAC, 230 VAC.

Operating Current: 23 mA @ 24 VDC, 59 mA @ 24 VAC, 150 mA @ 120 VAC, 180 mA @ 240 VAC [R-10T(A)/R-14T(A)].

40 mA DC max. @ 24 VDC, 24 VAC, 92 mA @ 24 VAC, 220 mA @ 120 VAC, 260 mA @ 240 VAC [R-20T(A)/R-24T(A)]

Humidity Range: 10% to 93% (non-condensing).

Dimensions: R-10T(A)/ R-20T(A): 2.5"L x 3.35"W x 1.2"H.

R-14T(A)/R-24T(A): 10"L x 3.35"W x 1.2"H.

Operating Temperature: -40° F to 158° F (-40°C to 70°C)

Contact Ratings: 24 VDC: 7A with L/R = 5 mS.
120 VAC: 10 A.
120 VAC: 1/6 HP.
230 VAC: 7 A.

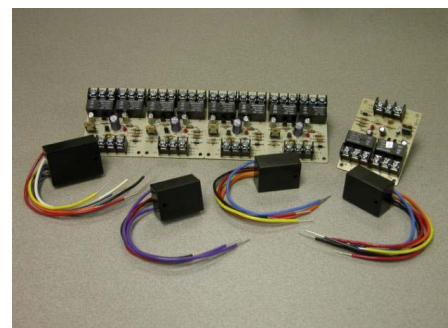

Multi-Voltage Conventional Relays

7015dn015g101

R-10E(A)/ R-14E(A)/R-20E(A)/ R-24E(A)

Operating Voltage Range: 18-35 VDC, 18-35 VAC, 115 VAC, 230 VAC.

Operating Current: 23 mA DC max. @ 24 V, 59 mA @ 24 VAC, 150 mA @ 120 VAC, 180 mA @ 240 VAC [R-10E(A)/R-14E(A)].

-40 mA DC max. @ 24 VDC, 24 VAC, 115 VAC, 230 VAC (R-20E/R-24E).

Humidity Range: 10% to 93% (non-condensing).

Dimensions: R-10E(A)/R-20E(A): 5.1"L x 3.75"W x 2.5"H.

R-14E(A)/R-24E(A): 11"L x 5.3"W x 2.5"H.

Operating Temperature: -40° F to 158° F (-40° C to 70° C).

Contact Ratings: 24 VDC: 7 A with L/R = 5mS.
120 VAC: 10 A.
120 VAC: 1/6 HP.
230 VAC: 7 A.

PR-1(A)

Operating Voltage Range: 18-35 VDC, 18-35 VAC, 120 VAC.

Operating Current: 15 mA DC max. @ 24 VDC, 24 VAC, 120VAC.

Humidity Range: 10% to 93% RH.

Dimensions: 0.87" H x 2.01" W x 1.42" D.

Operating Temperature: -40° F to 158° F (-40° C to 70° C).

Contact Ratings: 24 VDC: 7 A with LR = 5 mS.
120 VAC: 7 A max. (0.35 PF).
250 VAC: 10 A resistive.
30 VDC: 10 A resistive.

Wire Length: 8" minimum.

PR-2(A)/PR-3(A)

Operating Voltage Range:	10 to 40 VDC.
Operating Current:	30 mA DC max.
Humidity Range:	10% to 93% RH.
Dimensions:	0.91" H x 1.65" W x 1.22" D.
Operating Temperature:	-40° F to 158° F (-40° C to 70° C).
Contact Ratings:	120 VAC: 10 A (resistive load). 120 VAC: 7 A max. (0.35 PF). 250 VAC: 10 A max. (resistive load). 30 VDC: 10 A max. (resistive load).
Wire Length:	8" minimum.

EOLR-1(A)

Operating Voltage Range:	9 to 40 VDC.
Operating Current:	20 mA DC max.
Humidity Range:	10% to 93% RH.
Operating Temperature:	-22° F to 140° F (-30° C to 60° C).
Contact Ratings:	120 VAC: 0.5 A max. (resistive load). 30 VDC: 3 A max. (resistive load).
Wire Length:	8" minimum.

Agency Listings and Approvals

In some cases, certain modules may not be listed by certain approval agencies, or listing may be in process. Consult factory for latest listing status.

- UL/ULC Listed: S3705
- ULC Listed: CS669
- MEA: 419-04-E
- CSFM: 7300-1653:173

PRODUCT LINE INFORMATION

NOTE: "A" suffix indicates ULC listed model.

PR-1(A): Epoxy encapsulated single pull double throw (SPDT) relay. It also uses a red LED as a visible indication of relay coil energization with pigtailed.

PR-2(A): Epoxy encapsulated single pull double throw (SPDT) activated by 10 to 40 VDC. It uses a red LED as a visible indication of relay coil energization with pigtailed.

PR-3(A): Epoxy encapsulated single pull double throw (SPDT) activated by 10 to 40 VDC. It contains an additional black and red wire for redundant power input with pigtailed.

EOLR-1(A): Epoxy encapsulated single pull single throw (SPST) normally open relay that is activated by 9 to 40 VDC. This relay can be used as an end of line device in fire alarm systems, e.g., to supervise power supplies.

R-10T(A): Single (SPDT) relay with a red activation LED.

R-14T(A): 4-gang (SPDT) relay with 4 red activation LEDs.

R-20T(A): Single (DPDT) relay with a red activation LED.

R-24T(A): 4-gang (DPDT) relay with 4 red activation LEDs.

The R-10E(A)/R-20E(A) and R-14E(A)/R-24E(A) are similar to the T series track mount relays, but they are mounted into a steel enclosure. The enclosure has a removable front cover that provides easy access and a LED viewing hole on the top of the cover.

R-10E(A): Single (SPDT) relay mounted into a steel enclosure, 1 red activation LED.

R-14E(A): 4-gang (SPDT) relay mounted into a steel enclosure, 4 red activation LEDs.

R-20E(A): Single (DPDT) relay mounted into a steel enclosure, 1 red activation LED.

R-24E(A): 4-gang (DPDT) relay mounted into a steel enclosure, 4 red activation LEDs.



7015pr1.jpg

PR-1(A)



7015pr2.jpg

PR-2(A)

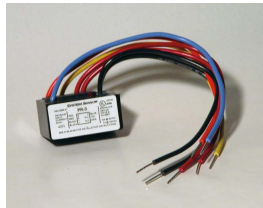

7015pr3.jpg

PR-3(A)

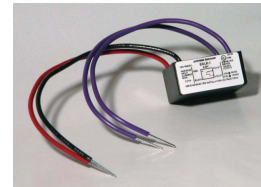

7015eolr1.jpg

EOLR-1(A)

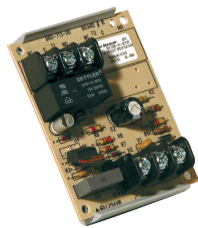

7015r10t.jpg

R-10T(A)

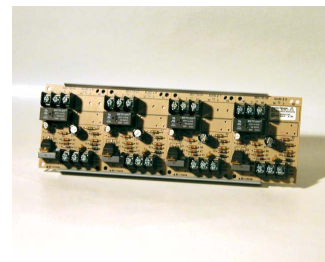

7015r14t.jpg

R-14T(A)

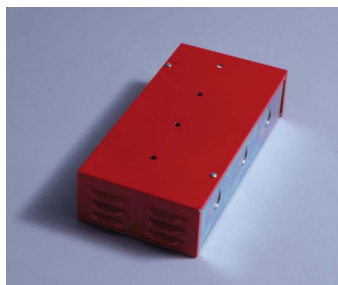

7015r20-24e.jpg

**R-20E(A) & R-24E(A)
Enclosures**

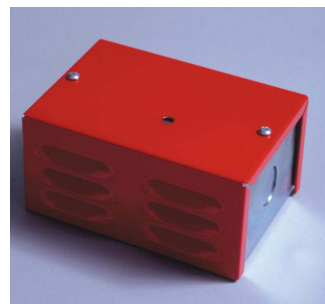

7015r10-14e.jpg

**R-10E(A) & R-14E(A)
Enclosures**

©2013 by Honeywell International Inc. All rights reserved. Unauthorized use of this document is strictly prohibited.



This document is not intended to be used for installation purposes.
We try to keep our product information up-to-date and accurate.
We cannot cover all specific applications or anticipate all requirements.
All specifications are subject to change without notice.

For more information, contact Notifier. Phone: (203) 484-7161, FAX: (203) 484-7118.
www.notifier.com

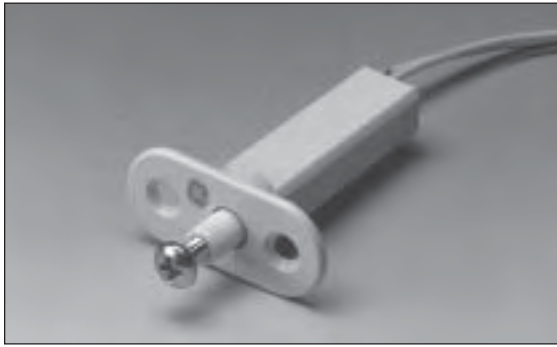

Recessed Pin Plunger

3010 Series

Applications

- Model 3015 available in plate mount or clip mount configuration
- Model 3025 plunger self-adjusts to proper reach
 - Pulling out on plunger shuts switch
 - Disconnection while servicing equipment is unnecessary

General Specifications

Enclosure	ABS plastic
Temperature Range	-40°F to 150°F (-40°C to 65°C)
Environmental	Contact Housing is made of flame-retardant ABS plastic. Reed switch is protected and held in place by a polyurethane potting material
NEMA Rating	1
Protection Class	IP 62
Response Time	1 msec max.
Life Cycles	100,000 Under Full Load, 10,000,000 Under Dry Circuit
Lead Types/O.D.	#22 wire / 0.05" (0.15cm)
Color Choices	Natural (N), Mahogany (M)
UL Listed	All Models

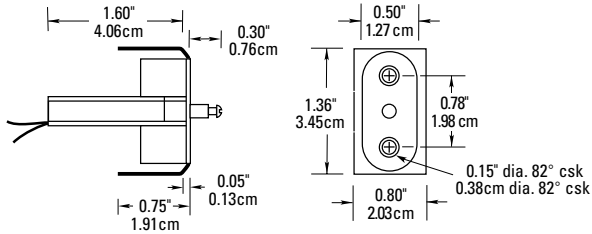

3012 Clip Mount Plunger

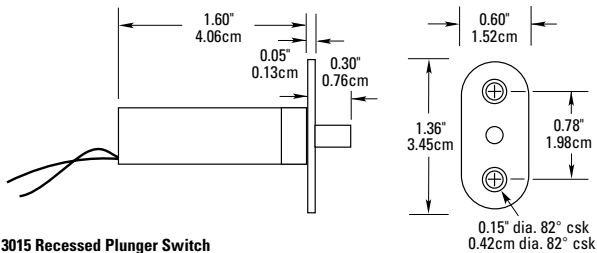

3015 Recessed Plunger Switch

Includes: 1- Adjustable #6 x 32 1/2" Phillips screw

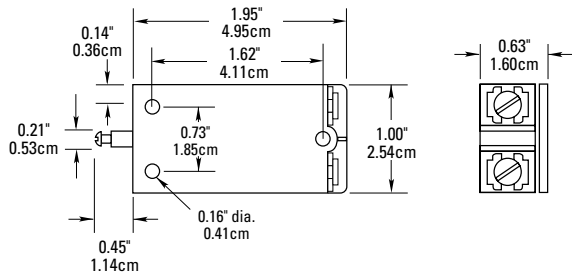

3025 Tamper Switch



Order Information

Electrical Specifications

Part Number	Contact Configuration	Load Rating (AC/DC)	Switching Voltage (AC/DC)	Switching Current (AC/DC)	Contact Resistance	Lead Length
3012-M, N	N.O.	7.5W/VA	100V	0.5A	0.2 Ohms	1'
3015-M, N	N.O.	7.5W/VA	100V	0.5A	0.2 Ohms	1'
3027-M, N	SPDT	3W/VA	30V	0.25A	0.2 Ohms	1'
3025T-M, N	N.O.	7.5W/VA	100V	0.5A	0.2 Ohms	#6 Screw Terminal

Warning— Each electrical rating is an individual maximum and cannot be exceeded!

¹ Configuration with plunger out.

AC Transformers & 12 VDC Plug In Power Supply

ELK-TRG1640 & TRG2440

- Auto-Resetting (PTC) Fused Secondary
- Green Power On LED
- Grounding Prong & Terminal
- Electrical outlet mounting tab
- UL Listed
- Lifetime Limited Warranty
- Wire Strain Relief

Specifications

- Input Voltage: 120 VAC, 60 Hz, .43A
- Output Voltage: TRG1640 = 16.5 Volts A.C.
TRG2440 = 24 Volts A.C.
- Output Power: TRG1640 = 45 VA
TRG2440 = 40 VA
- Size: 4.14"H x 2.74"W x 2.2"D
(105mm x 70mm x 56mm)
- Color: White

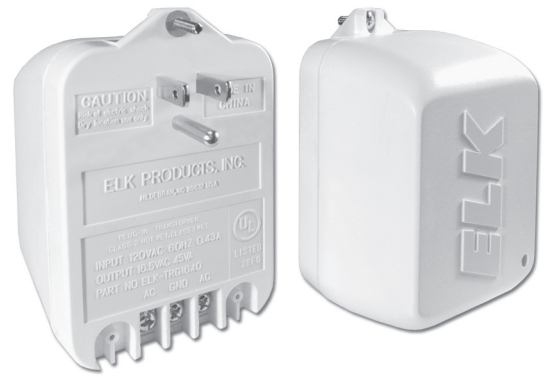

LIFETIME WARRANTY
Grounding Terminal
Power LED
Strain Relief
All in One!

ELK-P1216

The ELK-P1216 is a general purpose 12 Volts D.C. Switching Plug-In Power Supply. It is ideal for alarm, access control, and CCTV applications requiring up to 1.5 Amps. The power pack plugs into 100 to 120 Volts A.C., and supplies regulated 12 Volts D.C. to a standard 2.1mm power plug.

Features

- Switching Power Supply
- Regulated 12 Volts D.C. Output
- Six foot cord and standard
- 2.1mm x 5.5mm x 9mm plug (center is positive)
- UL Listed
- Efficiency Level: V
- Lifetime Limited Warranty

Specifications

- DC Output Voltage: 12 Volts D.C.
- Current Rating: 1.5 Amps
- AC Input Voltage Range: 100-120 @ 47~63 Hz
- Size: 1.75"H x 1.375"W x 2.75"D



12 Volts D.C.
Plug-In Power Supply
Slimline Design
RoHS Compliant

**NO
EXCUSES!**



FAD



FIRE ALARM DOCUMENTS

The FAD is the perfect fit to meet the demanding code requirements today. SAE's number one goal is to manufacture code compliant solutions and this product allows you to do just that. NFPA 72 2010 section 6.2.2.1 states, "A record of installed software and firmware version numbers shall be maintained at the location of the fire alarm control unit."

This durable 16 gauge steel enclosure with a solid piano hinge and key lock will keep all of your code required documents in one safe place. With a 4GB USB flash drive it stores your fire alarm software safe and secure eliminating the occurrences of the software not being on site when technicians arrive to service the system. Along with your fire alarm software you can store your test & inspection documents, service records, manuals & AS built drawings for the system. Using a standard USB B connector it allows you to plug in with any standard SB printer cable to upload or download information.

The FDB is designed to hold critical manuals and documents with a durable steel retainer. It has designated hooks to organize key rings and hold important business cards for easy access and reference. Inside the cover it has a organized note table that allows for documentation for passwords and other critical system information.

Standard Features:

- Installed with a 4 gig digital flash drive with USB B connector
- 2 Key ring hooks to hold system keys
- Business card holder for key contacts
- Overall Dimensions are 12" x 13" tall and 2 ¼ deep
- 16 gauge steel box and cover for security
- Durable powercoat baked on finish other colors available
- Standard ¾" cat 30 key lock other lock assemblies available
- Solid stainless steel piano hinge
- Permanently screened white ink 1" high "Fire Alarm Documents"
- Legend sheet for passwords and system information



**ISO 9001
REGISTERED
COMPANY**



ACEBOX

Space Age Electronics, Inc.
www.1sae.com
800.486.1723 Toll Free
508.485.0966 Local
508.485.4740 Fax

Specifications:

The fire alarm documents box (FAD) shall be constructed of 18 gauge cold rolled steel. It shall have a red powder coat epoxy finish. The cover shall be permanently screened with 1" high lettering "FIRE ALARM DOCUMENTS" with white indelible ink. The access door shall be locked with a 3/4" barrel lock and the hinge shall be a solid width 12" stainless steel piano hinge. The enclosure will supply 4 mounting holes. Inside the enclosure will accommodate standard 8 1/2 x 11 manuals and loose document records that will be protected within the enclosure. A legend sheet will be permanently attached to the door for system required documentation, key contacts and system information. The FAD will have securely mounted inside a minimum of 4 Gigabyte digital flash memory drive with a standard USB B connector for uploading and downloading information. The drive shall not be accessible without tools to any person whom gains access to the records. The enclosure shall also provide 2 key ring holders with a location to mount standard business type cards for key contact personnel.



USB Storage Interface Requires Standard USB-B Connector

Key Ring Hooks

Business Card Holder

For replacement forms order PIN: EA0316 (Qty. 10)

Property Information	Minimum Required Documentation (SIG-FUN)
Name of property: _____ Address: _____ Description of property: _____ Occupancy type: _____	(Reference NFPA-72 2013 Section 7.2.1) 1 Written narrative providing intent and system description □ NA □ Enclosed □ All Location
Certifications and Approvals 16.1 System Installation Contractor: This system, as specified herein, has been installed and tested according to all NFPA standards cited herein. Signed: _____ Date: ____/____/____ Organization: _____ Title: _____ Phone: _____	2 Riser diagram □ NA □ Enclosed □ All Location
16.5 Authority Having Jurisdiction: I have witnessed a satisfactory acceptance test of this system and find it to be installed and operating properly in accordance with its approved plans and specifications, with its approved sequence of operations, and with all NFPA standards cited herein. Signed: _____ Date: ____/____/____ Organization: _____ Title: _____ Phone: _____	3 Floor plan layout showing location of all devices and control equipment □ NA □ Enclosed □ All Location
Equipment Information ID No 1: _____ Serial: _____ Access code: _____ ID No 2: _____ Serial: _____ Access code: _____	4 Sequence of operation in either an input/output matrix or narrative form □ NA □ Enclosed □ All Location
	5 Equipment technical data sheets □ NA □ Enclosed □ All Location
	6 Manufacturers published instructions, including operation and maintenance instruction □ NA □ Enclosed □ All Location
	7 Battery calculations (where batteries are provided) □ NA □ Enclosed □ All Location
	8 Voltage drop calculations for notification appliance circuits □ NA □ Enclosed □ All Location
	9 Completed record of inspection and testing in accordance with 7.6.6 and 7.8.2 □ NA □ Enclosed □ All Location
	10 Completed record of completion in accordance with 7.5.6 and 7.8.2 □ NA □ Enclosed □ All Location
	11 Copy of site specific software, where applicable □ NA □ Enclosed □ All Location
	12 Record (as built) drawings □ NA □ Enclosed □ All Location
	13 Periodic inspection, testing, and maintenance documentation in accordance with Section 7.6 □ NA □ Enclosed □ All Location
	14 Records, record retention, and record maintenance in accordance with 7.7 □ NA □ Enclosed □ All Location
	Signed: _____ Date: ____/____/____

Space Age Electronics, Inc. 58 Chocksett Road Sterling, MA 01564 800-486-1723 www.1sae.com LT10644 Rev. 1

Legend sheet for storing system information including contacts, sign-off, maintenance & test information, and alternate locations of additional records.

Ordering Information:

Part # Description

SSU00685 Fire Alarm Storage Cabinet RED

SSU00686 Custom screening with your Logo

Check out our Infinity line eFAD single gang 2 Gig digital storage solutions (IAMEFAD)



Space Age Electronics, Inc.
www.1sae.com
800.486.1723 Toll Free
508.485.0966 Local
508.485.4740 Fax

No Excuses, Just Solutions!

This document is subject to change without notice, see doc # ED0479 for legal disclaimer

High Security Industrial/Government Key Vault

Recessed Mount
with Face Flange



Surface Mount
with optional
Tamper Switch



Knox-Vault™ key boxes are used in larger businesses, industrial properties, public buildings and universities. The heavy-duty, high security 4400 Series Knox-Vault protects and stores building keys, access cards and floor plans for emergency entry. The vault also provides secure storage for other internal and external applications.

Features and Benefits

- Holds up to 50 keys in the large interior compartment
- Ensures high security with UL[®] Listed Medeco lock(s)
- Includes Knox-Coat[®] that is four times better than standard powder coat
- Resists moist conditions with a weather resistant door gasket
- Colors: Black, Dark Bronze or Aluminum
- Weight: Surface mount - 28 lbs.
Recessed mount - 29 lbs.

Options

- Alarm tamper switches (UL Listed)
- Additional rust and corrosion protection (Aluminization)
- Recessed Mounting Kit (RMK) for recessed models only
- Custom vault depth available
- Dual lock configuration
- Inside switch for use on electrical doors, gates and other electrical equipment

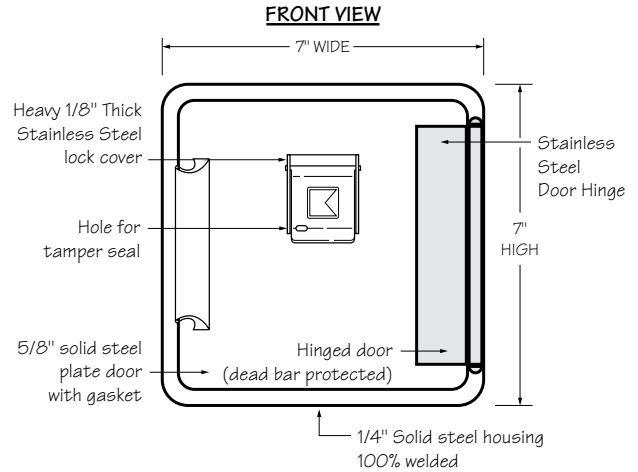

4400 Surface Mount

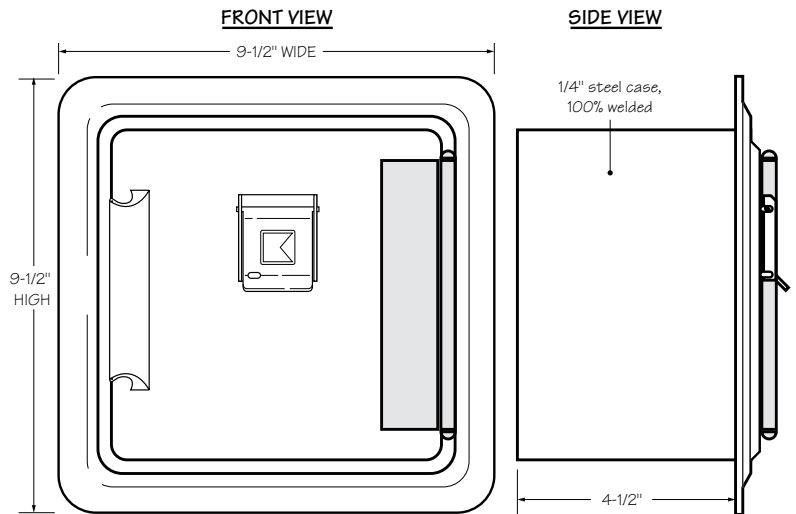

4400 Recessed Mount

Ordering Specifications

To insure procurement and delivery of the 4400 Series Knox-Vault, it is suggested that the following specification paragraph be used:

KNOX-VAULT surface/recessed mount, with/without UL Listed tamper switches. 1/4" plate steel housing, 5/8" thick steel door with interior gasket seal and stainless steel hinge. Vault and lock UL Listed. Lock has 1/8" thick stainless steel dust cover with tamper seal mounting capability. Vault has anti-theft re-locking mechanism with drill resistant hard-plate lock protector.

Exterior Dimensions: Surface mount - 7"H x 7"W x 5"D
Recessed mount flange - 9 1/2"H x 9 1/2"W

Lock: UL Listed. Double-action rotating tumblers and hardened steel pins accessed by a biased cut key.

Finish: Knox-Coat[®] proprietary finishing process
Finish Color - Black, Dark Bronze or Aluminum

P/N: 4400 Series Knox-Vault (mfr's cat. ID)

Mfr's Name: **KNOX COMPANY**

**Suggested minimum mounting height
6 feet above ground**

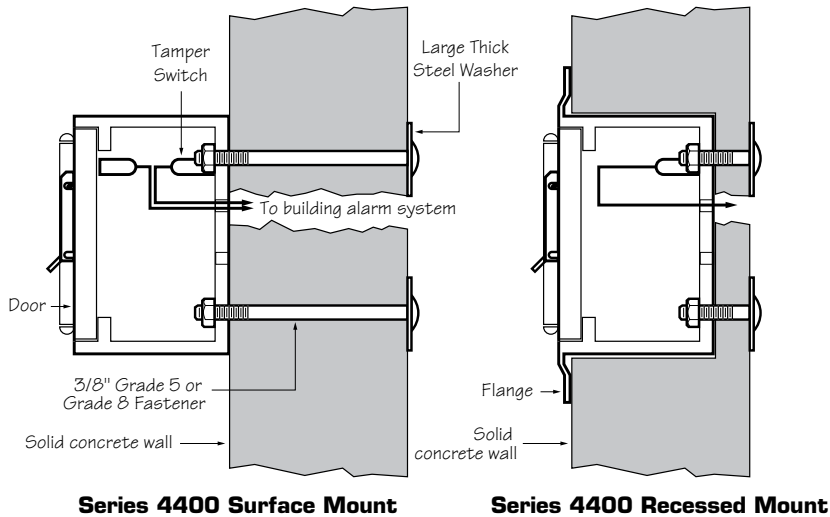

Recessed Mounting Kit

The 4400 Recessed Mounting Kit (RMK) is used for recessed models only. It contains a shell housing and mounting hardware to be cast-in-place in new concrete or masonry construction. After construction is completed, the Knox-Vault mounts inside the recessed shell housing. The RMK may only be used in new concrete or masonry construction.

Installation In Cast Concrete

The optional Recessed Mounting Kit is for use in new concrete or masonry construction only. The kit includes a shell housing and mounting hardware to be cast-in-place. The KNOX-VAULT is mounted into the shell housing after construction is completed.

Rough-In Dimensions

8 1/2"H x 8 1/2"W x 7"D

IMPORTANT: Care should be taken to insure that the front of the RMK shell housing, including the cover plate and screw heads, is flush with the finish wall. The RMK must be plumbed to insure vertical alignment of the vault.

INSIDE VIEW

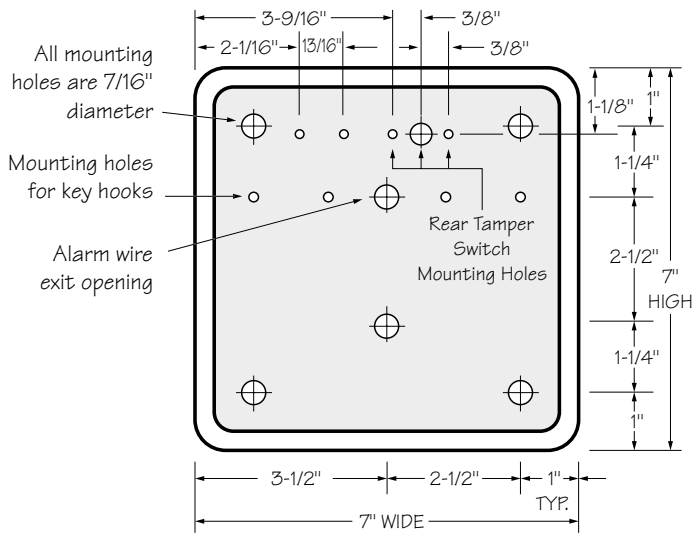

Attention: KNOX-VAULT™ is a very strong device that **MUST** be mounted properly to ensure maximum security and resist physical attack.

Knox® Rapid Entry System

The Knox Company manufactures a complete line of high security products including Knox-Box key boxes, key vaults, cabinets, key switches, padlocks, locking FDC caps, plugs and electronic master key security systems. For more information or technical assistance, please call Customer Service at 1-800-552-5669.

Recessed Mounting Using Recessed Mounting Kit (RMK)

