

City of Portland, Maine - Building or Use Permit Application

389 Congress Street, 04101 Tel: (207) 874-8703, Fax: (207) 874-8716

Permit No: 01-1262	Issue Date: NOV 20 2001	CBL: 300 C014001
-----------------------	----------------------------	---------------------

Location of Construction: 67 W Commonwealth Dr	Owner Name: Cabana Christopher L &	Owner Address: 67 W Commonwealth Dr	Phone: 207-797-7413
Business Name:	Contractor Name: Glamour Pools	Contractor Address: 23 Brighton Rd Westbrook	Phone: 2078789060
Lessee/Buyer's Name	Phone:	Permit Type: Additions - Dwellings	Zone: R-3

Past Use: Single Family	Proposed Use: Single Family	Permit Fee: \$174.00	Cost of Work: \$25,000.00	CEO District: 1
----------------------------	--------------------------------	-------------------------	------------------------------	--------------------

Proposed Project Description:
Install inground pool, fence and ~~filter house~~

FIRE DEPT: <input type="checkbox"/> Approved <input type="checkbox"/> Denied N/A Signature: N/A	INSPECTION: Use Group: U Type: BOCA 1999 Signature: T. MURPHY
---	--

PEDESTRIAN ACTIVITIES DISTRICT (P.A.D.)

Action: Approved N/A Approved w/Conditions Denied

Signature: N/A Date:

Permit Taken By: gad	Date Applied For: 10/12/2001	Zoning Approval	
-------------------------	---------------------------------	------------------------	--

- This permit application does not preclude the Applicant(s) from meeting applicable State and Federal Rules.
- Building permits do not include plumbing, septic or electrical work.
- Building permits are void if work is not started within six (6) months of the date of issuance. False information may invalidate a building permit and stop all work..

<p>Special Zone or Reviews</p> <input type="checkbox"/> Shoreland <input type="checkbox"/> Wetland <input type="checkbox"/> Flood Zone <input type="checkbox"/> Subdivision <input type="checkbox"/> Site Plan Maj <input type="checkbox"/> Minor <input type="checkbox"/> MM <input type="checkbox"/> Date: 11/20/01	<p>Zoning Appeal</p> <input type="checkbox"/> Variance <input type="checkbox"/> Miscellaneous <input type="checkbox"/> Conditional Use <input type="checkbox"/> Interpretation <input type="checkbox"/> Approved <input type="checkbox"/> Denied Date:	<p>Historic Preservation</p> <input checked="" type="checkbox"/> Not in District or Landmark <input type="checkbox"/> Does Not Require Review <input type="checkbox"/> Requires Review <input type="checkbox"/> Approved <input type="checkbox"/> Approved w/Conditions <input type="checkbox"/> Denied Date: 11/20/01
--	---	---

CERTIFICATION

I hereby certify that I am the owner of record of the named property, or that the proposed work is authorized by the owner of record and that I have been authorized by the owner to make this application as his authorized agent and I agree to conform to all applicable laws of this jurisdiction. In addition, if a permit for work described in the application is issued, I certify that the code official's authorized representative shall have the authority to enter all areas covered by such permit at any reasonable hour to enforce the provision of the code(s) applicable to such permit.

SIGNATURE OF APPLICANT	ADDRESS	DATE	PHONE
RESPONSIBLE PERSON IN CHARGE OF WORK, TITLE		DATE	PHONE



2/22/01 - Left message w/owners - need more info on protection of pool area and construction specs on 8'x8' filter house. (TM)

1/20/01 - Filter House ~~will~~ will be done under a separate permit - owner is aware. TM

See notes for dump done 5/20/02 & 5/28/02 on duplicate permit attached

5/23/02 - Setbacks OK - underground electrical OK

9/30/04 New owner - Final all ok
Tom M
Except Pentry door alarm not operating
new owner will get repaired & call for dump
Ⓢ

(pool)
05/20/02 grounding & trench (ok) ready to
backfill ~~now~~

5/23/02 - checked electrical trench - OK to backfill

5/28/02 - OK Setbacks for pool only - OK

01-1262

All Purpose Building Permit Application

If you or the property owner owes real estate or personal property taxes or user charges on any property within the City, payment arrangements must be made before permits of any kind are accepted.

Location/Address of Construction: 67 West Commonwealth Drive

Total Square Footage of Proposed Structure _____ Square Footage of Lot _____

Tax Assessor's Chart, Block & Lot Chart# 300 Block# C Lot# 014 Owner: Christopher L Cabana & Stephanie J Sylvester Telephone: 207-797-7413

Lessee/Buyer's Name (If Applicable) NA Applicant name, address & telephone: Christopher L Cabana & Stephanie J Sylvester 67 West Commonwealth Drive Portland ME 2077977413 Cost Of Work: \$ 25,000 Fee: \$ 174.00

Current use: Home
If the location is currently vacant, what was prior use: _____
Approximately how long has it been vacant: _____
Proposed use: _____
Project description: installation of in-ground pool, fence and small filter building (8x8)

Contractor's name, address & telephone: James E. Erskine Glamour Pools 2 Lisbon Rd 207-784-6538 Lisbon, ME
Who should we contact when the permit is ready: Chris Cabana & Stephanie Sylvester
Mailing address: 67 West Commonwealth Drive Portland, Maine 04103 Phone: 207 797-7413

IF THE REQUIRED INFORMATION IS NOT INCLUDED IN THE SUBMISSIONS THE PERMIT WILL BE AUTOMATICALLY DENIED AT THE DISCRETION OF THE BUILDING/PLANNING DEPARTMENT, WE MAY REQUIRE ADDITIONAL INFORMATION IN ORDER TO APPROVE THIS PERMIT.

I hereby certify that I am the Owner of record of the named property, or that the owner of record authorizes the proposed work and that I have been authorized by the owner to make this application as his/her authorized agent. I agree to conform to all applicable laws of this jurisdiction. In addition, if a permit for work described in this application is issued, I certify that the Code Official's authorized representative shall have the authority to enter all areas covered by this permit at any reasonable hour to enforce the provisions of the codes applicable to this permit.

Signature of applicant: Christopher L Cabana Date: 10/10/01

This is not a permit, you may not commence ANY work until the permit is issued

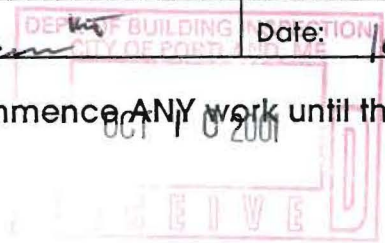

Gary 10/10

A Pool for Every Lot Size & Shape

Oval

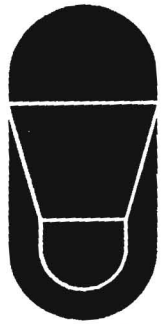

Sizes:
 14' x 28'
 16' x 32'
 16' x 34'
 16' x 36'
 18' x 36'
 20' x 40'

Muskoka

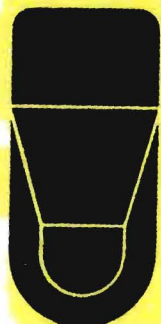

2' Radius
Corners

Sizes:
 14' x 28'
 16' x 32'
 16' x 34'
 16' x 36'
 18' x 36'
 20' x 40'

Tahiti



Sizes:
 20' x 34'
 22' x 36'
 24' x 40'

Oasis

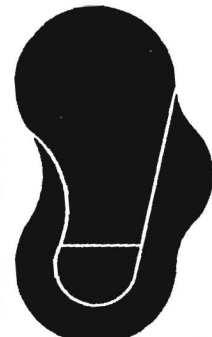

Sizes:
 16' x 34'
 18' x 36'
 18' x 38'
 20' x 40'
 20' x 42'

Rectangle

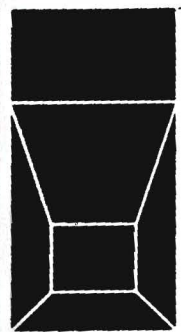

6" Radius
Corners

Sizes:
 14' x 28'
 16' x 32'
 16' x 34'
 16' x 36'
 18' x 36'
 20' x 40'

Bahama



2' Radius
Corners

Sizes:
 14' x 28'
 16' x 32'
 16' x 34'
 16' x 36'
 18' x 36'
 20' x 40'

Bermuda



2'10" 45 Deg.
Corners

Sizes:
 14' x 28'
 16' x 32'
 16' x 34'
 16' x 36'
 18' x 36'
 20' x 40'

Florida



4' Radius
Corners

Sizes:
 14' x 28'
 16' x 32'
 16' x 34'
 16' x 36'
 18' x 36'
 20' x 40'

Kidney



Sizes:
 14' x 28'
 16' x 28'
 16' x 32'
 16' x 34'
 18' x 34'
 18' x 36'
 20' x 40'

Fiji



Sizes:
 16' x 28'
 16' x 30'
 16' x 32'
 18' x 31'
 18' x 33'
 20' x 35'
 20' x 37'
 22' x 39'
 22' x 41'

Arizona II



2' Radius
Corners

Sizes:
 14' x 31'
 16' x 38'
 18' x 40'
 20' x 41'

Texas

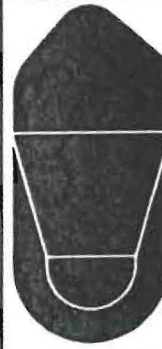

4' Radius
Corners

Sizes:
 14' x 30'
 16' x 37'
 18' x 39'
 20' x 40'

Bahama Full-L



2' Radius
Corners

Sizes:
 14' x 28'
 16' x 32'
 16' x 34'
 16' x 36'
 16' x 38'
 18' x 36'
 18' x 38'
 20' x 40'
 20' x 42'

Bermuda Full-L



2'10" 45 Deg.
Corners

Sizes:
 14' x 28'
 16' x 32'
 16' x 34'
 16' x 36'
 16' x 38'
 18' x 36'
 18' x 38'
 20' x 40'
 20' x 42'

Roman I



1' Radius
Corners
(6" rad.
available)

Sizes:
 14' x 28'
 16' x 32'
 16' x 34'
 16' x 36'
 18' x 36'
 20' x 40'

Venetian

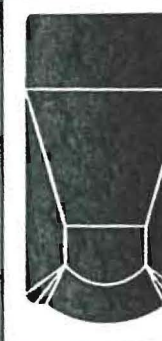

Sizes:
 14' x 28'
 16' x 32'
 16' x 34'
 16' x 36'
 18' x 36'
 20' x 40'

KAFKO

Select Your Shape And Size

KAFKO's numerous selection of shapes and sizes allows you to create a luxurious and inviting setting for many great get togethers. Many more shapes and sizes are available. Four, six and eight foot walk-in staircases are a popular option for most pools. More information on custom shapes can be requested from your dealer.

Scale: 1 square = 2 ft

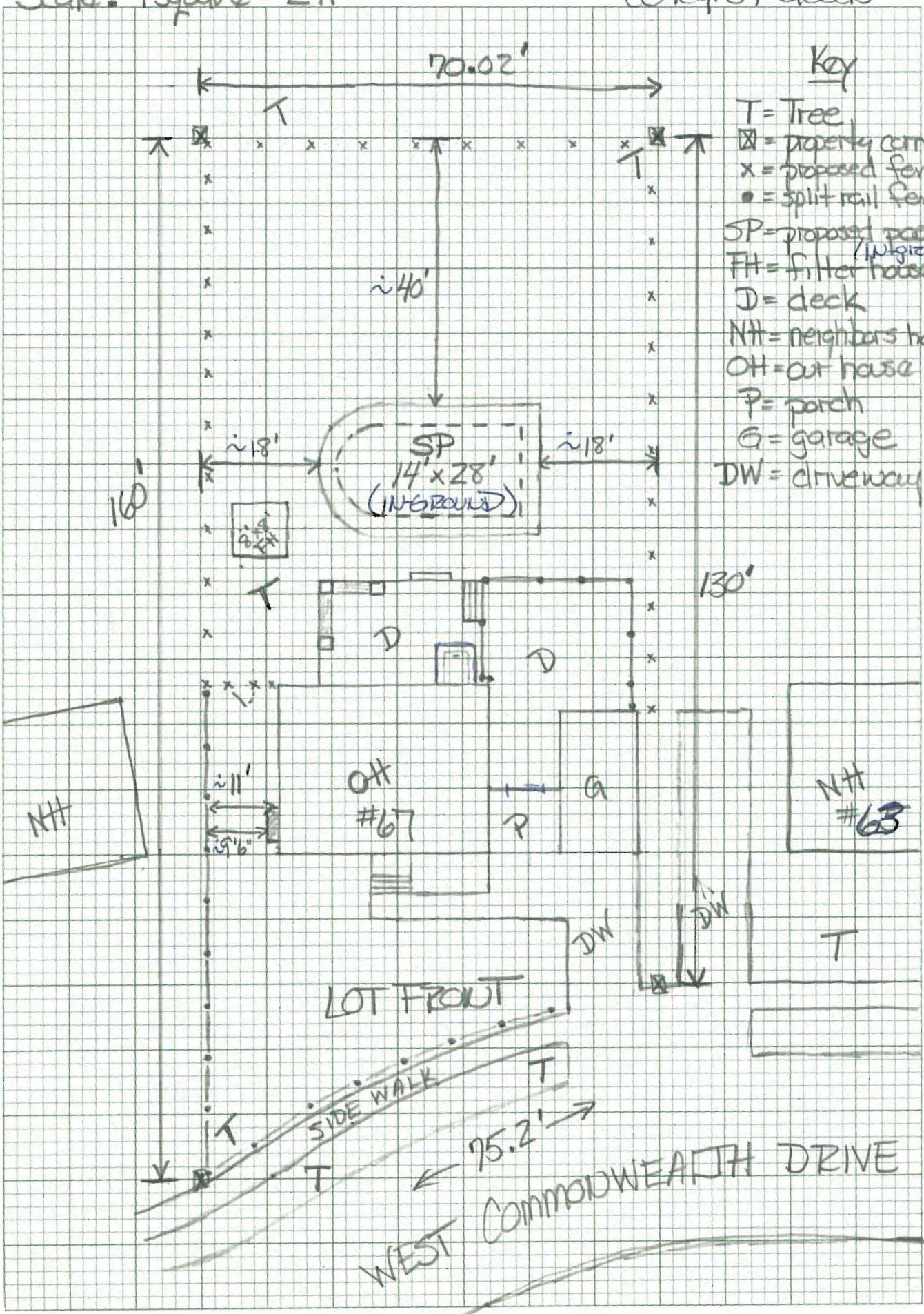

- Key**
- T = Tree
 - ☒ = property corners
 - X = proposed fence (6')
 - = split rail fence
 - SP = proposed pool (inground)
 - FH = filter house
 - D = deck
 - NH = neighbors house
 - OH = out house
 - P = porch
 - G = garage
 - DW = driveway

DUPLICATE

GENERAL RECEIPT

CITY OF PORTLAND, MAINE

DEPARTMENT Inspection DATE 10/10/01

RECEIVED FROM Chris Lawrence

ADDRESS 67 West Commercial

Drive

UNIT	ITEM	REVENUE CODE	DOLLAR AMOUNT
	<u>Building fee</u>		<u>17450</u>
	<u>CR 300 (2014)</u>		

CASH CHECK OTHER TOTAL 17450

RECEIVED BY [Signature]

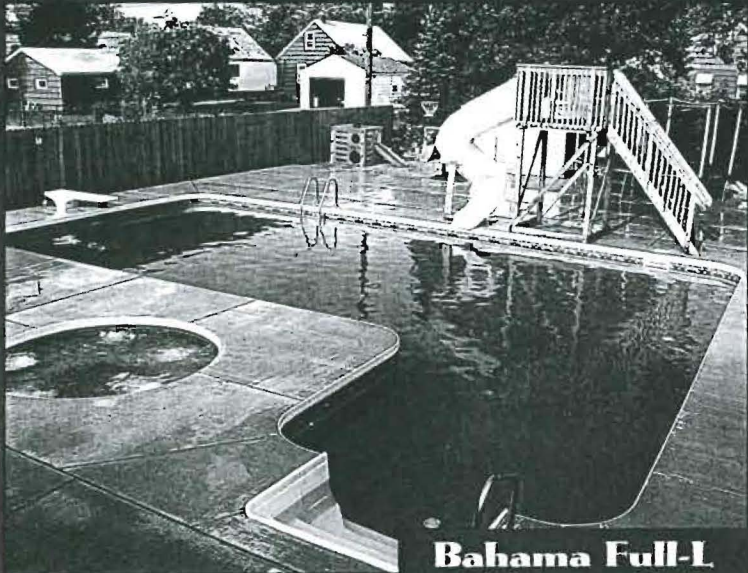

Bahama Full-L

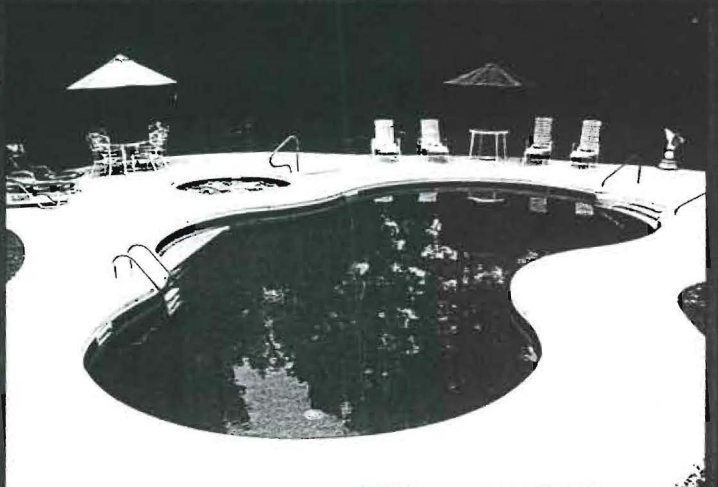

Oasis



Custom

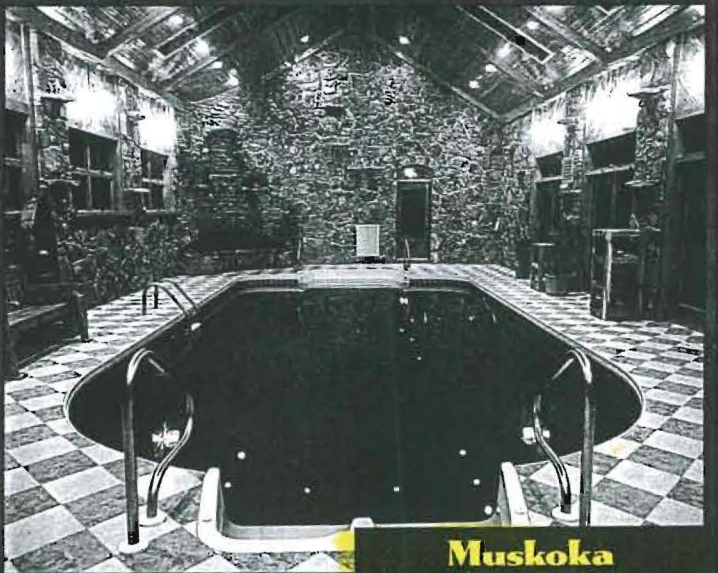

Muskoka



KAFKO MANUFACTURING

Glamour
and more

MEMBER



NATIONAL SPA & POOL INSTITUTE

See Below

Maxima Deluxe Latch Set (w/Slip-Lock)

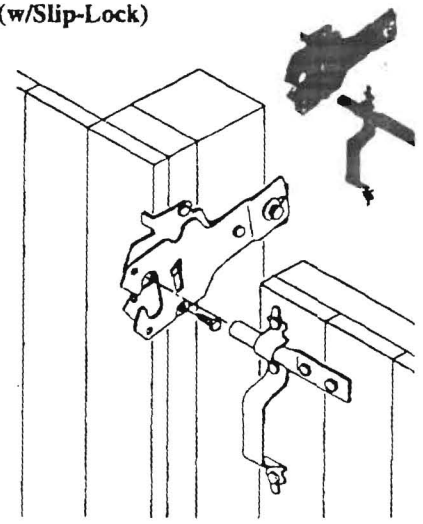

See Below

*296X	176.00	---	---	Black	P/B w/o scr.	20 Ea.	45
*296-SX	179.60	---	---	Black	P/B w/scr.	20 Ea.	49
*297X	182.60	---	---	Black	Cd. w/scr.	10 Ea.	---

The "Max" deluxe latch comes complete with striker, handle and Slip-Lock.

296-S

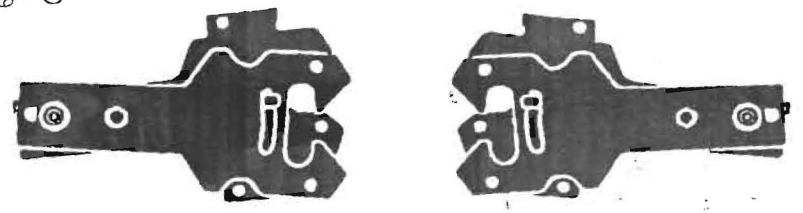

Above latch is completely reversible (without disassembly) for right or left opening gates.

Pool

$$\begin{array}{r}
 14' \times 28' \\
 \hline
 14 \\
 112 \\
 \hline
 28 \\
 392 \text{ sqft}
 \end{array}$$

concrete

$$\begin{array}{r}
 3' \times 20' \\
 \hline
 3 \\
 60 \text{ sqft} \times 2 = 120 \text{ sqft}
 \end{array}$$

$$\begin{array}{r}
 3' \times 34' \\
 \hline
 3 \\
 102 \text{ sqft} \times 2 = 204 \text{ sqft}
 \end{array}$$

392 sqft
pool

324 sqft
concrete