

DISPLAY THIS CARD ON PRINCIPAL FRONTAGE OF WORK CITY OF PORTLAND

Please Read Application And Notes, If Any, Attached

DEPARTMENT OF BUILDING INSPECTION

PERMIT

Permit Number: 050929

PERMIT ISSUED

AUG 10 2005

This is to certify that STRAIGHT WILLIAM L & LISSA S. JTS/Four Seasons Sunroom

has permission to add Sunroom in rear of property

AT 57 BELFORT ST

City of Portland Permit No. 299 D02100

provided that the person or persons, firm or corporation accepting this permit shall be bound by all of the provisions of the Statutes of Maine and of the Ordinances of the City of Portland regulating the construction, maintenance and use of buildings and structures, and of the application on file in this department.

Apply to Public Works for street line and grade if nature of work requires such information.

Notification of inspection must be given and written permission procured before this building or part thereof is altered or closed-in. **48 HOUR NOTICE IS REQUIRED.**

A certificate of occupancy must be procured by owner before this building or part thereof is occupied.

OTHER REQUIRED APPROVALS

Fire Dept. _____

Health Dept. _____

Appeal Board _____

Other _____

Department Name

[Handwritten Signature]
8/3/05
Director - Building & Inspection Services

PENALTY FOR REMOVING THIS CARD

BUILDING PERMIT INSPECTION PROCEDURES

Please call 874-8703 or 874-8693 to schedule your inspections as agreed upon

Permits expire in 6 months, if the project is not started or ceases for 6 months.

The Owner or their designee is required to notify the inspections office for the following inspections and provide adequate notice. Notice must be called in 48-72 hours in advance in order to schedule an inspection:

By initializing at each inspection time, you are agreeing that you understand the inspection procedure and additional fees from a "Stop Work Order" and "Stop Work Order Release" will be incurred if the procedure is not followed as stated below.

A ~~Pre-con~~struction Meeting will take place upon receipt of your building permit.

- Footing/Building** Location Inspection: Prior to pouring concrete
- Re-Bar Schedule Inspection: Prior to pouring concrete
- 2/Foundation Inspection: Prior to placing ANY backfill.
- Framing/Rough** Plumbing/Electrical: Prior to any insulating or drywalling
- Final** Certificate of Occupancy: Prior to any occupancy of the structure or use. **NOTE:** There is a \$75.00 fee per inspection at this point.

Certificate of Occupancy is not required for certain projects. Your inspector can advise you if your project requires a Certificate of Occupancy. All projects DO require a final inspection

If any of the inspections do not occur, the project cannot go on to the next phase, REGARDLESS OF THE NOTICE OR CIRCUMSTANCES.

CERIFICATE OF OCCUPANICES MUST BE ISSUED AND PAID FOR, BEFORE THE SPACE MAY BE OCCUPIED

William King
Signature of Applicant/Designee

8/10/05
Date

[Signature]
Signature of Inspections Official

8.10.05
Date

CBL: 289 D21

Building Permit #: 080929

City of Portland, Maine - Building or Use Permit Application
 389 Congress Street, 04101 Tel: (207) 874-8703, Fax: (207) 874-8716

| | | |
|-----------------------|----------------------------|-----------------------|
| Permit No: 05-0929 | Issue Date: AUG 10 2005 | Phone: 299 D02 001 |
|-----------------------|----------------------------|-----------------------|

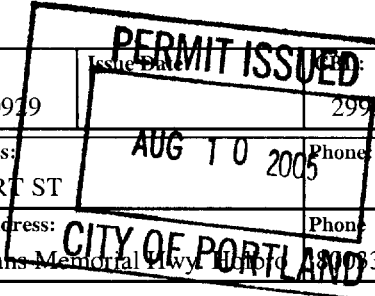

| | | | |
|--|---|---|-----------------------|
| Location of Construction: 57 BELFORT ST | Owner Name: STRAIGHT WILLIAM L & MELIS | Owner Address: 57 BELFORT ST | Phone: 299 D02 001 |
| Business Name: | Contractor Name: Four Seasons Sunrooms | Contractor Address: 5005 Veterans Memorial Hwy, Portland | Phone: 8399184 |
| Lessee/Buyer's Name | Phone: | Permit Type: Additions - Dwellings | Zone: R-3 |

| | | | | |
|--|---|--|--|--------------------|
| Past Use: Single Family Home | Proposed Use: Single Family Home / add Sunroom in rear of property | Permit Fee: \$363.00 | Cost of Work: \$38,000.00 | CEO District: 5 |
| Proposed Project Description: add Sunroom in rear of property | | FIREDEFT: <input type="checkbox"/> Approved <input type="checkbox"/> Denied Signature: <i>N/A</i> | INSPECTION: Use Group: R-3 Type: 5B Signature: <i>IRC 2003</i> | |

| | |
|--|------------------------------|
| PEDESTRIAN ACTIVITIES DISTRICT (P.A.D.) | |
| Action: <input type="checkbox"/> Approved <input type="checkbox"/> Approved w/Conditions <input type="checkbox"/> Denied | Signature: _____ Date: _____ |

| | | |
|-----------------------------|---------------------------------|------------------------|
| Permit Taken By: Idobson | Date Applied For: 07/11/2005 | Zoning Approval |
|-----------------------------|---------------------------------|------------------------|

| | | | |
|--|---|---|--|
| 1. This permit application does not preclude the Applicant(s) from meeting applicable State and Federal Rules. 2. Building permits do not include plumbing, septic or electrical work. 3. Building permits are void if work is not started within six (6) months of the date of issuance. False information may invalidate a building permit and stop all work.. | Special Zone or Reviews <input type="checkbox"/> Shoreland <input type="checkbox"/> Wetland <input type="checkbox"/> Flood Zone <input type="checkbox"/> Subdivision <input type="checkbox"/> Site Plan Maj <input type="checkbox"/> Minor <input type="checkbox"/> MM <input type="checkbox"/> Date: <i>0/3/05</i> | Zoning Appeal <input type="checkbox"/> Variance <input type="checkbox"/> Miscellaneous <input type="checkbox"/> Conditional Use <input type="checkbox"/> Interpretation <input type="checkbox"/> Approved <input type="checkbox"/> Denied Date: _____ | Historic Preservation <input checked="" type="checkbox"/> Not in District or Landmark <input type="checkbox"/> Does Not Require Review <input type="checkbox"/> Requires Review <input type="checkbox"/> Approved <input type="checkbox"/> Approved w/Conditions <input type="checkbox"/> Denied Date: <i>0/3/05</i> |
|--|---|---|--|

CERTIFICATION

I hereby certify that I am the owner of record of the named property, or that the proposed work is authorized by the owner of record and that I have been authorized by the owner to make this application as his authorized agent and I agree to conform to all applicable laws of this jurisdiction. In addition, if a permit for work described in the application is issued, I certify that the code official's authorized representative shall have the authority to enter all areas covered by such permit at any reasonable hour to enforce the provision of the code(s) applicable to such permit.

 SIGNATURE OF APPLICANT ADDRESS DATE PHONE

 RESPONSIBLE PERSON IN CHARGE OF WORK, TITLE DATE PHONE

All Purpose Building Permit Application

If you or the property owner owes real estate or personal property taxes or user charges on any property Within the City, payment arrangements must be made before permits of any kind are accepted.

| | | | |
|--|--|---|----------------------------|
| 2- | | 1 | 3 |
| Total Square Footage of Proposed Structure <u>130 30 ft</u> | | Square Footage of Lot | |
| Tax Assessor's Chart, Block & Lot Chart# <u>29010</u> Block# <u>21-22</u> Lot# | | Owner: <u>Wm + Melissa Straight 57 Belfort St Portland ME 04103</u> | Telephone: <u>878-5916</u> |
| Lessee/Buyer's Name (If Applicable) | Applicant name, address & telephone: <u>Wm + Melissa Straight 57 Belfort St Portland, ME</u> | Cost Of Work: \$ <u>38,000</u> Fee: \$ <u>363</u> | |
| Current use: <u>Back yard SFH</u> | | | |
| If the location is currently vacant, what was prior use: _____ | | | |
| Approximately how long has it been vacant: _____ | | | |
| Proposed use: <u>Sun Room 10x14 Sunroom</u> | | | |
| Project description: | | | |
| Contractor's name, address & telephone: <u>LI Seasons Services</u> | | | |
| Who should we contact when the permit is ready: <u>Wm + Melissa Straight</u> | | | |
| Mailing address: <u>57 Belfort St Portland ME 04103</u> | | | |
| We will contact you by phone when the permit is ready. You must come in and pick up the permit and review the requirements before starting any work, with a Plan Reviewer. A stop work order will be issued and a \$100.00 fee if any work starts before the permit is picked up. PHONE: <u>878-5916</u> | | | |

IF THE REQUIRED INFORMATION IS NOT INCLUDED IN THE SUBMISSIONS THE PERMIT WILL BE AUTOMATICALLY DENIED AT THE DISCRETION OF THE BUILDING/PLANNING DEPARTMENT, WE MAY REQUIRE ADDITIONAL INFORMATION IN ORDER TO APPROVE THIS PERMIT.

I hereby certify that I am the Owner of record of the named property, or that the owner of record authorizes the proposed work and that I have been authorized by the owner to make this application as his/her authorized agent. I agree to conform to all applicable laws of this jurisdiction. In addition, if a permit for work described in this application is issued, I certify that the Code Official's authorized representative shall have the authority to enter all areas covered by this permit at any reasonable hour to enforce the provisions of the codes applicable to this permit.

| | |
|---|----------------------|
| Signature of applicant: <u>Melissa Straight</u> | Date: <u>7-11-05</u> |
|---|----------------------|

This is NOT a permit, you may not commence ANY work until the permit is issued.
If you are in a Historic District you may be subject to additional permitting and fees with the Planning Department on the 4th floor of City Hall



230 SUN & STARS: CURVED EAVE ENGINEERING INFORMATION

EFFECTIVE DATE: 6-02LD

| SERIES 330 PATIO ROOM MODELS | TRUSS & GLAZING BAR O.C. SPACING | RAFTER BAR TYPE | ALLOWABLE ROOF LOAD (psf) | LB MODELS | | | GG MODELS | | | DH MODELS | | |
|------------------------------------|-------------------------------------|--------------------|---------------------------------|---------------------|------------|------------|---------------------|------------|------------|---------------------|------------|-----|
| | | | | ALLOWABLE WIND LOAD | | | ALLOWABLE WIND LOAD | | | ALLOWABLE WIND LOAD | | |
| | | | | EXPOSURE | | | EXPOSURE | | | EXPOSURE | | |
| B (mph) | C (mph) | D (mph) | B (mph) | C (mph) | D (mph) | B (mph) | C (mph) | D (mph) | B (mph) | C (mph) | D (mph) | |
| CSU-3 | 2' - 6 5/8" | 4GBA | 175 | 200 | 180 | 160 | 180 | 160 | 145 | 170 | 150 | 140 |
| CSU-5 | 2' - 6 5/8" | 4GBA | 60 | 180 | 160 | 145 | 180 | 160 | 145 | 165 | 150 | 135 |
| CSU-8 | 2' - 6 5/8" | 4GBA | 36 | 135 | 120 | 110 | 135 | 120 | 110 | 135 | 120 | 110 |
| | 2' - 6 5/8" | 4HBA | 50 | 145 | 130 | 115 | 145 | 130 | 115 | 145 | 130 | 115 |
| CSU-10 | 2' - 6 5/8" | 4HBA | 20 | 110 | 100 | 90 | 110 | 100 | 90 | 110 | 100 | 90 |
| | 2' - 6 5/8" | 4GB+4RS | 55 | 150 | 135 | 120 | 150 | 135 | 120 | 150 | 135 | 120 |
| CSU-13 | 2' - 6 5/8" | 4GB+4RS | 42 | 150 | 135 | 120 | 150 | 135 | 120 | 125 | 110 | 100 |
| | 2' - 6 5/8" | 4HB+4RS | 48 | 150 | 135 | 120 | 150 | 135 | 120 | 125 | 110 | 100 |
| CSU-15 | 2' - 6 5/8" | 4GB+4RS | 32 | 135 | 120 | 110 | 135 | 120 | 110 | 120 | 105 | 95 |
| | 2' - 6 5/8" | 4HB+4RS | 40 | 150 | 135 | 120 | 135 | 120 | 110 | 120 | 105 | 95 |
| csu-3 | 3' - 0 5/8" | 4GBA | 145 | 195 | 175 | 160 | 170 | 150 | 140 | 160 | 145 | 130 |
| CSU-5 | 3' - 0 5/8" | 4GBA | 50 | 170 | 150 | 140 | 170 | 150 | 140 | 155 | 140 | 125 |
| CSU-8 | 3' - 0 5/8" | 4GBA | 30 | 130 | 115 | 105 | 130 | 115 | 105 | 130 | 115 | 105 |
| | 3' - 0 5/8" | 4HBA | 41 | 140 | 125 | 115 | 140 | 125 | 115 | 140 | 125 | 115 |
| CSU-10 | 3' - 0 5/8" | 4HBA | 15 | 100 | 90 | 80 | 100 | 90 | 80 | 100 | 90 | 80 |
| | 3' - 0 5/8" | 4GB+4RS | 170 | 170 | 150 | 140 | 170 | 150 | 140 | 150 | 135 | 120 |
| csu-13 | 3' - 0 5/8" | 4GB+4RS | 150 | 150 | 135 | 120 | 150 | 135 | 120 | 125 | 110 | 100 |
| | 3' - 0 5/8" | 4HB+4RS | 150 | 150 | 135 | 120 | 150 | 135 | 120 | 125 | 110 | 100 |
| csu-15 | 3' - 0 5/8" | 4GB+4RS | 125 | 125 | 110 | 100 | 125 | 110 | 100 | 120 | 105 | 95 |
| | 3' - 0 5/8" | 4HB+4RS | 140 | 140 | 125 | 115 | 140 | 125 | 115 | 120 | 105 | 95 |

NOTE: EXPOSURE B - RESIDENTIAL AREAS, EXPOSURE C - OPEN TERRAIN AREAS, EXPOSURE D - AREAS WITHIN 1500' OF OCEAN

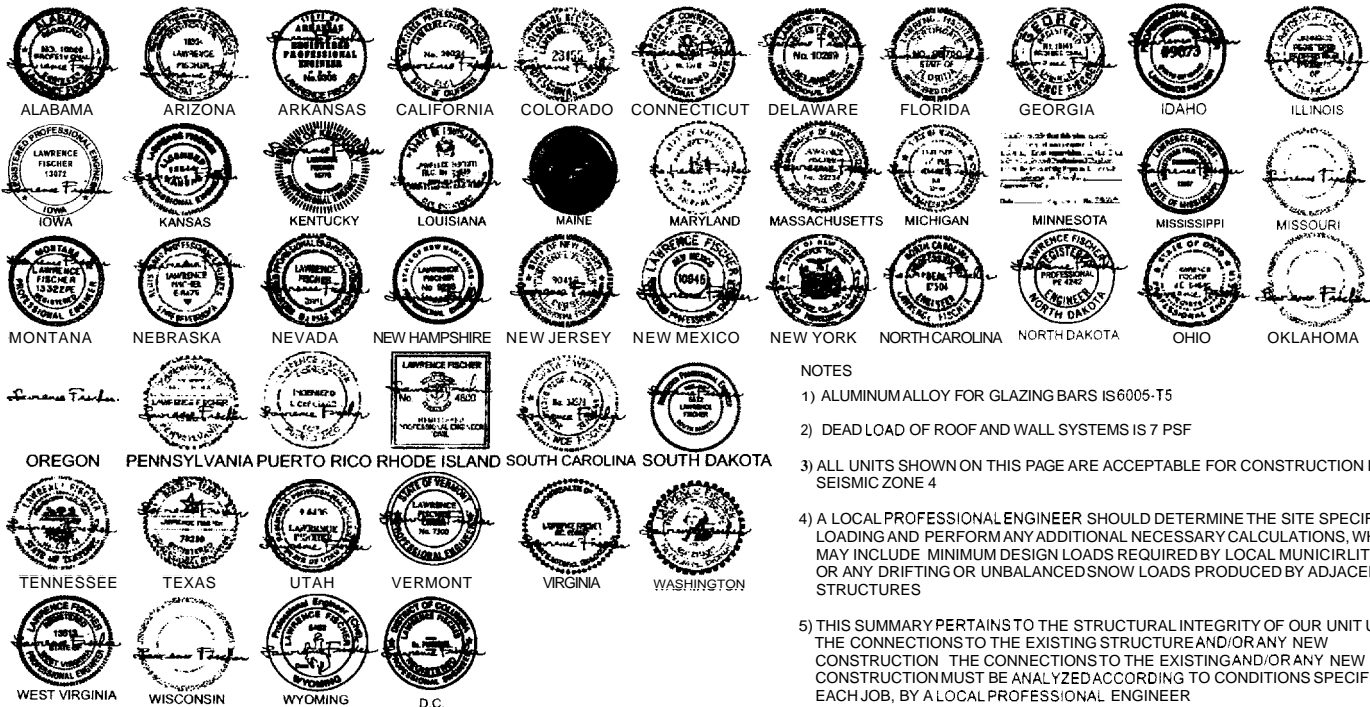

NOTES

- 1) ALUMINUM ALLOY FOR GLAZING BARS IS 6005-T5
- 2) DEAD LOAD OF ROOF AND WALL SYSTEMS IS 7 PSF
- 3) ALL UNITS SHOWN ON THIS PAGE ARE ACCEPTABLE FOR CONSTRUCTION IN SEISMIC ZONE 4
- 4) A LOCAL PROFESSIONAL ENGINEER SHOULD DETERMINE THE SITE SPECIFIC LOADING AND PERFORM ANY ADDITIONAL NECESSARY CALCULATIONS, WHICH MAY INCLUDE MINIMUM DESIGN LOADS REQUIRED BY LOCAL MUNICIPALITIES, OR ANY DRIFTING OR UNBALANCED SNOW LOADS PRODUCED BY ADJACENT STRUCTURES
- 5) THIS SUMMARY PERTAINS TO THE STRUCTURAL INTEGRITY OF OUR UNIT UP TO THE CONNECTIONS TO THE EXISTING STRUCTURE AND/OR ANY NEW CONSTRUCTION. THE CONNECTIONS TO THE EXISTING AND/OR ANY NEW CONSTRUCTION MUST BE ANALYZED ACCORDING TO CONDITIONS SPECIFIC TO EACH JOB, BY A LOCAL PROFESSIONAL ENGINEER
- 6) ENGINEERS CERTIFICATION: I, LAWRENCE FISCHER, CERTIFY THAT THESE ENGINEERING SPECIFICATIONS HAVE BEEN PREPARED UNDER MY DIRECT SUPERVISION AND THAT I AM A REGISTERED PROFESSIONAL ENGINEER IN THE STATES SHOWN



SMART DECK INSULATED FLOORING SYSTEM ALLOWABLE LIVE LOADS

EFFECTIVE DATE: 2-04 LD

| PANEL TYPE | SPAN | RECOMMENDED ALLOWABLE LIVE LOAD | | MAXIMUM ALLOWABLE LIVE LOAD | |
|---|-----------------|---------------------------------|-------------------|-----------------------------|-------------------|
| | | DEFLECTION = L/600 | | DEFLECTION = L/360 | |
| | | PSF | KG/M ² | PSF | KG/M ² |
| 7/16" OSB 5 5/8" EPS (1LB PER CU/FT) 7/16" OSB NOTE: FOR HARD SURFACE FLOORING WE RECOMMEND PLYWOOD, OR WONDERBOARD, BE STAGGERED ON TOP OF OSB SURFACE USING GLUE AND SCREWS USE L/600 DEFLECTION LOAD VALUES | 6 FT [1.83 M] | 203 | 991 | 203 | 991 |
| | 7 FT [2.13 M] | 150 | 776 | 174 | 849 |
| | 8 FT [2.44 M] | 108 | 527 | 152 | 742 |
| | 9 FT [2.74 M] | 76 | 371 | 130 | 635 |
| | 10 FT [3.05 M] | 55 | 269 | 95 | 464 |
| | 11 FT [3.35 M] | 41 | 200 | 71 | 347 |
| | 12 FT [3.66 M] | 31 | 151 | 54 | 264 |
| | 13 FT [3.96 M] | 24 | 117 | 42 | 205 |
| | 14 FT [4.27 M] | 18 | 88 | 33 | 161 |
| | 15 FT [4.57 M] | 14 | 68 | 27 | 132 |
| | 16 FT [4.88 M] | 11 | 54 | 21 | 103 |

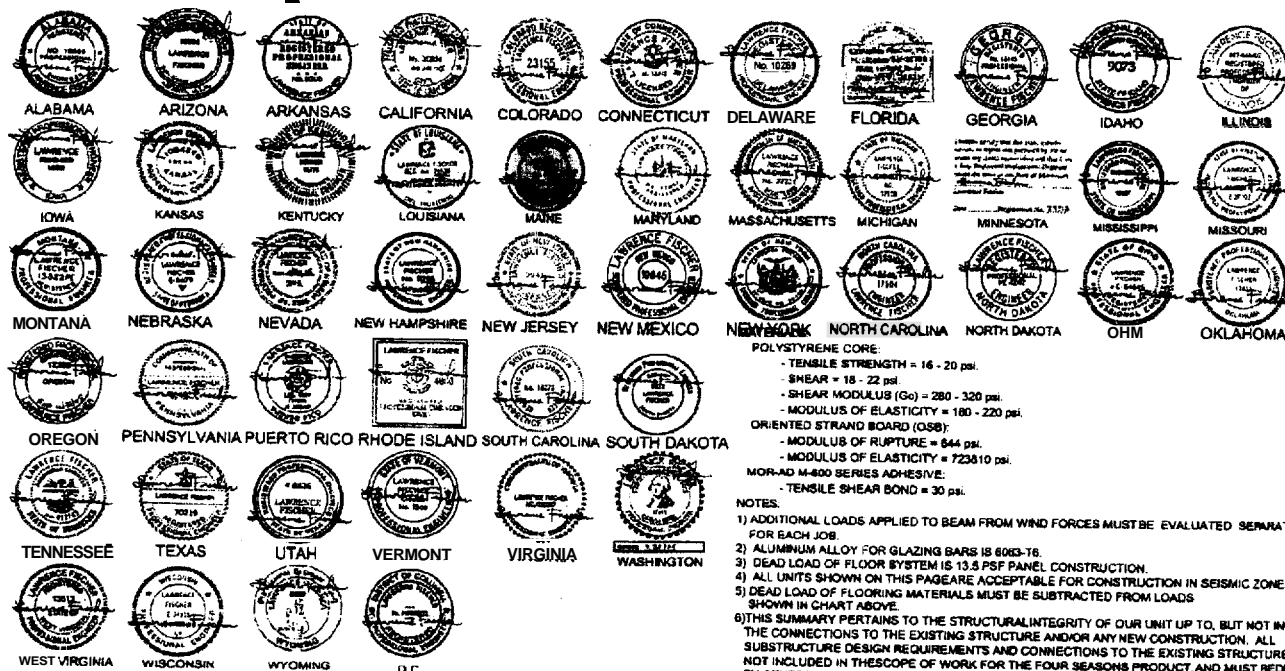
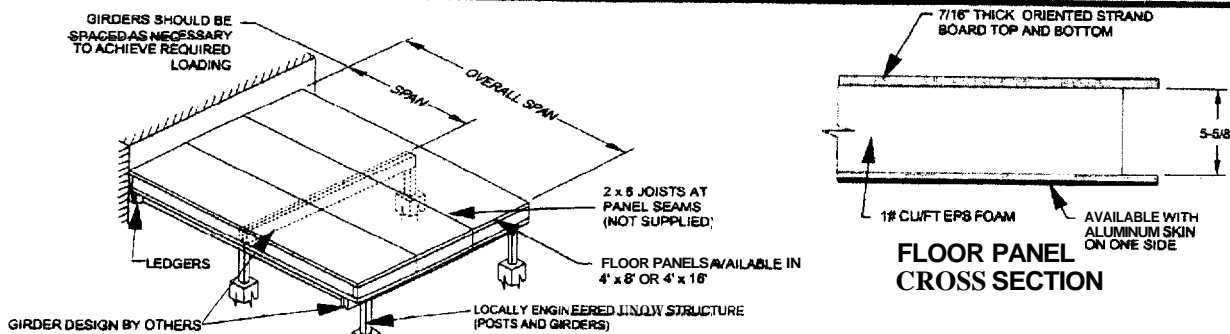

POLYSTYRENE CORE:

- TENSILE STRENGTH = 16 - 20 psi.
- SHEAR = 18 - 22 psi.
- SHEAR MODULUS (G_o) = 280 - 320 psi.
- MODULUS OF ELASTICITY = 180 - 220 psi.

ORIENTED STRAND BOARD (OSB):

- MODULUS OF RUPTURE = 644 psi.
- MODULUS OF ELASTICITY = 723810 psi.

MOR-AD M-800 SERIES ADHESIVE:

- TENSILE SHEAR BOND = 30 psi.

- NOTES:**
- 1) ADDITIONAL LOADS APPLIED TO BEAM FROM WIND FORCES MUST BE EVALUATED SEPARATELY FOR EACH JOB.
 - 2) ALUMINUM ALLOY FOR GLAZING BARS IS 6063-T6.
 - 3) DEAD LOAD OF FLOOR SYSTEM IS 10.5 PSF PANEL CONSTRUCTION.
 - 4) ALL UNITS SHOWN ON THIS PAGE ARE ACCEPTABLE FOR CONSTRUCTION IN SEISMIC ZONE 4.
 - 5) DEAD LOAD OF FLOORING MATERIALS MUST BE SUBTRACTED FROM LOADS SHOWN IN CHART ABOVE.
 - 6) THIS SUMMARY PERTAINS TO THE STRUCTURAL INTEGRITY OF OUR UNIT UP TO, BUT NOT INCLUDING THE CONNECTIONS TO THE EXISTING STRUCTURE AND/OR ANY NEW CONSTRUCTION. ALL SUBSTRUCTURE DESIGN REQUIREMENTS AND CONNECTIONS TO THE EXISTING STRUCTURE ARE NOT INCLUDED IN THE SCOPE OF WORK FOR THE FOUR SEASONS PRODUCT, AND MUST BE DESIGNED BY OTHERS.
 - 7) THE ENGINEERING DESIGN SCOPE FOR THE FOUR SEASONS PRODUCT DOES NOT ACCOUNT OR SPECIAL LOAD CONDITIONS CREATED BY ATTACHMENT TO THE EXISTING STRUCTURE. THESE MAY INCLUDE SNOW DRIFTING OR UNBALANCE SNOW LOADING. ANY SPECIAL LOADING CONDITIONS MUST BE EVALUATED BY OTHERS.
 - 8) ENGINEER'S CERTIFICATION: LAWRENCE FISCHER CERTIFY THAT THESE ENGINEERING SPECIFICATIONS HAVE BEEN PREPARED UNDER MY DIRECT SUPERVISION AND THAT I AM A REGISTERED PROFESSIONAL ENGINEER IN THE STATES SHOWN.



PRECAST CONCRETE PIERS

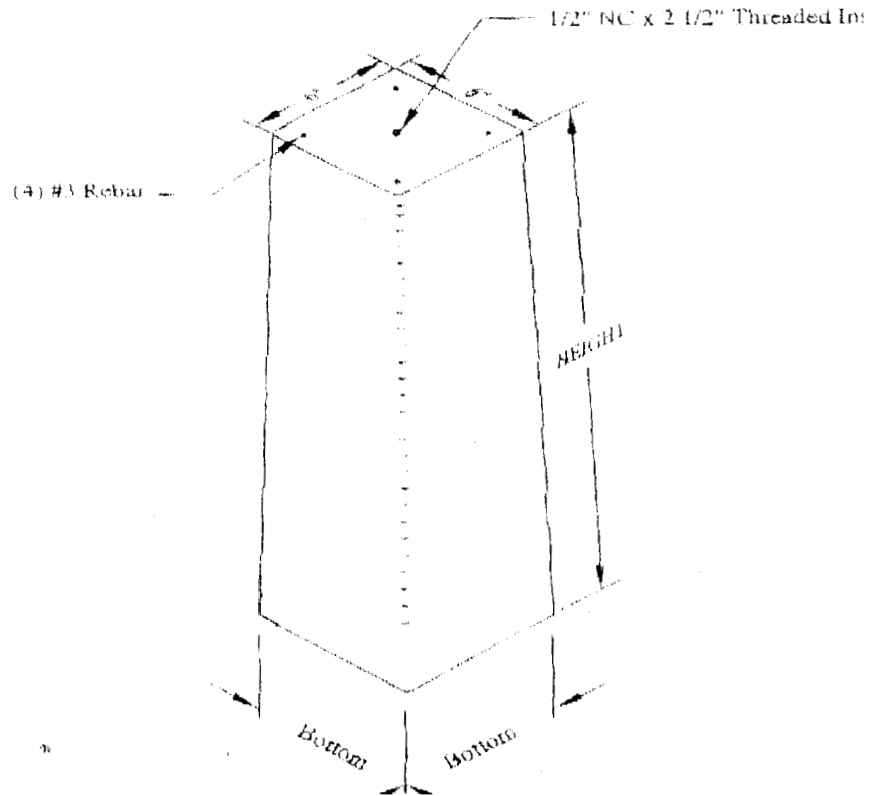

ELEVATION

| Height (Feet) | Bottom (Inches) | Item # | Weight |
|---------------|-----------------|--------|----------|
| 4'-0" | 9" | 21740 | 230 lbs. |
| 5'-0" | 10" | 21750 | 340 lbs. |
| 6'-0" | 11" | 21760 | 450 lbs. |

DESIGN NOTES:

- 1) Concrete Mix Design is 4,000 PSI standard at 28 days, Type 3 Cement
- 2) Reinforcing Steel ASTM A 615, Grade 60
- 2) Smooth Finish on all exposed surfaces

CNA Gagne Firm/Gagne Catalog/Section 1/Precast_Pier.dwg 022003

HARDSCAPE PRODUCTS • CONSTRUCTION SUPPLIES • CONCRETE BLOCKS • PRECAST PRODUCTS

270 Riverside Drive
Auburn, ME 04210
1-800-339-1132

RR 1 Box 85
Belgrade, ME 04917
1-800-339-3313

1506 State Street
Veazie, ME 04401
1-800-649-7393

70 Warren Avenue
Westbrook, ME 04902
1-800-339-9184

www.gagneprecast.com



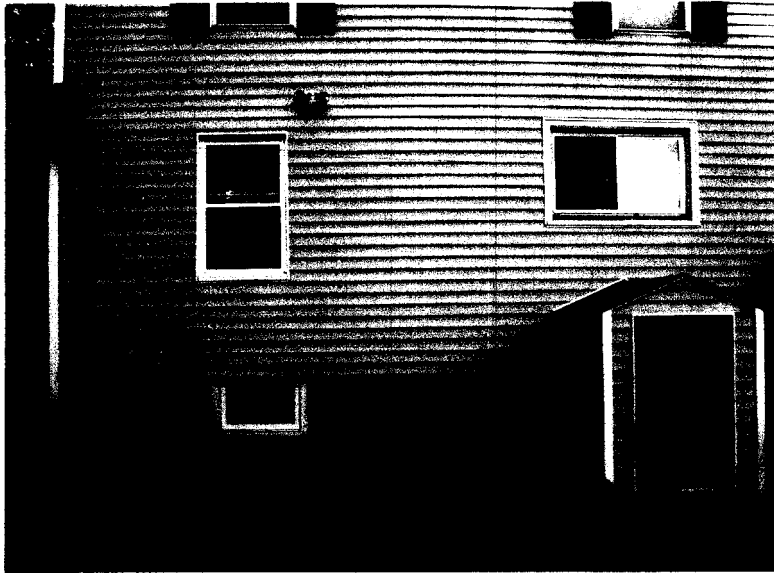

And she does covenant with the said Grantees, their heirs and assigns, that she shall and will warrant and defend the premises to the said Grantees, their heirs and assigns forever, against the lawful claims and demands of all persons claiming by, through, or under them.

WITNESS my hand and seal this 27th day of SEPTEMBER, 1994.

WITNESS

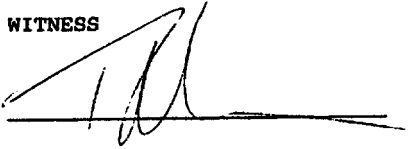

Phyllis V. Washburn
Phyllis V. Washburn

STATE OF MAINE
CUMBERLAND, ss.

SEPTEMBER 20, 1994

Then personally appeared the above-named PHYLLIS V. WASHBURN and acknowledged the foregoing instrument to be her free act and deed.

Before me



Notary Public/Attorney at Law

THOMAS W. LAUTERZ

RECEIVED
SEP 27 1994
94 SEP 30 PM 3:03
CUMBERLAND COUNTY
John B. [unclear]

60456
WARRANTY DEED
(Statutory Short Form)

I, **PHYLLIS V. WASHBURN**, of Portland, County of Cumberland, and State of Maine, for consideration paid, grant to **WILLIAM L. STRAIGHT** and **MELISSA S. STRAIGHT**, both of Portland, County of Cumberland, and State of Maine, as joint tenants and not as tenants in common, their heirs and assigns forever, **WITH WARRANTY COVENANTS**, the following described real estate in Portland, County of Cumberland, and State of Maine:

A certain lot or parcel of land, with the buildings thereon, situated in the City of Portland, County of Cumberland and State of Maine, more particularly described as follows:

ENCLOSURE

A certain lot or parcel of land with the buildings thereon, situated in said Portland, on Belfort Street, being lots numbered **Two Hundred Ninety (290)** and **Two Hundred Ninety-One (291)** as shown on a plan of Portland Villa Sites, made by Ernest W. Branch, C.E., dated July 9, 1912, and recorded in Cumberland County Registry of Deeds, Plan Book 14, Page 7, said lots taken together measure sixty (60) feet on Belfort Street, one hundred ten (110) feet on Wirt Street, sixty (60) feet on lot numbered **Two Hundred Eighty-Nine (289)**, as shown on said plan, one hundred nine and **56/100 (109.56)** feet on lot numbered **Two Hundred Ninety-Two (292)** as shown on said plan; containing, taken together according to said plan, six thousand five hundred eighty-seven (6,587) square feet, more or less.

Together with the fee, insofar as the said Grantor has a right so to convey the same, of all the streets and ways shown on said plan in common with the owners of the other lots shown on said plan, and subject to the right of all the said lot owners to make any customary use of said streets and ways.

Meaning and intending to convey and hereby conveying the same premises conveyed to the Grantor herein by deed from **Phyllis V. Washburn** and **Linda Chase Gauvin**, formerly known as **Linda C. Chase**, dated December 27, 1991, and recorded in the Cumberland County Registry of Deeds in Book 9845, Page 306.

TO HAVE AND TO HOLD the same, together with all the privileges and appurtenances thereunto belonging, to the said **Phyllis V. Washburn**, her heirs and assigns forever.

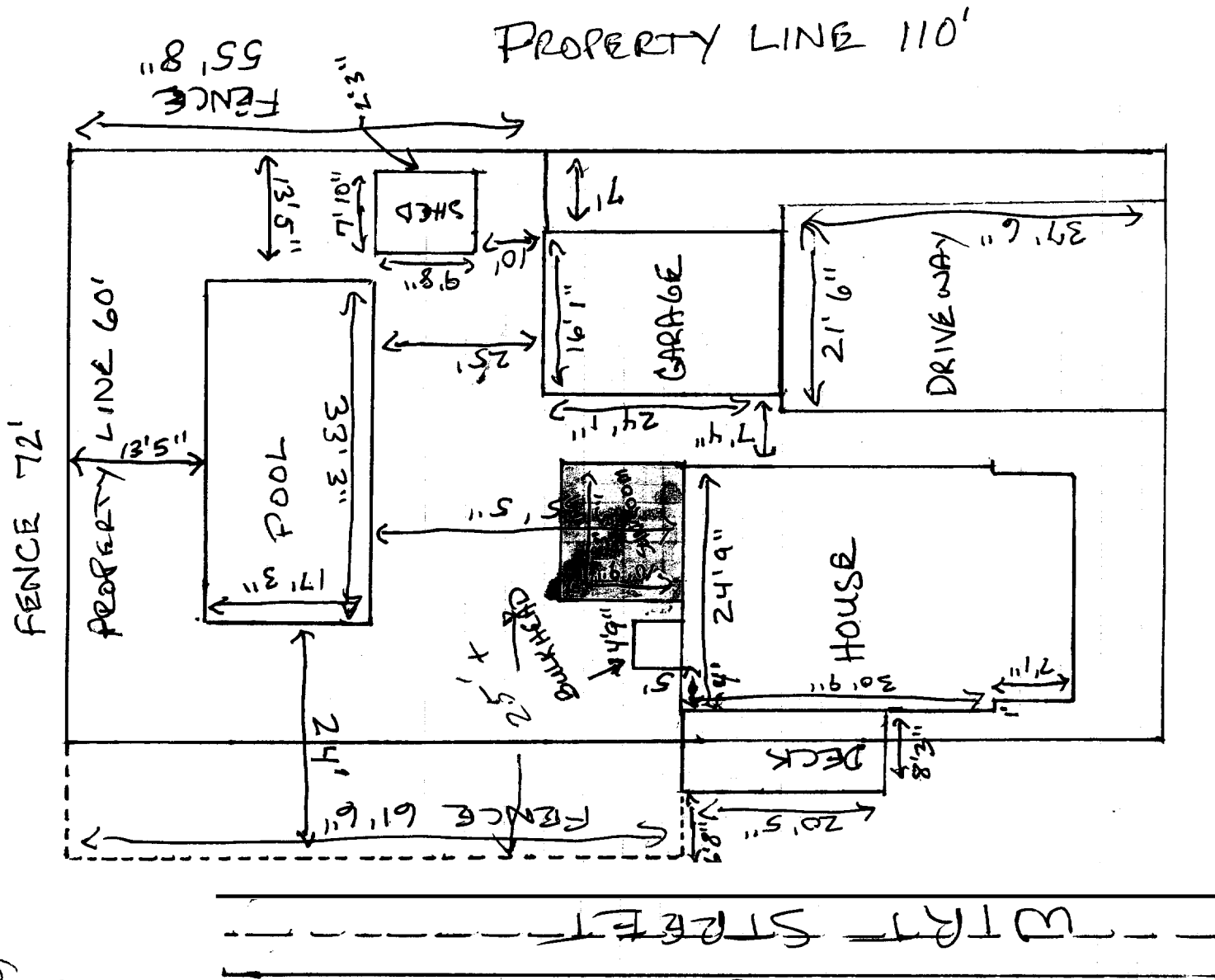

R-5
 Rear 25' side on side street
 Side - 8' 25' side on side street

9/21/05 - Setbacks + pier depth - OK
for sunroom. TM

9/30/05 - Piers OK 48" deep? Power OK - close in wall. (Pum)



CITY OF PORTLAND, MAINE

Department of Building Inspections

7-11 20 05

Received from Melissa Straight

Location of Work 57 Belmont St.

Cost of Construction \$ _____

Permit Fee \$ 363.00

Building (I1) Plumbing (I5) Electrical (I2) Site Plan (U2)

Other _____

CBL: 159 D 21-72

Check #: 1008 Total Collected \$ 363.00

THIS IS NOT A PERMIT

No work is to be started until PERMIT CARD is actually posted upon the premises. Acceptance of fee is no guarantee that permit will be granted. PRESERVE THIS RECEIPT. In case permit cannot be granted the amount of the fee will be refunded upon return of the receipt less \$10.00 or 10% whichever is greater.

WHITE - Applicant's Copy
YELLOW - Office Copy
PINK - Permit Copy