

DISPLAY THIS CARD ON PRINCIPAL FRONTAGE OF WORK



# CITY OF PORTLAND BUILDING PERMIT

This is to certify that MADD LLC

Located At 182 HICKS ST

Job ID: 2011-11-2749-SF

CBL: 296- C-001-001

has permission to Install new gas Heat

provided that the person or persons, firm or corporation accepting this permit shall comply with all of the provisions of the Statues of Maine and of the Ordinances of the City of Portland regulating the construction, maintenance and use of the buildings and structures, and of the application on file in the department.

Notification of inspection and written permission procured before this building or part thereof is lathed or otherwise closed-in. 48 HOUR NOTICE IS REQUIRED.

A final inspection must be completed by owner before this building or part thereof is occupied. If a certificate of occupancy is required, it must be

**Fire Prevention Officer**

**Code Enforcement Officer / Plan Reviewer**

**THIS CARD MUST BE POSTED ON THE STREET SIDE OF THE PROPERTY  
PENALTY FOR REMOVING THIS CARD**

**SCANNED**

## BUILDING PERMIT INSPECTION PROCEDURES

Please call 874-8703 or 874-8693 (ONLY)

or email: [buildinginspections@portlandmaine.gov](mailto:buildinginspections@portlandmaine.gov)

With the issuance of this permit, the owner, builder or their designee is required to provide adequate notice to the city of Portland Inspections Services for the following inspections. Appointments must be requested 48 to 72 hours in advance of the required inspection. The inspection date will need to be confirmed by this office.

- **Please read the conditions of approval that is attached to this permit!! Contact this office if you have any questions.**
- **Permits expire in 6 months. If the project is not started or ceases for 6 months.**
- **If the inspection requirements are not followed as stated below additional fees may be incurred due to the issuance of a "Stop Work Order" and subsequent release to continue.**



The project cannot move to the next phase prior to the required inspection and approval to continue, REGARDLESS OF THE NOTICE OF CIRCUMSTANCES.

IF THE PERMIT REQUIRES A CERTIFICATE OF OCCUPANCY, IT MUST BE PAID FOR AND ISSUED TO THE OWNER OR DESIGNEE BEFORE THE SPACE MAY BE OCCUPIED.

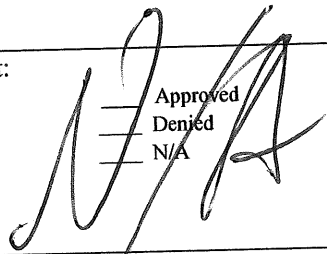
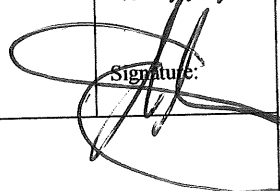
**City of Portland, Maine - Building or Use Permit Application**  
 389 Congress Street, 04101 Tel: (207) 874-8703, FAX: (207) 8716

Job No: 2011-11-2749-SF 2012-44767 HVAC	Date Applied: 6/08/2012	CBL: 296- C-001-001	
Location of Construction: 182 HICKS ST	Owner Name: MADD LLC	Owner Address: 453 ALLEN AVENUE, PORTLAND, ME 04103	Phone:
Business Name:	Contractor Name: Robert S. Dorr	Contractor Address: 17 MILLIKEN RD., SCARBOROUGH, ME 04074	Phone: (207) 415-3375
Lessee/Buyer's Name:	Phone:	Permit Type: HVAC	Zone: R-3
Past Use:  Single family dwelling under construction	Proposed Use:  Same: Single family dwelling - to install new heating system	Cost of Work: \$6,000.00	CEO District:
		Fire Dept:  Approved Denied N/A	Inspection: Use Group: P-3 Type: HVAC
		Signature: 	Signature: 
Proposed Project Description: HVAC system		Pedestrian Activities District (P.A.D.)	
Permit Taken By: Brad		<b>Zoning Approval</b>	

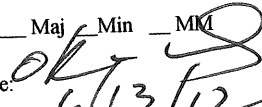
- This permit application does not preclude the Applicant(s) from meeting applicable State and Federal Rules.
- Building Permits do not include plumbing, septic or electrical work.
- Building permits are void if work is not started within six (6) months of the date of issuance. False informatin may invalidate a building permit and stop all work.

Special Zone or Reviews	Zoning Appeal	Historic Preservation
<input type="checkbox"/> Shoreland <input type="checkbox"/> Wetlands <input type="checkbox"/> Flood Zone <input type="checkbox"/> Subdivision <input type="checkbox"/> Site Plan  <input type="checkbox"/> Maj <input type="checkbox"/> Min <input type="checkbox"/> MM Date:  6/13/12	<input type="checkbox"/> Variance <input type="checkbox"/> Miscellaneous <input type="checkbox"/> Conditional Use <input type="checkbox"/> Interpretation <input type="checkbox"/> Approved <input type="checkbox"/> Denied  Date:	<input checked="" type="checkbox"/> Not in Dist or Landmark <input type="checkbox"/> Does not Require Review <input type="checkbox"/> Requires Review <input type="checkbox"/> Approved <input type="checkbox"/> Approved w/Conditions <input type="checkbox"/> Denied  Date: 

**CERTIFICATION**

I hereby certify that I am the owner of record of the named property, or that the proposed work is authorized by the owner of record and that I have been authorized by the owner to make this application as his authorized agent and I agree to conform to all applicable laws of this jurisdiction. In addition, if a permit for work described in the appication is issued, I certify that the code official's authorized representative shall have the authority to enter all areas covered by such permit at any reasonable hour to enforce the provision of the code(s) applicable to such permit.

SIGNATURE OF APPLICANT	ADDRESS	DATE	PHONE
RESPONSIBLE PERSON IN CHARGE OF WORK, TITLE		DATE	PHONE



FILL IN AND SIGN WITH INK

# APPLICATION FOR PERMIT HEATING OR POWER EQUIPMENT

Entered  
6/8/12  
(B3)

To the INSPECTOR OF BUILDINGS, PORTLAND, ME.

The undersigned hereby applies for a permit to install the following heating, cooking or power equipment in accordance with the Laws of Maine, the Building Code of the City of Portland, and the following specifications:

Location / CBL 182 Hick St. (Front Home) Use of Building Residential Date 6/8/12

Name and address of owner of appliance MADD LLC 296-C-DOT LEAD  
453 Allen Ave

Installer's name and address Robert S Dorn 417 Milliken Rd.  
Scarborough Me. 04074 Telephone 415-3375

**Location of appliance:**  
 Basement       Floor  
 Attic             Roof

**Type of Fuel:**  
 Gas             Oil

**Appliance Name:** \_\_\_\_\_  
 U.L. Approved  Yes  No

Will appliance be installed in accordance with the manufacture's installation instructions?  Yes  No

IF NO Explain: \_\_\_\_\_

RECEIVED  
JUN 08 2012  
Dept. of Building Inspections  
City of Portland Maine

**Type of Chimney:**  
 Masonry Lined  
 Factory built YES

Metal  
 Factory Built U.L. Listing # \_\_\_\_\_

Direct Vent  
 Type PVC UL# \_\_\_\_\_

**Type of Fuel Tank**  
 Oil  
 Gas

Size of Tank N/A

Number of Tanks N/A

Distance from Tank to Center of Flame \_\_\_\_\_ feet.

Cost of Work: 6000  
\$ 5500.00

Permit Fee: \$ 80.00

**The Type of License of Installer:**

Master Plumber # \_\_\_\_\_  
 Solid Fuel # \_\_\_\_\_  
 Oil # \_\_\_\_\_  
 Gas # PNT 3597  
 Other \_\_\_\_\_

**Approved**

Fire: \_\_\_\_\_  
 Ele.: \_\_\_\_\_  
 Bldg.: \_\_\_\_\_

Signature of Installer Robert S Dorn

**Approved with Conditions**

See attached letter or requirement

Inspector's Signature \_\_\_\_\_ Date Approved \_\_\_\_\_



# PORTLAND MAINE

*Strengthening a Remarkable City, Building a Community for Life • www.portlandmaine.gov*

Receipts Details:

**Tender Information:** Check , Check Number: 7211  
**Tender Amount:** 80.00

Receipt Header:

**Cashier Id:** bsaucier  
**Receipt Date:** 6/8/2012  
**Receipt Number:** 44768

Receipt Details:

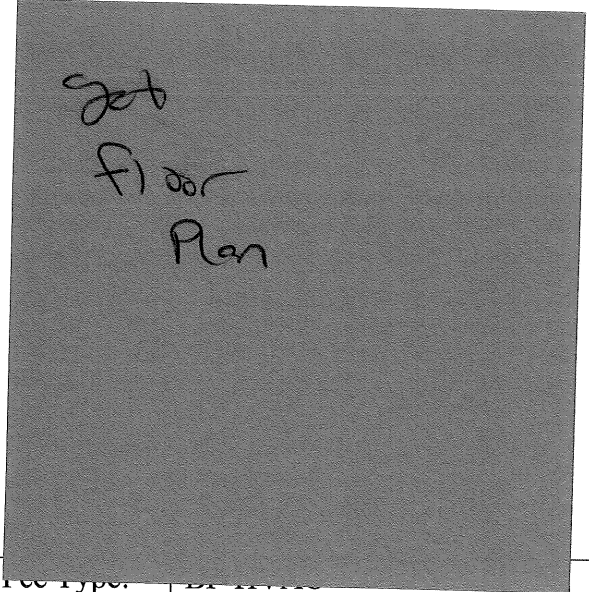

Referance ID:	6822	Fee Type:	DR
Receipt Number:	0	Payment Date:	
Transaction Amount:	80.00	Charge Amount:	80.00
Job ID: Job ID: 2011-11-2749-SF - 1456 sq ft colonial - 28' x 26'-no gar UI#091258			
Additional Comments: 182 Hicks			

Thank You for your Payment!

NOW WITH 100%  
CUSTOMER SATISFACTION  
GUARANTEE

182 Hicks

# LAARS<sup>®</sup> MASCOT<sup>®</sup> II

Gas-Fired Wall-Mounted  
Combination Boiler &  
Water Heater

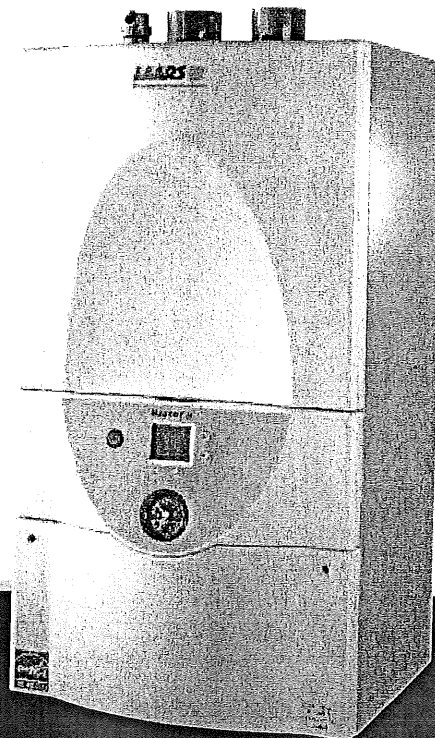

**LAARS<sup>®</sup>**   
Heating Systems Company  
A subsidiary of BRADFORD WHITE<sup>®</sup> Corporation

# High Efficiency Mascot® II Boilers

The Mascot II is a 125 MBTU heating only or combination ("Combi" - heating and domestic hot water) wall mounted boiler packed with features and benefits that both the homeowner and contractor can enjoy.

For the homeowner, the Mascot II offers a 95% plus efficiency rating for lower operating costs, has "zero clearance installation" so it can fit just about anywhere and has a modern appliance design. It is a reliable, quiet, smooth operating boiler that has enough output to keep your home warm with continuous hot water for long relaxing showers.

Contractors will love the Mascot II because they install in less time than other units do, thanks to the service-friendly design and full package of system components. Components are easily accessible for disassembly, should an unlikely call for service be required, saving service time and money.

Boiler setup is a breeze because of full access to both the gas valve and control panel at the same time (see figure on following page). The gas valve is accessible directly behind the front lower panel that rotates down via a hinged connection. While the lower panel is open, the center console that houses the control display remains closed and fully visible.

- Sleek, appliance-grade cabinet that looks great in any location
- 95% AFUE efficiency, condensing operation
- 2-year parts warranty, 12-year heat exchanger warranty
- Energy Star qualified
- Zero Installation Clearance
- Sealed combustion
- Direct spark ignition for smooth reliable starts
- Two venting options to meet the needs of almost any installation
- Optimized gas usage for lower energy bills via 20% to 100% input modulating gas valve
- Quiet variable speed blower
- Boilers are set up for natural gas, no parts necessary for conversion to LP gas
- Built in expansion tank that will handle 26 gallons of system water (enough to cover 1,800 feet of ½" PEX tubing)
- Three speed circulator with air vent and "quick-remove" mounting system
- Automatic 3-way valve for DHW priority eliminates the need for separate zone setup when using an indirect DHW tank
- Mounting kit with template and wall bracket for fast and easy installation
- Light-weight (100 lbs.) makes handling easy
- Stainless steel A.S.M.E. primary heat exchanger with externally welded manifolds for better flow rates and prevention of leaks
- Stainless steel brazed plate DHW heat exchanger (combi models) with advanced flow switch
- Hydronic system water pressure sensor for safety at low water levels
- Advanced Laars integrated control system with temperature control, diagnostics, outdoor reset capability, and easy access for field wiring
- Unique, sealed condensate trap does not need to be primed at startup
- Pump Freeze Protection

**LAARS**   
Heating Systems Company  
A subsidiary of BRADFORD WHITE Corporation

# MASCOT® II

## INTELLIGENTLY DESIGNED

Air elimination valve



Concentric or two-pipe venting connections, two-pipe connection uses standard off the shelf PVC or CPVC piping.

A built in expansion tank eliminates unsightly externally mounted tanks

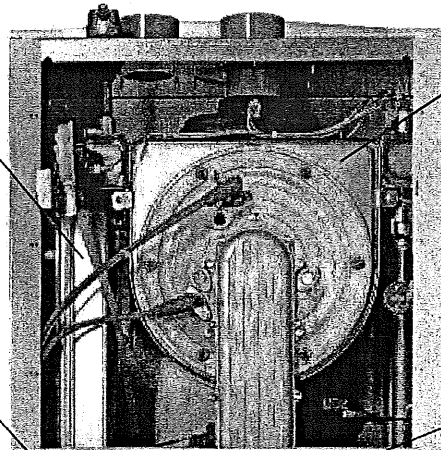

Each Mascot II uses a state of the art, condensing, stainless steel heat exchanger with a 5:1 turndown. The design delivers 95% AFUE, a low 10ppm NOx emissions and only 1.5 amp electrical draw resulting in one of the most environmentally friendly, compact, combination units on the market.

System is fully protected with resettable circuit breakers

Every Mascot II is equipped with an advanced Laars integrated LCD push button control system, illuminated power switch and pressure gauge. Temperature control, diagnostics, outdoor reset capability and many other functions are seamlessly integrated in this one easy to use center console.

Each Mascot II is supplied with a unique, sealed condensate trap that does not need priming at startup.

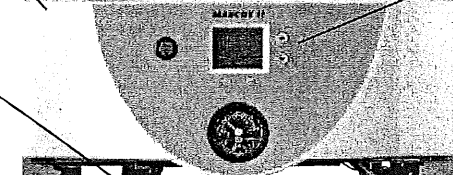

The Mascot II lower door opens independently from the rest of the unit allowing access to both the gas valve and controls at the same time, making setup very easy.

Laars advanced integrated control system

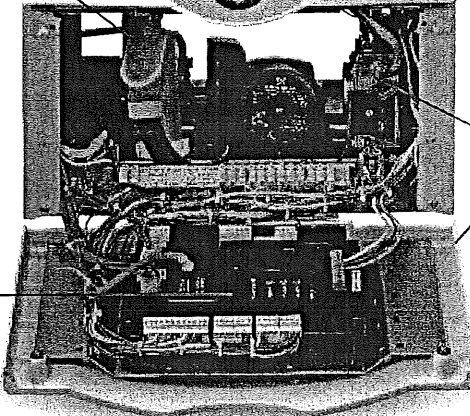

Mascot II boilers are designed with a built-in expansion tank, air elimination vent, three-speed circulator, primeless condensate trap and direct access to wiring. These features, along with a wall-mounting template, save contractors hundreds of dollars in material & labor and help reduce installation errors. Not to mention most components are "off the shelf" replacement parts and can easily be obtained from many distribution locations.



# LAARS® MASCOT® II DIMENSIONS

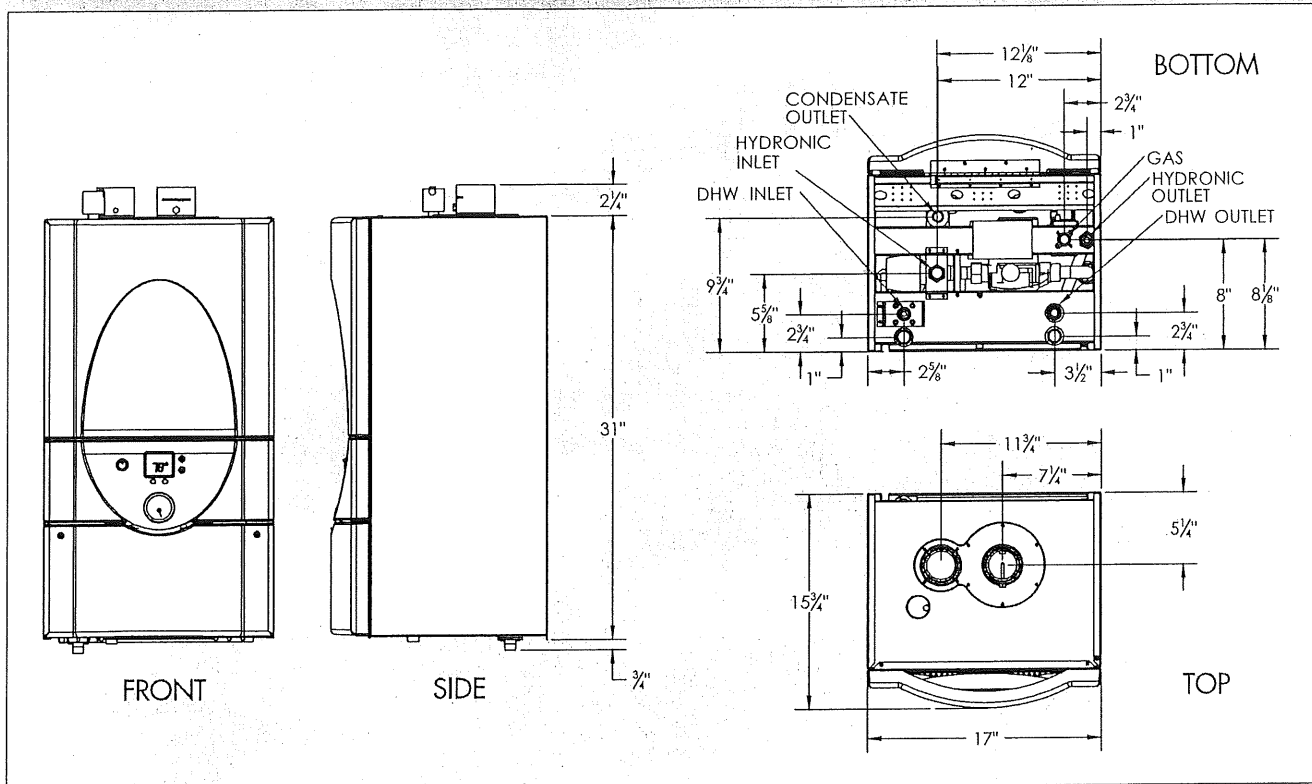

# LAARS® MASCOT® II SPECIFICATIONS

DESCRIPTION	MASCOT II - 125	
Fuel	Natural Gas / LP Gas	
Input, max fire	125,000 BTU/hr	36.6 kW
Output, max fire	121,250 BTU/hr	35.5 kW
DHW Max Outlet Water Temp	180 °F	60 °C
DHW Max Flow Rate (di@60°F)	4.0 gpm	15.1 l/m
Flow Rate, min	0.5 gpm	1.9 l/m
Pressure Relief Setting	30 psi	207 kPa
Gas Connection	1/2	NPT
Supply Flow Connection	3/4	NPT
Return Flow Connection	3/4	NPT
Burner and Heat Exchanger Material	Stainless Steel	—
Weight	100 lbs	45.4 kg
<b>Service Clearances</b>		
Front and Bottom	24 in	61 cm
Top and Sides	6 in	15.2 cm
<b>Air Vents</b>		
Two Pipe Flue Terminal	2 in	5.1 cm
Concentric	3 / 5 in	7.6 / 12.7 cm
<b>Electrical Supply</b>		
Voltage	120 V	
Frequency	60 HZ	

## THE MASCOT® II

- Operates quietly, smoothly and reliably
- Energy Star rated, 95% Efficient (AFUE)
- Low emissions, 10ppm NOx
- Zero installation clearance, fits almost anywhere
- Easy to install, setup and service
- 2 year parts, 12 year heat exchanger warranty



## 100% CUSTOMER SATISFACTION GUARANTEE

If your Mascot II requires more than two warranty service repairs during the first year of operation, we will replace the boiler at no charge!

This program rivals any in the industry. All you have to do is have the boiler installed and started up per the installation & operations manual and register with Laars via a 10-Point installation checklist. It's that simple, Laars is engineered to be the best.

*Ask your local Laars representative for details.*

## MASCOT® II APPLICATIONS

- Perfect for radiant floor heating applications, and systems with large emitters - no restriction on low return water temperatures
- Approved for closet and alcove installations – perfect for condominiums and town homes
- Great for saving space by combining heating and domestic hot water in one small appliance

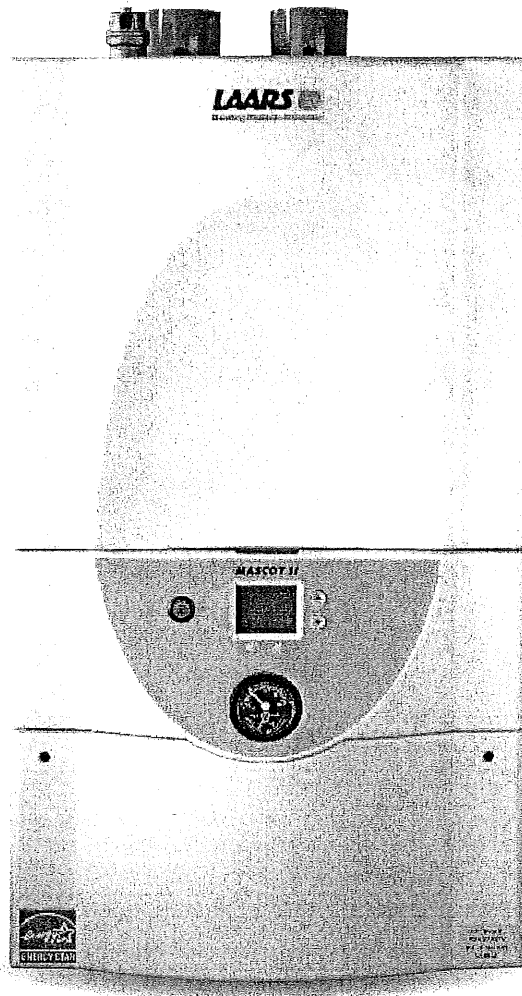

**American design, with clean  
appliance look and feel**

**LAARS®**

Heating Systems Company  
A subsidiary of BRADFORD WHITE® Corporation

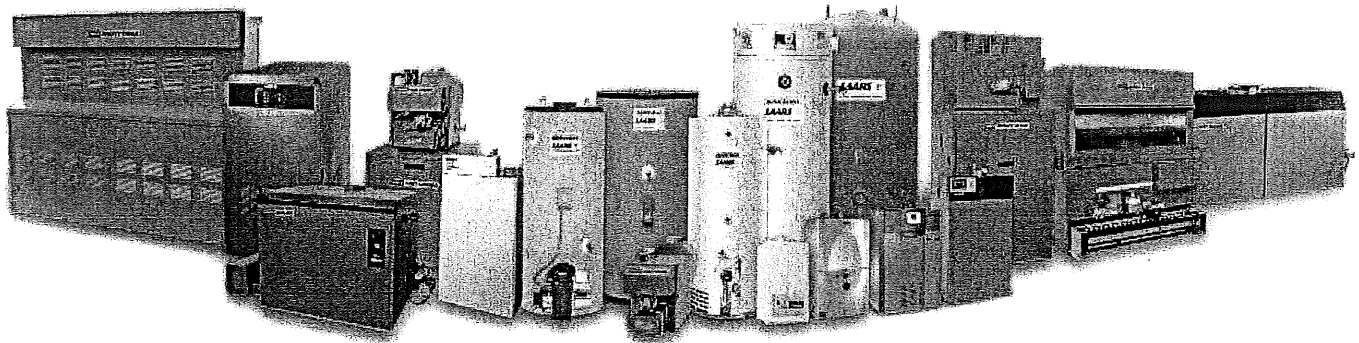

View our entire product line at [www.Laars.com](http://www.Laars.com)



**LAARS**<sup>®</sup>   
**Heating Systems Company**  
 A subsidiary of **BRADFORD WHITE** Corporation

800.900.9276 • Fax 800.559.1583 (Customer Service, Service Advisors)  
 20 Industrial Way, Rochester, NH 03867 • 603.335.6300 • Fax 603.335.3355 (Applications Engineering)  
 1869 Sismet Road, Mississauga, Ontario, Canada L4W 1W8 • 905.238.0100 • Fax 905.366.0130

[www.Laars.com](http://www.Laars.com)

Litho in U.S.A.

© Laars<sup>®</sup> Heating Systems Co. 1108 Document 1234A

# DISPLAY THIS CARD ON PRINCIPAL FRONTAGE OF WORK CITY OF PORTLAND

Please Read Application And Notes, If Any, Attached

## BUILDING PERMIT

Permit Number: 091258

This is to certify that Madd LLC/Len Anderson

has permission to Build new 1456 square foot colonial home with no garage.

AT 182 Hicks St CP 296 C001001

provided that the person or persons, firm or corporation accepting this permit shall comply with all of the provisions of the Statutes of Maine and of the Ordinances of the City of Portland regulating the construction, maintenance and use of buildings and structures, and of the application on file in this department.

Apply to Public Works for street line and grade if nature of work requires such information.

Notification of inspection must be given and written permission procured before this building or part thereof is lath or other work is set-in. 24 HOUR NOTICE IS REQUIRED.

A certificate of occupancy must be procured by owner before this building or part thereof is occupied.

### OTHER REQUIRED APPROVALS

Fire Dept. \_\_\_\_\_

Health Dept. \_\_\_\_\_

Appeal Board \_\_\_\_\_

Other \_\_\_\_\_

Department Name

Director - Building & Inspection Services

**PENALTY FOR REMOVING THIS CARD**