

DISPLAY THIS CARD ON PRINCIPAL FRONTAGE OF WORK
CITY OF PORTLAND

Please Read
Application And
Notes, If Any,
Attached

PERMIT

Permit Number: 030087

This is to certify that 1140 Brighton Avenue / P.M. Construction

has permission to Change of use from restaurant to retail, with tenant's shop.

AT 1140 Brighton Ave 265 B004001

provided that the person or persons, firm or corporation accepting this permit shall comply with all of the provisions of the Statutes of this State and of the Ordinances of the City of Portland regulating the construction, maintenance and use of buildings and structures, and of the application on file in this department.

Apply to Public Works for street line and grade if nature of work requires such information.

Notification of inspection must be given and when permission is procured before this building or part thereof is altered or enclosed-in. 24 HOUR NOTICE IS REQUIRED.

A certificate of occupancy must be procured by owner before this building or part thereof is occupied.

OTHER REQUIRED APPROVALS

Fire Dept. [Signature]
Health Dept. _____
Appeal Board _____
Other _____
Department Name

[Signature] 3/20/03
Director - Building & Inspection Services

PENALTY FOR REMOVING THIS CARD

City of Portland, Maine - Building or Use Permit Application

389 Congress Street, 04101 Tel: (207) 874-8703, Fax: (207) 874-8716

Permit No: 03-0087	Issue Date:	CBL: 265 B004001
-----------------------	-------------	---------------------

Location of Construction: 1140 Brighton Ave	Owner Name: 1140 Brighton Avenue	Owner Address: 738 Bark St	Phone:
Business Name: n/a	Contractor Name: P.M. Constuction	Contractor Address: 19 Industrial Park Road Saco	Phone: 2072827697
Lessee/Buyer's Name n/a	Phone: n/a	Permit Type: Alterations - Commercial	Zone: B-2

Past Use: Commercial / Prior Use Restaurant	Proposed Use: Commercial / Change of Use; from restaurant to Aarons Furniture, retail. Tenant fit up is included.	Permit Fee: \$1,498.00	Cost of Work: \$200,000.00	CEO District: 3
		FIRE DEPT: <input checked="" type="checkbox"/> Approved <input type="checkbox"/> Denied	INSPECTION: Use Group: M Type: 2 3/20/03	

Proposed Project Description:
Change of use from restaurant to retail, with tenant fit up. - over 5,000 sq ft requires site plan
Signature: *[Handwritten Signature]*

PEDESTRIAN ACTIVITIES DISTRICT (P.A.D.)		
Action:	<input type="checkbox"/> Approved	<input type="checkbox"/> Approved w/Conditions
Signature:	Date:	

Permit Taken By: gg	Date Applied For: 02/05/2003	Zoning Approval	
------------------------	---------------------------------	------------------------	--

<ol style="list-style-type: none"> This permit application does not preclude the Applicant(s) from meeting applicable State and Federal Rules. Building permits do not include plumbing, septic or electrical work. Building permits are void if work is not started within six (6) months of the date of issuance. False information may invalidate a building permit and stop all work.. 	Special Zone or Reviews <input type="checkbox"/> Shoreland <input type="checkbox"/> Wetland <input type="checkbox"/> Flood Zone <input checked="" type="checkbox"/> Subdivision <input type="checkbox"/> Site Plan Maj <input type="checkbox"/> Minor <input type="checkbox"/> MM <input checked="" type="checkbox"/> S Date: <i>02/20/03</i>	Zoning Appeal <input type="checkbox"/> Variance <input type="checkbox"/> Miscellaneous <input type="checkbox"/> Conditional Use <input type="checkbox"/> Interpretation <input type="checkbox"/> Approved <input type="checkbox"/> Denied Date:	Historic Preservation <input checked="" type="checkbox"/> Not In District or Landmark <input type="checkbox"/> Does Not Require Review <input type="checkbox"/> Requires Review <input type="checkbox"/> Approved <input type="checkbox"/> Approved w/Conditions <input type="checkbox"/> Denied Date:
	<i>Separate permits required for site plan</i> <i>see exemption by State</i>		

CERTIFICATION

I hereby certify that I am the owner of record of the named property, or that the proposed work is authorized by the owner of record and that I have been authorized by the owner to make this application as his authorized agent and I agree to conform to all applicable laws of this jurisdiction. In addition, if a permit for work described in the application is issued, I certify that the code official's authorized representative shall have the authority to enter all areas covered by such permit at any reasonable hour to enforce the provision of the code(s) applicable to such permit.

SIGNATURE OF APPLICANT	ADDRESS	DATE	PHONE
RESPONSIBLE PERSON IN CHARGE OF WORK, TITLE		DATE	PHONE

City of Portland, Maine - Building or Use Permit

389 Congress Street, 04101 Tel: (207) 874-8703, Fax: (207) 874-8716

Permit No: 03-0087	Date Applied For: 02/05/2003	CBL: 265 B004001
------------------------------	--	----------------------------

Location of Construction: 1140 Brighton Ave	Owner Name: 1140 Brighton Avenue	Owner Address: 738 Bark St	Phone:
Business Name: n/a	Contractor Name: P.M. Constuction	Contractor Address: 19 Industrial Park Road Saco	Phone (207) 282-7697
Lessee/Buyer's Name n/a	Phone: n/a	Permit Type: Alterations - Commercial	

Proposed Use: Commercial / Change of Use; from restaurant to Aarons Furniture, retail. Tenant fit up is included. - over 5,000 sq. Ft	Proposed Project Description: Change of use from restaurant to retail, with tenant fit up.
---	--

Dept: Zoning **Status:** Approved with Conditions **Reviewer:** Marge Schmuckal **Approval Date:** 02/28/2003
Note: 2/7/03 I spoke with John Bisetti - this is over 5,000 sq. Ft of ch of use & requires a site plan review or an exemption first **Ok to Issue:**
2/27/03 received a site plan exemption from planning

- 1) Separate permits shall be required for any new signage. _ PLEASE NOTE THAT SIGNAGE IS LIMITED. THERE MAY BE SOME NONCONFORMING SIGNAGE ON SITE THAT CAN NOT BE REUSED.
- 2) This permit is being approved on the basis of plans submitted. Any deviations shall require a separate approval before starting that work.

Dept: Building **Status:** Approved with Conditions **Reviewer:** Mike Nugent **Approval Date:** 03/20/2003
Note: **Ok to Issue:**
1) Basement for storage only, no customer access.
Section 313..1.1of the 1999 BOCA Code allows for the use groups (A-3 and M) to be nonseparated .

Dept: Fire **Status:** Approved **Reviewer:** Lt. McDougall **Approval Date:**
Note: **Ok to Issue:**

Comments:
02/27/2003-kwd: Site plan review exemption received. Sent to Zoning again.
03/10/2003-mjn: Plans need to be stamped, contractor notified

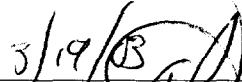
RECEIVED 3/19/03 

All Purpose Building Permit Application

If you or the property owner owes real estate or personal property taxes or user charges on any property within the City, payment arrangements must be made before permits of any kind are accepted.

Location/Address of Construction: <u>1140 Brighton Ave</u>		
Total Square Footage of Proposed Structure	Square Footage of Lot	
Tax Assessor's Chart, Block & Lot Chart# <u>265</u> Block# <u>B</u> Lot# <u>004</u>	Owner: <u>Aaron's Atlanta Georgia</u>	Telephone: <u>678-402-3000</u>
Lessee/Buyer's Name (If Applicable)	Applicant name, address & telephone: <u>PM Construction</u>	Cost Of Work: <u>\$2,200,000 -</u> Fee: <u>\$1,423.00</u>
Current use: _____		
If the location is currently vacant, what was prior use: <u>Valley</u> will either email or bring in reduced plans		
Approximately how long has it been vacant: <u>1 year</u>		
Proposed use: <u>Aaron's Furniture Retail</u>		
Project description: <u>Tenant Fit-up Change of Use</u>		
Contractor's name, address & telephone: <u>PM Construction 19 Industrial Park Road Suite ME 04074</u>		
Who should we contact when the permit is ready: <u>John Bisst. 282-7697</u>		
Mailing address:		
We will contact you by phone when the permit is ready. You must come in and pick up the permit and review the requirements before starting any work, with a Plan Reviewer. A stop work order will be issued and a \$100.00 fee if any work starts before the permit is picked up. PHONE:		

IF THE REQUIRED INFORMATION IS NOT INCLUDED IN THE SUBMISSIONS THE PERMIT WILL BE AUTOMATICALLY DENIED AT THE DISCRETION OF THE BUILDING/PLANNING DEPARTMENT, WE MAY REQUIRE ADDITIONAL INFORMATION IN ORDER TO APPROVE THIS PERMIT.

I hereby certify that I am the Owner of record of the named property, or that the owner of record authorizes the proposed work and that I have been authorized by the owner to make this application as his/her authorized agent. I agree to conform to all applicable laws of this jurisdiction. In addition, if a permit for work described in this application is issued, I certify that the Code Official's authorized representative shall have the authority to enter all areas covered by this permit at any reasonable hour to enforce the provisions of the codes applicable to this permit.

Signature of applicant: <u>John Bisst</u>	Date: <u>2-4-03</u>
---	---------------------

This is NOT a permit, you may not commence ANY work until the permit is issued.
If you are in a Historic District you may be subject to additional permitting and fees with the Planning Department on the 4th floor of City Hall **FEB 5 2003**

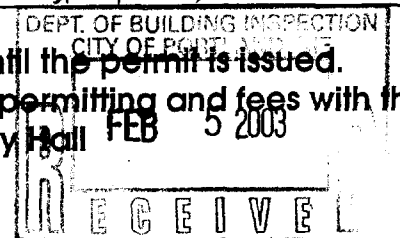

DEPARTMENT DIRECTOR
Lee D. Urban



DIVISION DIRECTORS
Mark B. Adelson
Housing & Neighborhood Services

Alexander Q. Jaegerman
Planning

John N. Lufkin
Economic Development

DEPARTMENT OF PLANNING AND DEVELOPMENT
STOP WORK ORDER

February 14, 2003

John Bisesti
P & M Construction
19 Industrial Park Rd.
Saco, ME 04072

Re: 1140 Brighton Ave., (265 B004)

Hand Delivery

Dear John Bisesti:

An evaluation of the property at 1140 Brighton Ave. revealed that construction activity contemplated by permit application number 030087 has commenced. Because this permit has not been issued, it is a violation of Section 107.1 of the 1999 BOCA Building Code of the City of Portland. You are building without a permit.

This is a **STOP WORK ORDER** pursuant to Section 117.1 of the 1999 BOCA Building Code. All construction activity at the above referenced property must **STOP** immediately.

Construction may begin after your building permit application has been issued and this order has been lifted.

Failure to comply will result in this office referring the matter to the City of Portland Corporation Counsel for legal action and possible civil penalties, as provided for in Section 1-15 of the Code and in Title 30-A M.R.S.A. Ss 4452. This constitutes an appealable decision pursuant to Section 1-16. (2) Of the City of Portland Code of Ordinances. Please feel free to contact me at 874-8693, if you wish to discuss the matter or have any questions.

Sincerely,

Arthur Rowe
Code Enforcement Officer



CITY OF PORTLAND MAINE

389 Congress St., Rm 315

Portland, ME 04101

Tel. - 207-874-8704

Fax - 207-874-8716

TO: Inspector of Buildings City of Portland, Maine
Planning & Urban Development
Division of Housing & Community Services

FROM DESIGNER: MARK SENBELMANN
PORT CITY DESIGN

DATE: 3.18.03

Job Name: AARON'S FURNITURE

Address of Construction: 1140 BRIGHTON AVE PORTLAND

THE BOCA NATIONAL BUILDING CODE/1999 Fourteenth EDITION
Construction project was designed according to the building code criteria listed below:

Building Code and Year BOCA 1999 Use, Group Classification(s) M

Type of Construction 2C Bldg. Height 20' Bldg. Sq. Footage 6500 SF (Tenant Fit-up)

Seismic Zone NA Group Class _____

Roof Snow Load Per Sq. Ft. NA, EXISTING Dead Load Per Sq. Ft. NA

Basic Wind Speed (mph) NA Effective Velocity Pressure Per Sq. Ft. NA

Floor Live Load Per Sq. Ft. NA SLAB ON GRADE

Structure has full sprinkler system? Yes X No _____ Alarm System? Yes _____ No X
Sprinkler & Alarm systems must be installed according to BOCA and NFPA Standards with approval from the Portland Fire Department.

Is structure being considered unlimited area building: Yes _____ No X

If mixed use, what subsection of 313 is being considered 313.1.2 EXCEPTION SPRINKLER

List Occupant loading for each room or space, designed into this Project. 1/100 = 65 OCCUPANTS

PSH 6/07/2K

(Designers Stamp)

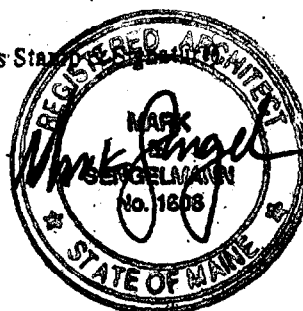



CITY OF PORTLAND
ACCESSIBILITY CERTIFICATE

Designer: MARK SENNELMANN FORT CITY DESIGN

Address of Project 1140 BRIGHTON AVE, PORTLAND

Nature of Project RETAIL / AARON'S FURNITURE
TENANT FIT-UP

Date 3.18.03

The technical submissions covering the proposed construction work as described above have been designed in compliance with applicable referenced standards found in the Maine Human Rights Law and Federal Americans with Disability Act.

(SEAL)

Signature *Mark Sengelmann*

Title PRINCIPAL

Firm FORT CITY DESIGN

Address 43 DEERING ST
PORTLAND ME 04101

Telephone 761-9500

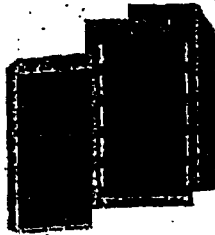

CITY OF PORTLAND
BUILDING CODE CERTIFICATE
389 Congress St., Rm 315
Portland, ME 04101

TO: Inspector of Buildings City of Portland, Maine
Department of Planning & Urban Development
Division of Housing & Community Service

FROM: MARK SENNELMANN
PORT CITY DESIGN

RE: Certificate of Design

DATE: 3.18.03

These plans and/or specifications covering construction work on:

1140 BRIGHTON AVE

AARON'S FURNITURE / RETAIL FIT-UP

Have been designed and drawn up by the undersigned, a Maine registered architect/engineer according to the BOCA National Building Code/1999 Fourteenth Edition, and local amendments.

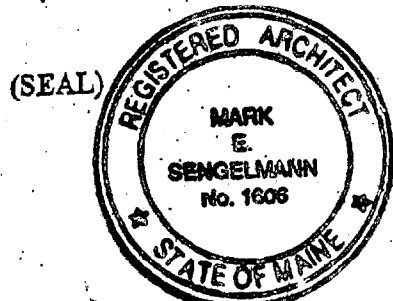

Signature Mark Sengelmann
Title PRINCIPAL
Firm PORT CITY DESIGN
Address 43 DEERING ST
PORTLAND ME 04101

As per Maine State Law:

\$50,000.00 or more in new construction, repair, expansion, addition, or modification for Building or Structures, shall be prepared by a registered design Professional.

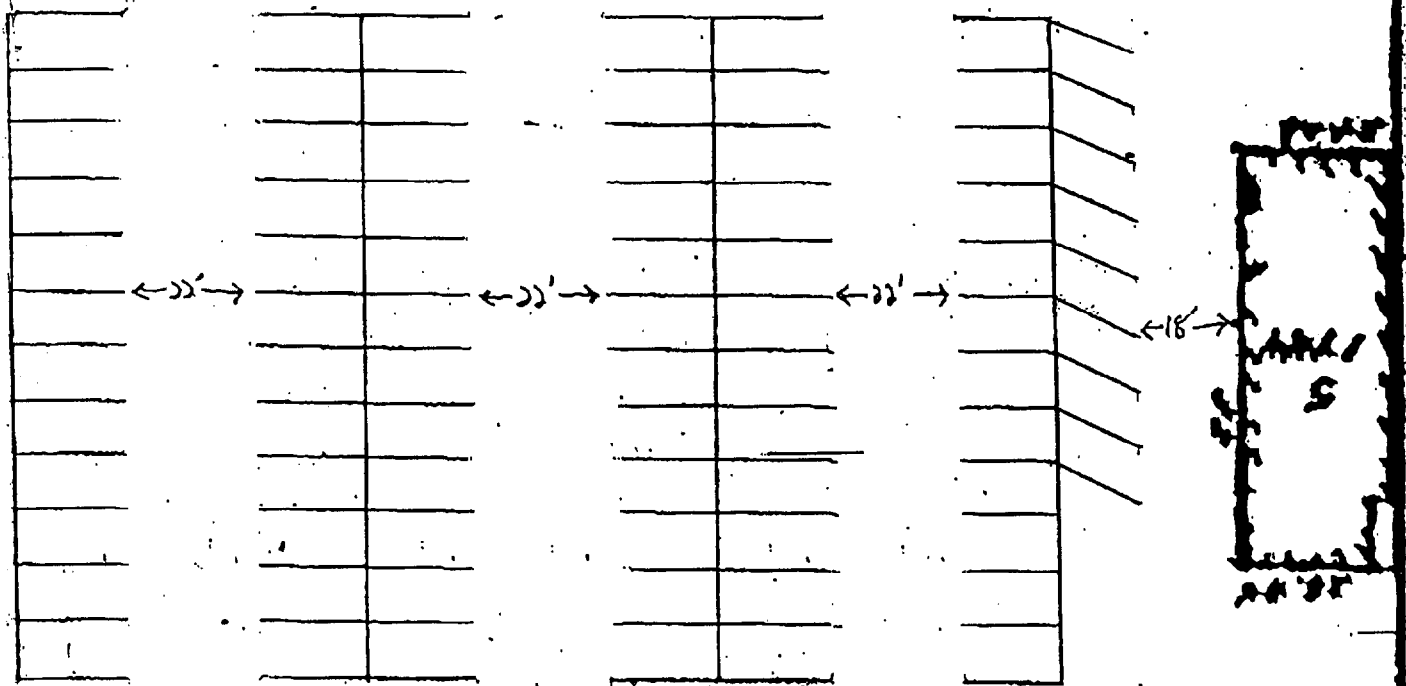
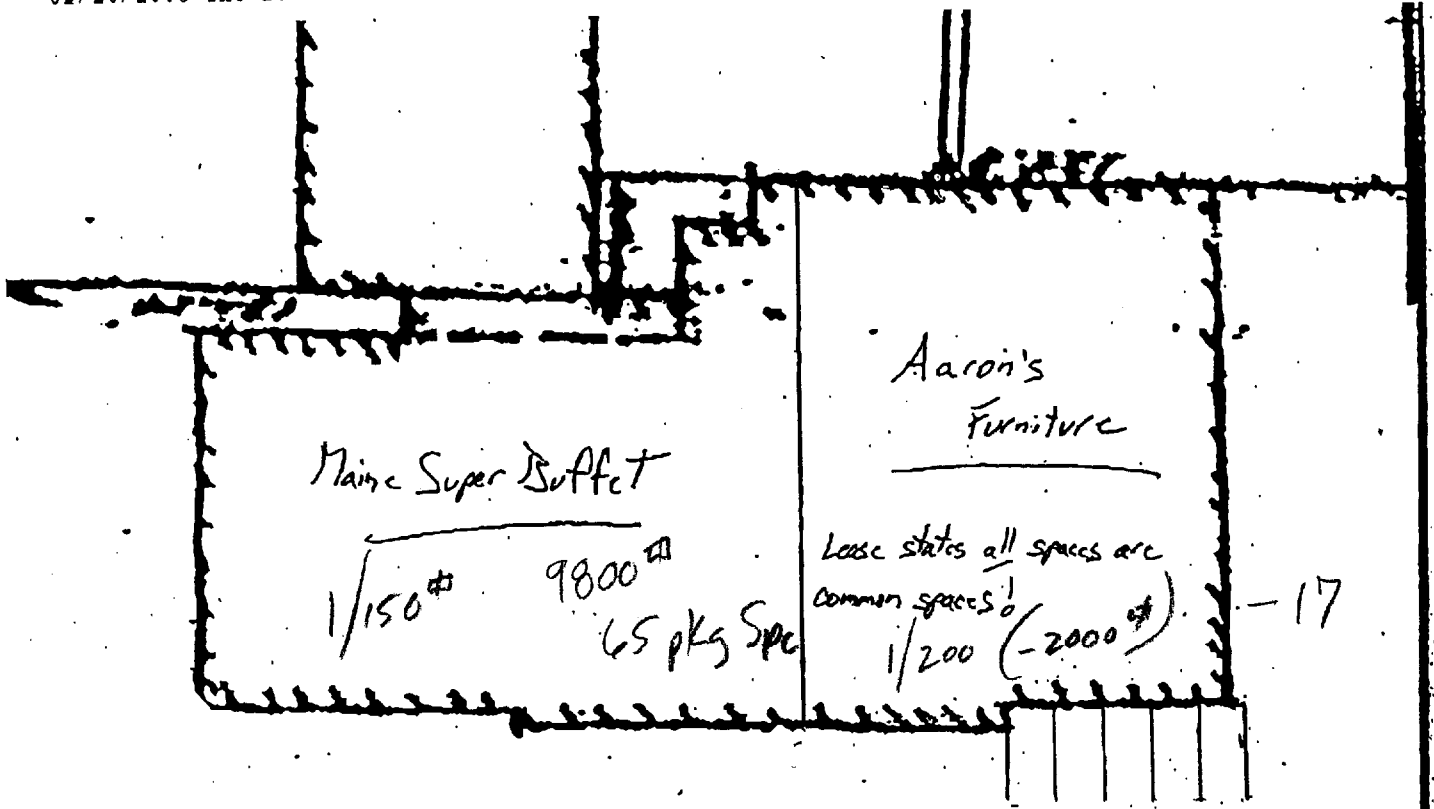

65
17
82

9'x18' Spaces
85 Spaces

Scale
1" = 30'

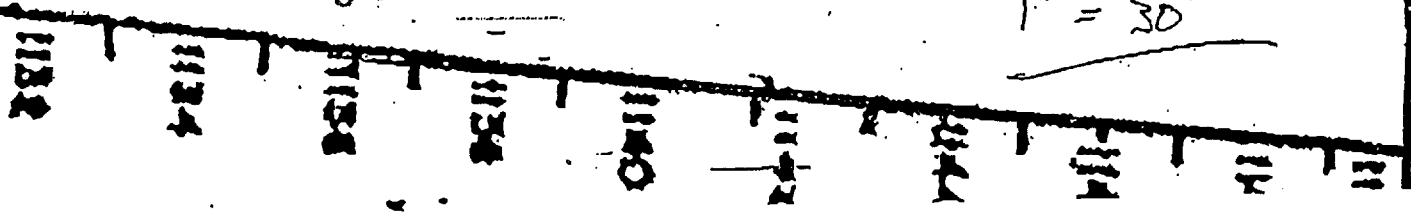



19 INDUSTRIAL PARK ROAD
 PO BOX 728
 SACO, ME 04072

TELEPHONE: (207) 282-7697
 FACSIMILE: (207) 283-4549

FACSIMILE TRANSMITTAL SHEET

TO: Sarah Hopkins	FROM: George Laplume
COMPANY: Portland Planning Dept.	DATE: 2/20/03
FAX NUMBER: 756-8258	TOTAL NO. OF PAGES INCLUDING COVER: 1
PHONE NUMBER: 874-8720	SENDER'S REFERENCE NUMBER:
RE: Aaron's Furniture	YOUR REFERENCE NUMBER:

URGENT
 FOR REVIEW
 PLEASE COMMENT
 PLEASE REPLY
 PLEASE RECYCLE

NOTES/COMMENTS:

Sarah,

Per your request, here are the square footages of both tenants:

Maine Super Buffet: 9,800sf
 Aaron's Furniture: 5,517sf (4,150sf showroom—1,367sf clearance / storage)

Please call with any questions.

Thanks,
 George Laplume

NOTICE OF CONFIDENTIALITY: This facsimile transmittal is intended solely for the use of the individual(s) or entity to which it is addressed and may contain information which is privileged, confidential, and exempt from disclosure under applicable law. If you are not the intended recipient or an employee or agent of the intended recipient, any dissemination, distribution, and/or copying of this transmittal, in whole or in part, is strictly prohibited. If you have received this transmittal in error, please telephone immediately to arrange for return of this transmittal at no cost to you. Thank you.

Description of Proposed Development:

- old trailer bldg was subdivided "Name Super Market" is on left side, Access furniture will be brought

Please Attach Sketch/Plan of Proposal/Development

Criteria for Exemptions:

See Section 14-523 (4) on back side of form

- a) Within Existing Structures; No New Buildings, Demolitions or Additions
- b) Footprint Increase Less Than 500 Sq. Ft.
- c) No New Curb Cuts, Driveways, Parking Areas
- d) Curbs and Sidewalks in Sound Condition/Comply with ADA
- e) No Additional Parking/ No Traffic Increase
- f) No Stormwater Problems
- g) Sufficient Property Screening
- h) Adequate Utilities

Applicant's Assessment (Yes, No, N/A)	Planning Office Use Only
<i>Yes</i>	<input checked="" type="checkbox"/>
<i>N/A</i>	<input checked="" type="checkbox"/>
<i>N/A</i>	<input checked="" type="checkbox"/>
<i>will add sidewalk at new entrance does</i>	<input checked="" type="checkbox"/>
<i>N/A</i>	<input checked="" type="checkbox"/>
<i>N/A</i>	<input checked="" type="checkbox"/>
<i>N/A</i>	<input checked="" type="checkbox"/>
<i>Yes</i>	<input checked="" type="checkbox"/>

Planning Division Use Only

Exemption Granted Partial Exemption _____ Exemption Denied _____

Provided parking meets zoning requirement

Planner's Signature *Sarah Hodgson*

Date *2/27/03*

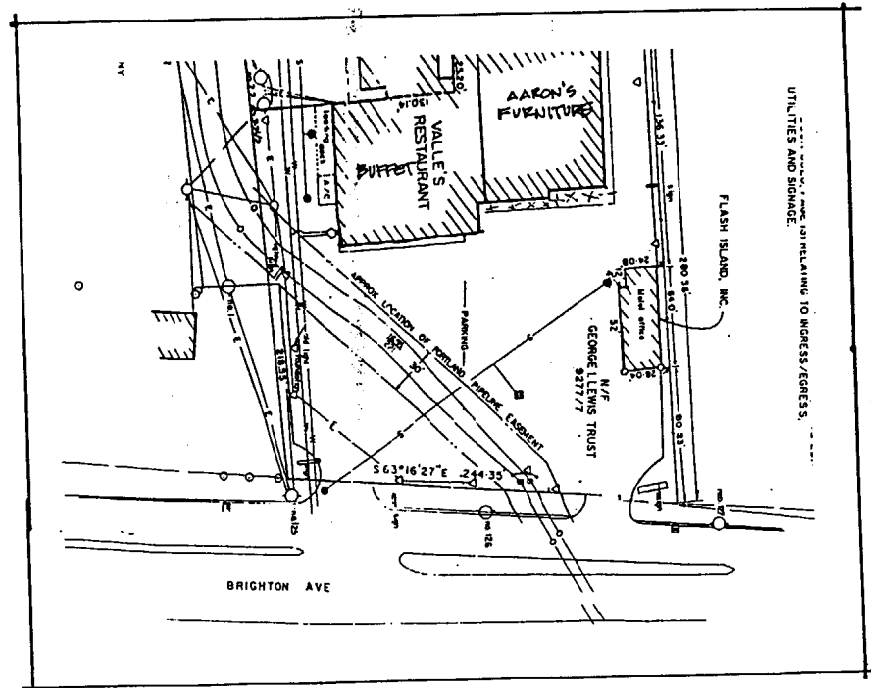
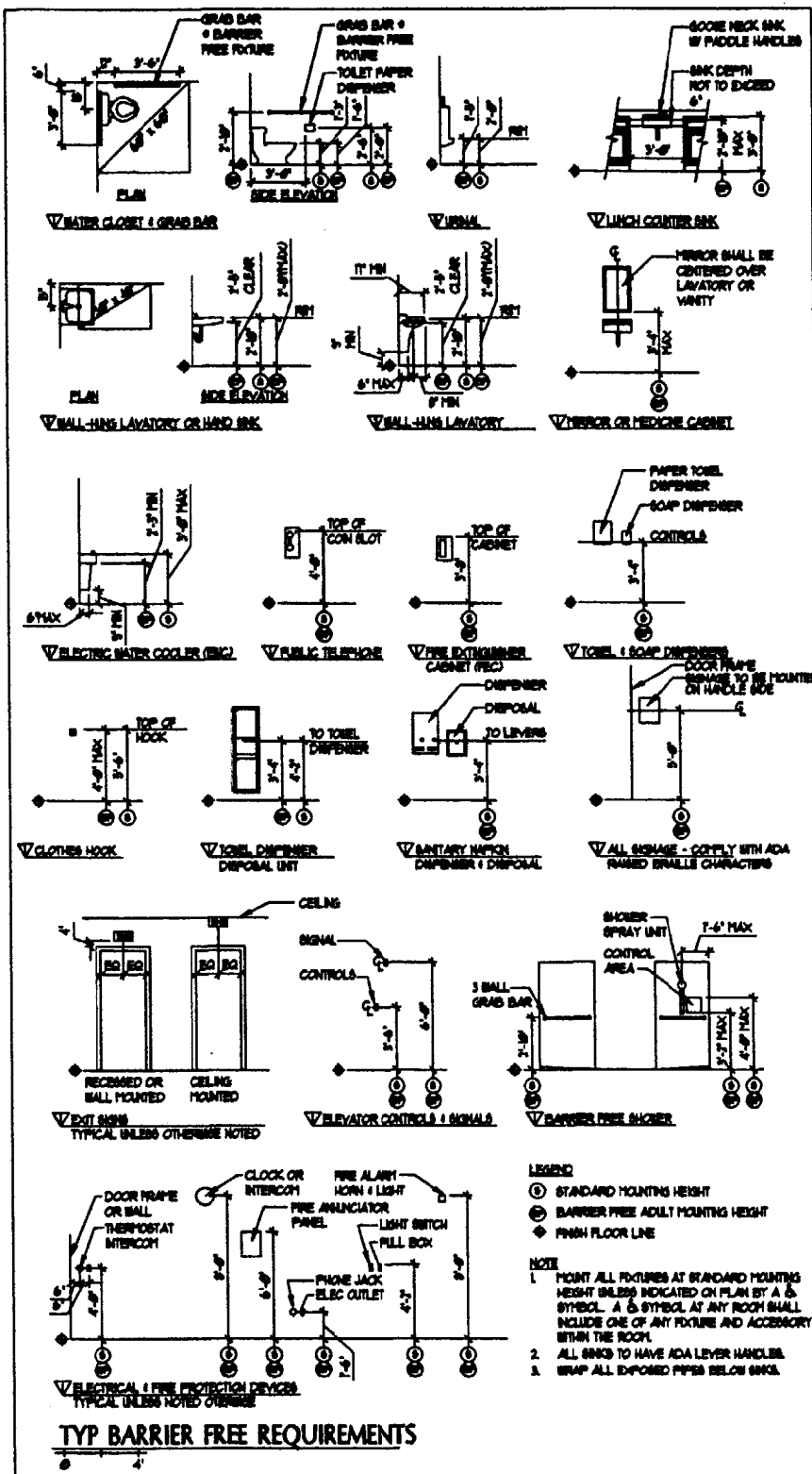

GENERAL NOTES

1. ALL MATERIALS, COMPONENTS, AND WORK ARE NEW AND SHALL BE PROVIDED IN THIS CONTRACT BY THE CONTRACTOR UNLESS NOTED OTHERWISE.
2. ALL WORK INCLUDED IN THIS CONTRACT SHALL CONFORM TO ALL STATE, NATIONAL AND OTHER CODES AND ORDINANCES WHICH APPLY TO THIS PROJECT.
3. IT IS THE INTENT AND MEANING OF THESE DRAWINGS THAT THE CONTRACTOR AND EACH SUBCONTRACTOR PROVIDE ALL LABOR, MATERIALS, TRANSPORTATION, SUPPLIES, EQUIPMENT, ETC. TO OBTAIN A COMPLETE JOB TO INDUSTRY STANDARD IN A PROFESSIONAL WORKMANLIKE MANNER.
4. THE CONTRACTOR SHALL FIELD VERIFY ALL EXISTING CONDITIONS AND REPORT ANY DISCREPANCY(IES) IMMEDIATELY TO THE ARCHITECT.
5. AT THE END OF EACH WORKING DAY, THE CONSTRUCTION SITE SHALL BE LEFT IN A NEAT AND CLEAN MANNER.
6. THE CONTRACTOR SHALL BE RESPONSIBLE FOR OBTAINING ALL PERMITS WHICH ARE REQUIRED FOR THE SATISFACTORY COMPLETION OF THE WORK AND FOR PAYING ALL FEES, HOOK UP CHARGES, ETC. (STATE FIRE MARSHAL PERMIT BY OWNER).
7. THE CONTRACTOR SHALL OBTAIN APPROVAL FROM THE OWNER FOR THE SEQUENCE AND TIMING OF OPERATIONS PRIOR TO COMMENCING WORK. AREAS FOR STAGING ETC. MUST BE APPROVED BY THE OWNER.
8. THE CONTRACTOR SHALL DISPOSE OF AND / OR RECYCLE ANY CONSTRUCTION DEBRIS FROM THE PROJECT SITE AS REQUIRED BY THE STATE. THE CONTRACTOR SHALL BE RESPONSIBLE FOR OBTAINING DISPOSAL PERMITS WHICH ARE REQUIRED. CONSTRUCTION DEBRIS FROM THE PROJECT SITE SHALL BE IMPROVED OF IN A STATE APPROVED LANDFILL.
9. ROOM NUMBERS ON THE DRAWING ARE FOR COORDINATION PURPOSES AND DO NOT NECESSARILY CORRESPOND TO ACTUAL ROOM NUMBERS.
10. DUTY OF COOPERATION: RELEASE OF THESE PLANS CONTEMPLATES FURTHER COOPERATION AMONG THE OWNER, THE CONTRACTOR, THE ARCHITECT AND HIS CONSULTANTS. DESIGN AND CONSTRUCTION ARE COMPLEX. ALTHOUGH THE ARCHITECT AND HIS CONSULTANTS HAVE PERFORMED THEIR SERVICES WITH DUE CARE AND DILIGENCE, THEY CANNOT GUARANTEE PERFECTION. COMMUNICATION IS IMPERFECT, AND EVERY CONTINGENCY CANNOT BE ANTICIPATED. ANY AMBIGUITY OR DISCREPANCY DISCOVERED BY THE USE OF THESE PLANS SHALL BE REPORTED IMMEDIATELY TO THE OWNER. FAILURE TO NOTIFY THE OWNER COMPOUNDS MISUNDERSTANDING AND MAY INCREASE CONSTRUCTION COSTS. A FAILURE TO COOPERATE BY A SIMPLE NOTICE TO THE OWNER SHALL RELIEVE THE OWNER AND THE ARCHITECT FROM RESPONSIBILITY FROM ALL COSTS.
11. THESE DRAWINGS DO NOT INCLUDE THE NECESSARY COMPONENTS FOR CONSTRUCTION SAFETY. THE GENERAL CONTRACTOR SHALL PROVIDE FOR THE SAFETY, CARE OF UTILITIES AND ADJACENT PROPERTIES DURING CONSTRUCTION, AND SHALL COMPLY WITH STATE AND FEDERAL SAFETY REGULATIONS.
12. ALL MATERIALS AND WORK SHALL BE GUARANTEED FOR A MINIMUM OF ONE YEAR FROM THE DATE OF FINAL PAYMENT.
13. ALL SIGNAGE IN PUBLIC AREAS SHALL HAVE RAISED BRILLE CHARACTERS.
14. ALL PIPES / CONDUIT SHOULD BE CONCEALED EXCEPT IN UNFINISHED LOCATIONS UNLESS NOTE OTHERWISE.
15. DO NOT SCALE DRAWINGS.
16. TENANT LEASE SPACE TO BE FULLY SPRINKLED PER NFPA.

PORT CITY DESIGN

43 DEERING STREET
PORTLAND, ME 04101
PHONE: 207.761.5800
FAX: 207.761.5808
mark@portcitydesign.net

© COPYRIGHT
Any use or reproduction of the contents of this document is not permitted without written permission of PORT CITY DESIGN.

PERMITTING DOCUMENTS

Aaron's Furniture
1140 Brighton Avenue
Portland ME 04102

JOB: 03206

ISSUE DATE	
PRELIM.	-
FINAL	3-14-03
RFI/O	NR
CD's	3-14-03
REVISION	-
PRINT	3-14-03

NOTES & PLAN
T-1

HC/TOILET ROOM NOTES

1. HC toilets to be 16 GPF AM. STD. ADA, floor mounted Cadet II, 17" H, E.L.A. # 2216143.
2. +32" AMSTBADA Ellipse lavatory #0476028 with lever handles. Wrap pipes below.
3. Bevel edged mirror 18" x 24", + 36" AFF, direct glze.
4. Toilet paper, soap, towel bars, coat hooks, etc., furnished and installed by owner.
5. Toilet paper holder + 20" AFF, 36" from floor wall.
6. Provide ceiling exhaust fan in each Toilet Room.
7. 1 1/4" dia. grab bars to meet ADA mounted + 34" AFF.

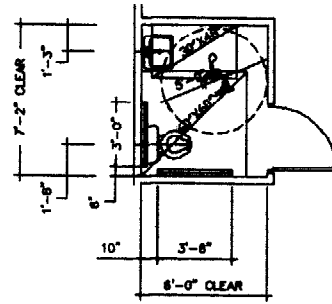

BASEMENT FLOOR PLAN
SCALE: 1/4" = 1'-0"

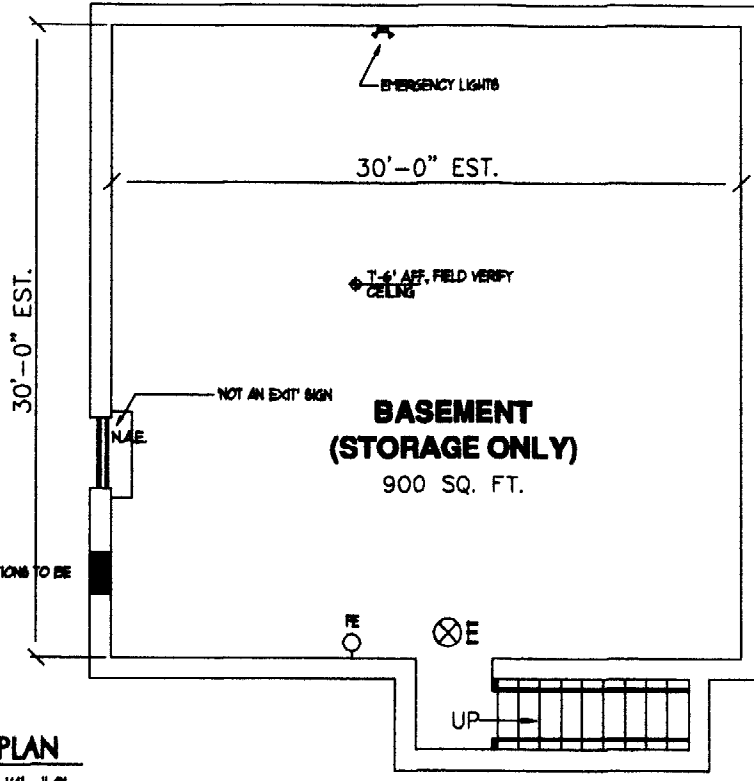

EXISTING 3066 DOOR TO BE WELDED SHUT AND FACED OVER II GIB ON INTERIOR

Notes: - ALL FIRE WALL PENETRATIONS TO BE COMPLETELY SEALED TO MAINTAIN RATING.

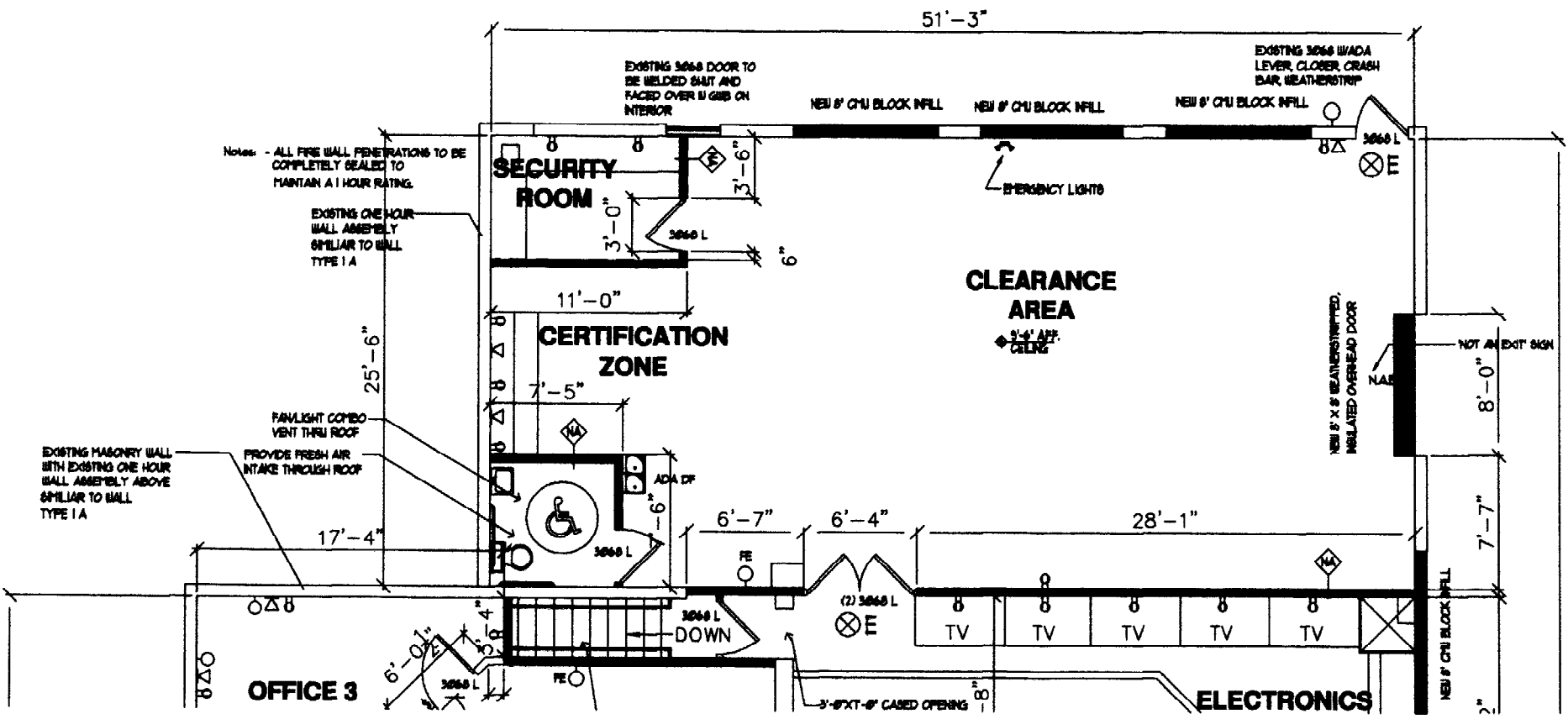
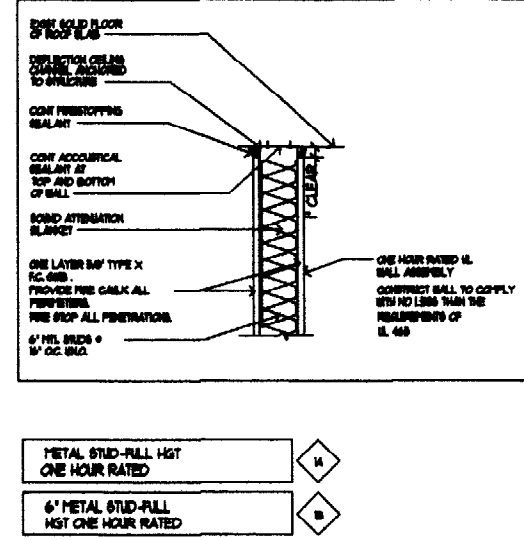
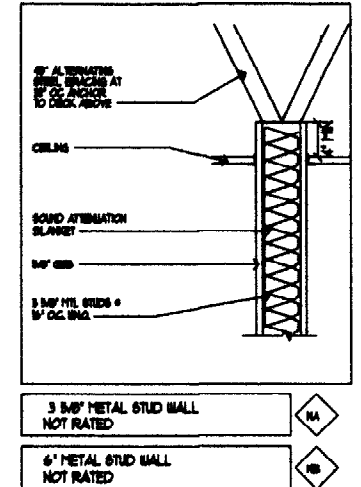

Notes: - ALL FIRE WALL PENETRATIONS TO BE COMPLETELY SEALED TO MAINTAIN A 1 HOUR RATING.

EXISTING ONE HOUR WALL ASSEMBLY SIMILAR TO WALL TYPE I A

EXISTING MASONRY WALL WITH EXISTING ONE HOUR WALL ASSEMBLY ABOVE SIMILAR TO WALL TYPE I A

PROVIDE FRESH AIR INTAKE THROUGH ROOF

REAR FLOOR PLAN
SCALE: 1/4" = 1'-0"

- LEGEND**
- ⚡ EMERGENCY LIGHT
 - ⊗ FIRE EXTINGUISHER
 - ⊙ EXIT SIGN
 - ⊞ FULL STATION
 - ⊞ HORNSTROKE
 - ⊞ NOT AN EXIT SIGN II RAISED BRILLE
 - ⊞ VAN ACCESSIBLE

PORT CITY DESIGN

43 DEERING STREET
PORTLAND, ME 04101
PHONE: 207.761.8800
FAX: 207.761.8898
mark@portcitydesign.net

© COPYRIGHT
Reproduction or reproduction of the contents of this document is not permitted without written permission of PORT CITY DESIGN

PERMITTING DOCUMENTS

Aaron's Furniture
1140 Brighton Avenue
Portland ME 04102

Job: 03206

ISSUE DATE	
PRELIM.	-
FINAL	3-14-03
SP/0	NR
C.D.'s	3-14-03
REVISION	-
PRINT	3-14-03

REAR AND BASEMENT FLOOR PLANS
A-2

Notes - ALL FIRE WALL PENETRATIONS TO BE CORRECTLY SEALED TO MAINTAIN 1 HOUR RATING.
 EXISTING ONE HOUR WALL ASSEMBLY REFER TO WALL TYPE I/A

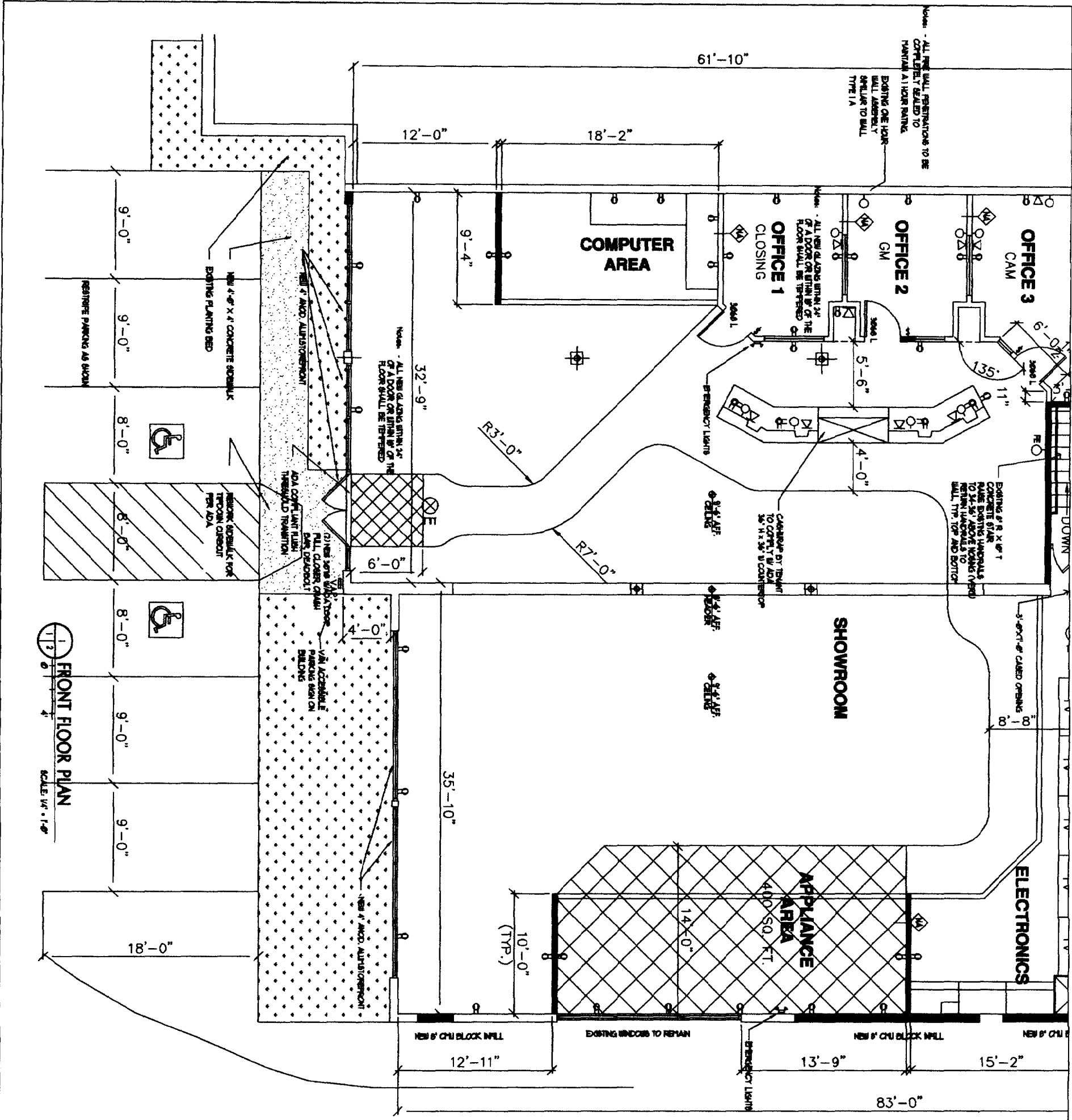

FRONT FLOOR PLAN
 SCALE 1/8" = 1'-0"

LEGEND

- ☐ BRENDACT LIGHT
- FIRE EXTINGUISHER
- DOT SIGN
- FALL STATION
- ▲ HORIZONTAL
- ▲ NOT AN DOT SIGN
- ▲ RAMPED SHALLES
- ▲ VAN ACCESSIBLE

3 BRK METAL STD WALL NOT RATED

6" METAL STD WALL NOT RATED

ONE HOUR RATED METAL STD WALL NOT RATED

ONE HOUR RATED METAL STD WALL NOT RATED

ISSUE DATE

PRELIM	-
FINAL	3-14-03
REVISED	NR
CD'S	3-14-03
REVISION 1	-
PRINT	3-14-03

Job: 03206

Aaron's Furniture
 1140 Brighton Avenue
 Portland ME 04102

PERMITTING DOCUMENTS

COMPYRIGHT

48 DERRING STREET
 PORTLAND, ME 04103
 PHONE: 207.761.5000
 FAX: 207.761.5005
 www.aaronspc.com

FRONT FLOOR PLAN
A-1

Aaron's

SALES & LEASE OWNERSHIP *For Less!*



1140 BRIGHTON AV.
 PORTLAND, ME 04102
 F345

NOTICE:

THE DESIGN AND LAYOUT OF THE DRAWINGS ARE CONSISTENT OF ALL CURRENT AARON'S SALES AND LEASE OWNERSHIP STORES.

THE DRAWINGS HAVE BEEN UPDATED WITH THE MOST CURRENT INTERIOR SPECIFICATIONS.

NO DEVIATION FROM THESE PRINTS WILL BE PERMITTED WITHOUT WRITTEN CONSENT.

03 0087
 265 3004
 1140 Brighton

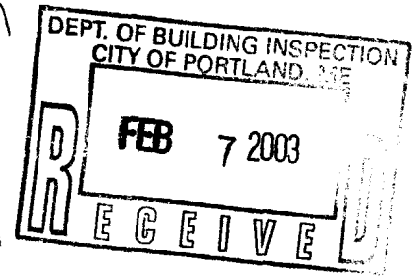

INDEX	
PAGE	DESCRIPTION
D1	COVER SHEET
D2	BUILDING SCHEDULES
D3	FLOOR PLAN
D4	DIMENSION PLAN
D5	ELECTRICAL PLAN
D6	CONSTRUCTION ELECTRICAL DETAILS
D7	CONSTRUCTION DETAILS
D8	CONSTRUCTION DETAILS
D9	DEMOLITION PLAN

THESE DRAWINGS ARE PROVIDED FOR INFORMATIONAL PURPOSES ONLY. AARON'S DOES NOT WARRANT OR REPRESENT THAT THE MATERIAL IS UP-TO-DATE OR CONFORMS TO ANY APPLICABLE LOCAL, STATE OR FEDERAL LAWS. REMEMBER, IT IS ULTIMATELY YOUR RESPONSIBILITY, AS A LICENSEE FRANCHISEE, TO CONDUCT YOUR BUSINESS IN COMPLIANCE WITH ALL LAWS AND REGULATIONS. WE ENCOURAGE YOU TO CONSULT WITH AN ATTORNEY TO DETERMINE YOUR COMPLIANCE WITH APPLICABLE LAWS AND REGULATIONS. THESE DRAWINGS AND ANY PERMITTED REPRODUCTIONS IN WHOLE OR IN PART ARE THE SOLE PROPERTY OF AARON'S. THEY SHALL NOT BE REPRODUCED OR CONVEYED IN ANY MANNER TO ANY THIRD PARTY. THIS DRAWING IS NOT TO BE USED ON ANY OTHER PROJECTS UNLESS SPECIFICALLY INDICATED HEREIN WITHOUT WRITTEN PERMISSION FROM AND DUE COMPENSATION TO AARON'S. PRIOR TO CONSTRUCTION IT MAY BE REQUIRED TO HAVE A SET OF PROFESSIONAL SEALED DRAWINGS MADE FOR PERMITS.

Aaron's
SALES & LEASE OWNERSHIP For Less!

309 East Paces Ferry Road
 Atlanta, Georgia 30305
 Phone Number: (678) 402-3000

STORE NO.	F345
LOCATION	PORTLAND ME
DRAWING NO.	D1
START DATE	01/23/03
DATE	01/23/03
DESCRIPTION	C.S.G.
REVISIONS	
NUMBER	
DESCRIPTION	
DATE	

bind here

AARON'S

SALES & LEASE OWNERSHIP For Less!



THESE DRAWINGS ARE PROVIDED FOR INFORMATIONAL PURPOSES ONLY. AARON'S DOES NOT WARRANT OR REPRESENT THAT THE MATERIAL IS UP-TO-DATE OR CONFORMS TO ANY APPLICABLE LOCAL, STATE OR FEDERAL LAWS. HOWEVER, IT IS THE CLIENT'S RESPONSIBILITY, AS A LICENSED FRANCHISEE, TO CONDUCT YOUR BUSINESS IN COMPLIANCE WITH ALL APPLICABLE LAWS AND REGULATIONS. WE ENCOURAGE YOU TO CONSULT WITH APPLICABLE LAWS AND YOUR CONFERENCE WITH APPLICABLE LAWS AND REGULATIONS. THESE DRAWINGS AND ANY PERMITTED REVISIONS IN WHOLE OR IN PART ARE THE SOLE PROPERTY OF AARON'S. THEY SHALL NOT BE REPRODUCED OR CONVEYED IN ANY MANNER TO ANY OTHER PARTY. THIS DRAWING IS NOT TO BE USED ON ANY OTHER PROJECTS UNLESS SPECIFICALLY INDICATED HEREIN WITHOUT WRITTEN PERMISSION FROM AARON'S. ANY AND ALL REVISIONS PRIOR TO CONSTRUCTION IT MAY BE REQUIRED TO HAVE A SET OF PROFESSIONAL SEALED DRAWINGS MADE FOR PERMITS.

AARON'S

SALES & LEASE OWNERSHIP For Less!

309 East Paces Ferry Road
 Atlanta, Georgia 30305
 Phone Number: (678) 402-3000

FLOOR PLAN KEY NOTES

- | Symbols | Description |
|---------|--|
| △ | APPLIANCE AREA, SEE SHEET (D7) FOR DETAILS. |
| △ | ELECTRONICS AREA, SEE SHEET (D6) FOR DETAILS. |
| △ | OFFICE AREA, SEE SHEET (D8) FOR DETAILS. |
| △ | JEWELRY CASE AND PREFABRICATED SALES COUNTER. SEE SHEET (D6) FOR DETAILS. |
| △ | SOFFIT WALL IN APPLIANCE, ELECTRONICS AND COMPUTER AREA SEE SHEET (D7) FOR DETAILS, IF APPLICABLE. |
| △ | SECURITY ROOM, SEE SHEET (D6) FOR DETAILS. |
| △ | REST ROOMS, SEE SHEET (D8) FOR DETAILS. |
| △ | CERTIFICATION ZONE, SEE SHEET (D6) FOR DETAILS. |
| △ | PLACE A WATER COOLER NEAR THE REST ROOMS, IF REQUIRED BY CODE. |
| △ | SHOWROOM COLUMNS, SEE SHEET (D6) FOR DETAILS. |
| △ | INSTALL HVAC AND DUCTWORK AS NEEDED IN THE PREMISES. A/V IS NOT REQUIRED IN CLEARANCE AREA. DUCTWORK IS REQUIRED FOR NEW OFFICES WITH RETURNS. |
| △ | PROVIDE AND INSTALL THE FOLLOWING:
LOOKSET HARDWARE AND DEAD BOLT AT SECURITY ROOM (STORAGE FUNCTION)
PRIVACY HARDWARE INSTALLED IN REST ROOMS.
PASSAGE HARDWARE INSTALLED IN OFFICES.
ALL HARDWARE TO BE STANDARD BUILDER'S GRADE W/ POLISHED BRASS FINISH. |
| △ | ALL REAR EXIT DOORS ARE TO HAVE DETEX PANIC HARDWARE ADDED IF NO PANIC HARDWARE EXISTS. IF NON DETEX PANIC HARDWARE EXISTS (VON DUPRIN, ETC.), AN AUDIBLE EXIT ALARM IS TO BE ADDED. INSTALL A DETEX ALARM (PANIC BAR) ON ALL EXTERIOR DOORS REQUIRED BY CODE. ALL NEW DOORS ARE TO HAVE DETEX PANIC HARDWARE ADDED. |
| △ | PROVIDE A NIGHT DROP (1/2" x 6" AT 3'-0" A.F.F.) IN GLASS AT LEFT OF DOORS (OR WHERE PRACTICAL). |
| △ | DOUBLE WOODEN DOORS (3'-0" x 8'-0") ADD 4' OF PLEXIGLAS TO EACH DOOR BOTTOM HALF (SHOWROOM SIDE STAIN GRADE SOLID CORE W/METAL FRAMES). |
| △ | STOCK & SALE DOORS ARE TO HAVE CLOSERS WITH A HOLD OPEN FEATURE (NO KICK DOWNS). BRASS PUSH PLATES ON THE SALES SIDE AND PULL HANDLES ON THE STOCK SIDE. NO PASSAGE HARDWARE OR FLUSH BOLTS ARE NECESSARY. |
| △ | FEATURE DISPLAY AREA, PAINT WALL AND ADJACENT WING WALL FACE (CABINET) FROM FLOOR TO PAINTED SIGN BAND. |
| △ | INSTALL 4" x 5" 5/8" PLYWOOD TELEPHONE BOARD NEXT TO ELECTRICAL PANEL, IF NOT EXISTING. |
| △ | VINYL REDUCER STRIP BETWEEN CARPET TO VCT AND VCT TO BACK ROOM. SEE SHEET (D7) FOR TRANSITION DETAIL. |
| △ | INSTALL FIELD CARPET IN SHOWROOM AND OFFICES. |
| △ | INSTALL AISLE CARPET IN SHOWROOM. |
| △ | INSTALL TILE IN SHOWROOM (APPLIANCE AREA AND ENTRANCE). |
| △ | ALL EXISTING DOORS TO BE REUSED ARE TO BE CLEANED, SERVICED, AND ADJUSTED TO ENSURE PROPER AND TROUBLE FREE OPERATION. |

NO.	ROOM	FLOOR	BASE	WALLS	TRM	DOORS
ENTRY	VCT-1, VCT-2	N/A	P-1	P-5	N/A	
SALES	C-1, C-2	WB-1, WB-2	P-1, P-2, P-4	P-3, P-6	P-7	
BACK ROOM	EXISTING CONCRETE	WB-1	P-1	P-6	P-8	
SECURITY ROOM	EXISTING CONCRETE	WB-1	P-1	P-6	P-8	
OFFICE #1	C-1	WB-1	P-1	P-6	P-7	
OFFICE #2	C-1	WB-1	P-1	P-6	P-7	
OFFICE #3	C-1	WB-1	P-1	P-6	P-7	
RESTROOM (S)	VCT-1	WB-1	P-1	P-6	P-8	
APPLIANCE AREA	VCT-1, VCT-2	WB-3	P-4	P-5	P-7	
ELECTRONICS AREA	C-2	WB-1	P-4	NONE	N/A	

MARK	DESCRIPTION
ACT-1	ARMSTRONG, 2'x4' LAY-IN CEILING TILE, 'SOUND LOOK II, #2767, WHITE IN ARMSTRONG 15/16" 'PRELUDE' SUSPENSION SYSTEM, WHITE. USE FIRE GUARD WHERE REQUIRED BY CODE.

MARK	DESCRIPTION
C-1	STOREFLOORS, FIELD CARPET
C-2	STOREFLOORS, AISLE CARPET

MARK	DESCRIPTION
T-1	ROPPE CARPET-TILE JOINER 177-10C BLACK, CARPET TO VINYL
T-2	JOHNSONITE, 'BLACK' #40, RRS-40-C, 1/8" VINYL REDUCER STRIP

SOFFIT	=====
SOFFIT EXISTING	=====
WALL INTERIOR	=====
EXIST. WALL EXTERIOR	=====
WALL EXTERIOR	=====
DEMOLITION	=====

ACoust	INSUL	INSULATION	
ADJ	ADJUSTABLE	JT	JOINT
A.F.F.	ABOVE FINISH FLOOR	LAY	LAVATORY
ALUM	ALUMINUM	LAM	LAMINATE
ALT.	ALTERNATE	L.L.	LANDLORD
AMP	AMPERE	M.C.	MASONRY OPENING
APPROX	APPROXIMATE	M.A.	MAXIMUM
BLK.	BLOCK	MECH.	MECHANICAL
BOT.	BOTTOM	MFG.	MANUFACTURER(S) (S)
BRG.	BEARING	MIN.	MINIMUM
BTU.	BRITISH THERMAL UNIT(S)	MISC.	MISCELLANEOUS
C.J.	CONTROL JOINT	MTL.	METAL
C.D.	CLEANOUT	N.E.C.	NATIONAL ELECTRICAL CODE
C.T.	CERAMIC TILE	N.I.C.	NOT IN CONTRACT
CLG.	CEILING	N.I.R.	NOT INCLUDED IN REMODEL
CLO.	CLOSET	N.T.S.	NOT TO SCALE
CONC.	CONCRETE	O.C.	ON CENTER
CONT.	CONTINUOUS	OPNG.	OPENING
DET.	DETAIL (S)	O.D.	OUTSIDE DIAMETER
DIM.	DIMENSION (S)	P.V.C.	POLYVINYL CHLORIDE
DN.	DOWN	PL.	PLATE
DO.	DITTO	PT.	POINT
EA.	EACH	R.	RISEN, RADIUS
ELEV.	ELEVATION	REQD.	REQUIRED
EQ.	EQUAL	S.S.	STAINLESS STEEL
EXH.	EXHAUST	SAN.	SANITARY
EXT.	EXTERIOR	SCHED.	SCHEDULE
EXIST.	EXISTING	SHT.	SHEET
EXPAN.	EXPANSION	SIM.	SIMILAR
F.D.	FLOOR DRAIN	SPEC.	SPECIFICATIONS
F.E.	FIRE EXTINGUISHER	STOR.	STORAGE
FIN.	FINISH	T.G.C.	TENANT'S GENERAL CONTRACTOR
FL.	FLOOR	TEN.	TENANT
GA.	GAUGE	TOIL.	TOILET
GALV.	GALVANIZED	TYP.	TYPICAL
GYP.	GYPSPUM	U.L.	UNDERWRITER'S LABORATORY
HDW.	HARDWARE	V.	VOLT (S)
H.M.	HOLLOW METAL	V.C.T.	VINYL COMPOSITION TILE
H.W.	HOT WATER	W/	WITH
HORIZ.	HORIZONTAL	W.C.	WATER CLOSET
HT.	HEIGHT	W.M.W.	WELDED WIRE MESH
I.D.	INSIDE DIAMETER	W.H.	WATER HEATER

MARK	DESCRIPTION
ACT-1	ARMSTRONG, 2'x4' LAY-IN CEILING TILE, 'SOUND LOOK II, #2767, WHITE IN ARMSTRONG 15/16" 'PRELUDE' SUSPENSION SYSTEM, WHITE. USE FIRE GUARD WHERE REQUIRED BY CODE.

MARK	DESCRIPTION
WB-1	ARMSTRONG, 'SHORELINE' #74, 4" RUBBER BASE, W/ MATCHING PREFAB. CORNERS
WB-2	ARMSTRONG, 'RAISIN RED' #10, 4" RUBBER BASE (AT CASHWRAP ONLY)
WB-3	ARMSTRONG, 'BLACK' #41, 4" RUBBER BASE (APPLIANCE AREA ONLY)

MARK	DESCRIPTION
P-1 (DRYWALL)	COLOR: #SW1109 'ARIA IVORY', FLAT FINISH, 2 COATS MIN. (DRYWALL) PRIMER: PREPRITE 200 WALL PRIMER 2 COATS MIN.
P-2 (DRYWALL)	COLOR: #SW1294 'CABERNET', FLAT FINISH, 2 COATS MIN. PRIMER: PREPRITE 200 WALL PRIMER 2 COATS MIN.
P-3 (CHAIR RAIL)	COLOR: #SW1294 'CABERNET', HIGH GLOSS FINISH, 2 COATS MIN. PRIMER: PREPRITE 200 WALL PRIMER 2 COATS MIN.
P-4 (DRYWALL)	COLOR: #SW1244 'RHYTHM II' 'BLUES', FLAT FINISH, 2 COATS MIN. PRIMER: PREPRITE 200 WALL PRIMER 2 COATS MIN.
P-5 (WOOD)	COLOR: #SW1244 'RHYTHM II' 'BLUES', HIGH GLOSS, 2 COATS MIN. PRIMER: PREPRITE QUICK SEAL ALKYD PRIMER 2 COATS MIN.
P-5 (METAL)	COLOR: #SW1244 'RHYTHM II' 'BLUES', HIGH GLOSS, 2 COATS MIN. PRIMER: DTM ACRYLIC PRIMER/FINISH 2 COATS MIN.
P-6 (WOOD)	COLOR: #SW1099 'KNUBBY WOOD', HIGH GLOSS FINISH, 2 COATS MIN. PRIMER: PREPRITE QUICK SEAL ALKYD PRIMER 2 COATS MIN.
P-6 (METAL)	COLOR: #SW1099 'KNUBBY WOOD', HIGH GLOSS FINISH, 2 COATS MIN. PRIMER: DTM ACRYLIC PRIMER/FINISH 2 COATS MIN.
P-7 (WOOD)	COLOR: CLEAR SATIN POLYURETHANE, TOP COATS (2 MIN.); WOODCLASSICS POLY-URETHANE VARNISH (A67 SERIES)

MARK	DESCRIPTION
P-1 (DRYWALL)	COLOR: #6704 'SOFT CLOUD', FLAT, 2 COATS MIN. PRIMER: BLANKET #1129 2 COATS MIN.
P-2 (DRYWALL)	COLOR: #6636-5 'CABERNET', FLAT FINISH, 2 COATS MIN. PRIMER: BLANKET #1129 2 COATS MIN.
P-3 (CHAIR RAIL)	COLOR: #6636-5 'CABERNET', HIGH GLOSS FINISH, 2 COATS MIN. PRIMER: BLANKET #1129 2 COATS MIN.
P-4 (DRYWALL)	COLOR: CUSTOM BLUE #3088 17/158 (AARONS BLUE), FLAT FINISH, 2 COATS MIN. FORMULA: 388 DEEP BASE, 22A, 2Y168, 7Y20C, 2Y12E. PRIMER: BLANKET #1129 2 COATS MIN.
P-5 (WOOD)	COLOR: CUSTOM BLUE #3088 17/158 (AARONS BLUE), HIGH GLOSS, 2 COATS MIN. FORMULA: 388 DEEP BASE, 22A, 2Y168, 7Y20C, 2Y12E. PRIMER: BLANKET #1129 2 COATS MIN.
P-5 (METAL)	COLOR: CUSTOM BLUE #3088 17/158 (AARONS BLUE), HIGH GLOSS, 2 COATS MIN. FORMULA: 388 DEEP BASE, 22A, 2Y168, 7Y20C, 2Y12E. PRIMER: UNIVERSAL 2 COATS MIN.
P-6 (WOOD)	COLOR: #6705-2 'BEIGE CHIFFON', HIGH GLOSS FINISH, 2 COATS MIN. PRIMER: BLANKET #1129 2 COATS MIN.
P-6 (METAL)	COLOR: #6705-2 'BEIGE CHIFFON', HIGH GLOSS FINISH, 2 COATS MIN. PRIMER: UNIVERSAL 2 COATS MIN.
P-7 (WOOD)	COLOR: CLEAR SATIN POLYURETHANE, TOP COATS (2 MIN.); WOODCLASSICS POLY-URETHANE VARNISH (A67 SERIES)

MARK	DESCRIPTION
VCT-1	ARMSTRONG #51911 - CLASSIC WHITE
VCT-2	ARMSTRONG #51910 - CLASSIC BLACK

- ### GENERAL NOTES
- ALL DESIGN AND WORK SHALL BE PERFORMED IN STRICT COMPLIANCE WITH FEDERAL, STATE, AND LOCAL BUILDING CODE REQUIREMENTS, EXCEPT IN ACCORDANCE WITH ACCEPTED INDUSTRY STANDARDS. IT SHALL BE THE GENERAL CONTRACTOR'S RESPONSIBILITY TO INSURE THE PROCUREMENT OF ALL REQUIRED AND NECESSARY PERMITS AND APPROVALS PRIOR TO THE COMMENCEMENT OF ANY WORK.
 - UNLESS NOTED OTHERWISE, ALL NEW WALLS LOCATED BY ALIGNMENT NOTATIONS AND ALL WALLS NOT SPECIFICALLY DIMENSIONED SHALL BE PARALLEL AND/OR PERPENDICULAR TO EXISTING BUILDING WALLS.
 - CONTRACTOR IS RESPONSIBLE FOR CHECKING ALL FIELD CONDITIONS AND DIMENSIONS FOR ACCURACY AND CONFIRMING THAT THE WORK IS FEASIBLE AS SHOWN AND MEETS ALL APPLICABLE CODES BEFORE PROCEEDING WITH CONSTRUCTION. IF THERE ARE ANY QUESTIONS REGARDING THESE OR OTHER COORDINATION ISSUES, THE CONTRACTOR IS RESPONSIBLE FOR OBTAINING A CLARIFICATION FROM AARON'S BEFORE PROCEEDING.
 - ALL RESTROOM AND SHOWROOM FLOORS TO BE PREPARED AS REQUIRED TO ACCEPT NEW CARPET AND VCT.
 - THE GENERAL CONTRACTOR SHALL REMOVE ALL UNUSED WALL CONDUITS, SWITCH PLATES, TELEPHONE, ELECTRICAL WIRING, AND EQUIPMENT DURING DEMOLITION.
 - OUTLETS AND UTILITIES INDICATED ON THE PLAN ARE THE MINIMUM REQUIREMENTS. ADDITIONAL TELEPHONE OR ELECTRICAL UTILITIES MAY BE ADDED AS OPTIONS. EXISTING TELEPHONE JACKS NOT INDICATED ON PLAN TO BE REMOVED AND WALLS PATCHED. GENERAL CONTRACTOR TO VERIFY LOCATION OF ALL UTILITIES IN THE FIELD. ALL WIRING MUST MEET FIRE CODE REGULATIONS.
 - PROVIDE AND INSTALL FIRE EXTINGUISHERS AS REQUIRED BY THE LOCAL FIRE CODES.
 - ALL PAINTED SURFACES SHALL RECEIVE A PRIME COAT WITH A FINISH COAT (S) AS REQUIRED TO OBTAIN PROPER COVERAGE AND UNIFORM APPEARANCE.
 - THE GENERAL CONTRACTOR AND EACH SUBCONTRACTOR SHALL BE RESPONSIBLE FOR CHECKING EXISTING CONDITIONS AT THE JOB SITE BEFORE SUBMITTING PROPOSALS. SUBMISSION OF PROPOSALS SHALL BE TAKEN AS EVIDENCE THAT SUCH INSPECTIONS HAVE BEEN MADE.
 - PROVIDE A CUTOFF VALVE (APPROX. 6'-0" A.F.F.) AT POINT WHERE WATER ENTERS TENANT SPACE IF REQUIRED BY CODE.
 - ALL BLUE LETTERING AND NEON SIGNAGE MUST BE REMOVED (EXCEPT "OPEN" NEON WINDOW SIGNS). THESE WILL BE REPLACED WITH GOLD VENEER LOGO'S ORDERED FROM ADMINISTRATIVE WAREHOUSE, WHICH IS PART OF THE REMODEL EQUIPMENT PACKAGE.

ELECTRICAL PLAN KEY NOTES

- | SYMBOLS | DESCRIPTION |
|---------|---|
| ① | APPLIANCE AREA: INSTALL ONE DUPLEX OUTLET EVERY SIX FEET, OR CONTINUOUS PLUG MOLD. SEE THIS SHEET FOR PLACEMENT OF FLUORESCENT LIGHTING. PROVIDE THREE CIRCUITS FOR APPLIANCE AREA. |
| ② | ELECTRONICS AREA: INSTALL THREE J-BOX'S TO BE WIRED FOR PLUS MOLDING ON UNITS. 6" VERTICAL WIRE MOLD PER UNIT. INSTALL COAXIAL CABLE HOOKUP PER UNIT. IF NECESSARY, WIRE MOLDS PAINTED TO MATCH WALL. INSTALL 3 LAY-IN FIXTURES ON SEPARATE SWITCH. SEE THIS SHEET FOR PLACEMENT. PROVIDE FOUR CIRCUITS FOR ELECTRONICS AREA. |
| ③ | CERTIFICATION ZONE: TWO J-BOX'S STUBBED FROM THE MAIN ELECTRICAL PANEL. ONE WITH A 220 VOLT RECEPTACLE FOR RANGES AND ONE 220 VOLT FOR DRYERS. BOTH AT 30" OFF FLOOR. SEE SHEET (D6) FOR DETAILS. |
| ④ | CLEARANCE AREA: TWO 110 VOLT OUTLETS FOR TELEPHONE AND ALARM SYSTEM IN THE VICINITY OF ELECTRICAL PANEL. APPROVED OVERHEAD LIGHTING WITH SWITCH. INSTALL A 150/200 WATT HALOGEN (DUSK TO DAWN) LIGHT NEAR THE OVERHEAD DOOR. |
| ⑤ | OFFICE: ONE TELEPHONE JACK, ONE COMPUTER OUTLET, THREE 110 VOLT ELECTRICAL OUTLETS LOCATED ON THE OPPOSITE SIDE OF THE QUADRUPLE OUTLETS. ONE STANDARD LIGHT SWITCH TYPICAL FOR OFFICES. ONE OFFICE TO HAVE A DOOR BELL RECEIVER, MASTER CONTROL FOR ALARM. INSTALL A 110 VOLT DUPLEX OUTLET FOR SECURITY CAMERA ON OUTSIDE OF OFFICES. EL. 10'-0". |
| ⑥ | COUNTERS: PROVIDE POWER AND THE FOLLOWING SET-UP: ONE TELEPHONE JACK, ONE COMPUTER OUTLET AND QUADRUPLE OUTLET, TYPICAL FOR EACH COUNTER. SEE ELECTRICAL DETAIL FOR FRONT COUNTERS FOR CLARITY. WIRES AND CABLES SHOULD BE TRENCHED FROM OFFICES TO COUNTERS. 2 SEPARATE CIRCUITS. ONE FOR SERVER AND ONE FOR OTHER ELECTRONIC EQUIPMENT AT COUNTERS. SEE SHEET (D6) FOR DETAILS. |
| ⑦ | JEWELRY CASE: PROVIDE J-BOX ABOVE CEILING FOR INSTALLATION OF HALOGEN TRACK LIGHTING AT CEILING OVER JEWELRY CASE. PROVIDE LIGHTING FOR JEWELRY CASE. INSTALL SWITCH FOR BOTH INSIDE COUNTERS OF JEWELRY CASE. |
| ⑧ | REST ROOM: PROVIDE GFI GROUNDED OUTLETS AND ONE LIGHT SWITCH FOR REST ROOM LIGHT. |
| ⑨ | SECURITY ROOM: ONE 8' STRIP FLUORESCENT DOUBLE LAMP LIGHT WITH LIGHT SWITCH. INSTALL TWO DUPLEX OUTLET AT NORMAL HEIGHT. INSTALL ONE J-BOX AT CEILING LEVEL FOR SECURITY CAMERA. |
| ⑩ | SHOWROOM: PROVIDE AND INSTALL THE FOLLOWING LIGHT SWITCH REQUIREMENTS. LIGHT SWITCHES SHOULD BE PROVIDED FOR ALL SHOWROOM LIGHTS AT FRONT AND REAR OF SHOWROOM. SWITCH FOR LIGHTING IN MAX GALLERY. IF NECESSARY, SECURITY NIGHT LIGHTS SHOULD LIGHT 15% OF SHOWROOM WITH CONCENTRATION AT STORE FRONT GLASS AND AROUND OFFICE AREA. |
| ⑪ | ALL ELECTRICAL OUTLETS TO BE INSTALLED 18" A.F.F., 12" O.C. (TYP.). UNLESS NOTED OTHER WISE OR SPECIFIED BY LOCAL CODE REQUIREMENTS. COMPUTER CABLES TO BE INSTALLED SHALL BE TWISTED PAIR CATEGORY #5-BY FIE CODE. |
| ⑫ | REFER TO PLAN KEY NOTE 13 ON SHEET (D2) FOR PROCEDURES ON THE EXIST DOORS. |
| ⑬ | PROVIDE TWO CIRCUITS PER PLATFORM FOR COMPUTER AREA. |
| ⑭ | ADEQUATE POWER IS TO BE PROVIDED AT THE STORE FRONT FOR THE EXTERIOR SIGN. CONTACT SIGNAGE DEPARTMENT AT 813-884-1230 FOR SPECIFIC REQUIREMENTS. PROVIDE TWO CIRCUITS FOR SIGNAGE. |
| ⑮ | ADD J-BOX AT CEILING HEIGHT FOR FUTURE INTERIOR SIGNAGE ONE FOOT BACK FROM STORE FRONT, CENTERED ON FRONT GLASS SECTIONS. |
| ⑯ | INSTALL A TIMER AT THE ELECTRICAL PANEL FOR EXTERIOR SIGN. |
| ⑰ | INSTALL ALL NECESSARY EMERGENCY LIGHTS AND EXISTS INCLUDING SIGNAGE (USING EXISTING WHEN POSSIBLE) PER CODE. |

- ### ALTERNATIVES:
- PROVIDE QUOTE FOR INSULATED GLASS AT STORE FRONT EXCLUDING DOORS.
 - PROVIDE QUOTE FOR 2x4 FLUORESCENT FIXTURE WITH PARABOLIC LENS.
 - PROVIDE QUOTE FOR 2' x 2' GRID LAY-IN CEILING AT 12'-0" A.F.F..
 - PROVIDE QUOTE FOR FLOOR OUTLETS.

STORE NO.	F345
DRYING DATE	01/23/03
BY	C.S.G.
REVISED BY	
DATE	
DESCRIPTION	
NO.	
DESCRIPTION	
NO.	
DESCRIPTION	

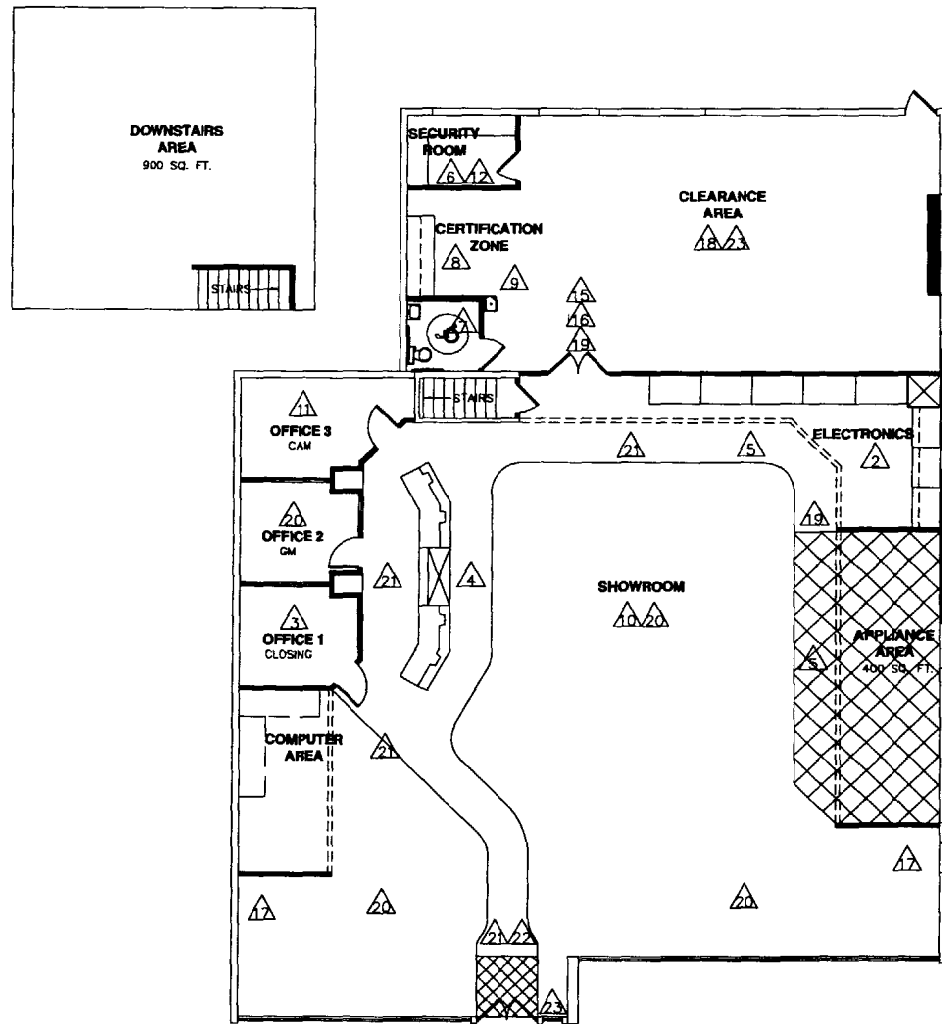

FLOOR PLAN

LEGEND

SOFFIT	=====
SOFFIT EXISTING	=====
WALL INTERIOR	=====
EXIST. WALL INTERIOR	=====
WALL EXTERIOR	=====

AREA COVERAGE	SQUARE FEET
SHOWROOM	4,150 SQ.FT.
CLEARANCE AREA	1,134 SQ.FT.
TOTAL	5,517 SQ.FT.

THE SQUARE FOOTAGE CALCULATIONS ARE COMPUTED WITH AUTOCAD AND ARE APPROXIMATE.

THESE DRAWINGS ARE PROVIDED FOR INFORMATIONAL PURPOSES ONLY. AARON'S DOES NOT WARRANT OR REPRESENT THAT THE MATERIAL IS UP-TO-DATE OR CONFORMS TO ANY APPLICABLE LOCAL, STATE OR FEDERAL LAWS. REMEMBER, IT IS ULTIMATELY YOUR RESPONSIBILITY, AS A LICENSED FRANCHISEE, TO CONDUCT YOUR BUSINESS IN COMPLIANCE WITH ALL LAWS AND REGULATIONS. WE ENCOURAGE YOU TO EMPLOY LOCAL COUNSEL TO DETERMINE YOUR CONFORMANCE WITH APPLICABLE LAWS AND REGULATIONS. THESE DRAWINGS AND ANY PERMITTED REPRODUCTIONS IN WHOLE OR IN PART ARE THE SOLE PROPERTY OF AARON'S. THEY SHALL NOT BE REPRODUCED OR CONVEYED IN ANY MANNER TO ANY THIRD PARTY. THIS DRAWING IS NOT TO BE USED ON ANY OTHER PROJECTS UNLESS SPECIFICALLY INDICATED HEREIN WITHOUT WRITTEN PERMISSION FROM AND DUE COMPENSATION TO AARON'S. PRIOR TO CONSTRUCTION IT MAY BE REQUIRED TO HAVE A SET OF PROFESSIONAL SEALED DRAWINGS MADE FOR PERMITS.

Aaron's
SALES & LEASE OWNERSHIP For Less!
 309 East Paces Ferry Road
 Atlanta, Georgia 30305
 Phone Number: (678) 402-3000

STORE NO.	F345
STORE LOCATION:	PORTLAND ME
DRAWING NO.	D3
DATE:	01/23/03
DRAWN BY:	C.S.G.
CHECKED BY:	
REVISIONS	
NUMBER	DESCRIPTION

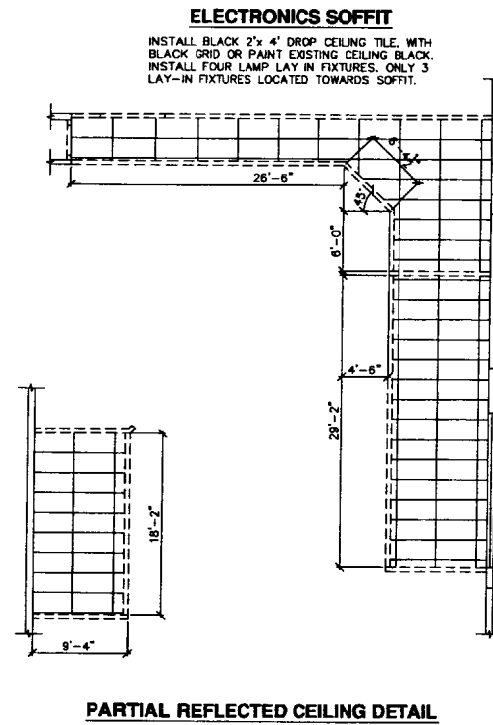
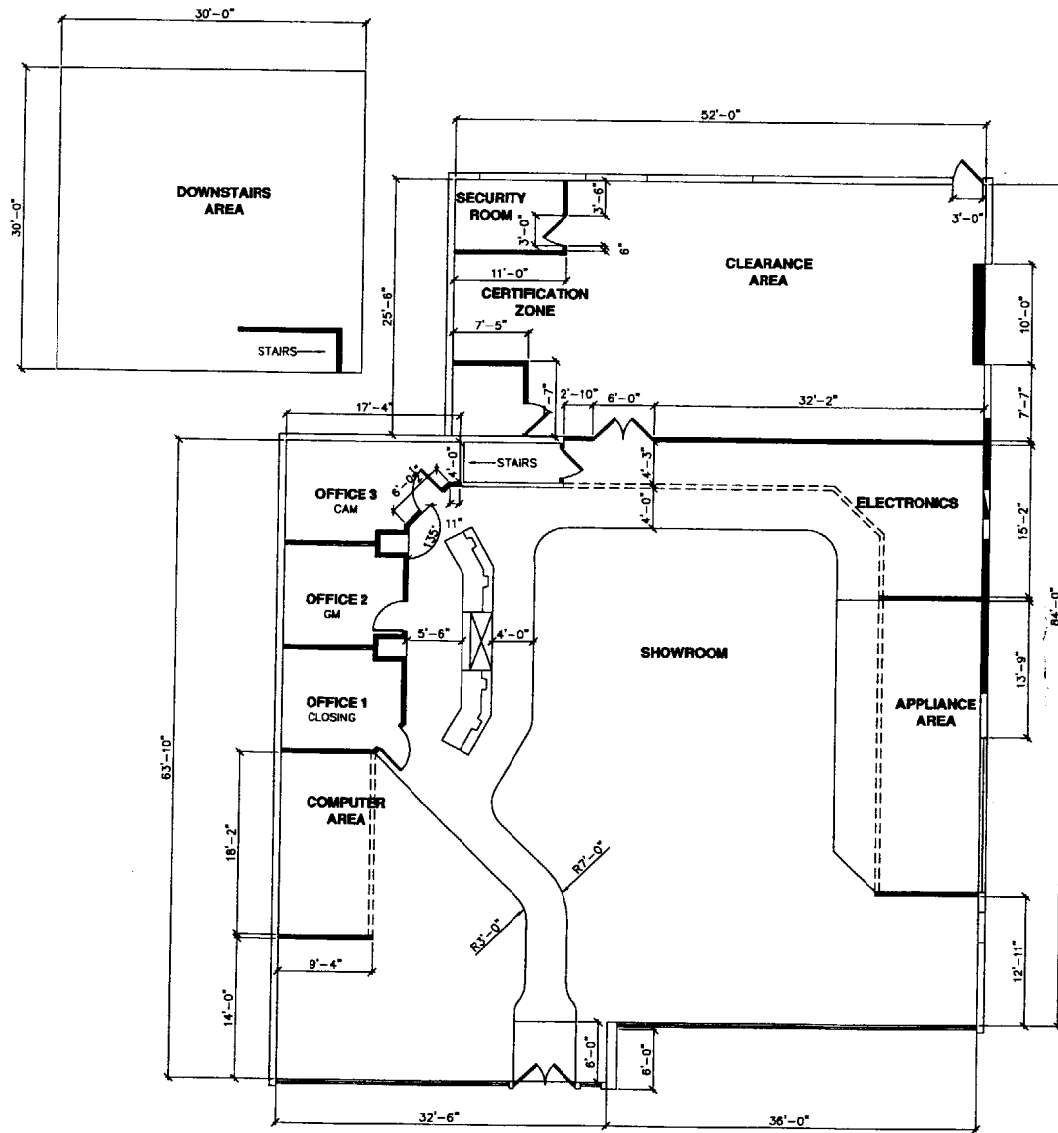

DIMENSION PLAN

THESE DRAWINGS ARE PROVIDED FOR INFORMATIONAL PURPOSES ONLY. AARON'S DOES NOT WARRANT OR REPRESENT THAT THE MATERIAL IS UP-TO-DATE OR COMPLIANT WITH ANY APPLICABLE LOCAL, STATE OR FEDERAL LAWS. REMEMBER, IT IS ULTIMATELY YOUR RESPONSIBILITY, AS A LICENSED FRANCHISEE, TO CONDUCT YOUR BUSINESS IN COMPLIANCE WITH ALL LAWS AND REGULATIONS. WE ENCOURAGE YOU TO EMPLOY LOCAL COUNSEL TO DETERMINE YOUR COMPLIANCE WITH APPLICABLE LAWS AND REGULATIONS. THESE DRAWINGS AND ANY PERMITTED REPRODUCTIONS IN WHOLE OR IN PART ARE THE SOLE PROPERTY OF AARON'S. THEY SHALL NOT BE REPRODUCED OR CONVEYED IN ANY MANNER TO ANY THIRD PARTY. THIS DRAWING IS NOT TO BE USED ON ANY OTHER PROJECTS UNLESS SPECIFICALLY INDICATED HEREIN WITHOUT WRITTEN PERMISSION FROM AND DUE COMPENSATION TO AARON'S. PRIOR TO CONSTRUCTION IT MAY BE REQUIRED TO HAVE A SET OF PROFESSIONAL SEALED DRAWINGS MADE FOR PERMITS.

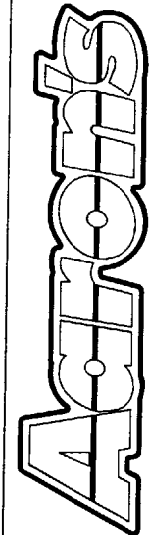

SALES & LEASE OWNERSHIP For Less!

309 East Paces Ferry Road
 Atlanta, Georgia 30305
 Phone Number: (678) 402-3000

STORE LOCATION:		PORTLAND ME		STORE NO:	F345
DRAWING NO:	D4	START DATE:	01/23/03	DRAWN BY:	C.S.G.
REVISIONS		DATE:			
NUMBER	DESCRIPTION				

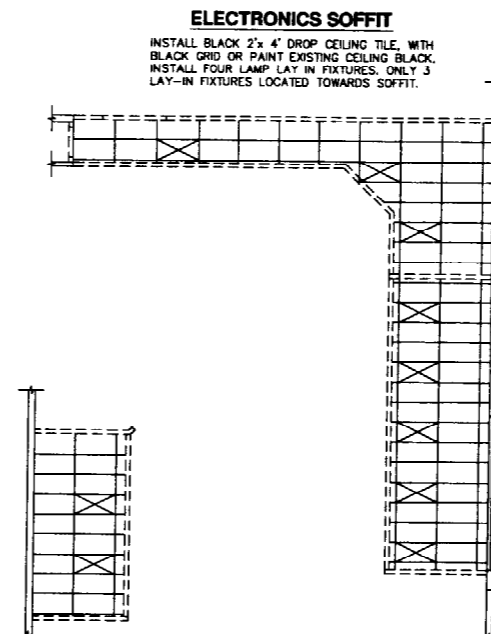
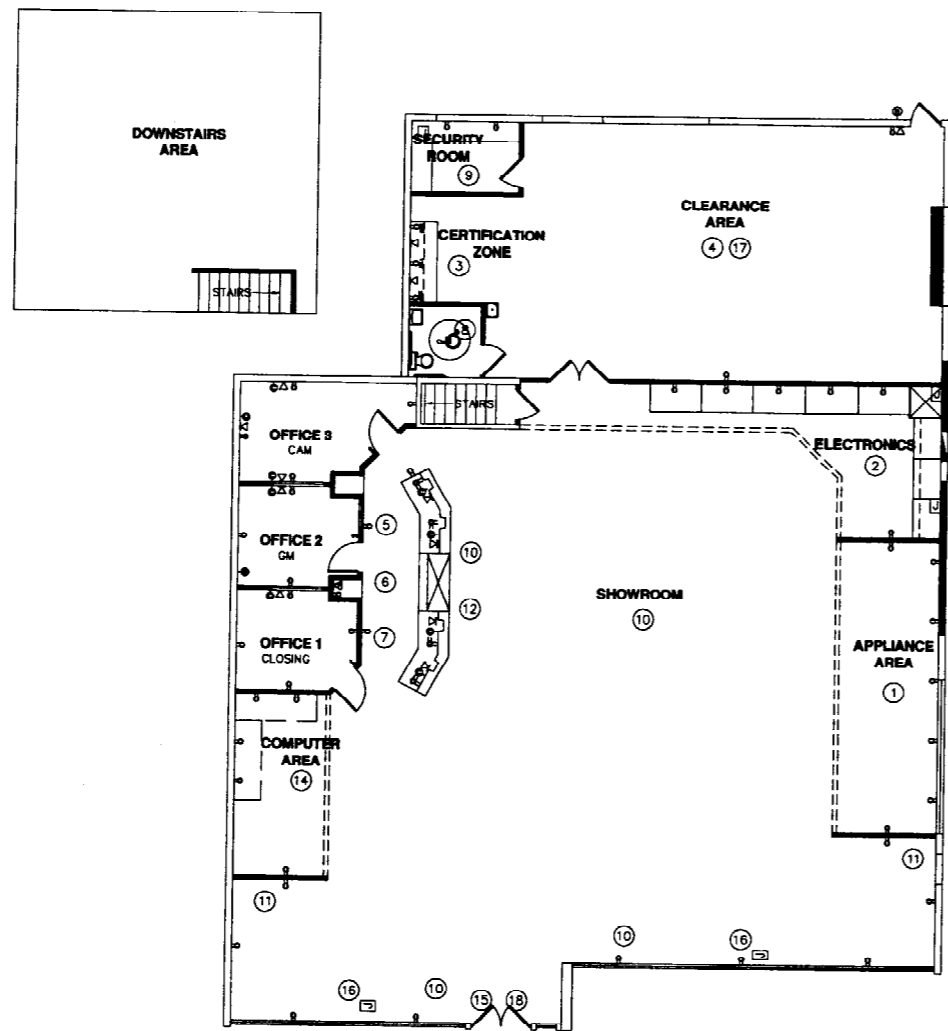

PARTIAL REFLECTED CEILING DETAIL
 N.T.S.
 CEILING GRID LAYOUT ARE FOR REPRESENTATION PURPOSES ONLY.

ELECTRICAL LEGEND

SYMBOLS	DESCRIPTION
[Symbol]	110V DUPLEX OUTLET
[Symbol]	QUADRUPLE OUTLET
[Symbol]	220V DUPLEX OUTLET
[Symbol]	110V JUNCTION BOX
[Symbol]	TELEPHONE OUTLET
[Symbol]	DOOR BELL
[Symbol]	FLUORESCENT LIGHT
[Symbol]	LIGHT SWITCH
[Symbol]	COMPUTER OUTLET
[Symbol]	TV OUTLET
[Symbol]	PHONE & DATA JACK
[Symbol]	MODEM JACK
[Symbol]	FAX JACK

LEGEND

SOFFIT	----
SOFFIT EXIST.	----
WALL INTERIOR	----
WALL INTERIOR EXIST.	----
WALL EXTERIOR	----

ELECTRICAL PLAN

THESE DRAWINGS ARE PROVIDED FOR INFORMATIONAL PURPOSES ONLY. AARON'S DOES NOT WARRANT OR REPRESENT THAT THE MATERIAL IS UP-TO-DATE OR CONFORMS TO ANY APPLICABLE LOCAL, STATE OR FEDERAL LAWS. REMEMBER, IT IS ULTIMATELY YOUR RESPONSIBILITY AS A LICENSED FRANCHISEE, TO CONDUCT YOUR BUSINESS IN COMPLIANCE WITH ALL LAWS AND REGULATIONS. WE ENCOURAGE YOU TO EMPLOY LOCAL COUNSEL TO DETERMINE YOUR CONFORMANCE WITH APPLICABLE LAWS AND REGULATIONS. THESE DRAWINGS AND ANY PERMITTED REPRODUCTIONS IN WHOLE OR IN PART ARE THE SOLE PROPERTY OF AARON'S. THEY SHALL NOT BE REPRODUCED OR CONVEYED IN ANY MANNER TO ANY THIRD PARTY. THIS DRAWING IS NOT TO BE USED ON ANY OTHER PROJECTS UNLESS SPECIFICALLY INDICATED HEREIN WITHOUT WRITTEN PERMISSION FROM AND DUE COMPENSATION TO AARON'S. PRIOR TO CONSTRUCTION IT MAY BE REQUIRED TO HAVE A SET OF PROFESSIONAL SEALED DRAWINGS MADE FOR PERMITS.

Aaron's
SALES & LEASE OWNERSHIP For Less!
 309 East Paces Ferry Road
 Atlanta, Georgia 30305
 Phone Number: (678) 402-3000

STORE LOCATION:	PORTLAND ME	STORE NO. F345
	DRAWING NO. D5	DRAFTED BY: C.S.G.
START DATE: 01/23/03	REVISIONS	DATE:
	DESCRIPTION	

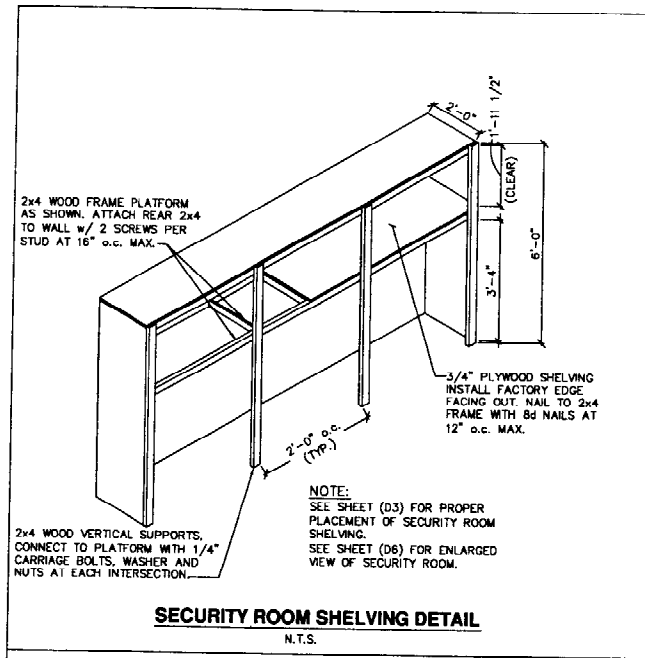

SECURITY ROOM SHELVING DETAIL
N.T.S.

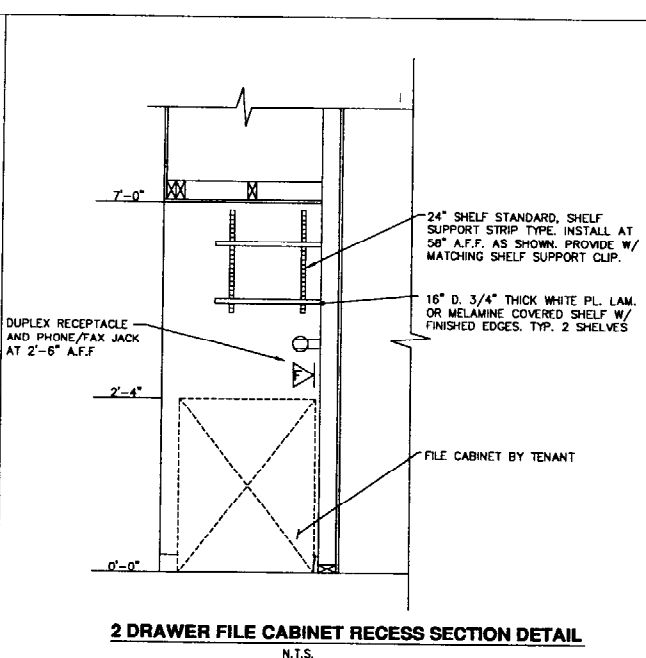

2 DRAWER FILE CABINET RECESS SECTION DETAIL
N.T.S.

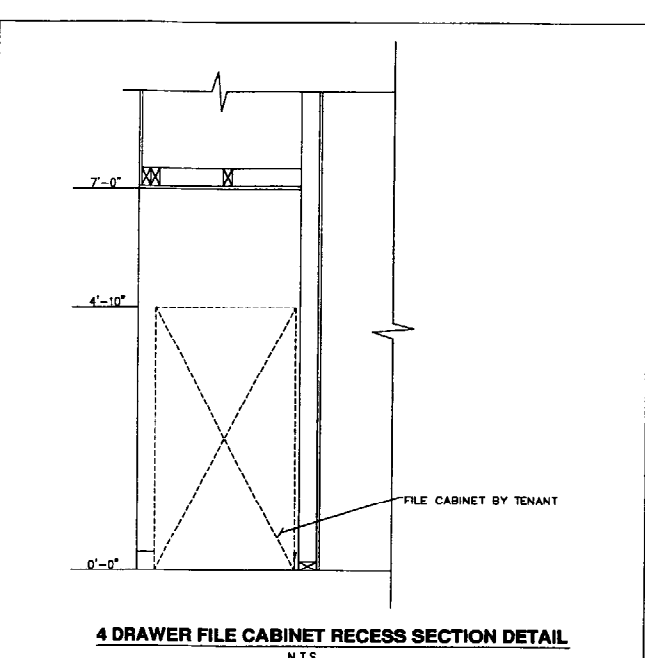

4 DRAWER FILE CABINET RECESS SECTION DETAIL
N.T.S.

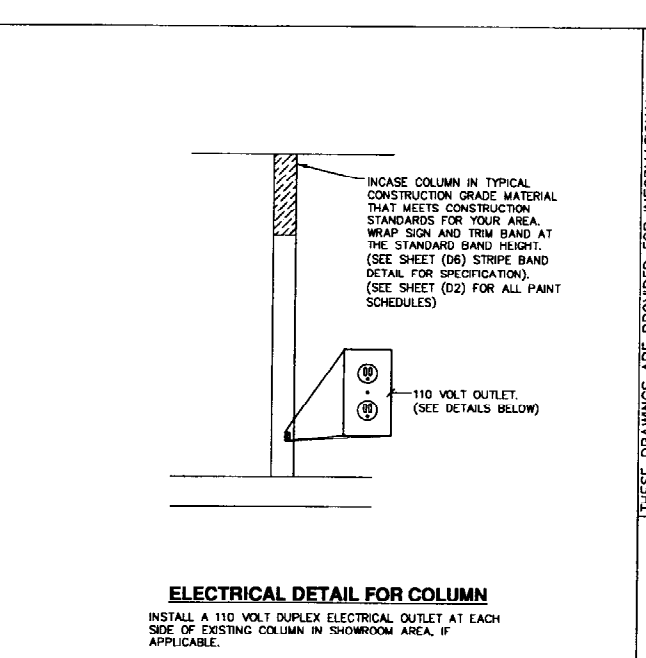

ELECTRICAL DETAIL FOR COLUMN
INSTALL A 110 VOLT DUPLEX ELECTRICAL OUTLET AT EACH SIDE OF EXISTING COLUMN IN SHOWROOM AREA, IF APPLICABLE.

THESE DRAWINGS ARE PROVIDED FOR INFORMATIONAL PURPOSES ONLY. AARON'S DOES NOT WARRANT OR REPRESENT THAT THE MATERIAL IS UP-TO-DATE OR CONFORMS TO ANY APPLICABLE LOCAL, STATE OR FEDERAL LAWS. REMEMBER, IT IS ULTIMATELY YOUR RESPONSIBILITY, AS A LICENSED FRANCHISEE, TO CONDUCT YOUR BUSINESS IN COMPLIANCE WITH ALL LAWS AND REGULATIONS. WE ENCOURAGE YOU TO EMPLOY LOCAL COUNSEL TO DETERMINE YOUR CONFORMANCE WITH APPLICABLE LAWS AND REGULATIONS. THESE DRAWINGS AND ANY PERMITTED REPRODUCTIONS IN WHOLE OR IN PART ARE THE SOLE PROPERTY OF AARON'S. THEY SHALL NOT BE REPRODUCED OR CONVEYED IN ANY MANNER TO ANY OTHER PARTY. THIS DRAWING IS NOT TO BE USED ON ANY OTHER PROJECTS UNLESS SPECIFICALLY INDICATED HEREIN WITHOUT WRITTEN PERMISSION FROM AND DUE COMPENSATION TO AARON'S. PRIOR TO CONSTRUCTION IT MAY BE REQUIRED TO HAVE A SET OF PROFESSIONAL SEALED DRAWINGS MADE FOR PERMITS.

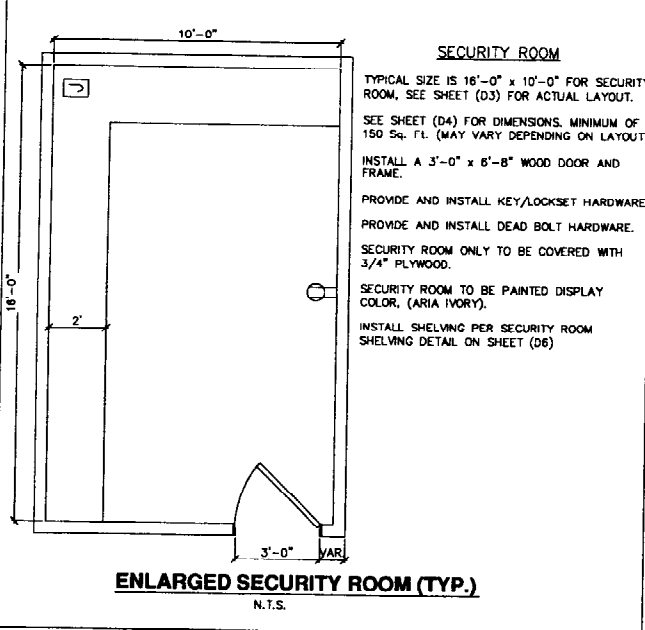

ENLARGED SECURITY ROOM (TYP.)
N.T.S.

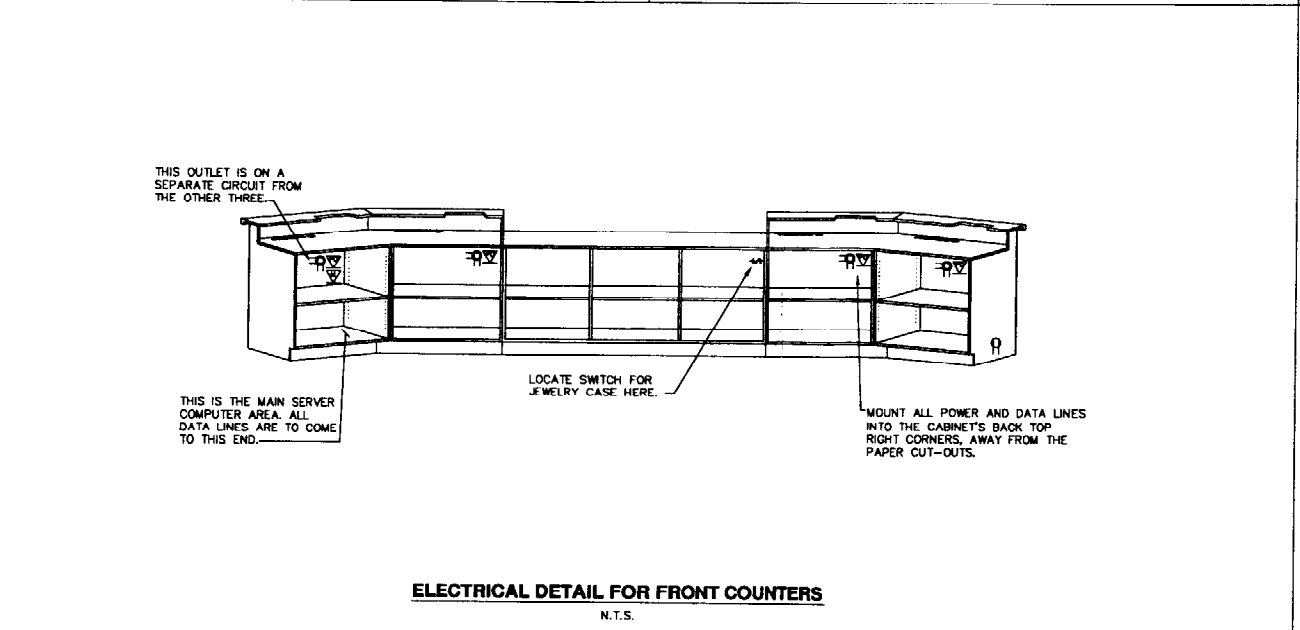

ELECTRICAL DETAIL FOR FRONT COUNTERS
N.T.S.

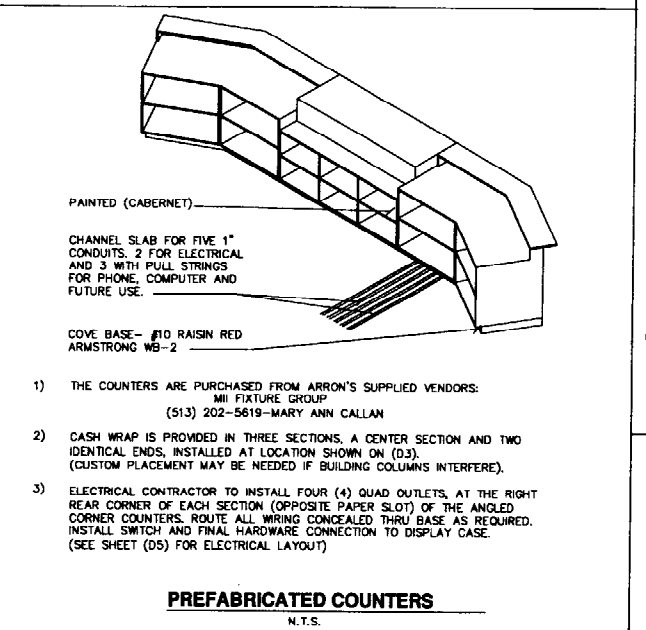

- 1) THE COUNTERS ARE PURCHASED FROM AARON'S SUPPLIED VENDORS:
MI FIXTURE GROUP
(513) 202-5619-MARY ANN CALLAN
- 2) CASH WRAP IS PROVIDED IN THREE SECTIONS, A CENTER SECTION AND TWO IDENTICAL ENDS, INSTALLED AT LOCATION SHOWN ON (D3). (CUSTOM PLACEMENT MAY BE NEEDED IF BUILDING COLUMNS INTERFERE).
- 3) ELECTRICAL CONTRACTOR TO INSTALL FOUR (4) QUAD OUTLETS, AT THE RIGHT REAR CORNER OF EACH SECTION (OPPOSITE PAPER SLOT) OF THE ANGLED CORNER COUNTERS. ROUTE ALL WIRING CONCEALED THRU BASE AS REQUIRED. INSTALL SWITCH AND FINAL HARDWARE CONNECTION TO DISPLAY CASE. (SEE SHEET (D5) FOR ELECTRICAL LAYOUT)

PREFABRICATED COUNTERS
N.T.S.

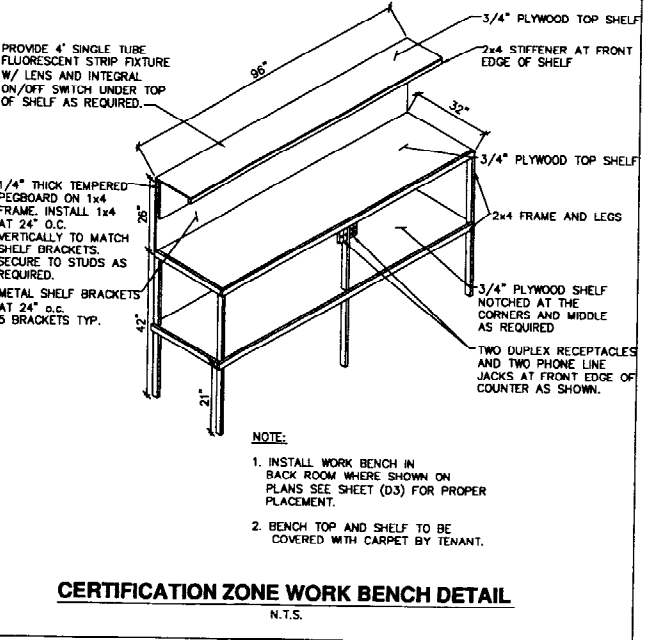

CERTIFICATION ZONE WORK BENCH DETAIL
N.T.S.

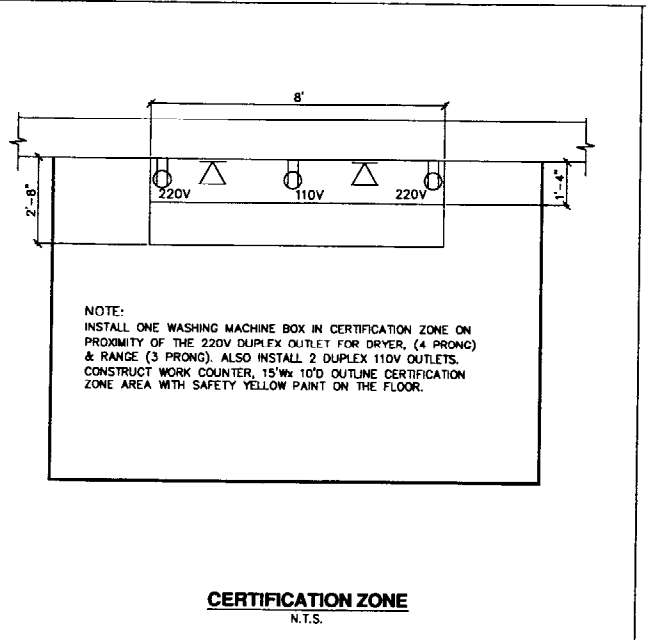

CERTIFICATION ZONE
N.T.S.

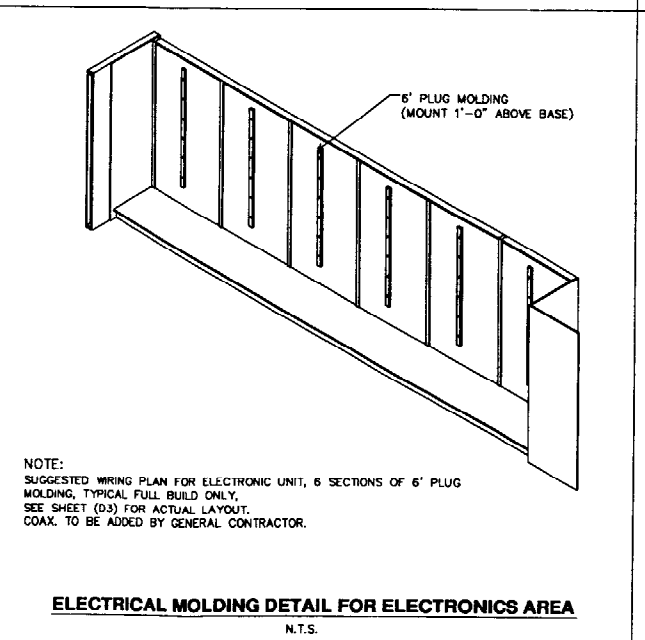

ELECTRICAL MOLDING DETAIL FOR ELECTRONICS AREA
N.T.S.

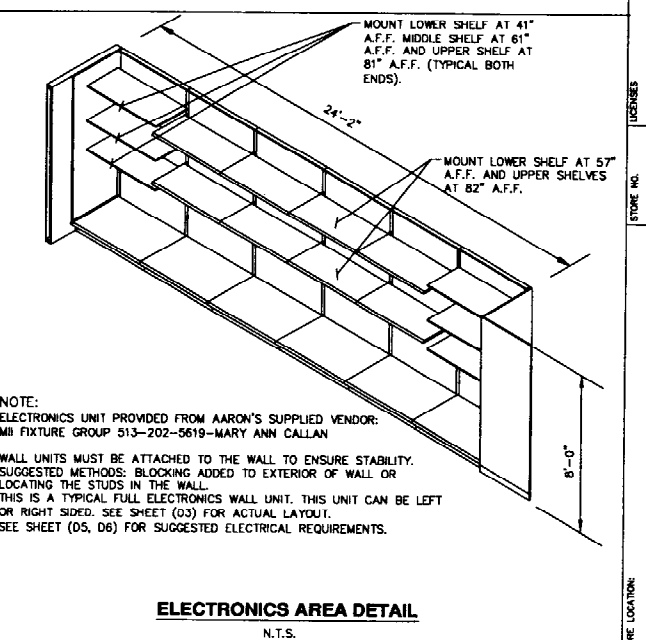

NOTE:
ELECTRONICS UNIT PROVIDED FROM AARON'S SUPPLIED VENDOR:
MI FIXTURE GROUP 513-202-5619-MARY ANN CALLAN

WALL UNITS MUST BE ATTACHED TO THE WALL TO ENSURE STABILITY. SUGGESTED METHODS: BLOCKING ADDED TO EXTERIOR OF WALL OR LOCATING THE STUDS IN THE WALL.

THIS IS A TYPICAL FULL ELECTRONICS WALL UNIT. THIS UNIT CAN BE LEFT OR RIGHT SIDED. SEE SHEET (D3) FOR ACTUAL LAYOUT.

SEE SHEET (D5, D6) FOR SUGGESTED ELECTRICAL REQUIREMENTS.

ELECTRONICS AREA DETAIL
N.T.S.

AARON'S

SALES & LEASE OWNERSHIP For Less!

309 East Paces Ferry Road
Atlanta, Georgia 30305
Phone Number: (678) 402-3000

STORE LOCATION:	PORTLAND ME
STORE NO.:	F345
DRAWING NO.:	D6
START DATE:	01/23/03
DRAWN BY:	C.S.G.
DATE:	
REVISIONS	
DESCRIPTION	
NUMBER	

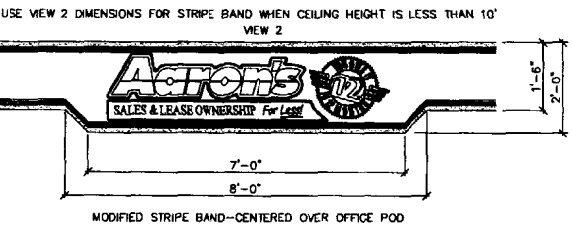
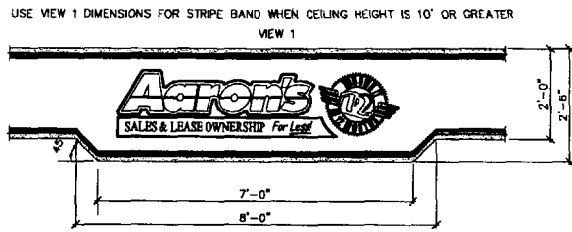

OFFICE STRIPE BAND DETAIL
N.T.S.

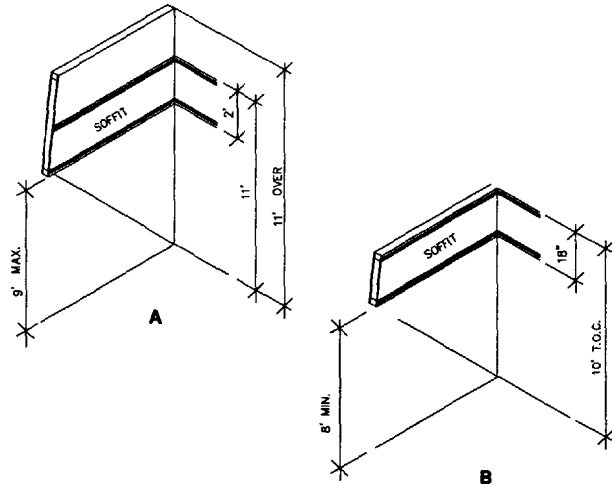

SOFFIT DETAILS
N.T.S.
NOTE:
SOFFIT A- MAX. SOFFIT HEIGHT IS 9' A.F.F. WHEN CEILING IS 11' OR GREATER.
SOFFIT B- MIN. SOFFIT HEIGHT IS 8' A.F.F. WHEN CEILING IS LESS THAN 10'.

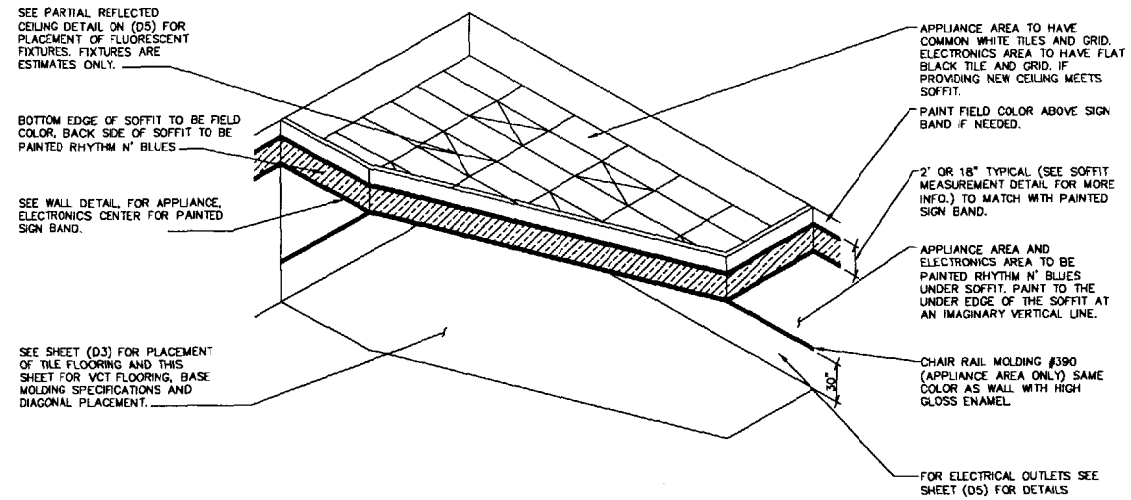

APPLIANCE, ELECTRONICS AND SOFFIT DETAIL (TYP.)
TYPICAL APPLIANCE AREA SHOWN, SEE (D3) FOR DIMENSIONS OF APPLIANCE AND ELECTRONICS AREA.

THESE DRAWINGS ARE PROVIDED FOR INFORMATIONAL PURPOSES ONLY. AARON'S DOES NOT WARRANT OR REPRESENT THAT THE MATERIAL IS UP-TO-DATE OR CONFORMS TO ANY APPLICABLE LOCAL, STATE OR FEDERAL LAWS. REMEMBER, IT IS ULTIMATELY YOUR RESPONSIBILITY, AS A LICENSED FRANCHISEE, TO CONDUCT YOUR BUSINESS IN COMPLIANCE WITH ALL LAWS AND REGULATIONS. WE ENCOURAGE YOU TO EMPLOY LOCAL COUNSEL TO DETERMINE YOUR COMPLIANCE WITH APPLICABLE LAWS AND REGULATIONS. THESE DRAWINGS AND ANY PERMITTED REPRODUCTIONS IN WHOLE OR IN PART ARE THE SOLE PROPERTY OF AARON'S. THEY SHALL NOT BE REPRODUCED OR CONVEYED IN ANY MANNER TO ANY OTHER PARTY. THIS DRAWING IS NOT TO BE USED ON ANY OTHER PROJECTS UNLESS SPECIFICALLY INDICATED HEREIN WITHOUT WRITTEN PERMISSION FROM AND DUE COMPENSATION TO AARON'S. PRIOR TO CONSTRUCTION, IT MAY BE REQUIRED TO HAVE A SET OF PROFESSIONAL SEALED DRAWINGS MADE FOR PERMITS.

SALES & LEASE OWNERSHIP For Less!

309 East Paces Ferry Road
Atlanta, Georgia 30305
Phone Number: (678) 402-3000

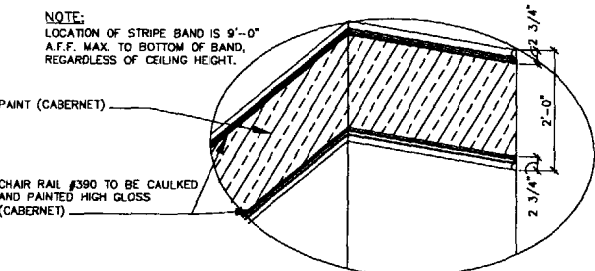

- 1) THE WALLS ARE TO BE PAINTED WITH A BAND THROUGH OUT THE STORE. TO INCLUDE STORE SHOWROOM WALLS, OFFICE OUTER WALL, SOFFITS, AND COLUMNS.
- 2) THE BAND IS TO HAVE PERIMETER MOLDING FRAMED IN IT, TO INCLUDE TWO 3/4" CHAIR RAIL MOLDING #390 CAULKED ON THE UNDERSIDE TO HIDE WALL DEFECTS.
- 3) IN THE APPLIANCE AREA ONLY-PAINT THE SCHEDULED APPLIANCE WALL DISPLAY COLOR FROM FLOOR TO BOTTOM OF THE SOFFIT. THE END OF THE DISPLAY COLOR SHOULD MATCH THE EDGES OF THE SOFFIT AND/OR TILED AREA'S.
- 4) WHEN PAINTING THE SIGN BAND, CONTINUE THE FIELD COLOR BELOW AND ABOVE THE PAINTED SIGN BAND WHERE APPLICABLE.
- 5) BAND TO BE PAINTED ONLY ON THE OUTSIDE OF HEADER FOR SOFFITS. DO NOT INSTALL BEHIND HEADER IN ELECTRONICS, APPLIANCE OR COMPUTER AREA.
- 6) FEATURE DISPLAY AREA TO BE PAINTED CABERNET FROM FLOOR TO BAND (WALL AND ADJACENT FACE OF WING WALL). SEE SHEET (D3) FOR LOCATION.

WALL DETAIL
N.T.S.

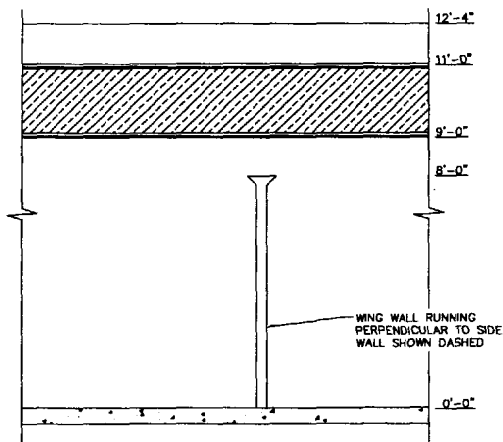

WING WALL FRONT ELEVATION
N.T.S.
(SHOWING TYPICAL WING WALL ELEVATION)

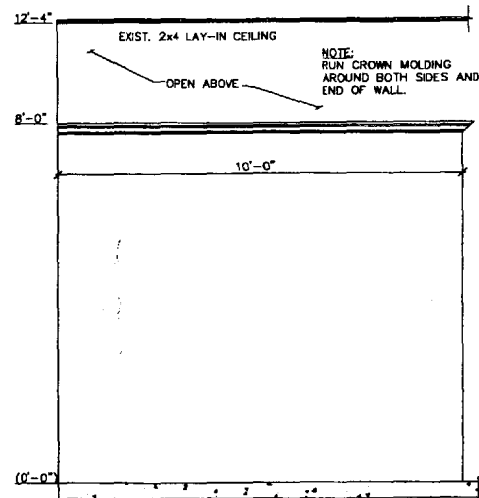

WING WALL SIDE ELEVATION
N.T.S.
(SHOWING TYPICAL ELEVATION OF WING WALL, ALSO SEE D3 FOR LOCATIONS)

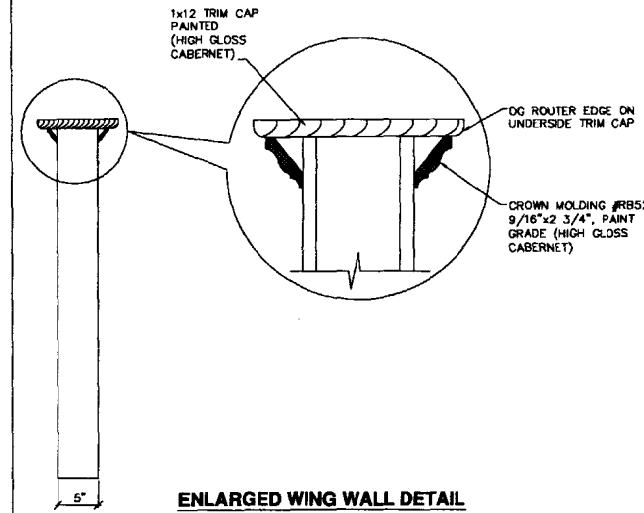

ENLARGED WING WALL DETAIL
WING WALL TO BE PAINTED DISPLAY COLOR. (ARIA IVORY) TRIM CAP AND MOLDING TO BE PAINTED SAME AS SIGN BAND MOLDING. (HIGH GLOSS CABERNET) FEATURE DISPLAY AREA SEE SHEET (D3), FOR PLACEMENT. SEE SHEET (D2), NOTE 17 ON FLOOR PLAN KEY NOTE FOR INFORMATION. IF CEILING IS LESS THAN 10' CONSULT: AARON'S REAL ESTATE & CONSTRUCTION DEPT.

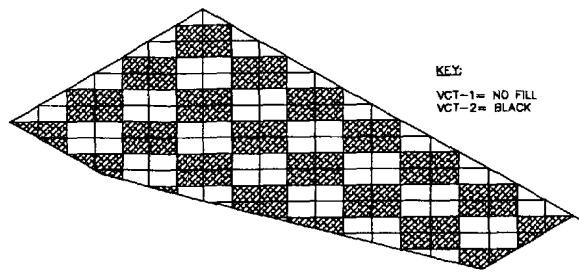

NOTE:
EXAMPLE OF TILE PLACEMENT IN APPLIANCE AREA.
VCT IS DIAGONALLY LAID AND MADE UP OF 2'x2' SQUARES. ENTRANCE AND BATHROOMS ARE SAME PATTERN, BUT 1'x1'. (SEE (D3) FOR PLACEMENT OF TILE FLOORING)

TILE FLOORING
N.T.S.

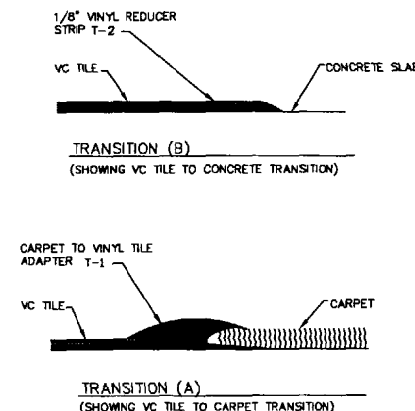

TRANSITION DETAILS
FULL SCALE

STORE NO.	F345
START DATE	01/23/03
DRAWING NO.	D7
STORE LOCATION	PORTLAND ME
DATE	01/23/03
DESIGNED BY	C.S.G.
REVISIONS	
NUMBER	DESCRIPTION

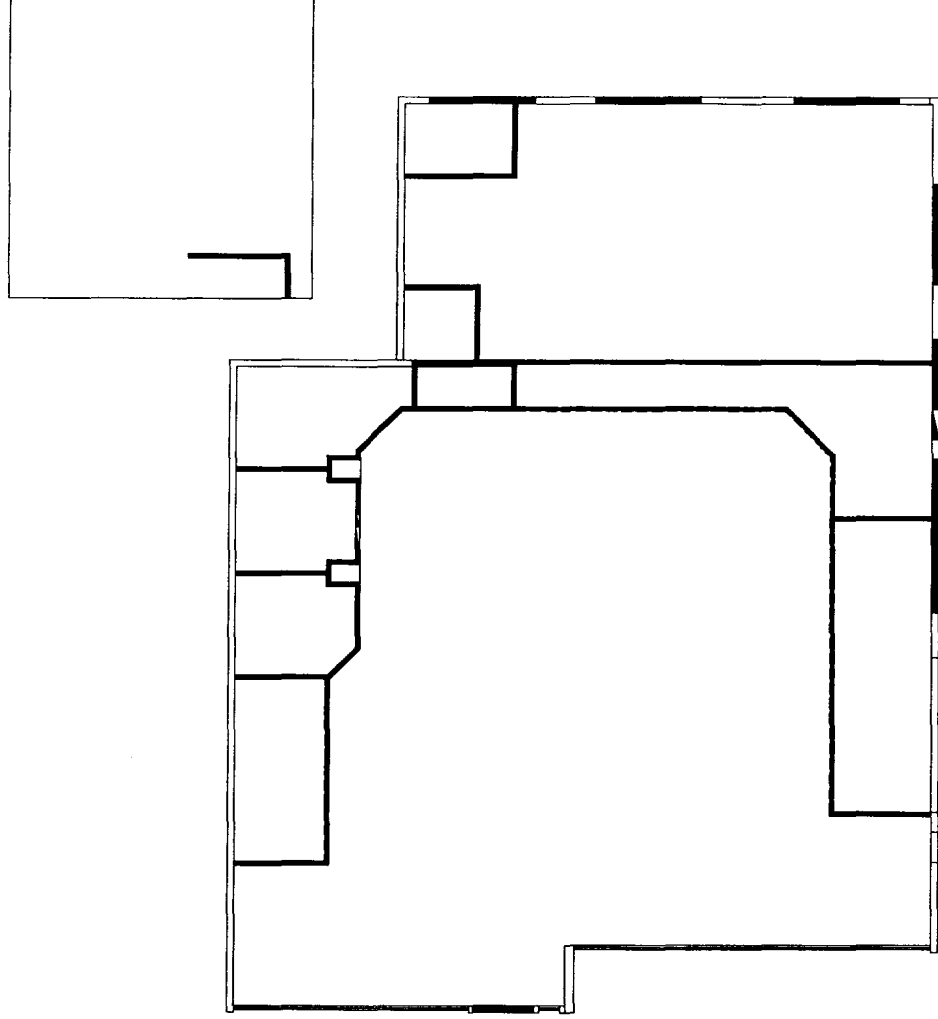

DEMOLITION PLAN

LEGEND

WALL INTERIOR	—————
EXIST. WALL INTERIOR	- - - - -
WALL EXTERIOR	=====
DEMOLITION	- - - - -

STORE NO.		F345	
DRAWING NO.		D9	
START DATE	01 / 23 / 03	DRAWN BY	C.S.G.
REVISIONS			
NUMBER	DESCRIPTION	DATE	

PORTLAND
ME

309 East Paces Ferry Road
Atlanta, Georgia 30305
Phone Number: (678) 402-3000

THESE DRAWINGS ARE PROVIDED FOR INFORMATIONAL PURPOSES ONLY. AARON'S DOES NOT WARRANT OR REPRESENT THAT THE MATERIAL IS UP-TO-DATE OR CONFORMS TO ANY APPLICABLE LOCAL, STATE OR FEDERAL LAWS. REMEMBER, IT IS ULTIMATELY YOUR RESPONSIBILITY AS A LICENSEE FRANCHISEE, TO CONDUCT YOUR BUSINESS IN COMPLIANCE WITH ALL LAWS AND REGULATIONS. WE ENCOURAGE YOU TO EMPLOY LOCAL COUNSEL TO DETERMINE YOUR CONFORMANCE WITH APPLICABLE LAWS AND REGULATIONS. THESE DRAWINGS AND ANY PERMITTED REPRODUCTIONS IN WHOLE OR IN PART ARE THE SOLE PROPERTY OF AARON'S. THEY SHALL NOT BE REPRODUCED OR CONVEYED IN ANY MANNER TO ANY THIRD PARTY. THIS DRAWING IS NOT TO BE USED ON ANY OTHER PROJECTS UNLESS SPECIFICALLY INDICATED HEREIN WITHOUT WRITTEN PERMISSION FROM AND DUE COMPENSATION TO AARON'S. PRIOR TO CONSTRUCTION IT MAY BE REQUIRED TO HAVE A SET OF PROFESSIONAL SEALED DRAWINGS MADE FOR PERMITS.



SALES & LEASE OWNERSHIP For Less!