

1 KITCHEN ELEVS.
A1.2 3/8" = 1'-0"

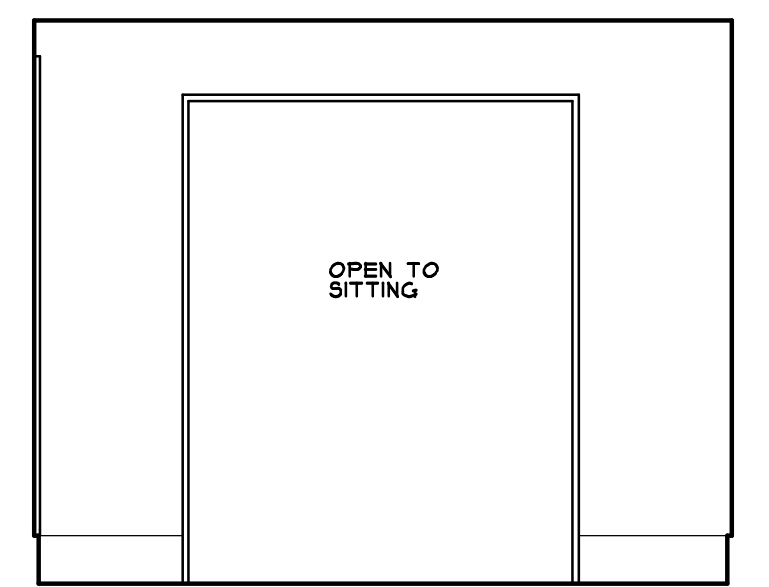

3 SUNROOM ELEVS.
A1.2 3/8" = 1'-0"

2 ISLAND ELEVS.
A1.2 3/8" = 1'-0"

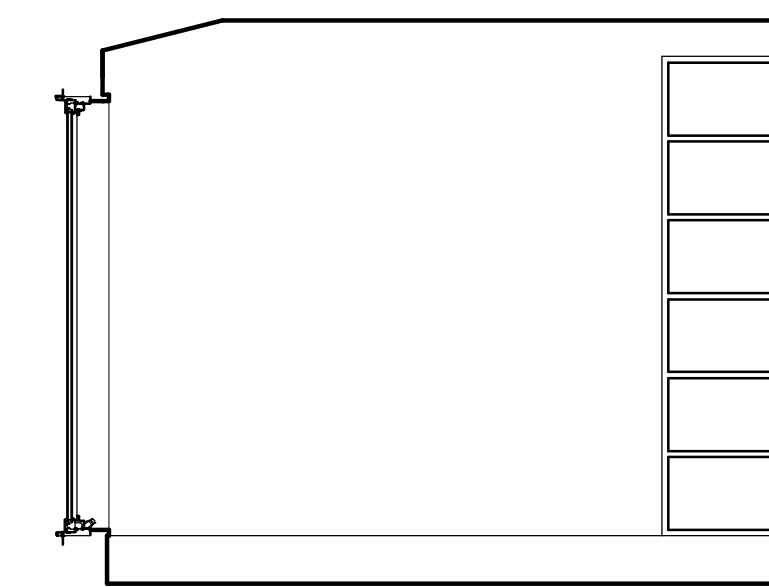
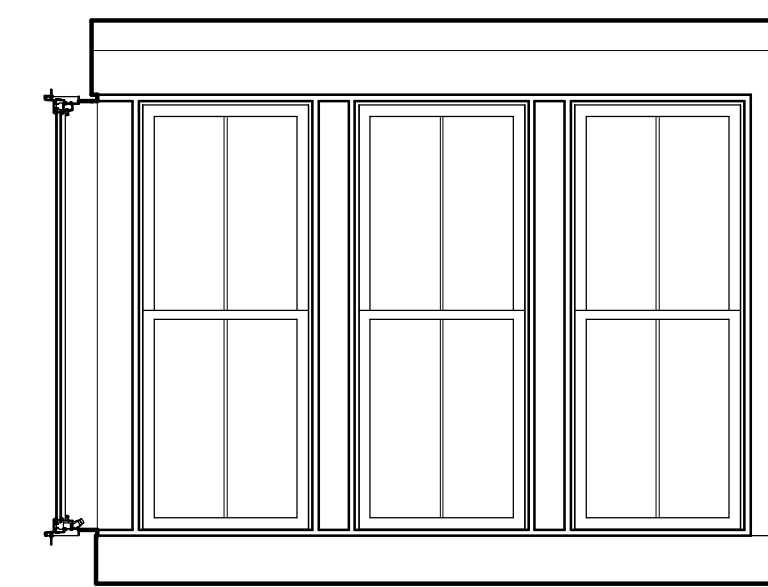
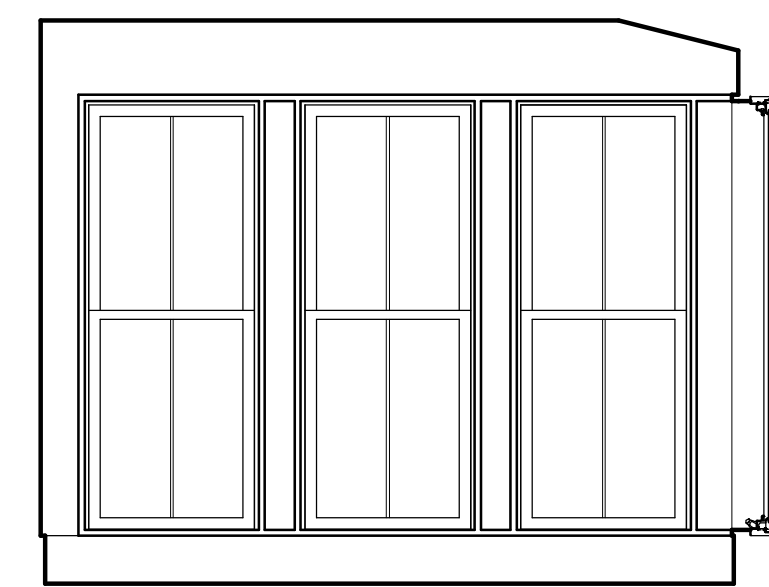
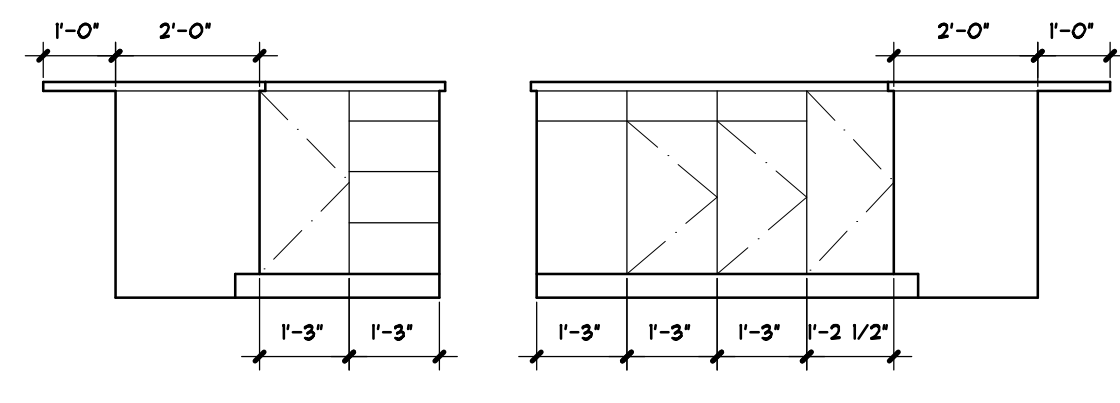
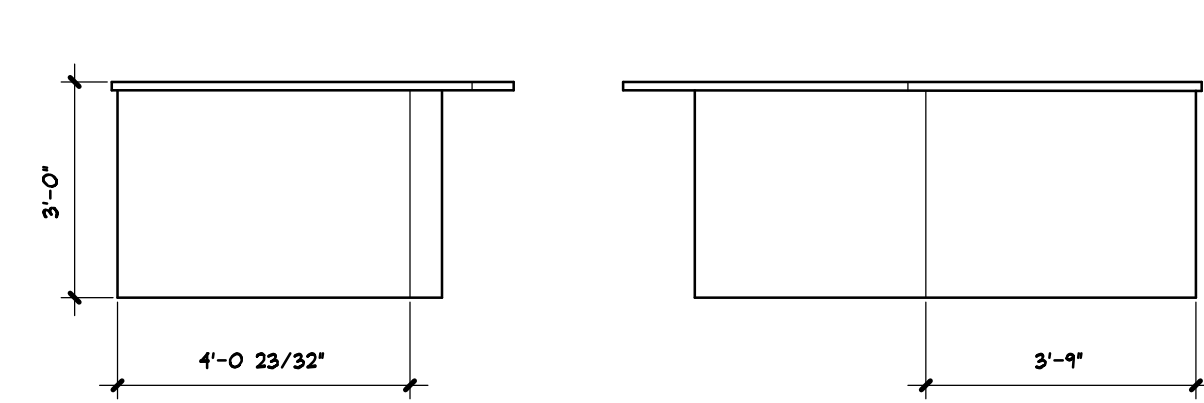
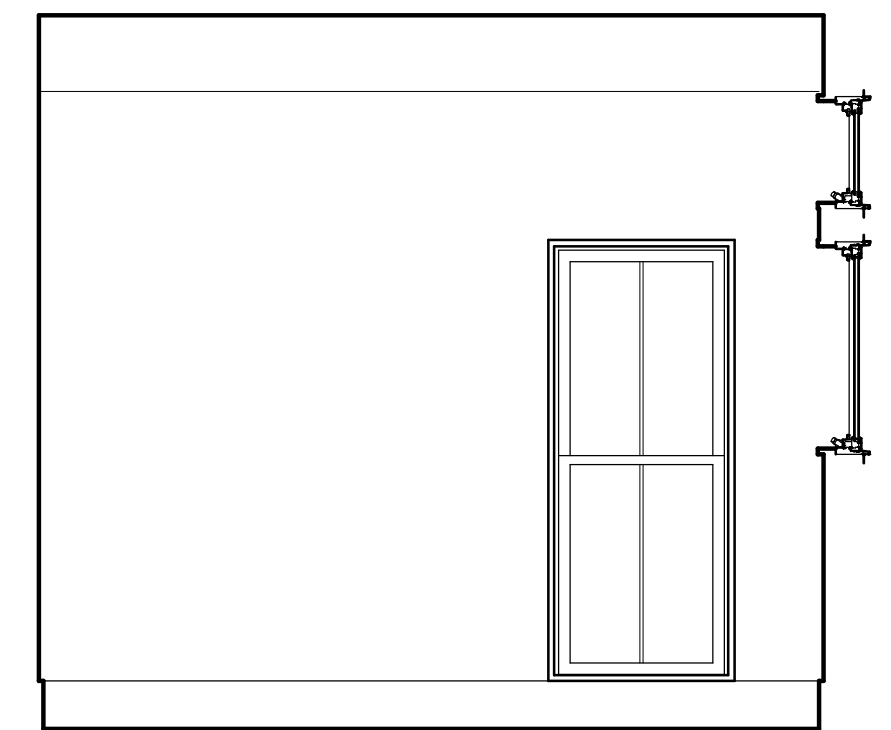
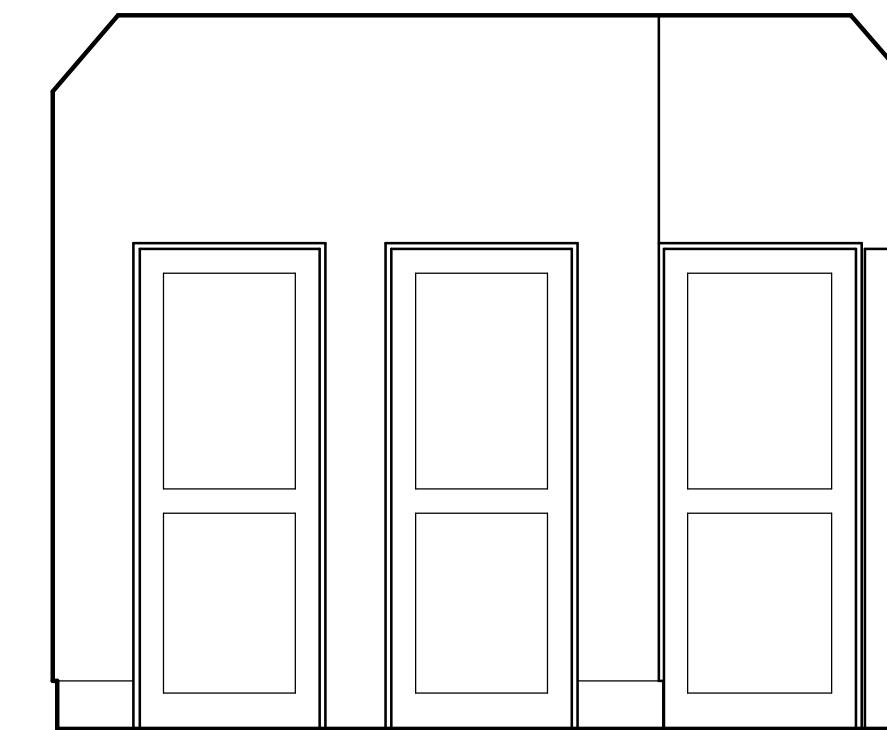
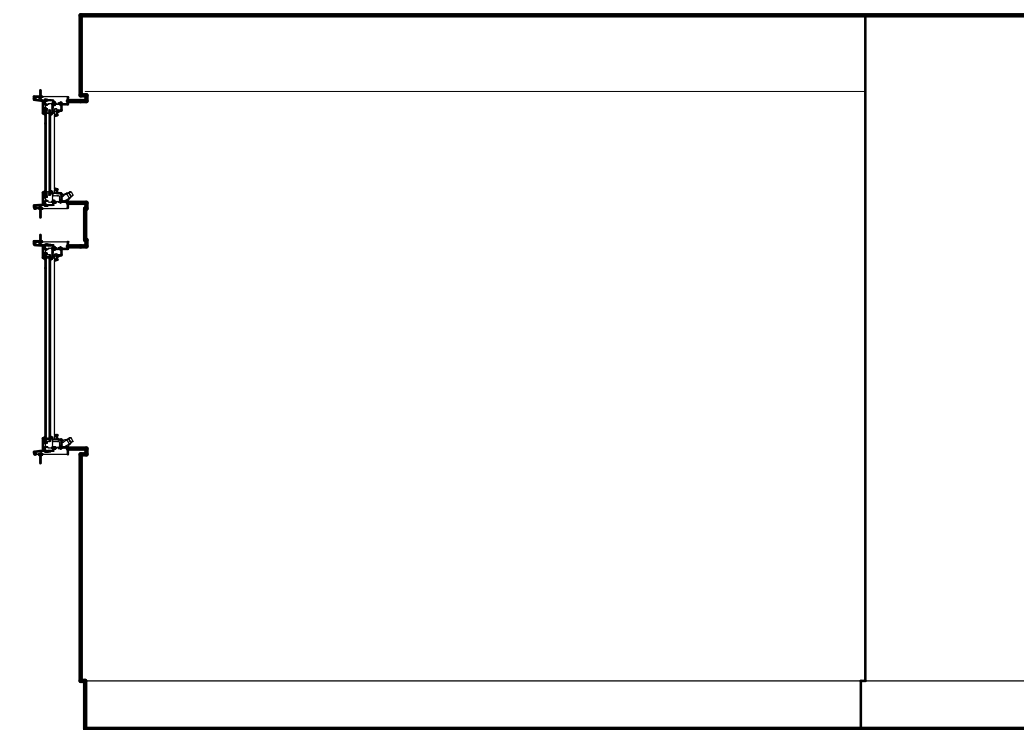
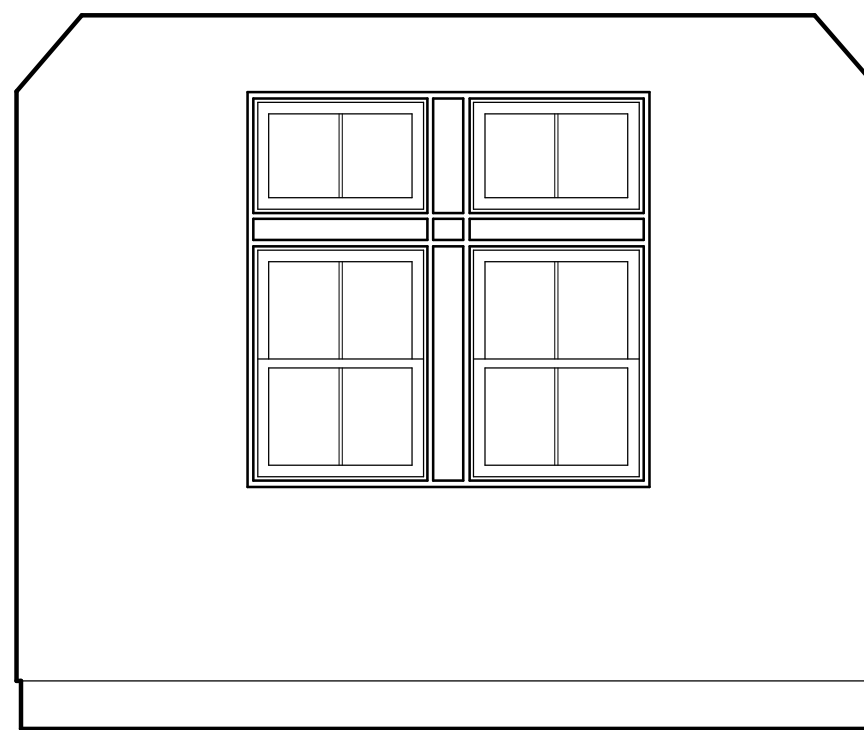
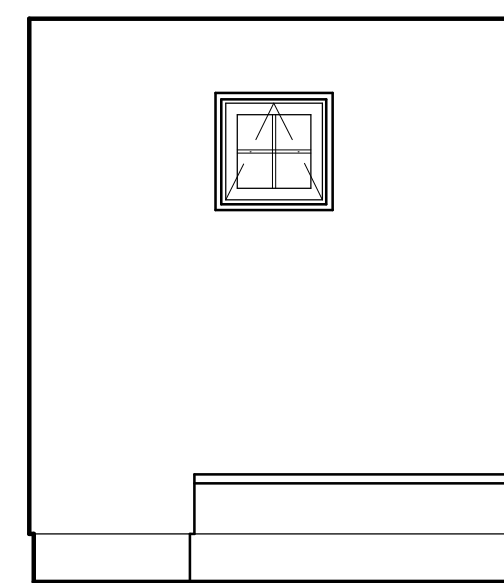
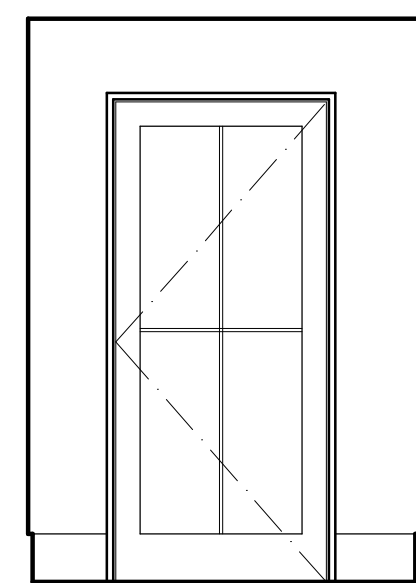
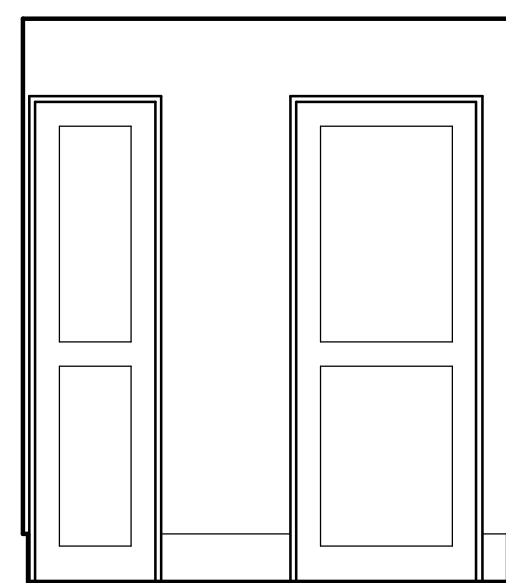
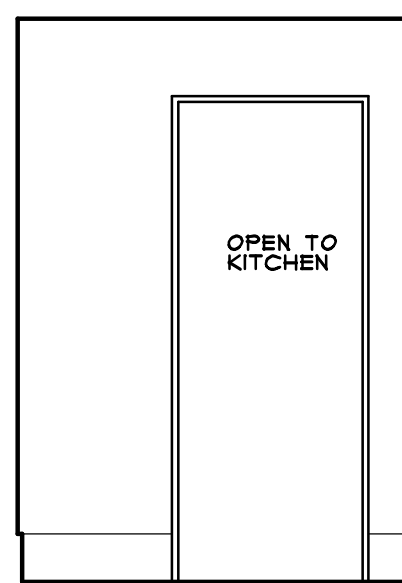

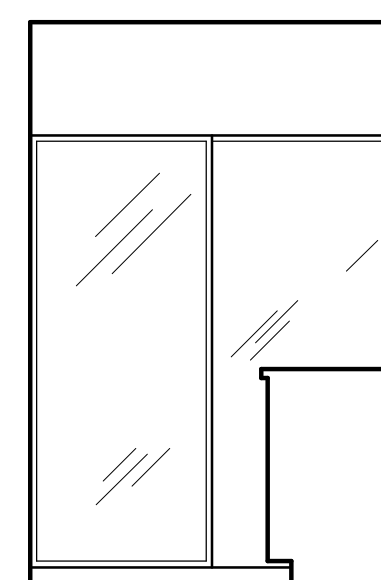
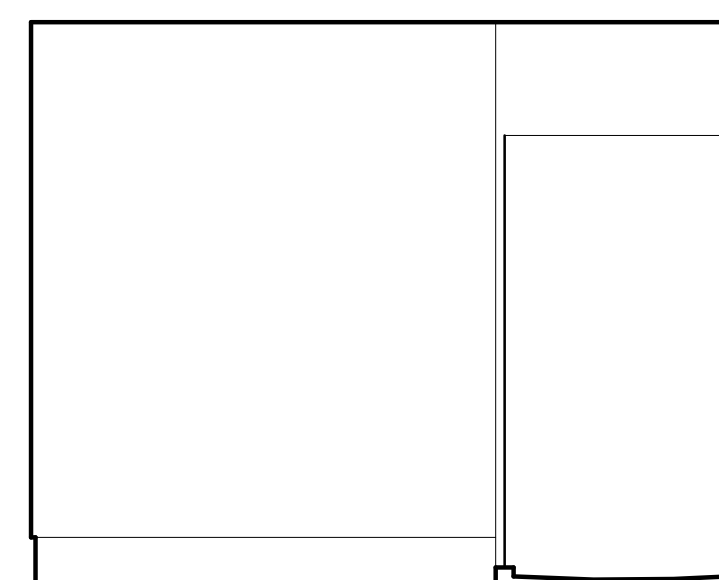
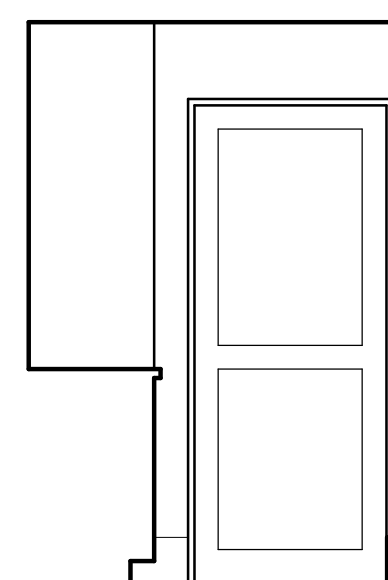
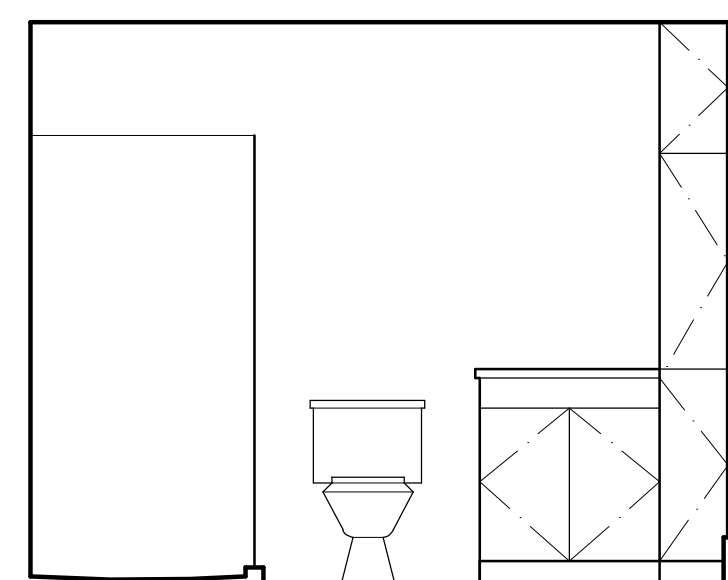

4 MUDROOM ELEVS.
A1.2 3/8" = 1'-0"

5 GUEST BEDROOM ELEVS.
A1.2 3/8" = 1'-0"

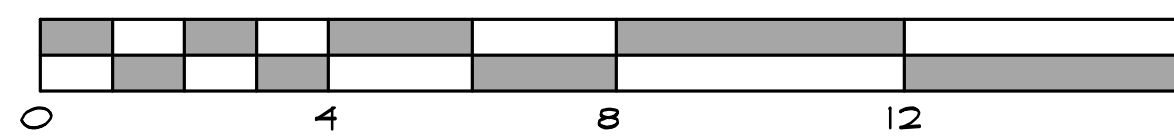

6 BATH ELEVS.
A1.2 3/8" = 1'-0"



PROJECT SMITH-HOOPES RESIDENCE		DATE 02.12.2013	<p>CONSTRUCTION SET</p>  <p>A1.2</p>
LOCATION 63 STROUDWATER RD. PORTLAND, ME		ISSUED FOR PRICING: XX.XX.XX	
		ISSUED FOR CONSTRUCTION: 05.28.2013	
		REV: XX.XX.XX	
		REV:	
		359 MAIN ST. 201-514-5551	ROCKLAND, ME 04841 WWW.HOUSESANDCOTTAGES.COM