

DISPLAY THIS CARD ON PRINCIPAL FRONTAGE OF WORK



CITY OF PORTLAND

BUILDING PERMIT

This is to certify that
NORRIS INC.
PO BOX 2551 - 2257 WEST BROADWAY
SOUTH PORTLAND, ME 04106

For installation at
1600 CONGRESS ST
NEPHROLOGY ASSOCIATES

Job ID: 2012-02-3340-FAFS

CBL: 220- B-010-001

has permission to install master box fire alarm system

provided that the person or persons, firm or corporation accepting this permit shall comply with all of the provisions of the Statutes of Maine and of the Ordinances of the City of Portland regulating the construction, maintenance and use of the buildings and structures, and of the application on file in the department.

Notification of inspection and written permission procured before this building or part thereof is lathed or otherwise closed-in. 48 HOUR NOTICE IS REQUIRED.

A final inspection must be completed by owner before this building or part thereof is occupied. If a certificate of occupancy is required, it must be

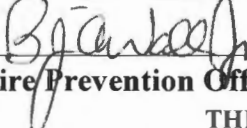
Fire Prevention Officer

58

Code Enforcement Officer / Plan Reviewer

THIS CARD MUST BE POSTED ON THE STREET SIDE OF THE PROPERTY
PENALTY FOR REMOVING THIS CARD

BUILDING PERMIT INSPECTION PROCEDURES

Please call 874-8703 or 874-8693 (ONLY)

or email: buildinginspections@portlandmaine.gov

With the issuance of this permit, the owner, builder or their designee is required to provide adequate notice to the city of Portland Inspections Services for the following inspections. Appointments must be requested 48 to 72 hours in advance of the required inspection. The inspection date will need to be confirmed by this office.

- **Please read the conditions of approval that is attached to this permit!! Contact this office if you have any questions.**
- **Permits expire in 6 months. If the project is not started or ceases for 6 months.**
- **If the inspection requirements are not followed as stated below additional fees may be incurred due to the issuance of a "Stop Work Order" and subsequent release to continue.**

Final Fire

The project cannot move to the next phase prior to the required inspection and approval to continue, REGARDLESS OF THE NOTICE OF CIRCUMSTANCES.

IF THE PERMIT REQUIRES A CERTIFICATE OF OCCUPANCY, IT MUST BE PAID FOR AND ISSUED TO THE OWNER OR DESIGNEE BEFORE THE SPACE MAY BE OCCUPIED.



PORTLAND MAINE

Strengthening a Remarkable City, Building a Community for Life • www.portlandmaine.gov

Director of Planning and Urban Development
Penny St. Louis

Job ID: 2012-02-3340-FAFS
install master box fire alarm system

For installation at:
1600 CONGRESS ST
NEPHROLOGY ASSOCIATES

CBL: 220- B-010-001

Conditions of Approval:

Fire

The fire alarm system shall comply with the City of Portland Standard for Signaling Systems for the Protection of Life and Property. All fire alarm installation and servicing companies shall have a Certificate of Fitness from the Fire Department.

In field installation shall be installed per code as conditions dictate.

All smoke detectors and smoke alarms shall be photoelectric.

Sprinkler supervision shall be provided in accordance with NFPA 101, *Life Safety Code*, and NFPA 72, *National Fire Alarm and Signaling Code*.

Records cabinet, FACP, annunciator(s), and pull stations shall be keyed alike.

Central Station monitoring for addressable fire alarm systems shall be by point.

All fire alarm records required by NFPA 72 should be stored in an approved cabinet located at the FACP labeled "FIRE ALARM RECORDS".

An approved existing Knox Box or a new 4100 series Knox Box is required.

The fire alarm system shall be certified by a master fire alarm company and have a new fire alarm inspection sticker.

System acceptance and commissioning must be coordinated with alarm and suppression system contractors and the Fire Department. Call 874-8703 to schedule.

Fire Alarm system shall be maintained. If system is to be off line over 4 hours a fire watch shall be in place. Dispatch notification required 874-8576.

Fire alarm system requires a wireless master box connection per city ordinance. Masterbox design and installation shall be as approved by City Electrical Division.

AES Zones shall be

1. Water Flow
2. City disconnect: Water flow
3. Pull stations & detectors
4. City Disconnect: Pull stations & detectors
5. Unassigned
6. Unassigned
7. Unassigned
8. AES Tamper switch

Master Box Approval

Applicant: Norris Inc.

Emergency Contact: Nephrology Assoc.

App Phone #: 207-883-1104 x 1104

Emergency phone #: 207-774-5222

Building Name: Nephrology Associates

Date of Application: 2/21/12

Building Address: 1600 Congress St

Billing Address: 1600 Congress St, STE B
Portland, ME 04102

Occupancy: Health Care

Comments:

Assembly OL>300, 20 unit apartment building, etc.

Applicant completes red box and submits with Fire Alarm Permit

1

FIRE PREVENTION: Approved

Denied

3 / 21 / 12

Date

B. J. W. [Signature]
Fire Prevention Officer

Zone 1: Water flow

Zone 2: City disconnect - Water Flow

Zone 3: Pulls and detectors

Zone 4: City disconnect - Pulls and Detectors

Zone 5: Unassigned

Zone 6: Unassigned

Zone 7: Unassigned

Zone 8: AES Tamper switch

Modify City Box response to alarm sounding in CAD: YES NO

2

FIRE ALARM: Box #: _____ (discontinue existing supervised box number)
1279

ELECTRICAL DIVISION: Approved Denied

Box Type: AES Radio Box / _____
New Other

3

Test Date: ____ / ____ / ____ In Service Date: ____ / ____ / ____

Fire Alarm Technician

AES

Circuit if applicable: _____

4

FIRE ALARM: Same Running Assignment As Box: _____

Notifications: All Stations Run Books Digitizer Computer Cad Box Test

South Portland _____
Other Dispatcher

5

BILLING: Entered _____
Financial Officer

City of Portland, Maine - Building or Use Permit Application

389 Congress Street, 04101 Tel: (207) 874-8703, FAX: (207) 8716

Job No: 2012-02-3340-FAFS	Date Applied: 2/22/2012	CBL: 220- B-010-001	
Location of Construction: 1600 CONGRESS ST	Owner Name: 164 REALTY INC.	Owner Address: 100 SILVER ST PORTLAND, ME 04101	Phone:
Business Name:	Contractor Name: SEABEE ELECTRIC	Contractor Address: 84 PLEASANT HILL RD, SCARBOROUGH, ME 04074	Phone: 883-5448
Lessee/Buyer's Name:	Phone:	Permit Type: FIRE ALARM	Zone: R-P
Past Use: Professional Offices & Dialysis Services	Proposed Use: Same: Professional Offices & Dialysis Services – to install Fire Alarm	Cost of Work: \$18,000.00	CEO District:
		Fire Dept: <input checked="" type="checkbox"/> Approved w/ conditions <input type="checkbox"/> Denied <input type="checkbox"/> N/A	Inspection: Use Group: Type:
		Signature: <i>[Signature]</i> (58)	Signature:
Proposed Project Description: New Fire Alarm permit		Pedestrian Activities District (P.A.D.)	
Permit Taken By: Brad		Zoning Approval	

<p>1. This permit application does not preclude the Applicant(s) from meeting applicable State and Federal Rules.</p> <p>2. Building Permits do not include plumbing, septic or electrical work.</p> <p>3. Building permits are void if work is not started within six (6) months of the date of issuance. False informatin may invalidate a building permit and stop all work.</p>	<p>Special Zone or Reviews</p> <p><input type="checkbox"/> Shoreland</p> <p><input type="checkbox"/> Wetlands</p> <p><input type="checkbox"/> Flood Zone</p> <p><input type="checkbox"/> Subdivision</p> <p><input type="checkbox"/> Site Plan</p> <p>___ Maj ___ Min ___ MM</p> <p>Date: <i>OK - [Signature]</i> 2/23/12</p>	<p>Zoning Appeal</p> <p><input type="checkbox"/> Variance</p> <p><input type="checkbox"/> Miscellaneous</p> <p><input type="checkbox"/> Conditional Use</p> <p><input type="checkbox"/> Interpretation</p> <p><input type="checkbox"/> Approved</p> <p><input type="checkbox"/> Denied</p> <p>Date:</p>	<p>Historic Preservation</p> <p><input checked="" type="checkbox"/> Not in Dist or Landmark</p> <p><input type="checkbox"/> Does not Require Review</p> <p><input type="checkbox"/> Requires Review</p> <p><input type="checkbox"/> Approved</p> <p><input type="checkbox"/> Approved w/Conditions</p> <p><input type="checkbox"/> Denied</p> <p>Date: <i>[Signature]</i></p>
	CERTIFICATION		

I hereby certify that I am the owner of record of the named property, or that the proposed work is authorized by the owner of record and that I have been authorized by the owner to make this application as his authorized agent and I agree to conform to all applicable laws of this jurisdiction. In addition, if a permit for work described in the appication is issued, I certify that the code official's authorized representative shall have the authority to enter all areas covered by such permit at any reasonable hour to enforce the provision of the code(s) applicable to such permit.

SIGNATURE OF APPLICANT	ADDRESS	DATE	PHONE
RESPONSIBLE PERSON IN CHARGE OF WORK, TITLE		DATE	PHONE



Fire Alarm Permit

Entered 2/21/12

ID#: 2012-02-3340 FAFS
201241094

If you or the property owner owes real estate or property taxes or user charges on any property within the city, payment arrangements must be made before permits of any kind are accepted.

R-P

Installation address: 1600 Congress St. CBL: 220 B010

Exact location: (within structure) _____

Type of occupancy(s) (NFPA & ICC): Professional offices/Dialysis Service

Building owner: Commercial Properties

System Designer (point of contact): Norris Inc. Melissa Peters

Designer phone: 207-883-3473 x1104 E-mail: melissap@norrisinc.com

Installing contractor: Seabee Electric Certificate of Fitness No: M1008

Contractor phone: 207-883-5448 E-mail: georgeb@seabeeelectric.com

This is a new application: YES NO New AES Master Box: YES NO
(Include Master Box approval form)

Amendment to an existing permit: YES NO Permit no: _____

The following documents shall be provided with this application:

- Floor plans
- Wiring diagram
- Annunciator details N/A
- Input/ Output Matrix
- Equipment data sheets
- Electrical Permit Pulled (check alarm/com)
- Scope of Work
- 11 1/2 x 17s
- pdf copy (may be e-mailed)
- Designer qualifications
- Battery/ voltage drop calcs

COST OF WORK: 18,000.00

PERMIT FEE: \$ 200.00
(\$10 PER \$1,000 + \$30 FOR THE FIRST \$1,000)

RECEIVED
FEB 21 2012
Dept. of Building Inspection

Master box approval only: YES NO
(If yes check *New AES Master Box* above)

The designer shall be the responsible party for this application. Download a new copy of this application at www.portlandmaine.gov/fire for every submittal. Submit all plans in electronic PDF in addition to readable 11 1/2 x 17s to the Building Inspections Department, 389 Congress Street, Room 315, Portland, Maine 04101.

Prior to acceptance of any fire alarm system, a complete commissioning and acceptance test must be coordinated with all fire system contractors and the Fire Department, and proper documentation of such test(s) provided.

All installation(s) must comply with the *City of Portland Technical Standard for Signaling Systems for the Protection of Life and Property*, available at www.portlandmaine.gov/fire.

Applicant signature: Melissa Peters Date: 2/21/12



PO Box 2551
2257 West Broadway
South Portland, ME 04106

1.800.370.3473
fax 207.879.0540

www.norrisinc.com

2/21/12

Scope of Work: Nephrology Associates:

Replace existing fire alarm panel with complete addressable fire alarm system including radio masterbox.
Provide (6) zone modules to connect existing zones to new panel.

Seabee Electric will install the equipment provided by Norris Inc. Norris Inc. will provide submittal documents, program and test per City of Portland requirements.



PO Box 2551
2257 West Broadway
South Portland, ME 04106

1.800.370.3473
fax 207.879.0540

www.norrisinc.com

SUBMITTAL PACKAGE

Project: Nephrology Associates

System: Fire Alarm Systems

**Submitted
By:** Norris Inc.
2257 West Broadway
South Portland, Maine 04106
Telephone: (800) 370-3473

**Electrical
Contractor:** Seabee Electric
84 Pleasant Hill Road
Scarborough, ME. 04106

Date: February 15, 2012



PO Box 2551
2257 West Broadway
South Portland, ME 04106

1.800.370.3473
fax 207.879.0540

www.norrisinc.com

Company Profile

"We are extremely proud to represent the highest quality manufacturers integrating life safety, alarm and communication systems throughout northern New England."

-- Bradford Norris, President --

Mission Statement

Provide quality engineered systems, exceptional service.

Goal

Learn...Continually Improve...Exceed Expectations

Founded in 1979 Norris Inc. has grown to become Northern New England's leading integrated system contracting and supply company. Norris Inc. is an innovated proactive organization with extensive experience in integration interdisciplinary building management systems. Our local and national affiliations assure that your project will be done properly regardless of size representing leading manufacturers our comprehensive products provide outstanding quality reliability and performance... surpassing customer application requirements and exceeding the stringent requirements of Underwriters Laboratories, National Fire Protection Association and other codes. We maintain an exceptional level of quality and provide the highest levels of customer service. Our knowledgeable technical support will insure the great service you deserve. Whether your needs involve industrial, commercial, institutional, or educational applications, you can trust that Norris Inc. has the complete resources it takes to provide the right solution right away.



PO Box 2551
2257 West Broadway
South Portland, ME 04106

1.800.370.3473
fax 207.879.0540

www.norrisinc.com

LIMITED WARRANTY

Norris, Inc. warrants that the products of its manufacturers shall be free from defects in materials or workmanship as warranted by the manufacturer which is typically for a one (1) year period from the completed installation date, but not always. The completed installation date will be the date when the end-user was able to begin using or started using the product(s) or the system, whether partially or in its entirety. For projects that have a specification or bid instructions to follow which contains specific warranty requirements, Norris Inc. will always honor the warranty terms exactly as specified in the project's specifications or bid documents, which may be more or less in coverage and duration than the manufacturer's warranty. In performing hundreds of projects per year with thousands of different products it is impossible for Norris, Inc. to track the terms and details of specified or individual product warranties. Therefore Norris, Inc. will request that the owner's representative provide these special warranty details when the warranty work is requested; otherwise a standard one year warranty on the equipment will be honored. The manufacturer's warranty is for equipment only and does not include any labor and/or shipping costs. All warranties provided by Norris, Inc. are limited with the same limitations included with the manufacturer's warranty which is included in the manuals of the products being provided.

The warranty will apply only if such goods have been properly installed, are subject to normal proper use and have not been modified in any manner whatsoever. Upon return of the defective product, Norris, Inc. will, at its sole discretion, either repair or replace, at no cost, such goods determined to have a defect in materials or workmanship. In cases of a warranty repair, Norris, Inc. will use its sole discretion to determine if a suitable replacement part can be provided on loan while the repairs are being performed.

All warranty work is performed during regular business hours. If emergency warranty work is required, the customer will pay the difference between the emergency service bill and our normal hourly charges.

Norris, Inc.'s limited warranty does not apply to those products that are damaged due to misuse, abuse, negligence, exposure to adverse environmental conditions, acts of God or have been modified in any manner whatsoever.

Norris, Inc.'s Standard terms and conditions are provided with our invoices. Those Terms and Conditions shall be provided upon request.

NORRIS, INC. SHALL NOT UNDER ANY CIRCUMSTANCES BE LIABLE FOR ANY INCIDENTAL OR CONSEQUENTIAL DAMAGES ARISING FROM LOSS OF LIFE &/OR PROPERTY OR OTHER DAMAGE OR LOSSES OWING TO THE FAILURE OF NORRIS INC. PRODUCTS BEYOND THE COST OF REPAIR OR REPLACEMENT OF ANY DEFECTIVE PRODUCTS.

NORRIS, INC. MAKES NO WARRANTY OF FITNESS OR MERCHANTABILITY AND NO OTHER WARRANTY, ORAL OR WRITTEN, EXPRESS OR IMPLIED AS ALLOWED TO THE FULLEST EXTENT OF THE LAW.



This is to certify that

NORRIS, INC.

is an authorized Engineered Systems Distributor for NOTIFIER

During the year of 2011

Jh Jomler

Signed for and on behalf of NOTIFIER

Vice President Domestic Sales

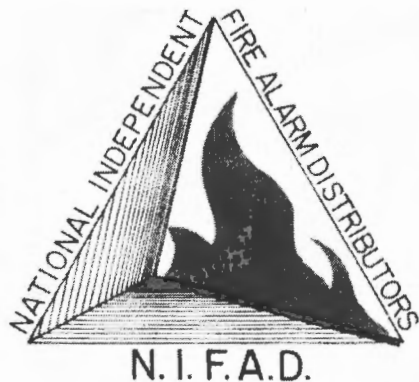

National Independent Fire Alarm Distributors Association

This is to Certify that

Norris Inc.

is a

Member in Good Standing

and is entitled to all rights and privileges of such membership

David Roemer

Secretary

Bob Smith

President



**NATIONAL INSTITUTE FOR CERTIFICATION
IN ENGINEERING TECHNOLOGIES®**

Providing Certification Programs Since 1961

BE IT KNOWN THAT

David S. Gagnon

IS HEREBY AWARDED CERTIFICATION AT

LEVEL IV

**IN FIRE PROTECTION ENGINEERING TECHNOLOGY
FIRE ALARM SYSTEMS**

BASED UPON SUCCESSFUL DEMONSTRATION OF REQUISITE KNOWLEDGE,
EXPERIENCE AND WORK PERFORMANCE AS SET FORTH BY THIS INSTITUTE.

Certification Valid through April 1, 2014

CERTIFICATION NUMBER 88203

CHAIRMAN OF THE NICET BOARD OF GOVERNORS

A DIVISION OF THE NATIONAL SOCIETY OF PROFESSIONAL ENGINEERS

Norris Inc

2257 West Broadway
 South Portland, ME 04106
 1-800-370-3473

SEABEE ELECTRIC

84 PLEASANT HILL RD
 SCARBOROUGH, ME 04074

311531SP**Equipment List :**

Page: 1

SEABEE 207-883-5448 Fax:883-1660

Nephrology Associates**Description**

NOTIFIER-NFW2-100, Addressable fire alarm control panel. Black
 ADI-IM-12120, 12 V 12AH Battery
 ADI-MO-804R2, MOD TO MOD 8C 2'RADIONICS CORD
 ADI-MO-RJ31X, SFS MT 8C RJ31X UL (917UL)
 NOTIFIER-4XTM, Plug-in Transmitter module
 NOTIFIER-NOT-BG12LX, Addressable Pull Station
 NOTIFIER-NP-100, Intelligent Addressable Photo detector, with base.
 NOTIFIER-DNR, InnovairFlex intelligent duct detector, non-relay, does not incl
 NOTIFIER-NP-100R, Intelligent Addressable Photo detector with remote test capabili
 NOTIFIER-RTS151, Remote test station; with switch, alarm and power LED#s.
 NOTIFIER-DST3, InnovairFlex sampling tube, steel, 3# with holes
 NOTIFIER-NC-100R, Addressable Relay Module (ducts)
 NOTIFIER-NMM-100P, Addressable Mini Module (sprinkler)
 NOTIFIER-FCPS-24S8, 8.0 amps, 120 VAC remote charger power supply
 ADI-IM-1270, 12V 7AH Battery
 NOTIFIER-HSR, Horn Strobe, Red, Wall, 2 wire, 12/24V, multi-candela
 NOTIFIER-STR, Strobe, Red, Wall, 2 wire, 12/24V, multi-candela
 NOTIFIER-NZM-100, Addressable 2-Wire Detector Zone Module (existing zones)
 NOTIFIER-BB-25, Cabinet, mounts up to six XP6 boards or ACPS-610
 NOTIFIER-CHS-6, Chassis, mounts up to 6 XP-6 modules in a BB-25
 AES-7750-F8 RED, 8 Zone Fire Subscriber, 8 Supervised Zones,
 ADI-IM-1270, 12V 7AH Battery
 ADI-AS-XF1640Y, Transformer 16VAC 40VA
 NOTIFIER-NC-100R, Addressable Relay Module (masterbox)
 NOTIFIER-NMM-100, Addressable Monitor Module (masterbox)
 ADI-GI-TSW01, Tamper Box w/ Shunt

FireWarden-100-2(E) Rev 3

Intelligent Addressable FACP with Built-In Communicator



Addressable Fire Alarm Control Panel

General

The Notifier FireWarden-100-2 Rev 3 (NFW2-100 Rev 3) with Version 5.0 firmware is a combination FACP (Fire Alarm Control Panel) and DACT (Digital Alarm Communicator/Transmitter) all on one circuit board. This compact intelligent addressable control panel has an extensive list of powerful features.

The SLC (Signaling Line Circuit) of the FireWarden-100-2 Rev 3 operates using a Rapid Group Polling communication protocol technology that polls multiple devices simultaneously for a quicker device response time. This patented technology allows a fully-loaded panel with up to 198 devices to report an incident and activate the notification circuits in under 10 seconds. With this improved polling, devices can be wired on standard twisted, unshielded wire up to a distance of 10,000 feet.

The FireWarden-100-2 Rev 3's quick-remove chassis protects the electronics during construction. The backbox can be installed allowing field wiring to be pulled. When construction is completed, the electronics can be quickly installed with just two bolts.

New features for Rev 3 with Version 5.0 firmware include removable terminal blocks, improved transient protection, additional secondary ANN-BUS, and increased power for the resettable and remote sync outputs.

Available accessories include ANN-BUS devices as well as ACS LED, graphic and LCD annunciators, and reverse polarity/city box transmitter.

The integral DACT transmits system status (alarms, supervisories, troubles, AC loss, etc.) to a Central Station via the public switched telephone network. It also allows remote and local programming of the control panel using the PS-Tools Upload/Download utility. In addition, the control panel may be programmed or interrogated off-site via the public switched telephone network. Any personal computer with Windows® XP or greater, a compatible modem, and PS-Tools, the Upload/Download software kit, may serve as a Service Terminal. This allows download of the entire program or upload of the entire program, history file, walktest data, current status and system voltages. The panel can also be programmed through the FACP's keypad or via a standard PS-2 computer keyboard, which can be plugged directly into the printed circuit board. This permits easy typing of address labels and other programming information.

Version 5.0 firmware supports the following: Primary and Secondary ANN-bus devices, NP-A100, USB port, NAC circuit diagnostics, a new report has been added to the walk-test that lists untested devices, new device types added: audio telephone type code for NFV-25/50ZST, Photo Supervisory and auto-resettable Drill (non-latching).

The FireWatch Series internet monitoring modules IPDACT-2 and IPDACT-2UD permit monitoring of alarm signals over the Internet saving the monthly cost of two dedicated business telephone lines. Although not required, the secondary telephone line may be retained providing backup communication over the public switched telephone line.

NOTE: Unless otherwise specified, the term "FireWarden-100-2" is used in this document to refer to both the FireWarden-100-2 and the FireWarden-100-2E FACP's (Fire Alarm Control Panels). Likewise, "NFW2-100" refers to NFW2-100E as well.



Features

- Listed to UL standard 864, 9th edition.
- On-board DACT.
- Remote site or local USB port upload/download, using PS-Tools.
- Four (4) Style Y (Class B) NAC circuits, which can be converted to four (4) Style Z (Class A) circuits with optional ZNAC-92 converter module. (Up to 6.0 amps total NAC power when using optional XRM-24B.)
- Selectable strobe synchronization for System Sensor, Wheelock, and Gentex devices.
- Remote Acknowledge, Silence, Reset and Drill via addressable monitor modules or FDU-80, N-ANN-80 or Legacy ACS Annunciators.
- ANN-BUS for connection to following optional modules (cannot be used if ACS annunciators are used):
 - N-ANN-80(-W) Remote LCD Annunciator
 - N-ANN-I/O LED Driver
 - N-ANN-S/PG Printer Module
 - N-ANN-RLY Relay Module
 - N-ANN-LED Annunciator Module
 - N-ANN-RLED Annunciator Module alarms only
 - ROME Relay Option Module Enclosure
- ACS & Terminal-mode Annunciators:
 - ACS Annunciators: Up to 32 Legacy ACM Series annunciators (ACM-16AT or ACM-32 series). Cannot be used if ANN-BUS devices are used.
 - Terminal-mode Annunciators: Up to 32 Legacy FDU-80 annunciators.
- EIA-232 printer/PC interface (variable baud rate) on main circuit board, for use with optional UL-listed printer PRN-6.

- Integral 80-character LCD display with backlighting.
- Real-time clock/calendar with automatic daylight savings control.
- Detector sensitivity test capability (NFPA 72 compliant).
- History file with 1,000-event capacity.
- Maintenance alert warns when smoke detector dust accumulation is excessive.
- Automatic device type-code verification.
- One person audible or silent walk test with walk-test log and printout.
- Point trouble identification.
- Waterflow (nonsilenceable) selection per monitor point.
- System alarm verification selection per detector point.
- PAS (Positive Alarm Sequence) and presignal delay per point (NFPA 72 compliant).

NOTE: Only detectors may participate in PAS.

SLC LOOP:

- SLC can be configured for NFPA Style 4, 6, or 7 operation.
- SLC supports up to 198 addressable devices per loop (99 detectors and 99 monitor, control, or relay modules).
- SLC loop maximum length 10,000 ft. (3,000 m.).
See installation manual for wire tables.

NOTIFICATION APPLIANCE CIRCUITS (NACS):

- Four onboard NACs with additional NAC capability using output control modules (NC-100). The four Class B NACs can be converted to four Class A NACs with optional ZNAC-92 converter module.
- Silence Inhibit and Auto Silence timer options.
- Continuous, March Time, Temporal or California code for main circuit board NACs with two-stage capability.
- Selectable strobe synchronization per NAC.
- 2.5 amps maximum per each NAC circuit.

NOTE: Maximum 24VDC system power output is shared among all NAC circuits and 24VDC special-application auxiliary power outputs. Total available output is 3.0 amps. Using the optional XRM-24B transformer increases 24VDC output to 6.0 amps.

PROGRAMMING AND SOFTWARE:

- Autoprogram (learn mode) reduces installation time.
- Custom English labels (per point) may be manually entered or selected from an internal library file.
- Three Form-C relay outputs (two programmable).
- 99 software zones.
- Continuous fire protection during online programming at the front panel.
- Program Check automatically catches common errors not linked to any zone or input point.
- **OFFLINE PROGRAMMING:** Create the entire program in your office using a Windows®-based software package (NFW2-100 requires PS-Tools Programming software, available on www.magni-fire.com). Upload/download system programming locally to the NFW2-100 Rev 3 in less than one minute.
- USB upload/download programming with standard Male-A to Male-B cable.

User Interface

LED INDICATORS

- AC Power (green)
- Fire Alarm (red)

- Supervisory (yellow)
- Alarm Silenced (yellow)
- System Trouble (yellow)
- Maintenance/Presignal (yellow)
- Disabled (yellow)
- Battery Fault (yellow)
- Ground Fault (yellow)

KEYPAD CONTROLS

- Acknowledge/Step
- Alarm Silence
- Drill
- System Reset (lamp test)
- 16-key alpha-numeric pad (similar to telephone keypad)
- 4 cursor keys
- Enter

Product Line Information

NFW2-100: FireWarden-100-2 Rev 3 198-point addressable Fire Alarm Control Panel, one SLC loop. Includes 80-character LCD display, single printed circuit board mounted on chassis, and cabinet. 120 VAC operation.

NFW2-100R: Same as NFW2-100, except in a red backbox.

NFW2-100E: Same as NFW2-100, except with 240 VAC operation.

4XTM Reverse Polarity Transmitter Module: Provides supervised output for local energy municipal box transmitter, alarm, and trouble.

ZNAC-92: Optional converter module which converts four (4) Style Y (Class B) NAC circuits to four (4) Style Z (Class A) circuits.

VWARDEN-CD: Contains PS-Tools Programming software for Windows®-based PC computer (cable not included), available on www.magni-fire.com.

DP-9692B: Optional dress panel for FireWarden-100-2 Rev 3.

TR-CE-B: Optional trim Ring for semi-flush mounting.

BB-26: Battery backbox, holds up to two 26 AH batteries and CHG-75.

NFS-LBB: Battery box, houses two 55 AH batteries.

CHG-75: Battery charger for lead-acid batteries with a rating of 25 to 75 AH.

CHG-120: Remote battery charging system for lead-acid batteries with a rating of 55 to 120 AH. Requires additional NFS-LBB for mounting.

NOTE: CHG-120 or CHG-75 required for batteries larger than 18AH.

BAT Series: Batteries, see data sheet DN-6933.

XRM-24B(E): Optional transformer. Increases system power output to 6.0 amps. Use XRM-24BE with FireWarden-100-2E Rev 3.

PRT/PK-CABLE: Cable printer/personal computer interface cable; required for printer or for local upload/download programming and updating panel firmware.

PRN-6: UL listed compatible event printer. Uses tractor-fed paper.

IPDACT-2/2UD, IPDACT Internet Monitoring Module: Mounts in bottom of enclosure with optional mounting kit (PN IPBRKT). Connects to primary and secondary DACT telephone output ports for internet communications over customer provided ethernet internet connection. Requires compatible

Teldat VisorALARM Central Station Receiver. Can use DHCP or static IP. (See data sheet DN-60408 for more information.)

IPBRKT: Mounting kit for IPDACT-2/2UD in common enclosure.

IPSPLT: Y-adaptor option allows connection of both panel dialer outputs to one IPDACT-2/2UD cable input.

COMPATIBLE ANNUNCIATORS

N-ANN-80(-W): LCD Annunciator is a remote LCD annunciator that mimics the information displayed on the FACP LCD display. Recommended wire type is un-shielded. (Basic model is black; order -W version for white; see DN-7114.)

N-ANN-LED: Annunciator Module provides three LEDs for each zone: Alarm, Trouble and Supervisory. Ships with red or black enclosure (see DN-60242).

N-ANN-RLED: Provides alarm (red) indicators for up to 30 input zones or addressable points. (See DN-60242).

N-ANN-RLY: Relay Module, which can be mounted inside the cabinet, provides 10 programmable Form-C relays. (See DN-7107.)

ROME-B: Relay Option Module Enclosure (order ROME-B for black or ROME for red). Provides one **N-ANN-RLY** Relay Module already installed. The ROME Series provides mounting space for one additional Relay Module or one addressable Multi-module. (See Installation Sheet PN 53530.)

N-ANN-S/PG: Serial/Parallel Printer Gateway module provides a connection for a serial or parallel printer. (See DN-7103.)

N-ANN-I/O: LED Driver Module provides connections to a user supplied graphic annunciator. (See DN-7105.)

ACM-8R: Relay module provides 8 Form-C 5.0 amp relays.

ACM Annunciator Series: LED-type fire annunciators capable of providing up to 99 software zones of annunciation. Available in increments of 16 or 32 points to meet a variety of applications.

LDM Graphic Series: Lamp Driver Module series for use with custom graphic annunciators.

FDU-80 (Liquid Crystal Display) point annunciator: 80-character, backlit LCD-type fire annunciators capable of displaying English-language text.

NOTE: For more information on Compatible Annunciators for use with the FireWarden-100-2 Rev 3, see the following data sheets (document numbers) **ACM-8R (DN-3558)**, **ACS/ACM Series (DN-0524)**, **LDM Series (DN-0551)**, **FDU-80 (DN-6820)**.

COMPATIBLE ADDRESSABLE DEVICES

All feature a polling LED and rotary switches for addressing.

NI-100: Addressable low-profile ionization smoke detector.

NP-100: Addressable low-profile photoelectric smoke detector.

NP-100T: Addressable low-profile photoelectric smoke detector with thermal sensor.

NP-100R: Addressable remote test capable detector for use with **DNR(W)** duct smoke detector housings.

NH-100: Fast-response, low-profile heat detector.

NH-100R: Fast-response, low-profile heat detector with rate-of-rise option.

NH-100H: Fixed high-temperature detector that activates at 190F/88C.

NP-A100: Addressable low-profile multi-sensor detector.

DNR: Innovair Flex low-flow non-relay duct-detector housing. Order NP-100R separately.

DNRW: Innovair Flex low-flow non-relay duct-detector housing, with NEMA-4 rating. Watertight. (Order NP-100R separately.)

NMM-100: Addressable Monitor Module for one zone of normally-open dry-contact initiating devices. Mounts in standard 4.0" (10.16 cm.) box. Includes plastic cover plate and end-of-line resistor. Module may be configured for either a Style B (Class B) or Style D (Class A) IDC.

NDM-100: Dual Monitor Module. Same as NMM-100 except it provides two Style B (Class B) only IDCs.

NMM-100P: Miniature version of NMM-100. Excludes LED and Style D option. Connects with wire pigtails. May mount in device backbox.

NZM-100: Similar to NMM-100, but may monitor up to 20 conventional two-wire detectors. Requires resettable 24 VDC power. Consult factory for compatible smoke detectors.

NC-100: Addressable Control Module for one Style Y/Z (Class B/A) zone of supervised polarized Notification Appliances. Mounts directly to a 4.0" (10.16 cm.) electrical box. Notification Appliance Circuit option requires external 24 VDC to power notification appliances.

NC-100R: Addressable relay module containing two isolated sets of Form-C contacts, which operate as a DPDT switch. Mounts directly to a 4.0" (10.16 cm.) box, surface mount using the SMB500.

NOT-BG12LX: Addressable manual pull station with interface module mounted inside.

N100-ISO: Fault Isolator Module. This module isolates the SLC loop from short circuit conditions (required for Style 6 or 7 operation).

SMB500: Used to mount all modules except the NMM-100P.

NMM-100-10: Ten-input monitor module. Mount one or two modules in a BB-XP cabinet (optional). Mount up to six modules on a CHS-6 chassis in a BB-25.

NZM-100-6: Six-zone interface module for compatible conventional two-wire detectors. Mount one or two modules in a BB-XP cabinet (optional). Mount up to six modules on a CHS-6 chassis in a BB-25.

NOTE: For more information on Compatible Addressable Devices for use with the FireWarden-100-2 Rev 3, see the following data sheets (document numbers): **N100-ISO (DN-6994)**, **NP-100 series (DN-6995)**, **NI-100 (DN-6996)**, **NH-100 series (DN-6997)**, **ND-100 series (DN-7006)**, **NP-A100 (DN-6998)**, **NMM-100/NMM-100P/NDM-100/NZM-100 (DN-6999)**, **NC-100/NC-100R (DN-7000)**, **NOT-BG12LX (DN-7001)**, **NMM-100-10 (DN-6990)**, and **NZM-100-6 (DN-60150)**.

Wiring Requirements

While shielded wire is not required, it is recommended that all SLC wiring be twisted-pair to minimize the effects of electrical interference. Wire size should be no smaller than 18 AWG (0.78 mm²) and no larger than 12 AWG (3.1 mm²). The wire size depends on the length of the SLC circuit. Refer to the panel manual for wiring details.

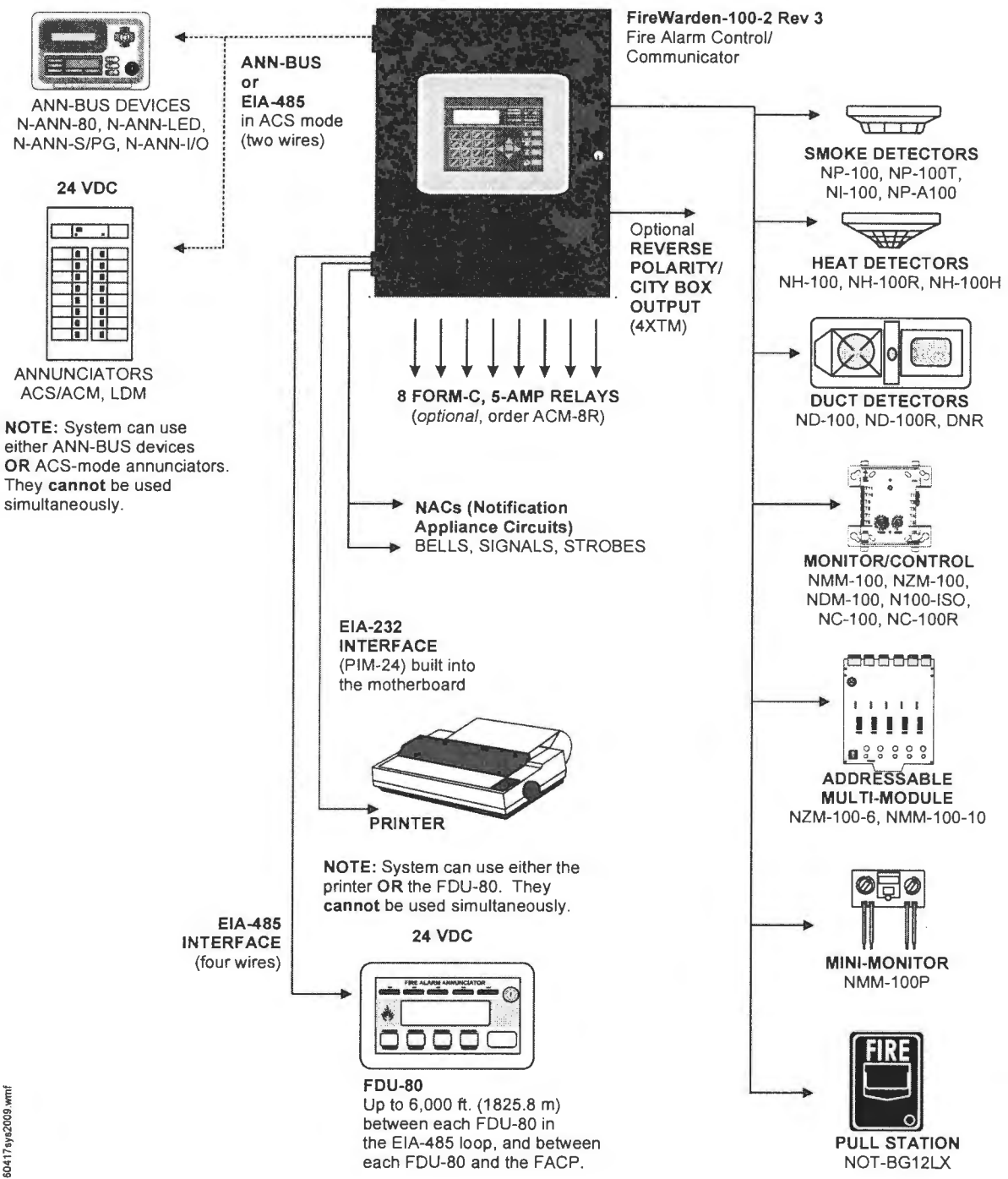

604Tsys2009.wmf

SYSTEM SPECIFICATIONS

System Capacity

- Intelligent Signalling Line Circuits..... 1
- Addressable device capacity 198
- Programmable software zones 99
- ACS Annunciators 32
- ANN-bus devices 16

Electrical Specifications

AC Power: FireWarden-100-2 Rev 3: 120 VAC, 60 Hz, 3.0 amps. FireWarden-100-2 Rev 3(E): 240 VAC, 50 Hz, 1.5 amps. Wire size: minimum 14 AWG (2.00 mm²) with 600 V insulation.

Battery: Two 12 V 18AH lead-acid batteries.

Battery charger capacity: 7 – 18 AH. FireWarden-100-2 Rev 3 cabinet holds maximum of two 18 AH batteries.

Communication Loop: Supervised and power-limited.

Notification Appliance Circuits: Each terminal block provides connections for two Style Y (Class B) for a total of four Style Y (Class B) or with an optional ZNAC-92 module converts to four Style Z (Class A) NACs. Maximum signaling current per circuit: 2.5 amps. End-of-Line Resistor: 4.7K ohm, 1/2 watt (P/N 71252 UL listed) for Style Y (Class B) NAC. Refer to panel documentation and *Notifier Device Compatibility Document* for listed compatible devices.

Two Programmable Relays and One Fixed Trouble Relay: Contact rating: 2.0 amps @ 30 VDC (resistive), 0.5 amps @ 30 VAC (resistive). Form-C relays.

Special Application Power (24 VDC Nominal): Jumper selectable (JP4) for conversion to resettable power output. Up to 1.0 amp total DC current available from each output. Power-limited.

Four-Wire Resettable Special Application Smoke Detector Power (24 VDC nominal): Up to 1.0 amp for powering four-wire smoke detectors. Power-limited. Refer to the *Notifier Device Compatibility Document* for listed compatible devices.

Remote Sync Output: Remote power supply synchronization output. Nominal special application power: 24 VDC. Maximum current: 300 mA. End-of-Line Resistor: 4.7K ohm. Output linked to NAC 1 control. Supervised and power-limited.

Telephone Interface: Unless used with Teldat VISORALARM, requires dedicated business telephone number with a minimum of 5 volts DC (off-hook voltage). Obtain dedicated phone line directly from your local phone company. Do not use shared phone lines or PBX (digital) type phone line extensions.

Cabinet Specifications

Door: 19.26" (48.92 cm.) high x 16.82" (42.73 cm.) wide x 0.12" (.30 cm.) deep. **Backbox:** 19.00" (48.26 cm.) high x 16.65" (42.29 cm.) wide x 5.20" (13.34 cm.) deep. **Trim Ring (TR-CE-B):** 22.00" (55.88 cm.) high x 19.65" (49.91 cm.) wide.

Shipping Specifications

Weight: 26.9 lbs. (12.20 kg.) **Dimensions:** 20.00" (50.80 cm.) high x 22.5" (57.15 cm.) wide x 8.5" (21.59 cm.) deep.

Temperature and Humidity Ranges

This system meets NFPA requirements for operation at 0 – 49°C/32 – 120°F and at a relative humidity 93% ± 2% RH (noncondensing) at 32°C ± 2°C (90°F ± 3°F). However, the useful life of the system's standby batteries and the electronic components may be adversely affected by extreme temperature ranges and humidity. Therefore, it is recommended that this system and its peripherals be installed in an environment with a normal room temperature of 15 – 27°C/60 – 80°F.

NFPA Standards

The FireWarden-100-2 Rev 3 complies with the following NFPA 72 Fire Alarm Systems requirements:

- **LOCAL** (Automatic, Manual, Waterflow and Sprinkler Supervisory).
- **AUXILIARY** (Automatic, Manual and Waterflow) (requires 4XTM).
- **REMOTE STATION** (Automatic, Manual, Waterflow and Sprinkler Supervisory) (Where a DACT is not accepted, the alarm, trouble and supervisory relays may be connected to UL 864 listed transmitters. For reverse polarity signaling of alarm and trouble, 4XTM is required.)
- **PROPRIETARY** (Automatic, Manual, Waterflow and Sprinkler Supervisory).
- **CENTRAL STATION** (Automatic, Manual, Waterflow and Sprinkler Supervisory).
- **OT, PSDN** (Other Technologies, Packet-switched Data Network)

Agency Listings and Approvals

The listings and approvals below apply to the basic FireWarden-100-2 Rev 3 control panel. In some cases, certain modules may not be listed by certain approval agencies, or listing may be in process. Consult factory for latest listing status.

- **UL Listed:** S635
- **FM approved**
- **CSFM:** 7165-0028:235

For ULC-listed version, see DN-60600.

FireWarden® and Notifier® are registered trademarks of Honeywell International Inc. Microsoft® and Windows® are registered trademarks of the Microsoft Corporation.

©2010 by Honeywell International Inc. All rights reserved. Unauthorized use of this document is strictly prohibited.



This document is not intended to be used for installation purposes. We try to keep our product information up-to-date and accurate. We cannot cover all specific applications or anticipate all requirements. All specifications are subject to change without notice.



Made in the U.S.A.

For more information, contact Notifier. Phone: (203) 484-7161, FAX: (203) 484-7118.

www.notifier.com

BAT Series Batteries

Sealed Lead-Acid or Gell Cell



Power Supplies

General

BAT Series Batteries feature a new part-numbering/listing system — providing an improved method of delivery for NOTIFIER-approved sealed lead-acid batteries for all your fire alarm system needs. Multiple brands of batteries are now offered under generic part numbers, reducing backorder situations and permitting us to deliver these products in a more timely fashion. NOTIFIER has approved the multiple brands listed below as possible product shipped for a given part number. Please note that any incoming orders for "PS Series" batteries will be converted to the equivalent BAT Series part numbers.

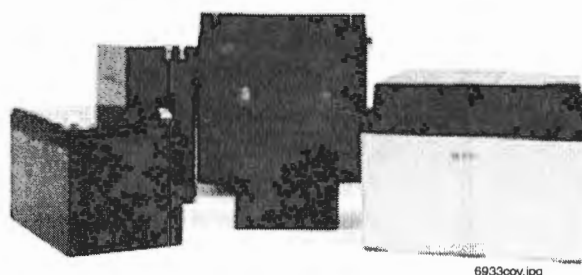

6933cov.jpg

Features

- Provide secondary power for control panels.
- Sealed and maintenance-free.
- Overcharge protected.
- Easy handling with leakproof construction.
- Ruggedly constructed, high-impact case (ABS, polystyrene, or polypropylene, depending on models).
- Long service life.
- Compact design.

Agency Listings and Approvals

The listings and approvals below apply to BAT Series Batteries. In some cases, certain modules may not be listed by certain approval agencies, or listing may be in process. Consult factory for latest listing status.

- **UL Recognized Components:** files MH19884 (*B & B Battery*), MH20567 (*UPG, previously Jolt*), MH20845 (*Power-Sonic*).

Part Number Reference

CURRENT Part Number	BATTERY DESCRIPTION	ALTERNATES APPROVED: manufacturers and P/Ns shipped under BAT P/Ns
BAT-1250	12 V, 5 AH, sealed.	BP5-12 (B&B Battery); PS-1250 (Power-Sonic); SA1250 (Jolt) to be replaced with UB1250 (UPG).
BAT-1250	12 V, 5 AH, sealed.	BP5-12 (B&B Battery); PS-1250 (Power-Sonic); SA1250 (Jolt) to be replaced with UB1250 (UPG).
BAT-1270	12 V, 7 AH, sealed.	BP7-12 (B&B Battery); PS-1270 (Power-Sonic); SA1272 (Jolt) to be replaced with UB1270 (UPG).
BAT-12120	12 V, 12 AH, sealed.	BP12-12 (B&B Battery); PS-12120 (Power-Sonic); SA12120 (Jolt) to be replaced with UB12120 (UPG).
BAT-12180	12 V, 18 AH, sealed.	PS-12180 (Power-Sonic); SA12180 (Jolt) to be replaced with UB12180 (UPG).
BAT-12180	12 V, 18 AH, sealed.	PS-12180 (Power-Sonic); SA12180 (Jolt) to be replaced with UB12180 (UPG).
BAT-12260	12 V, 26 AH, sealed.	BP26-12 (B&B Battery); PS-12260 (Power-Sonic); SA12260 (Jolt) to be replaced with UB12260 (UPG).
BAT-12550	12 V, 55 AH, sealed.	PS-12550 (Power-Sonic); XSA12550 (Jolt) to be replaced with UB12550 (UPG).
BAT-12550	12 V, 55 AH, sealed.	PS-12550 (Power-Sonic); XSA12550 (Jolt) to be replaced with UB12550 (UPG).
BAT-121000	12 V, 100 AH, gell cell.	PS-121000 (Power-Sonic); XSA121000A (Jolt) to be replaced with UB121000 (UPG).

POWER-SONIC

Part Number Reference

1109t1.tbl

MODEL	Nominal Voltage V	Nominal Capacity @ 20 hr. rate A.H.	Discharge Current @ 20 hr. rate mA	DIMENSIONS									
				Width		Depth		Height		Height over terminal		Weight	
				in.	mm	in.	mm	in.	mm	in.	mm	lb.	kg.
PS-1250	12	5	250	3.54	90	2.76	70	4.02	102	4.21	107	4.1	1.9
PS-1270	12	7	325	5.94	151	2.56	65	3.7	94	3.86	98	5.7	2.6
PS-12120	12	12	600	5.94	151	3.86	98	3.7	94	3.86	98	8.8	4
PS-12180	12	18	875	7.13	181	2.99	76	6.57	167	6.57	167	12.8	5.8
PS-12250	12	25	1300	6.89	175	6.54	166	4.92	125	4.92	125	18.7	8.5
PS-12550	12	55	3000	10.25	260	6.6	168	8.2	208	9.45	240	39.7	18
PS-121000	12	100	5000	12	305	6.6	168	8.2	208	9.45	240	65.7	29.8

Characteristic Discharge Curves

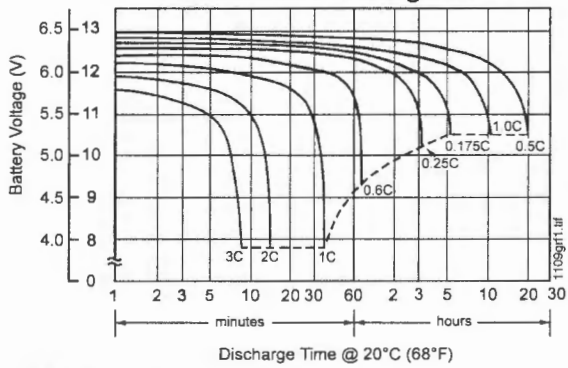

Effect of Temperature on Capacity

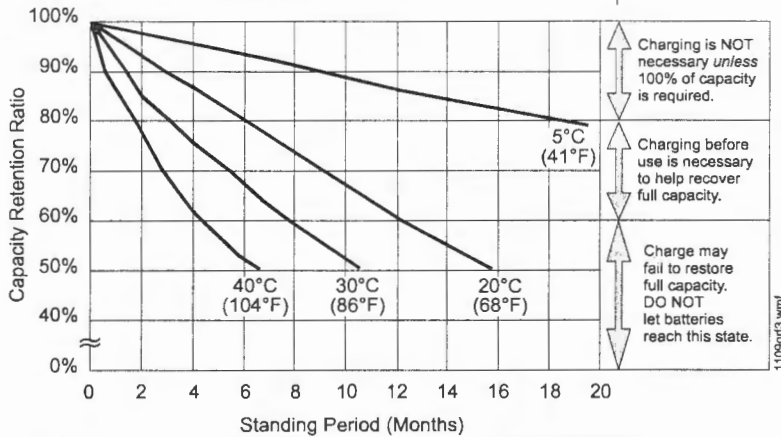
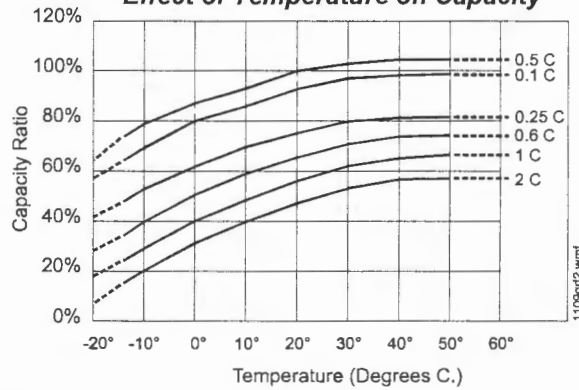

at left:
PS-121000
Shelf-Life
and Storage

at left:
PS-1210000
Discharge
Characteristics

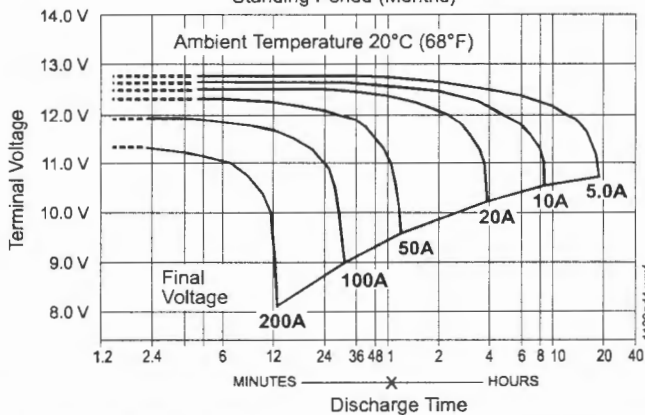

B & B BATTERY

Model	V	Nominal Capacity (AH)				Weight		Terminal				Dimensions							
		20 hr	10 hr	5 hr	1 hr	kg	lbs	Standard		Optional		L		W		H		TH	
								Type	Pos.	Type	Pos.	mm	in	mm	in	mm	in	mm	in
BP5-12	12	5.00	4.75	4.25	3.00	1.86	4.10	T1	3	T2		90	3.54	70	2.76	102	4.02	106	4.17
BP7-12	12	7.00	6.65	5.95	4.20	2.60	5.73	T2	5	T1		151	5.94	65	2.56	93	3.66	98	3.86
BP12-12	12	12.00	11.40	10.20	7.20	4.03	8.89	B1	5	T1		151	5.94	98	3.86	94	3.70	98	3.86
BP26-12	12	26.00	24.70	22.10	15.60	9.40	20.73	B1	7	T2.11	9	175	6.89	166	6.54	125	4.92	125	4.92

Charging Procedure

Application	Charging method	Charging voltage at 20°C (V/cell)	Temperature compensation coefficient of charging voltage (mV/°C/cell)	Maximum charging current (CA)	Charging time 0.1 CA, 20°C (h)		Temp (°C)
					100% discharge	50% discharge	
For standby power source	Constant voltage and constant current charging (with current restriction)	2.25 ~ 2.30	-3	0.3	24	20	0 - 40°C (32 ~ 104°F)
For cycle service		2.40 ~ 2.50	-4	0.3	16	10	

Temperature compensation of charging voltage is not needed when using the batteries within 5°C to 35°C range.

Final Voltage	Discharge Time: for Model BP5-12									
	5 min	10 min	15 min	30 min	1 hr	3 hr	5 hr	10 hr	20 hr	
	Battery Output Power (W): for Model BP5-12									
10.80 V	180.8	133.1	106.6	63.5	36.39	14.57	10.05	5.62	2.94	
10.50 V	209.2	144.2	111.5	65.9	37.48	14.87	10.20	5.70	3.00	
10.20 V	222.3	149.4	115.0	67.4	38.16	15.00	10.26	5.73	3.01	
9.90 V	232.3	152.9	117.6	68.3	38.61	15.10	10.29	5.75	3.02	
9.60 V	240.0	156.0	120.0	69.0	39.0	15.20	10.32	5.75	3.02	

Constant Power Discharge Characteristics at 25°C/77°F for BP5-12

Final Voltage	Discharge Time: for Model BP7-12									
	5 min	10 min	15 min	30 min	1 hr	3 hr	5 hr	10 hr	20 hr	
	Battery Output Power (W): for Model BP7-12									
10.80 V	253.1	186.3	149.3	88.8	50.95	20.40	14.07	7.86	4.11	
10.50 V	292.9	201.8	156.2	92.2	52.47	20.81	14.28	7.98	4.20	
10.20 V	311.2	209.1	161.0	94.3	53.42	21.00	14.36	8.02	4.22	
9.90 V	325.2	214.1	164.7	95.6	54.06	21.15	14.41	8.04	4.23	
9.60 V	336.0	218.4	168.0	96.6	54.60	21.27	14.45	8.04	4.23	

Constant Power Discharge Characteristics at 25°C/77°F for BP7-12

Final Voltage	Discharge Time: for Model BP12-12									
	5 min	10 min	15 min	30 min	1 hr	3 hr	5 hr	10 hr	20 hr	
	Battery Output Power (W): for Model BP12-12									
10.80 V	433.9	319.4	256.0	152.3	87.34	34.98	24.12	13.48	7.05	
10.50 V	502.2	346.0	267.7	158.1	89.96	35.68	24.48	13.68	7.20	
10.20 V	533.6	358.5	276.0	161.7	91.57	36.00	24.61	13.75	7.23	
9.90 V	557.5	367.1	282.4	164.0	92.67	36.25	24.70	13.79	7.25	
9.60 V	576.0	374.4	288.0	165.6	93.60	36.47	24.77	13.79	7.25	

Constant Power Discharge Characteristics at 25°C/77°F for BP12-12

Final Voltage	Discharge Time: for Model BP26-12									
	5 min	10 min	15 min	30 min	1 hr	3 hr	5 hr	10 hr	20 hr	
	Battery Output Power (W): for Model BP26-12									
10.80 V	940.0	692.0	554.6	330.0	189.23	75.79	52.25	29.20	15.26	
10.50 V	1088.0	749.7	580.0	342.5	194.91	77.30	53.04	29.64	15.60	
10.20 V	1156.0	776.7	598.0	350.3	198.41	78.00	53.33	29.79	15.67	
9.90 V	1208.0	795.3	611.8	355.2	200.79	78.54	53.52	29.88	15.71	
9.60 V	1248.0	811.2	624.0	358.8	202.80	79.01	53.68	29.88	15.71	

Constant Power Discharge Characteristics at 25°C/77°F for BP26-12

B & B BATTERY

BP5-12 Battery Discharge Characteristics (25°C/77°F)

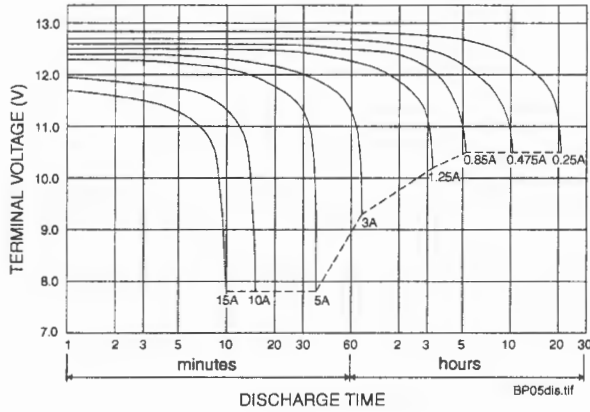

BP7-12 Battery Discharge Characteristics (25°C/77°F)

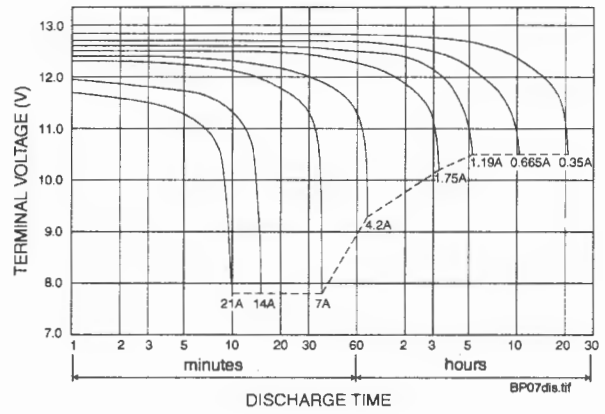

BP12-12 Battery Discharge Characteristics (25°C/77°F)

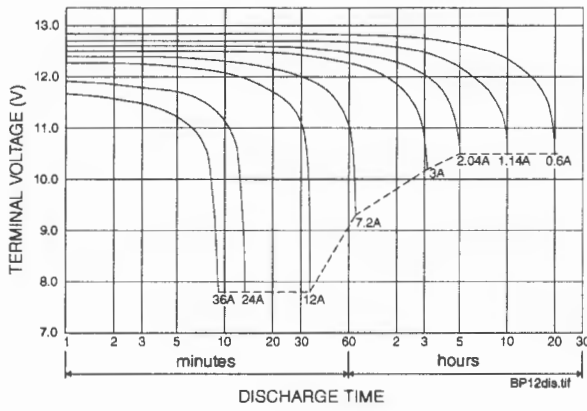

BP26-12 Battery Discharge Characteristics (25°C/77°F)

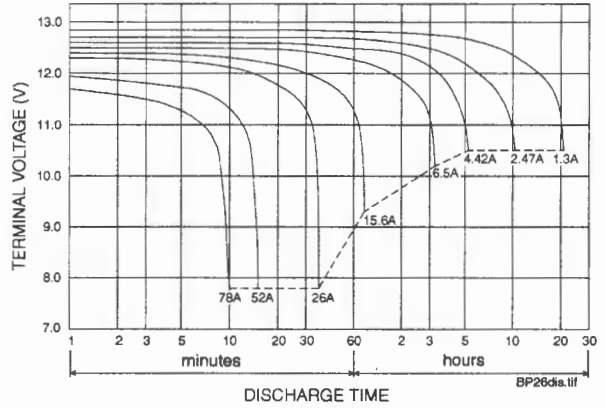

BP05-12



BP12-12



BP26-12



UPG BATTERY

UB1250 has the same specifications as previous Jolt SA1250;
SA1272 to be replaced with UB1270 (specs/diagrams pending).

UB1250 (previously SA1250) Diagrams

UB1250/SA1250 discharge current vs. time

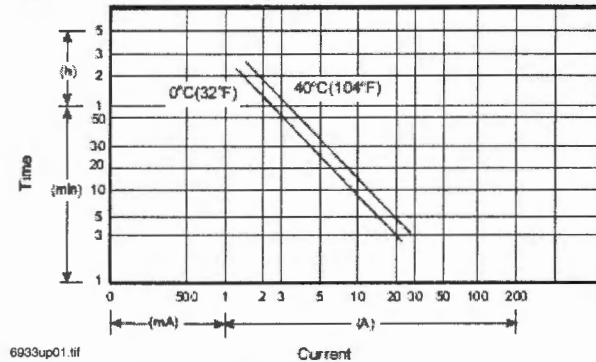

6933up01.tif

UB1250/SA1250 discharge characteristics (25°C/77°F)

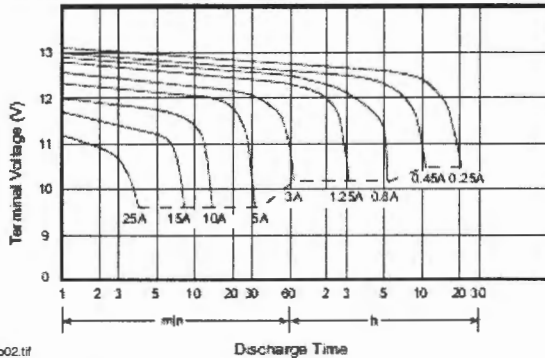

6933up02.tif

UB1250, SA1250 Specifications

- Nominal voltage: 12 V.
- Nominal capacity (20 hr): 5.0 AH.
- Dimensions: total height 107 mm (4.21"); container height 101 mm (3.98"); length 90 mm (3.54"); width 70 mm (2.76").
- Weight: approximately 1.83 kg (4.03 lbs).
- Container material: UL94HB ABS, UL94V-0 ABS.
- Internal resistance (25°C, 77°F): ~ 32 m.
- Discharge capacity under different temperatures:
 - 40°C: ~ 102%
 - 25°C: ~ 100%
 - 0°C: ~ 85%
- Capacity 25°C/77°F:
 - 20 hr @ 0.25 A: 5.0 AH.
 - 5 hr @ 0.8 A: 4.0 AH.
 - 1 hr @ 3.0 A: 3.0 AH.
 - 1 C @ 5.0 A: 2.5 AH.
- Charging voltage (25°C, 77°F):
 - Standby use: 13.65 V ± 0.15 V.
 - Cycle use: 14.7 V ± 0.3 V.
- Maximum discharge current: 60 A (5 sec).
- Maximum charging current: 1.5 A.
- Self-discharge residual capacity (25°C, 77°F):
 - After 3 months: ~ 90%.
 - After 6 months: ~ 82%.
 - After 12 months: ~ 70%.

SA1272 Diagrams

SA1272 discharge current vs. time

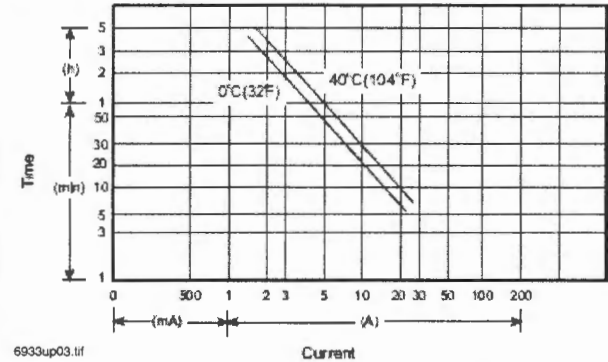

6933up03.tif

SA1272 discharge characteristics (25°C/77°F)

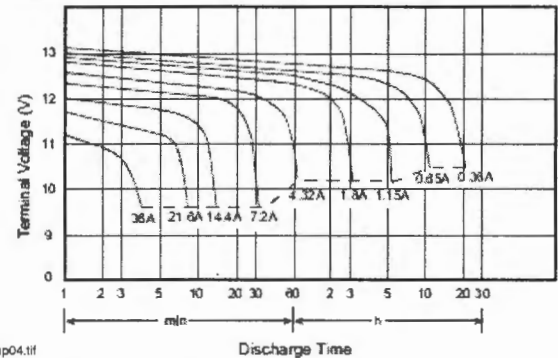

6933up04.tif

SA1272 Specifications

- Nominal voltage: 12 V.
- Nominal capacity (20 hr): 7.2 AH.
- Dimensions: total height 100 mm (3.94"); container height 94 mm (3.70"); length 151 mm (5.95"); width 65 mm (2.56").
- Weight: approximately 2.66 kg (5.85 lbs).
- Container material: UL94HB ABS, UL94V-0 ABS.
- Internal resistance (25°C, 77°F): ~ 22 m.
- Discharge capacity under different temperatures:
 - 40°C: ~ 102%
 - 25°C: ~ 100%
 - 0°C: ~ 85%
- Capacity 25°C/77°F:
 - 20 hr @ 0.36 A: 7.2 AH.
 - 5 hr @ 1.15 A: 5.76 AH.
 - 1 hr @ 4.32 A: 4.32 AH.
 - 1 C @ 7.2 A: 3.6 AH.
- Charging voltage (25°C, 77°F):
 - Standby use: 13.65 V ± 0.15 V.
 - Cycle use: 14.7 V ± 0.3 V.
- Maximum discharge current: 90 A (5 sec).
- Maximum charging current: 2.16 A.
- Self-discharge residual capacity (25°C, 77°F):
 - After 3 months: ~ 90%.
 - After 6 months: ~ 82%.
 - After 12 months: ~ 70%.

UPG BATTERY

Same specifications as previous Jolt models; packaging and part numbers are the only changes.

UB12120 (was SA12120) Diagrams

UB12120/SA12120 discharge current vs. time

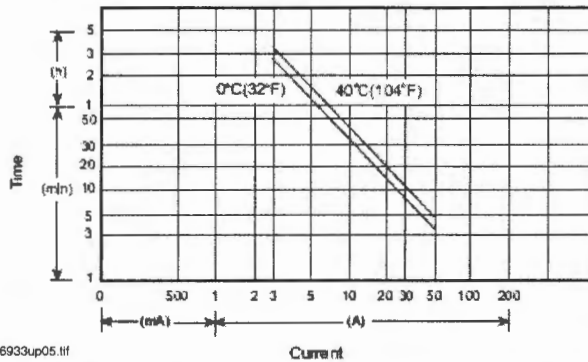

6933up05.tif

UB12180 (was SA12180) Diagrams

UB12180/SA12180 discharge current vs. time

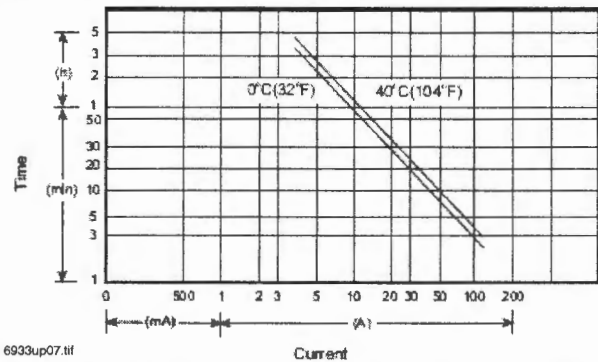

6933up07.tif

UB12120/SA12120 discharge characteristics (25°C/77°F)

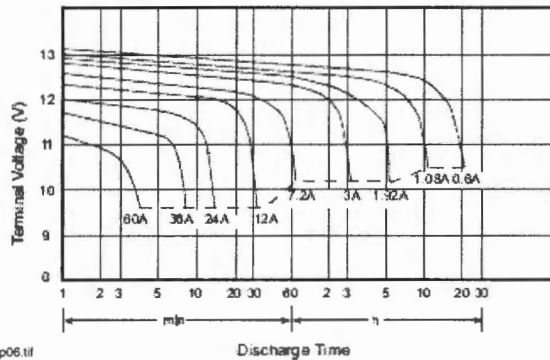

6933up06.tif

UB12180/SA12180 discharge characteristics (25°C/77°F)

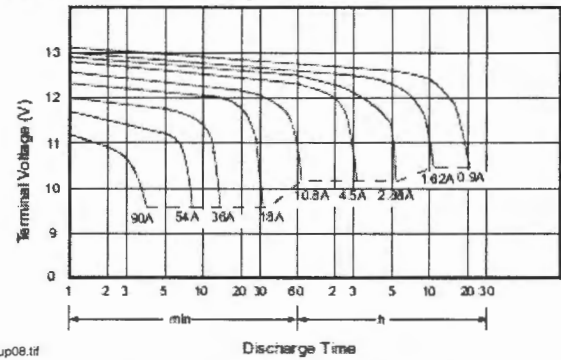

6933up08.tif

UB12120, SA12120 Specifications

- Nominal voltage: 12 V.
 - Nominal capacity (20 hr): 12.0 AH.
 - Dimensions: total height 100 mm (3.94"); container height 94 mm (3.70"); length 151 mm (5.95"); width 98 mm (3.86").
 - Weight: approximately 4.10 kg (9.04 lbs).
 - Container material: UL94HB ABS, UL94V-0 ABS.
 - Internal resistance (25°C, 77°F): ~ 14 m.
 - Discharge capacity under different temperatures:
 - 40°C: ~ 102%
 - 25°C: ~ 100%
 - 0°C: ~ 85%
 - Capacity 25°C/77°F:
 - 20 hr @ 0.6 A: 12.0 AH.
 - 5 hr @ 1.92 A: 9.6 AH.
 - 1 hr @ 7.2 A: 7.2 AH.
 - 1 C @ 12.0 A: 6.0 AH.
 - Charging voltage (25°C, 77°F):
 - Standby use: 13.65 V ± 0.15 V.
 - Cycle use: 14.7 V ± 0.3 V.
- Maximum discharge current: 120 A (5 sec).
 Maximum charging current: 3.6 A.
 Self-discharge residual capacity (25°C, 77°F):
 - After 3 months: ~ 90%.
 - After 6 months: ~ 82%.
 - After 12 months: ~ 70%.

UB12180, SA12180 Specifications

- Nominal voltage: 12 V.
 - Nominal capacity (20 hr): 18.0 AH.
 - Dimensions: total height 167 mm (6.58"); container height 167 mm (6.58"); length 181 mm (7.13"); width 76 mm (2.29").
 - Weight: approximately 6.06 kg (13.36 lbs).
 - Container material: UL94HB ABS, UL94V-0 ABS.
 - Internal resistance (25°C, 77°F): ~ 13 m.
 - Discharge capacity under different temperatures:
 - 40°C: ~ 102%
 - 25°C: ~ 100%
 - 0°C: ~ 85%
 - Capacity 25°C/77°F:
 - 20 hr @ 0.9 A: 18.0 AH.
 - 5 hr @ 2.88 A: 14.4 AH.
 - 1 hr @ 10.8 A: 10.8 AH.
 - 1 C @ 18.0 A: 9.0 AH.
 - Charging voltage (25°C, 77°F):
 - Standby use: 13.65 V ± 0.15 V.
 - Cycle use: 14.7 V ± 0.3 V.
- Maximum discharge current: 300 A (5 sec).
 Maximum charging current: 5.4 A.
 Self-discharge residual capacity (25°C, 77°F):
 - After 3 months: ~ 90%.
 - After 6 months: ~ 82%.
 - After 12 months: ~ 70%.

UPG BATTERY

Same specifications as previous Jolt models;
packaging and part numbers are the only changes.

UB12260 (was SA12260) Diagrams

UB12260/SA12260 discharge current vs. time

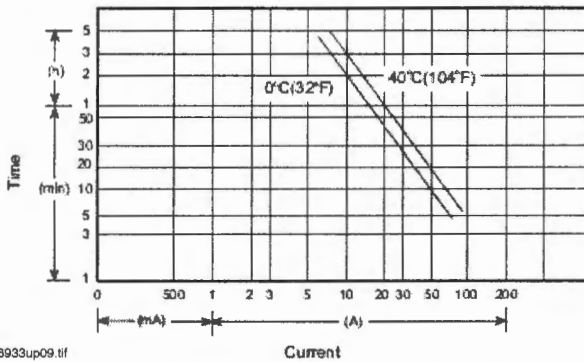

6933up09.tif

UB12550 (was SA12550) Diagrams

UB12550/SA12550 discharge current vs. time

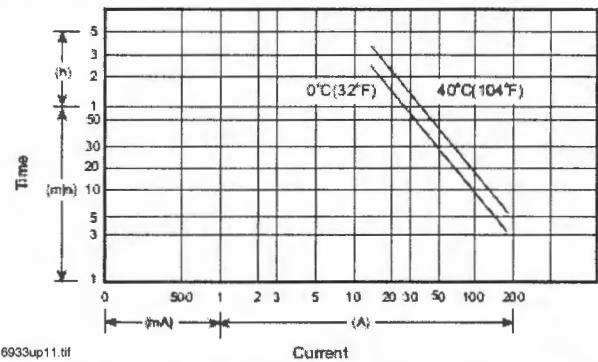

6933up11.tif

UB12260/SA12260 discharge characteristics (25°C/77°F)

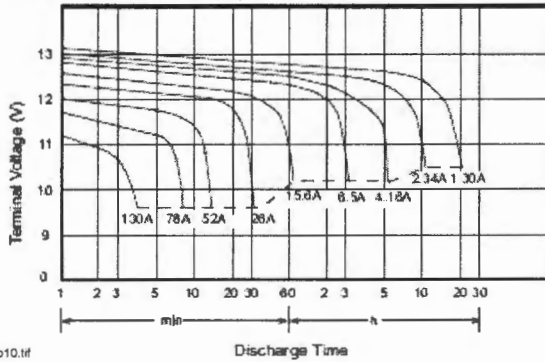

6933up10.tif

UB12550/SA12550 discharge characteristics (25°C/77°F)

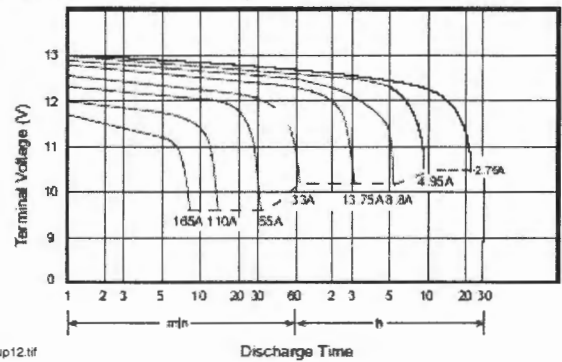

6933up12.tif

UB12260, SA12260 Specifications

- Nominal voltage: 12 V.
- Nominal capacity (20 hr): 26.0 AH.
- Dimensions: total height 125 mm (4.92"); container height 125 mm (4.92"); length 166 mm (6.54"); width 175 mm (6.89").
- Weight: approximately 8.80 kg (19.40 lbs).
- Container material: UL94HB ABS, UL94V-0 ABS.
- Internal resistance (25°C, 77°F): ~ 10 m.
- Discharge capacity under different temperatures:
 - 40°C: ~ 102%
 - 25°C: ~ 100%
 - 0°C: ~ 85%
- Capacity 25°C/77°F:
 - 20 hr @ 1.3 A: 26.0 AH.
 - 5 hr @ 4.16 A: 20.8 AH.
 - 1 hr @ 15.6 A: 15.6 AH.
 - 1 C @ 26.0 A: 13.0 AH.
- Charging voltage (25°C, 77°F):
 - Standby use: 13.65 V ± 0.15 V.
 - Cycle use: 14.7 V ± 0.3 V.
- Maximum discharge current: 300 A (5 sec).
- Maximum charging current: 7.8 A.
- Self-discharge residual capacity (25°C, 77°F):
 - After 3 months: ~ 90%.
 - After 6 months: ~ 82%.
 - After 12 months: ~ 70%.

UB12550, SA12550 Specifications

- Nominal voltage: 12 V.
- Nominal capacity (20 hr): 55.0 AH.
- Dimensions: total height 234.5 mm (9.23"); container height 216.5 mm (8.52"); length 229 mm (9.02"); width 138 mm (5.43").
- Weight: approximately 19.0 kg (41.8 lbs).
- Container material: UL94HB ABS, UL94V-0 ABS.
- Internal resistance (25°C, 77°F): ~ 8 m.
- Discharge capacity under different temperatures:
 - 40°C: ~ 102%
 - 25°C: ~ 100%
 - 0°C: ~ 85%
- Capacity 25°C/77°F:
 - 20 hr @ 2.75 A: 55.0 AH.
 - 5 hr @ 8.8 A: 44.0 AH.
 - 1 hr @ 33.0 A: 33.0 AH.
 - 1 C @ 55.0 A: 27.5 AH.
- Charging voltage (25°C, 77°F):
 - Standby use: 13.65 V ± 0.15 V.
 - Cycle use: 14.7 V ± 0.3 V.
- Maximum discharge current: 600 A (5 sec).
- Maximum charging current: 16.5 A.
- Self-discharge residual capacity (25°C, 77°F):
 - After 3 months: ~ 90%.
 - After 6 months: ~ 82%.
 - After 12 months: ~ 70%.

UPG BATTERY

Same specifications as previous Jolt models; packaging and part numbers are the only changes.

UB121000 (XSA121000A) Diagrams

UB121000/XSA121000A discharge current vs. time

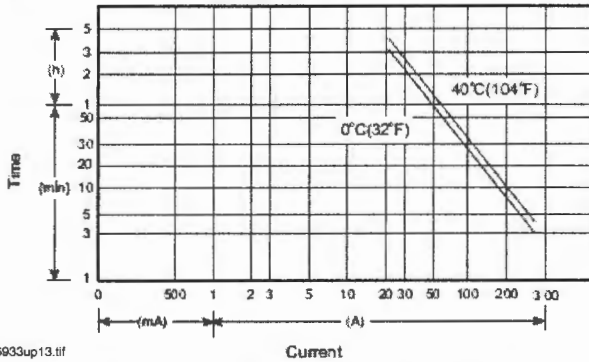

6933up13.tif

UB121000/XSA121000A discharge characteristics (25°C/77°F)

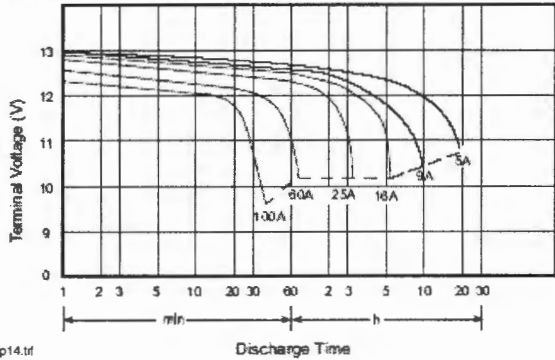

6933up14.tif

UB121000 (XSA121000A) Diagrams

- Nominal voltage: 12 V.
- Nominal capacity (20 hr): 100.0 AH.
- Dimensions: total height 221 mm (8.70"); container height 214 mm (8.43"); length 329 mm (12.95"); width 172 mm (6.77").
- Weight: approximately 34.00 kg (74.8 lbs).
- Container material: UL94HB ABS, UL94V-0 ABS.
- Internal resistance (25°C, 77°F): ~ 6.5 m.
- Discharge capacity under different temperatures:
 - 40°C: ~ 102%
 - 25°C: ~ 100%
 - 0°C: ~ 85%
- Capacity 25°C/77°F:
 - 20 hr @ 5.0 A: 100.0 AH.
 - 5 hr @ 16.0 A: 80.0 AH.
 - 1 hr @ 60.0 A: 60.0 AH.
 - 1 C @ 100.0 A: 50.0 AH.
- Charging voltage (25°C, 77°F):
 - Standby use: 13.65 V ± 0.15 V.
 - Cycle use: 14.7 V ± 0.3 V.
- Maximum discharge current: 600 A (5 sec).
- Maximum charging current: 30 A.
- Self-discharge residual capacity (25°C, 77°F):
 - After 3 months: ~ 90%.
 - After 6 months: ~ 82%.
 - After 12 months: ~ 70%.

UPG Summary Diagrams

Summary discharge characteristics

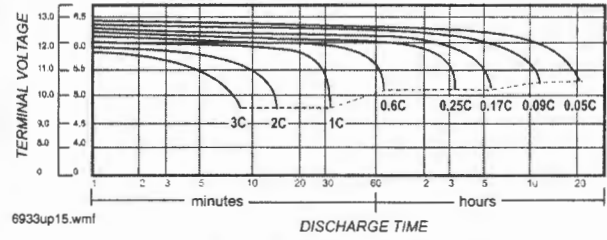

6933up15.wmf

Summary discharge current vs. time curve (25°C/77°F)

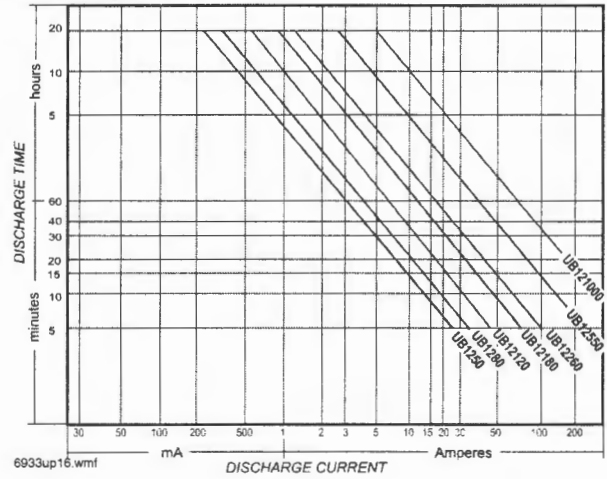

6933up16.wmf



6933ub1280.jpg



6933ub12260.jpg

UPG BATTERY

Same specifications as previous Jolt models;
packaging and part numbers are the only changes.

Charging Procedure: UPG Battery

Application	Charging method	Charging voltage at 25°C (V/cell)	Temperature compensation coefficient of charging voltage (mV/°C/cell)	Maximum charging current (CA)	Charging time 0.1 CA, 25°C (h)		Temp (°C)
					100% discharge	50% discharge	
For standby power source	Constant voltage and constant current charging (with current restriction)	2.25 ~ 2.30	-3.3 (-1.8 mV/°F/cell)	0.3	T ³ 24	T ³ 20	0 ~ 40°C (32 ~ 104°F)
For cycle service		2.40 ~ 2.50	-5 (-2.8 mV/°F/cell)	0.3	16 < T < 24	10 < T < 24	

Temperature compensation of charging voltage is not needed when using the batteries within 5°C to 35°C range.

NOTIFIER® is a registered trademark of Honeywell International Inc.
Batteries display trademarks of the manufacturer.
©2009 by Honeywell International Inc. All rights reserved. Unauthorized use
of this document is strictly prohibited.

ISO 9001
CERTIFIED
ENGINEERING & MANUFACTURING
QUALITY SYSTEMS

This document is not intended to be used for installation purposes.
We try to keep our product information up-to-date and accurate.
We cannot cover all specific applications or anticipate all requirements.
All specifications are subject to change without notice.

For more information, contact Notifier. Phone: (203) 484-7161, FAX: (203) 484-7118.
www.notifier.com



One Stanton Street
Marinette, WI 54143

DETECTION AND CONTROL EQUIPMENT
DATA SHEET
4XTM TRANSMITTER MODULE

Part No. 417470

4XTM TRANSMITTER MODULE
(POLARITIES SHOWN IN ACTIVATED POSITIONS)

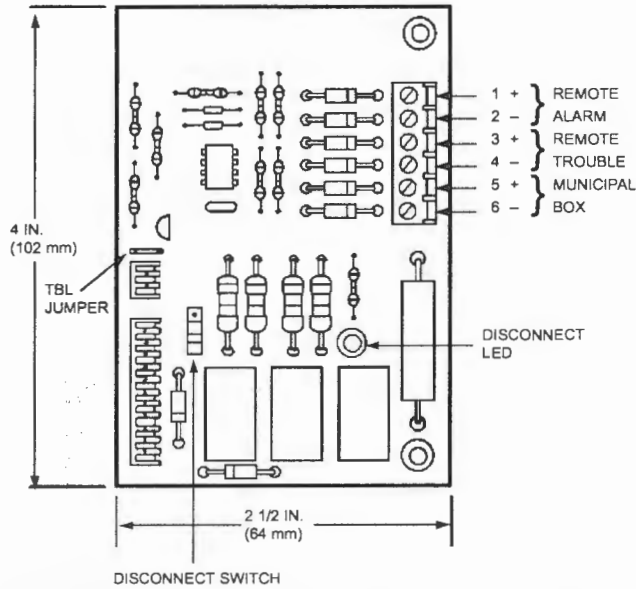

Description

The 4XTM Transmitter Module is an option for the Pyro-Chem control systems. The module provides a supervised output for local energy municipal box transmitter (for NFPA 72 Auxiliary Protective Signaling System) and alarm and trouble reverse polarity circuits (for NFPA 72 Remote Station Protective Signaling System). Also included is a DISABLE switch and disable trouble LED. A jumper option allows the reverse polarity circuit to open with a System Trouble condition if no alarm condition exists.

Technical Information

For Local Energy Municipal Box service (NFPA 72 Auxiliary Protective Signaling System):

- Supervisory Current 5.0 mA
- Trip Current 0.35 amps (subtracted from indicating appliance power)
- Coil Voltage 3.65 VDC
- Coil Resistance 14.6 ohms
- Total wire resistance between unit and trip coil 3 ohms

For Remote Station service (NFPA 72 Remote Station Protective Signaling System):

- Maximum Load for each circuit 10 mA
- Reverse Polarity Output Voltage 24 VDC

Listings and Approvals*

- UL S635
- ULC CS118, CS733
- Factory Mutual Research Corporation (FMRC) 0V4A5.AY
- MEA. 104-93-E

* Listings and Approvals are under NOTIFIER Division of Pittway Corporation

Ordering Information

Part No.	Description	Shipping Weight	
		lb.	(kg)
417470	4XTM Transmitter Module	1	(0.5)

NOT-BG12LX

Addressable Manual Pull Station For FireWarden Series Panels



Intelligent/Addressable Devices

General

The Notifier NOT-BG12LX is a state-of-the-art, dual-action (i.e., requires two motions to activate the station) pull station that includes an addressable interface for FireWarden series intelligent control panels, and the NSP-25 panel. Because the NOT-BG12LX is addressable, the control panel can display the exact location of the activated manual station. This leads fire personnel quickly to the location of the alarm.

Features

- Maintenance personnel can open station for inspection and address setting without causing an alarm condition.
- Built-in bicolor LED, which is visible through the handle of the station, flashes in normal operation and latches steady red when in alarm.
- Handle latches in down position and the word "ACTIVATED" appears to clearly indicate the station has been operated.
- Captive screw terminals wire-ready for easy connection to SLC loop (accepts up to 12 AWG/3.25 mm² wire).
- Can be surface mounted (with SB-10 or SB-I/O) or semi-flush mounted. Semi-flush mount to a standard single-gang, double-gang, or 4" (10.16 cm) square electrical box.
- Smooth dual-action design.
- Meets ADAAG controls and operating mechanisms guidelines (Section 4.1.3[13]); meets ADA requirement for 5 lb. maximum activation force.
- Highly visible.
- Attractive shape and textured finish.
- Key reset.
- Includes Braille text on station handle.
- Optional trim ring (BG12TR).
- Meets UL 38, Standard for Manually Actuated Signaling Boxes.

Construction

Shell, door, and handle are molded of durable polycarbonate material with a textured finish.

Specifications

- **Shipping Weight:** 9.6 oz. (272.15 g)
- **Normal operating voltage:** 24 VDC.
- **Maximum SLC loop voltage:** 28.0 VDC.
- **Maximum SLC loop current:** μ A.
- **Temperature Range:** 32°F to 120°F (0°C to 49°C)
- **Relative Humidity:** 10% to 93% (noncondensing)
- **For use indoors in a dry location**

Installation

The NOT-BG12LX will mount semi-flush into a single-gang, double-gang, or standard 4" (10.16 cm) square electrical outlet box, or will surface mount to the model SB-10 or SB-I/O surface backbox. If the NOT-BG12LX is being semi-flush mounted, then the optional trim ring (BG12TR) may be used.



The NOT-BG12LX
Addressable Manual Pull Station

The BG12TR is usually needed for semi-flush mounting with 4" (10.16 cm) or double-gang boxes (not with single-gang boxes).

Operation

Pushing in, then pulling down on the handle causes it to latch in the down/activated position. Once latched, the word "ACTIVATED" (in bright yellow) appears at the top of the handle, while a portion of the handle protrudes from the bottom of the station. To reset the station, simply unlock the station with the key and pull the door open. This action resets the handle; closing the door automatically resets the switch.

Each manual station, on command from the control panel, sends data to the panel representing the state of the manual switch. Two rotary decimal switches allow address settings (1 – 99 on NFW2-100/NFW2-100C, 1 – 50 for NFW-50/NFW-50C).

Architectural/Engineering Specifications

Manual Fire Alarm Stations shall be non-coded, with a key-operated reset lock in order that they may be tested, and so designed that after actual Emergency Operation, they cannot be restored to normal except by use of a key. An operated station shall automatically condition itself so as to be visually detected as activated. Manual stations shall be constructed of red-colored polycarbonate material with clearly visible operating instructions provided on the cover. The word FIRE shall appear on the front of the stations in white letters, 1.00 inches (2.54 cm) or larger. Stations shall be suitable for surface mounting on matching backbox SB-10 or SB-I/O; or semi-flush mounting on a standard single-gang, double-gang, or 4" (10.16 cm) square electrical box, and shall be installed within

the limits defined by the Americans with Disabilities Act (ADA) or per national/local requirements. Manual Stations shall be Underwriters Laboratories listed.

Manual stations shall connect with two wires to one of the control panel SLC loops. The manual station shall, on command from the control panel, send data to the panel representing the state of the manual switch. Manual stations shall provide address setting by use of rotary decimal switches.

Product Line Information

NOT-BG12LX: Dual-action addressable pull station. Includes key locking feature.

NOT-BG12LXA: *Canadian* Dual-action addressable pull station. Includes key locking feature.

SB-10: Surface backbox; metal.

SB-I/O: Surface backbox; plastic.

BG12TR: Optional trim ring.

17021: Keys, set of two.

Agency Listings and Approvals

In some cases, certain modules or applications may not be listed by certain approval agencies, or listing may be in process. Consult factory for latest listing status.

- **UL Listed:** S692 (listed for Canadian and non-Canadian applications)
- **MEA:** 67-02-E Vol. IV
- **CSFM:** 7150-0028:0199
- **FDNY:**
- **FM Approved**

Patented: U.S. Patent No. D428,351; 6,380,846; 6,314,772; 6,632,108.

Notifier® is a registered trademark of Honeywell International Inc.
©2010 by Honeywell International Inc. All rights reserved. Unauthorized use of this document is strictly prohibited.



This document is not intended to be used for installation purposes.
We try to keep our product information up-to-date and accurate.
We cannot cover all specific applications or anticipate all requirements.
All specifications are subject to change without notice.



Made in the U.S.A.

For more information, contact Notifier. Phone: (203) 484-7161, FAX: (203) 484-7118.
www.notifier.com

NP-100(A), NP-100T(A), NP-100R(A)

dn-6995:b • A1-320

Addressable Photoelectric Detectors for the FireWarden Series



Addressable

General

The NP-100 and NP-100T addressable, low-profile plug-in photoelectric detectors use a state-of-the-art photoelectric sensing chamber with communications to provide open area protection and are used exclusively with NOTIFIER's FireWarden Series (FireWarden-100-2 and FireWarden-50) Addressable Fire Alarm Control Panels (FACPs). The NP-100T adds thermal sensors that will alarm at a fixed temperature of 135°F (57°C). Since these detectors are addressable, they will help emergency personnel quickly locate a fire during its early stages, potentially saving precious rescue time while also reducing property damage. Two LEDs on each sensor light to provide a local, visible sensor indication. Remote LED annunciator capability is available as an optional accessory (P/N RA100Z(A)). The NP-100R is a remote test capable detector for use with DNR(W) duct smoke detector housings.

Features

SLC loop:

- Two-wire loop connection.
- Unit uses base for wiring.

Addressing:

- Addressable by device.
- Direct Decade entry of address: 01 – 99 with FireWarden-100-2, and 01 – 50 with FireWarden-50.

Architecture:

- Unique single-source, dual-chamber design to respond quickly and dependably to a broad range of fires.
- Sleek, low-profile design.
- Integral communications and built-in type identification.
- Built-in tamper-resistant feature.
- Removable cover and insect-resistant screen for simple field cleaning.

Operation:

- Withstands air velocities up to 4,000 feet-per-minute (20 m/sec.) without triggering a false alarm.
- Factory preset at 1.5% nominal sensitivity for panel alarm threshold level.
- Visible LED "blinks" when the unit is addressed (communicating with the fire panel) and latches on in alarm.

Mechanicals:

- Sealed against back pressure.
- Direct surface mounting or electrical box mounting.
- Mounts to: single-gang box, 3.5" (8.89 cm) or 4.0" (10.16 cm) octagonal box, or 4.0" (10.16 cm) square electrical box (using a plaster ring — included).

Other system features:

- Fully coated circuit boards and superior RF/transient protection.
- 94-V0 plastic flammability rating.
- Low standby current.

Options:

- Remote LED output connection (P/N RA100Z).



NP-100 with B710LP base



NP-100T with B710LP base

Applications

Use photoelectric detectors in life-safety applications to provide a broad range of fire-sensing capability, especially where smoldering fires are anticipated. Ionization detectors are often better than photoelectric detectors at sensing fast, flaming fires.

Construction

These detectors are constructed of off-white LEXAN®. NP-100(T) plug-in, low-profile smoke detectors are designed to commercial standards and offer an attractive appearance.

Installation

NP-100(T) plug-in detectors use a detachable mounting base to simplify installation, service and maintenance. Mount base on box which is at least 1.5 inches (3.81 cm) deep. Suitable boxes include:

- 4.0" (10.16 cm) square box with plaster ring.
- 4.0" (10.16 cm) octagonal box.
- 3.5" (8.89 cm) octagonal box.
- Single-gang box.

NOTE: Because of the inherent supervision provided by the SLC loop, **end-of-line resistors** are not required. Wiring "T-taps" or branches are permitted for Style 4 (Class B) wiring. NP-100R mounts in a DNR(W) duct detector housing.

Operation

Each NP-100/T/R uses one of 99 possible addresses on the FireWarden-100-2 and one of 50 possible addresses on the FireWarden-50 Signaling Line Circuit (SLC). It responds to regular polls from the system and reports its type and status.

The NP-100/T/R addressable photoelectric sensor's unique unipolar chamber responds quickly and uniformly to a broad range of smoke conditions and can withstand wind gusts up to 4,000 feet-per-minute (20 m/sec.) without sending an alarm level signal. Because of its unipolar chamber, the NP-100/T/R is approximately two times more responsive than most photoelectric sensors. This makes it a more stable detector.

Detector Sensitivity Test

Each detector can have its sensitivity tested (required per NFPA 72, Chapter 14 on *Inspection, Testing and Maintenance*) when installed/connected to a FireWarden-100-2 or FireWarden-50 addressable fire alarm control panel. The results of the sensitivity test can be printed off the FireWarden-100-2 or FireWarden-50 for record keeping.

Specification

Voltage range: 15 – 32 VDC (peak).

Standby current: 300 µA @ 24 VDC.

LED current: 6.5 mA @ 24 VDC (latched "ON").

Air velocity: 4,000 ft./min. (20 m/sec.) maximum.

Diameter: 6.1" (15.5 cm) installed in B710LP base.

Height: 2.1" (5.33 cm) installed in B710LP base.

Weight: 3.6 oz. (102 g).

Operating temperature range: for NP-100: 0°C to 49°C (32°F to 120°F); for NP-100T: 0°C to 38°C (32°F to 100°F). NP-100R: installed in a DNR(W) -20°C to 70°C (-4°F to 158°F).

Temperature: 0°C – 49°C (32°F – 120°F).

Relative humidity: 10% – 93%, non-condensing.

Listings

Listings and approvals below apply to the NP-100 and NP-100T detectors. In some cases, certain modules may not be listed by certain approval agencies, or listing may be in process. Consult factory for latest listing status.

- UL Listed, file S1115.
- CSFM approved: file 7272-0028:231.
- MEA approved: file 243-02-E Vol. 2.
- Maryland State Fire Marshal: permit 2173.
- FM approved.

Product Line Information

NP-100: Addressable photoelectric detector; B710LP base included.

NP-100A: Same as NP-100 with ULC Listing (B710LPA base included).

NP-100T: Same as NP-100 but with *thermal* element; B710LP base included.

NP-100TA: Same as NP-100T with ULC Listing (B710LPAbase included).

NP-100R: Remote test capable addressable photoelectric detector for use with a DNR(W) duct detector housing.

B710LP: Plug-in detector base. Dimensions: 6.1" (15.5 cm). Mounting: 4.0" (10.16 cm) square box with or without plaster ring, 4.0" (10.16 cm) octagonal box, 3.5" (8.89 cm) octagonal box, or single-gang box. All mounting boxes have a minimum depth of 1.5" (3.81 cm).

B224RB: Plug-in System Sensor *relay* detector base. **Diameter:** 6.2" (15.75 cm). **Mounting:** 4.0" (10.16 cm) square box with or without plaster ring, 4.0" (10.16 cm) octagonal box, or 3.5" (8.89 cm) octagonal box. All mounting boxes have a minimum depth of 1.5" (3.81 cm).

B224BI: Plug-in System Sensor *isolator* detector base. Maximum 25 devices between isolator bases (see DN-6994). **Diameter:** 6.2" (15.75 cm). **Mounting:** 4.0" (10.16 cm) square box with or without plaster ring, 4.0" (10.16 cm) octagonal box, or 3.5" (8.89 cm) octagonal box. All mounting boxes have a minimum depth of 1.5" (3.81 cm).

B200SR: Sounder base capable of producing temporal-3 or steady sound output.

ACCESSORIES:

RA100Z(A): Remote LED annunciator. 3 – 32 VDC. Mounts to a U.S. single-gang electrical box. For use with B501 and B710LP bases only.

SMK400E: Surface mounting kit provides for entry of surface wiring conduit. For use with B501 base only.

RMK400: Recessed mounting kit. For use with B501 base only.

M02-04-00: Test magnet.

M02-09-00: Test magnet with telescoping handle.

XR2B: Detector removal tool. Allows installation and/or removal of detector heads from bases in high ceiling applications.

XP-4: Extension pole for XR2B. Comes in three 5-foot (1.524 m) sections.

T55-127-010: Detector removal tool without pole.

BCK-200B: Black detector covers, box of 10 .

WCK-200B: White detector covers, box of 10 .

NOTIFIER® is a registered trademark of Honeywell International Inc. Bayblend® is a registered trademark of Bayer Corporation. ©2008 by Honeywell International Inc. All rights reserved. Unauthorized use of this document is strictly prohibited.



This document is not intended to be used for installation purposes.
We try to keep our product information up-to-date and accurate.
We cannot cover all specific applications or anticipate all requirements.
All specifications are subject to change without notice.

For more information, contact Notifier. Phone: (203) 484-7161, FAX: (203) 484-7118.
www.notifier.com

InnovairFlex

Intelligent Non-Relay Photoelectric Duct Smoke Detector



Intelligent Devices

General

The Notifier InnovairFlex DNR intelligent non-relay photoelectric duct smoke detector and DNRW watertight non-relay photoelectric duct smoke detector feature a pivoting housing that fits both square and rectangular footprints capable of mounting to a round or rectangular duct.

DNRW duct smoke detector, with its NEMA-4 rating, is listed as a watertight, UV resistant enclosure providing protection against falling dirt, rain, and windblown dust, splashing and hose directed water, allowing operators to use the detector in the most extreme environments.

These units sense smoke in the most challenging conditions, operating in airflow speeds of 100 to 4,000 feet per minute, temperatures of -4 degrees F to 158 degrees F, and a humidity range of 0 to 95 percent (non-condensing.)

An improved cover design isolates the sensor head, which allows for ease of maintenance. A cover tamper feature indicates a trouble signal for a removed or improperly installed sensor cover. The Notifier InnovairFlex housing provides a 3/4-inch conduit knockout and ample space to facilitate easy wiring and mounting of a relay module.

The Notifier InnovairFlex duct smoke detector can be customized to meet local codes and specifications without additional wiring. The new InnovairFlex product line is compatible with all previous Innovair models, including remote test accessories.

Features

- Photoelectric, integrated low-flow technology
- Air velocity rating from 100 ft/min to 4,000 ft/min (0.5 m/s to 20.32 m/s)
- Versatile mounting options: square or rectangular configuration
- Broad ranges for operating temperature (-4F to 158F) and humidity (0% to 95% non-condensing)
- Patented sampling tube installs from front or back of the detector with no tools required
- Cover tamper signal
- Increased wiring space with a newly added 3/4" conduit knockout
- Available space within housing to accommodate mounting of a relay module
- Easily accessible code wheels on sensor head (sold separately)
- Clear cover for convenient visual inspection
- Remote testing capability
- Requires com line power only
- Accommodates the installation of an addressable relay module, sold separately, (FRM-1 or NC-100R) for applications requiring a Form-C relay

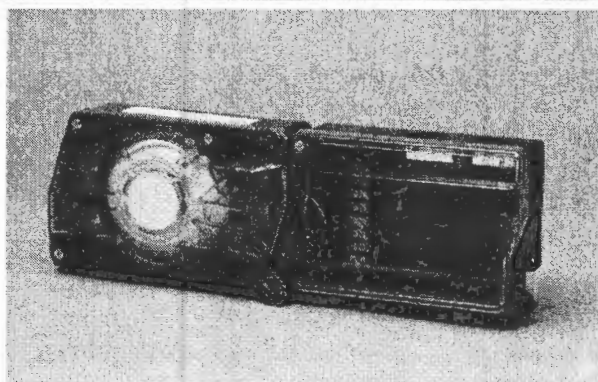

Specifications

Size: (Rectangle) 14.38 in (37 cm) Length; 5 in (12.7 cm) Width, 2.5 in (6.6 cm) Depth

Size: (Square) 7.75 in (19.7 cm) Length; 9 in (22.9 cm) Width; 2.5 in (6.35 cm) Depth

Weight: 1.6 lb (0.73 kg)

Operating Temperature Range: -4 degrees F to 158 degrees F (-20 degrees C to 70 degrees C)

Storage Temperature Range: -22 degrees F to 158 degrees F (-30 degrees C to 70 degrees C)

Operating Humidity Range: 0% to 95% relative humidity (non-condensing)

Air Duct Velocity: 100 to 4,000 ft/min (0.5 to 20.32 m/s)

Accessories

Notifier provides system flexibility with a variety of accessories, including two remote test stations and different means of visible and audible system annunciation. As with our duct smoke detectors, all duct smoke detectors accessories are UL listed.

DNR(W)s with a date code of 0013 or higher do not require external 24VDC for remote test applications when used with a remote-test-capable detector.

ACCESSORY CURRENT LOADS AT 24 VDC

Device	Standby	Alarm
RA100Z	0mA	12 mA Max
RTS151/ RTS151KEY	0mA	12mA Max

Agency Listings and Approvals

Consult product manual for lists of compatible UL-Listed devices. In some cases, certain modules may not be listed by certain approval agencies, or listing may be in process. Consult factory for latest listing status.

- UL Listed: S911
- ULC Listed: S911
- CFSM Listed: 3242-1653:209

Product Line Information

NOTE: "A or "CDN" suffix indicates ULC listed model.

DNR(A): Intelligent non-relay photoelectric low flow smoke detector housing. Requires photoelectric smoke detector (sold separately).

DNRW: Watertight intelligent non-relay photoelectric low flow duct smoke detector housing. Requires photoelectric smoke detector (sold separately). NEMA-4.

FSP-851: Addressable low-profile photoelectric smoke detector.

FSP-851R: Remote test capable addressable low-profile photoelectric smoke detector.

NP-100: Addressable low-profile photoelectric smoke detector for FireWarden series panels.

NP-100R: Remote test capable addressable low-profile photoelectric smoke detector for FireWarden series panels.

DCOIL: Remote test coil. Required for older DNR(W) duct detector housing.

DST1(A): Metal sampling tube duct width up to 1 ft (0.3m)

DST1.5(A): Metal sampling tube duct widths up to 1 ft to 2 ft (0.3 to 0.6 m)

DST3(A): Metal sampling tube duct widths up to 2 ft to 4 ft (0.6 to 1.2 m)

DST5(A): Metal sampling tube duct widths up to 4 ft to 8 ft (1.2 to 2.4 m)

DST10(A): Metal sampling tube duct widths up to 8 ft to 12 ft (2.4 to 3.7 m)

DH400OE-1: Weatherproof enclosure

ETX: Metal exhaust tube duct, width 1 ft (0.3 m)

M02-04-00: Test magnet

P48-21-00: End cap for metal sampling tubes

RA100Z(A): Remote annunciator alarm LED

RTS151(A): Remote test station

RTS151KEY(A): Remote test station with key lock

Important Note

- DNRW duct detector housings with a date code of 0013 or higher do not require a DCOIL or auxiliary 24 VDC for remote test applications when used with a remote test capable detector.
- DNRW duct detector housings with a date code of 0012 or earlier require a DCOIL and auxiliary 24 VDC power for remote test applications.

ONYX® and NOTIFIER® are registered trademarks and NOTI-FIRE-NET™ is a trademark of Honeywell International Inc.

©2010 by Honeywell International Inc. All rights reserved. Unauthorized use of this document is strictly prohibited.



This document is not intended to be used for installation purposes.
We try to keep our product information up-to-date and accurate.
We cannot cover all specific applications or anticipate all requirements.
All specifications are subject to change without notice.



Made in the U.S. A.

For more information, contact Notifier. Phone: (203) 484-7161, FAX: (203) 484-7118.
www.notifier.com

Duct Smoke Detector Accessories

for Notifier/System Sensor Products



Miscellaneous

General

Duct smoke detector accessories add functionality to the duct smoke system by allowing quick, convenient inspections at eye level and effective audible and visual notification options. All System Sensor duct smoke detectors and accessories are UL listed.

Specifications

APA151 PIEZO ANNUNCIATOR

The APA151 piezo annunciator, which replaces the APA451 with a new, improved look, provides an audible alarm signal, a red LED to indicate alarm status, and a green LED to indicate power status. It is intended for use with System Sensor 4-wire conventional duct smoke detector applications without a system control panel, to comply with NFPA 90A.



APA151.wmf

APA151 Piezo Annunciator	
Voltage	Regulated 24 VDC
Operating Voltage	16 to 33 VDC
Maximum Alarm Current	30 mA
Temperature Range	32°F to 120°F (0°C to 49°C)
Relative Humidity	10 to 93%, non-condensing
Wire Gauge	12 to 18 AWG
Dimensions	4.6" H x 2.9" W x .45" D

MHR/MHW MINI-HORNS

The MHR and MHW SpectrAlert® Advance mini-horns feature temporal or continuous tones at high and low volume settings. Their small footprint allows mounting to single-gang back boxes for applications where a small device is desired.



MHR.wmf, MHW.wmf

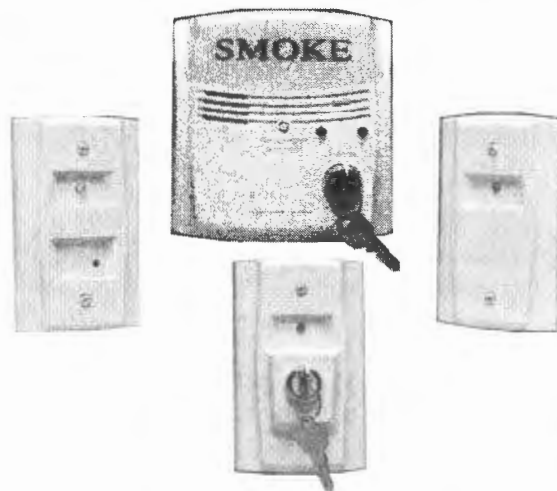

60535cov.wmf

MHR/MHW SpectrAlert Advance Mini-Horns	
Voltage	Regulated 12 DC or FWR (Full Wave Rectified) or Regulated 24 VDC or FWR
Operating Voltage	8 to 33 VDC (9 to 33 VDC with Sync-Circuit™ Module)
Sounder Current Draw	22 mA RMS max. at 8 to 17.5 Volts DC 17 mA RMS max. at 8 to 17.5 Volts FWR 29 mA RMS max. at 16 to 33 Volts DC 25 mA RMS max. at 16 to 33 Volts FWR
Temperature Range	32°F to 120°F (0°C to 49°C)
Humidity Range	10 to 93% non-condensing
Nominal Sounder Frequency	3 kHz
Wire Gauge	12 to 18 AWG
Dimensions	4.6" H x 2.9" W x 0.45" D

RA100Z/RA100ZA REMOTE ANNUNCIATORS

The RA100Z and RA100ZA remote annunciators are designed for both conventional and intelligent applications. Their red LED provides visual indication of an alarm condition.

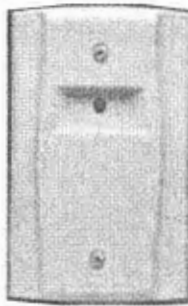

RA100Z.wmf

RA100Z/RA100ZA Remote Annunciator	
Voltage Range	Conventional System: 3.1 to 32 VDC Intelligent System: 18 to 32 VDC
Maximum Alarm Current	10 mA
Dimensions	4.6"H x 2.8"W x 1.3"D

RTS151/RTS151KEY REMOTE TEST STATIONS

The RTS151 and RTS151KEY remote test stations are automatic fire detector accessories designed to test duct smoke detectors from a convenient location. For 4-wire detectors, the RTS151KEY test station features a multi-colored LED that alternates between steady green and red. For 2-wire detectors, the LED illuminates red for alarm.

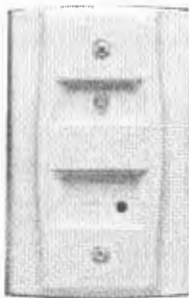

RTS151.wmf, RTS151KEY.wmf

RTS151 Remote Test Station	
Power Requirements	Alarm LED 2.8 to 32 VDC, 10 mA max. Total Current: 95 mA max.
Test Switch	10 VA @ 32 VDC
Reset Switch	10 VA @ 32 VDC
Alarm Response Time	40 seconds max.
Temperature Range	14°F to 140°F (-10°C to 60°C)
Relative Humidity	95% non-condensing
Wire Gauge	14 to 18 AWG
Dimensions	4.8"H x 2.9"W x 1.4"D

RTS151KEY Remote Test Station with Key	
Power Requirements	Power LED (Green): 14 to 35 VDC, 12 mA max. Alarm LED (RED): 2.8 to 32 VDC, 12 mA max.
Alarm Response Time	40 seconds max.
Temperature Range	14°F to 140°F (-10°C to 60°C)
Relative Humidity	95% non-condensing
Wire Gauge	14 to 18 AWG
Dimensions	4.6"H x 2.75"W x 1.8"D

RTS2/RTS-AOS MULTI-SIGNALLING ACCESSORIES

The RTS2 and RTS2-AOS multi-signalling accessories are designed to work with InnovairFlex 4-wire conventional duct smoke detectors. These accessories include a key switch that can be used to select one of two connected sensors to be tested, reset, or both by a push button switch. They also enable sensitivity measurements using the SENS-RDR sensitivity reader (sold separately). The AOS (Add-On Strobe) is an optional accessory included with the RTS2-AOS model.

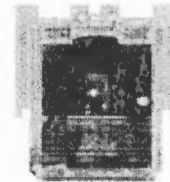

RTS.AOS.wmf, AOS.wmf

RTS2 and RTS-AOS Multi-signalling Accessory	
Voltage	20 to 29 VDC
Power Requirements	Standby: 3.0 mA max. Trouble: 16.0 mA max. Alarm without Strobe: 30 mA max. Alarm with Strobe: 55 mA max.
Sounder	85 dBA at 10 ft.
Temperature Range	14°F to 140°F (-10°C to 60°C)
Relative Humidity	95% non-condensing
Wire Gauge	14 to 22 AWG
Dimensions	4.8"W x 5.3"H x 1.6"D

Product Line Information

APA151: Piezo Annunciator

MHR: Mini-Horn, Red

MHW: Mini-Horn, White

RA100Z/RA100ZA: Remote Annunciator

RTS151: Remote Test Station

RTS151KEY: Remote Test Station with Key

RTS2: Multi-signaling Accessory

AOS: Add-On Strobe

RTS2-AOS: Multi-Signaling Accessory

Temperature and Humidity Ranges

This system meets NFPA requirements for operation at 0 – 49°C/32 – 120°F and at a relative humidity 93% ± 2% RH (noncondensing) at 32°C ± 2°C (90°F ± 3°F). However, the useful life of the system's standby batteries and the electronic components may be adversely affected by extreme temperature ranges and humidity. Therefore, it is recommended that this system and its peripherals be installed in an environment with a normal room temperature of 15 – 27°C/60 – 80°F.

Agency Listings and Approvals

The listings and approvals below apply to the basic products. In some cases, certain modules may not be listed by certain approval agencies, or listing may be in process. Consult factory for latest listing status.

- **UL: S4011**
- **FM Approved**
- **CSFM: 7135-1653:196**

FlashScan®, NOTIFIER® and System Sensor® are registered trademarks of Honeywell International Inc.
©2009 by Honeywell International Inc. All rights reserved. Unauthorized use of this document is strictly prohibited.

ISO 9001
CERTIFIED
ENGINEERING & MANUFACTURING
QUALITY SYSTEMS

This document is not intended to be used for installation purposes.
We try to keep our product information up-to-date and accurate.
We cannot cover all specific applications or anticipate all requirements.
All specifications are subject to change without notice.



Made in the U.S. A.

For more information, contact Notifier. Phone: (203) 484-7161, FAX: (203) 484-7118.
www.notifier.com

NC-100R(A)

Relay Module for FireWarden Series Panels



Addressable

General

The NC-100R(A) Addressable Relay Module provides NOTIFIER's FireWarden Series intelligent control panels with two isolated sets of Form-C dry-contact outputs for activating a variety of auxiliary devices, such as fans, dampers, door holders, control equipment, etc. Addressability allows the dry contact to be activated, either manually or through panel programming, on a select basis.

Features

- Built-in type identification automatically identifies these devices to the control panel.
- Internal circuitry and relay powered directly by two-wire SLC loop.
- Integral LED "blinks" green each time a communication is received from the control panel and turns on in steady when activated.
- High noise immunity (EMF/RFI).
- Wide viewing angle of LED.
- SEMS screws with clamping plates for wiring ease.
- Direct Decade entry of address: 01 – 99 with the FireWarden-100-2(C) and 01 – 50 with the FireWarden-50(C).

Applications

The NC-100R(A) may be programmed to operate dry contacts for door holders, Air Handling Unit shutdown, etc., and to reset four-wire smoke detector power.

Construction

- The face plate is made of off-white heat-resistant plastic.
- Controls include two rotary switches for direct-dial entry of address setting.
- The NC-100R(A) provides two Form-C dry contacts that switch together.

Operation

Each NC-100R(A) uses one of the addresses on a SLC loop. It responds to regular polls from the control panel and reports its type and status. The LED blinks with each poll received. On command, it activates its internal relay.

Rotary switches set a unique address for each module. The address may be set before or after mounting. The built-in TYPE CODE (not settable) will identify the module to the control panel.

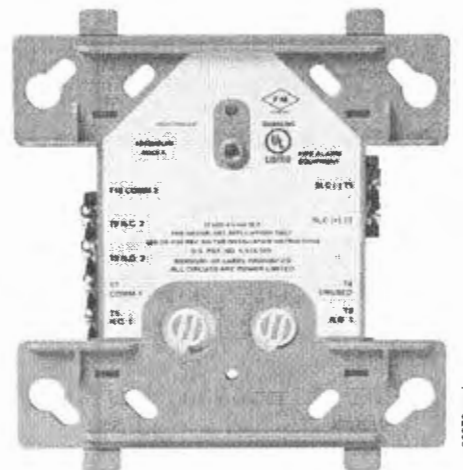

NC-100R(A)

Specifications

Normal operating voltage: 15 to 32 VDC.

Maximum SLC current draw: 6.5 mA (LED).

Average operating current: 230 μ A direct poll (CLIP mode), 255 μ A group poll with LED flashing.

EOL resistance: not used.

Temperature range: 32°F to 120°F (0°C to 49°C).

Humidity range: 10% to 93% non-condensing.

Dimensions: 4.5" (11.43 cm) high x 4" (10.16 cm) wide x 1.25" (3.175 cm) deep. Mounts to a 4" (10.16 cm) square x 2.125" (5.398 mm) deep box.

Relay Contact Ratings

Load Description	Application	Maximum Voltage	Current Rating
Resistive	Non-Coded	30 VDC	3.0 A
Resistive	Coded	30 VDC	2.0 A
Resistive	Non-Coded	110 VDC	0.9 A
Resistive	Non-Coded	125 VAC	0.9 A
Inductive (L/R=5ms)	Coded	30 VDC	0.5 A
Inductive (L/R=2ms)	Coded	30 VDC	1.0 A
Inductive (PF=0.35)	Non-Coded	125 VAC	0.5 A

Agency Listings and Approvals

In some cases, certain modules may not be listed by certain approval agencies, or listing may be in process. Consult factory for latest listing status.

- **UL/ULC Listed:** S635.
- **CSFM approved:** file 7300-0028:230.
- **FM approved.**
- **MEA approved:** file 72-01-E, Vol. 2.

Product Line Information

NC-100R: Intelligent addressable relay module.

NC-100RA: Intelligent addressable relay module, ULC listed model.

SMB500: Optional surface-mount backbox.

NOTE: For installation instructions, see document I56-2593-001 and refer to the SLC Wiring Manual, document 52304.

NOTIFIER® is a registered trademark of Honeywell International Inc.
©2010 by Honeywell International Inc. All rights reserved. Unauthorized use of this document is strictly prohibited.



This document is not intended to be used for installation purposes.
We try to keep our product information up-to-date and accurate.
We cannot cover all specific applications or anticipate all requirements.
All specifications are subject to change without notice.



Made in the U.S. A.

For more information, contact Notifier. Phone: (203) 484-7161, FAX: (203) 484-7118.
www.notifier.com

Monitor Modules

NMM-100(A), NMM-100P(A), NZM-100(A), and NDM-100(A) for FireWarden Series Panels

dn-6999:b1



Intelligent Addressable Devices

General

Four different monitor modules are available for Notifier's FireWarden Series intelligent control panels for a variety of applications. Monitor modules supervise a circuit of dry-contact input devices, such as conventional heat detectors and pull stations, or monitor and power a circuit of two-wire smoke detectors (NZM-100(A)).

NMM-100(A) is a standard-sized module (typically mounts to a 4" [10.16 cm] square box) that supervises either a Style D (Class A) or Style B (Class B) circuit of dry-contact input devices.

NMM-100P(A) is a miniature monitor module a mere 1.3" (3.302 cm) H x 2.75" (6.985 cm) W x 0.5" (1.270 cm) D that supervises a Style B (Class B) circuit of dry-contact input devices. Its compact design allows the NMM-100P(A) to often be mounted in a single-gang box behind the device it monitors.

NZM-100(A) is a standard-sized module that monitors and supervises compatible two-wire, 24 volt, smoke detectors on a Style D (Class A) or Style B (Class B) circuit.

NDM-100(A) is a standard-sized dual monitor module that monitors and supervises two independent two-wire Style B (Class B) dry-contact initiating device circuits (IDCs) at two separate, consecutive addresses in intelligent, two-wire systems.

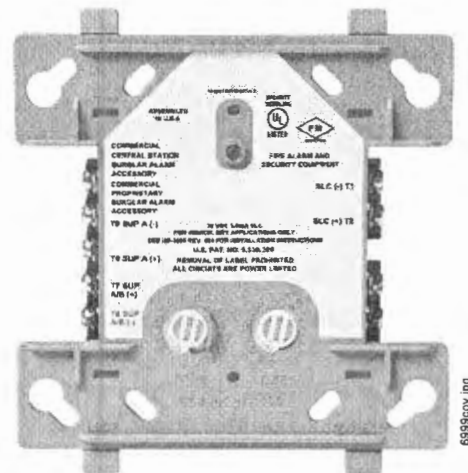

NMM-100(A) (Type H)

NMM-100(A) Monitor Module

- Built-in type identification automatically identifies this device as a monitor module to the control panel.
- Powered directly by two-wire SLC loop. No additional power required.
- High noise (EMF/RFI) immunity.
- SEMS screws with clamping plates for ease of wiring.
- Direct Decade entry of address: 01 – 99 on FireWarden-100-2, 01 – 50 on FireWarden-50.
- LED flashes during normal operation and latches on steady to indicate alarm.

The NMM-100(A) Monitor Module is intended for use in intelligent, two-wire systems, where the individual address of each module is selected using the built-in rotary switches. It provides either a two-wire or four-wire fault-tolerant Initiating Device Circuit (IDC) for normally-open-contact fire alarm and supervisory devices. The module has a panel-controlled LED indicator.

NMM-100(A) APPLICATIONS

Use to monitor a zone of four-wire smoke detectors, manual fire alarm pull stations, waterflow devices, or other normally-open dry-contact alarm activation devices. May also be used to monitor normally-open supervisory devices with special supervisory indication at the control panel. Monitored circuit may be wired as an NFPA Style B (Class B) or Style D (Class A) Initiating Device Circuit. A 47K ohm End-of-Line Resistor (provided) terminates the Style B circuit. No resistor is required for supervision of the Style D circuit.

NMM-100(A) OPERATION

Each NMM-100(A) uses one of the available module addresses on an SLC loop. It responds to regular polls from the control panel and reports its type and the status (open/normal/short) of its Initiating Device Circuit (IDC). A flashing LED indicates that the module is in communication with the control panel. The LED latches steady on alarm (subject to current limitations on the loop).

NMM-100(A) SPECIFICATIONS

Nominal operating voltage: 15 to 32 VDC.

Maximum current draw: 5.0 mA (LED on).

Average operating current: 350 μ A (LED flashing), 1 communication every 5 seconds, 47k EOL.

Maximum IDC wiring resistance: 40 ohms.

EOL resistance: 47K ohms.

Temperature range: 32°F to 120°F (0°C to 49°C).

Humidity range: 10% to 93% noncondensing.

Dimensions: 4.5" (11.43 cm) high x 4" (10.16 cm) wide x 1.25" (3.175 cm) deep. Mounts to a 4" (10.16 cm) square x 2.125" (5.398 cm) deep box.

NMM-100P(A) Mini Monitor Module

- Built-in type identification automatically identifies this device as a monitor module to the panel.
- Powered directly by two-wire SLC loop. No additional power required.
- High noise (EMF/RFI) immunity.
- Tinned, stripped leads for ease of wiring.
- Direct Decade entry of address: 01 – 99 on FireWarden-100-2, 01 – 50 on FireWarden-50.

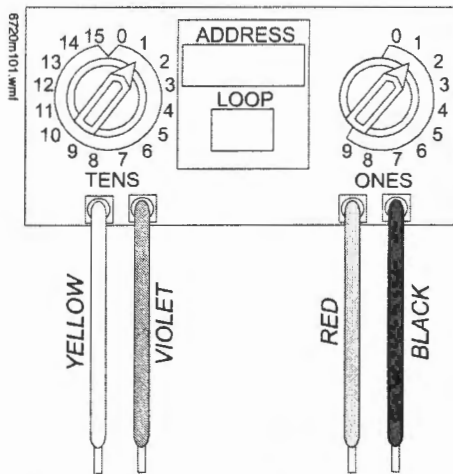

The NMM-100P(A) Mini Monitor Module can be installed in a single-gang junction directly behind the monitored unit. Its small size and light weight allow it to be installed without rigid mounting. The NMM-100P(A) is intended for use in intelligent, two-wire systems where the individual address of each module is selected using rotary switches. It provides a two-wire initiating device circuit for normally-open-contact fire alarm and security devices. NMM-100P(A)

NMM-100P(A) APPLICATIONS

Use to monitor a single device or a zone of four-wire smoke detectors, manual fire alarm pull stations, waterflow devices, or other normally-open dry-contact devices. May also be used to monitor normally-open supervisory devices with special supervisory indication at the control panel. Monitored circuit/device is wired as an NFPA Style B (Class B) Initiating Device Circuit. A 47K ohm End-of-Line Resistor (provided) terminates the circuit.

NMM-100P(A) OPERATION

Each NMM-100P(A) uses one of the available module addresses on an SLC loop. It responds to regular polls from the control panel and reports its type and the status (open/normal/short) of its Initiating Device Circuit (IDC).

NMM-100P(A) SPECIFICATIONS

Nominal operating voltage: 15 to 32 VDC.

Average operating current: 350 μ A, 1 communication every 5 seconds, 47k EOL; 600 μ A Max. (Communicating, IDC Shorted).

Maximum IDC wiring resistance: 40 ohms.

Maximum IDC Voltage: 11 Volts.

Maximum IDC Current: 400 μ A.

EOL resistance: 47K ohms.

Temperature range: 32°F to 120°F (0°C to 49°C).

Humidity range: 10% to 93% noncondensing.

Dimensions: 1.3" (3.302 cm) high x 2.75" (6.985 cm) wide x 0.65" (1.651 cm) deep.

Wire length: 6" (15.24 cm) minimum.

NZM-100(A) Interface Module

- Supports compatible two-wire smoke detectors.
- Supervises IDC wiring and connection of external power source.
- High noise (EMF/RFI) immunity.
- SEMS screws with clamping plates for ease of wiring.

- Direct Decade entry of address: 01 – 99 on FireWarden-100-2, 01 – 50 on FireWarden-50.
- LED flashes during normal operation.
- LED latches steady to indicate alarm on command from control panel.

The NZM-100(A) Interface Module is intended for use in intelligent, addressable systems, where the individual address of each module is selected using built-in rotary switches. This module allows intelligent panels to interface and monitor two-wire conventional smoke detectors. It transmits the status (normal, open, or alarm) of one full zone of conventional detectors back to the control panel. All two-wire detectors being monitored must be UL compatible with the module.

NZM-100(A) APPLICATIONS

Use the NZM-100(A) to monitor a zone of two-wire smoke detectors. The monitored circuit may be wired as an NFPA Style B (Class B) or Style D (Class A) Initiating Device Circuit. A 3.9 K ohm End-of-Line Resistor (provided) terminates the end of the Style B or D (class B or A) circuit (maximum IDC loop resistance is 25 ohms). Install ELR across terminals 8 and 9 for Style D application.

NZM-100(A) OPERATION

Each NZM-100(A) uses one of the available module addresses on an SLC loop. It responds to regular polls from the control panel and reports its type and the status (open/normal/short) of its Initiating Device Circuit (IDC). A flashing LED indicates that the module is in communication with the control panel. The LED latches steady on alarm (subject to current limitations on the loop).

NZM-100(A) SPECIFICATIONS

Nominal operating voltage: 15 to 32 VDC.

Maximum current draw: 5.1 mA (LED on).

Maximum IDC wiring resistance: 25 ohms.

Average operating current: 300 μ A, 1 communication and 1 LED flash every 5 seconds, 3.9k eol.

EOL resistance: 3.9K ohms.

External supply voltage (between Terminals T3 and T4): DC voltage: 24 volts power limited. Ripple voltage: 0.1 Vrms maximum. Current: 90 mA per module maximum.

Temperature range: 32°F to 120°F (0°C to 49°C).

Humidity range: 10% to 93% noncondensing.

Dimensions: 4.5" (11.43 cm) high x 4" (10.16 cm) wide x 1.25" (3.175 cm) deep. Mounts to a 4" (10.16 cm) square x 2.125" (5.398 cm) deep box.

NDM-100(A) Dual Monitor Module

The NDM-100(A) Dual Monitor Module is intended for use in intelligent, two-wire systems. It provides two independent two-wire initiating device circuits (IDCs) at two separate, consecutive addresses. It is capable of monitoring normally open contact fire alarm and supervisory devices. The module has a single panel-controlled LED.

NOTE: The NDM-100(A) provides two Style B (Class B) IDC circuits ONLY. Style D (Class A) IDC circuits are NOT supported in any application.

NDM-100(A) SPECIFICATIONS

Normal operating voltage range: 15 to 32 VDC.

Maximum current draw: 6.4 mA (LED on).

Average operating current: 750 μ A (LED flashing).

Maximum IDC wiring resistance: 1,500 ohms.

Maximum IDC Voltage: 11 Volts.

Maximum IDC Current: 240 μ A

EOL resistance: 47K ohms.

Maximum SLC Wiring resistance: 40 Ohms.

Temperature range: 32° to 120°F (0° to 49°C).

Humidity range: 10% to 93% (non-condensing).

Dimensions: 4.5" (11.43 cm) high x 4" (10.16 cm) wide x 2.125" (5.398 cm) deep.

NDM-100(A) AUTOMATIC ADDRESSING

The NDM-100(A) automatically assigns itself to two addressable points, starting with the original address. For example, if the NDM-100(A) is set to address "26", then it will automatically assign itself to addresses "26" and "27".

NOTE: "Ones" addresses on the NDM-100(A) are 0, 2, 4, 6, or 8 only. Terminals 6 and 7 use the first address, and terminals 8 and 9 use the second address.



CAUTION:

Avoid duplicating addresses on the system.

Installation

NMM-100(A), NZM-100(A), and NDM-100(A) modules mount directly to a standard 4" (10.16 cm) square, 2.125" (5.398 cm) deep, electrical box. They may also be mounted to the SMB500 surface-mount box. Mounting hardware and installation instructions are provided with each module. All wiring must conform to applicable local codes, ordinances, and regulations. These modules are intended for power-limited wiring only.

The NMM-100P(A) module is intended to be wired and mounted without rigid connections inside a standard electrical box. All wiring must conform to applicable local codes, ordinances, and regulations.

Agency Listings and Approvals

In some cases, certain modules may not be listed by certain approval agencies, or listing may be in process. Consult factory for latest listing status.

- **UL:** S635
- **ULC:** S635
- **FM Approved**
- **CSFM:** 7300-0028:230 (NMM-100, NMM-100P, NZM-100); 7300-0028:237 (NDM-100)
- **MEA:** 72-01-E Vol. 2 (NMM-100, NMM-100P, NZM-100); 227-03-E Vol. 3 (NDM-100)

Product Line Information

NOTE: "A" or suffix indicates ULC-listed model.

NMM-100(A): Monitor module.

NMM-100P(A): Monitor module, miniature.

NZM-100(A): Monitor module, two-wire detectors.

NDM-100(A): Monitor module, dual, two independent Class B circuits.

SMB500: Optional surface-mount backbox.

NOTE: See installation instructions and refer to the SLC Wiring Manual, PN 52304.

Notifier® and FireWarden® are registered trademarks and FireWatch™ is a trademark of Honeywell International Inc.
©2009 by Honeywell International Inc. All rights reserved. Unauthorized use of this document is strictly prohibited.



This document is not intended to be used for installation purposes.
We try to keep our product information up-to-date and accurate.
We cannot cover all specific applications or anticipate all requirements.
All specifications are subject to change without notice.



Made in the U.S. A.

For more information, contact Notifier. Phone: (203) 484-7161, FAX: (203) 484-7118.
www.notifier.com

FCPS-24S6(C/E) & FCPS-24S8(C/E)

6- & 8-Amp 24-Volt Remote Power Supplies

 **NOTIFIER**[®]
by Honeywell

Power Supplies

General

The FCPS-24S6E (6-amp) and FCPS-24S8E (8-amp) are remote power supplies with battery charger. The FCPS-24S6/-24S8 may be connected to any 12 or 24 volt fire alarm control panel (FACP) or may be used as stand-alone supplies. Primary applications include notification appliance (bell) circuit (NAC) expansion (to support ADA requirements and NAC synchronization) or auxiliary power to support 24 volt system accessories. The FCPS-24S6/-24S8 provides regulated and filtered 24 VDC power to four notification appliance circuits configured as either four Class B (Style Y) or Class A (Style Z, with ZNAC-4 option module). Alternately, the four outputs may be configured as all non-resettable, all resettable or two non-resettable and two resettable. The FCPS-24S6/-24S8 also contains a battery charger capable of charging up to 18 AH batteries. FCPS-24S6C & FCPS-24S8C are ULC-listed.

NOTE: Unless otherwise specified, the terms FCPS-24S6 and FCPS-24S8 used in this document refers to the standard FCPS-24S6 and FCPS-24S8, FCPS-24S6C and FCPS-24S8C, the FCPS-24S6E and FCPS-24S8E

Features

- UL-Listed NAC synchronization using System Sensor, Wheelock, or Gentex "Commander²" appliances.
- Operates as a "sync-follower" or as a "sync-generator" (default). See note on page 2.
- Contains two fully-isolated input/control circuits - triggered from FACP NAC (NAC expander mode) or jumped permanently "ON" (stand-alone mode).
- Four Class B (Style Y) or four Class A (Style Z, with ZNAC-4 module) NACs.
- 6-amp (FCPS-24S6) or 8-amp (FCPS-24S8) full load output, with 3 amps maximum/circuit, in NAC expander mode (UL 864).
- 4-amp (FCPS-24S6) or 6-amp (FCPS-24S8) continuous output in stand-alone mode (UL 1481).
- Compatible with coded inputs; signals passed through.
- Optional power-supervision relay (EOLR-1).
- In stand-alone mode, output power circuits may be configured as: resettable, (reset line from FACP required), non-resettable, or a mix of two and two.
- Fully regulated and filtered power output - optimal for powering four-wire smoke detectors, annunciators, and other system peripherals requiring regulated/filtered power.
- Power-limiting technology meets UL power-limiting requirements.
- Form-C normally-closed trouble relay.
- Fully supervised power supply, battery, and NACs.
- Selectable earth fault detection.
- AC trouble report selectable for immediate 2-hour delay.
- Works with virtually any UL 864 fire alarm control which utilizes an industry-standard reverse-polarity notification circuit (including unfiltered and unregulated bell power).
- Requires input trigger voltage of 9 - 32 VDC.
- Self-contained in compact, locking cabinet - 15"H x 14.5"W x 2.75"D (cm: 38.1H x 36.83W x 6.985D).

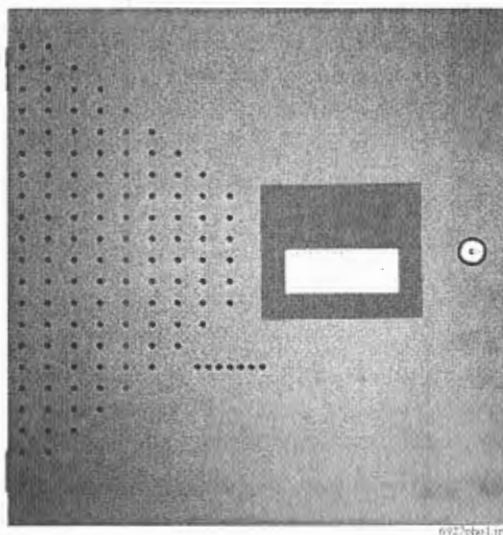

- Includes integral battery charger capable of charging up to 18 AH batteries. Cabinet capable of housing 7.0 AH batteries.
- Battery charger may be disabled via DIP switch for applications requiring larger batteries.
- Fixed, clamp-type terminal blocks accommodate up to 12 AWG (3.1mm²) wire.

Specifications

Primary (AC) Power:

- FCPS-24S6C/-24S8C: 120 VAC, 60 Hz, 3.2A maximum.
- FCPS-24S6E/-24S8E: 240 VAC, 50 Hz, 1.6A maximum.
- Wire Size: minimum #14 AWG (2.0mm²) with 600 V insulation.

Control Input Circuit:

- **Trigger Input Voltage:** 9 to 32 VDC.
- **Trigger Current:** 2.0 mA (16 - 32 V); Per Input: 1.0 mA (9 - 16 V).

Trouble Contact Rating: 5 A at 24 VDC.

Auxiliary Power Output: Specific application power 500 mA maximum.

Output Circuits:

- +24 VDC filtered, regulated.
- 3.0 A maximum for any one circuit.
- Total continuous current for all outputs (stand-alone mode):
 - FCPS-24S6: 4.0 A maximum.
 - FCPS-24S8: 6.0 A maximum.
- Total short-term current for all outputs (NAC expander mode):
 - FCPS-24S6: 6.0 A maximum.
 - FCPS-24S8: 8.0 A maximum.

Secondary Power (Battery) Charging Circuit:

- Supports lead-acid batteries only.
- Float-charge voltage: 27.6 VDC.

- Maximum current charge: 1.5 A.
- Maximum battery capacity: 18 AH.

Applications

Example 1: Expand notification appliance power an additional 6.0 A (FCPS-24S6) or 8.0 A (FCPS-24S8). Use up to four Class B (Style Y) outputs or four Class A (Style Z) outputs (using ZNAC-4). For example, the FACP notification appliance circuits will activate the FCPS when reverse-polarity activation occurs. Trouble conditions on the FCPS are sensed by the FACP through the notification appliance circuit.

Example 2: Use the FCPS to expand auxiliary regulated 24-volt system power up to 4.0 A (FCPS-24S6) or up to 6.0 A (FCPS-24S8). Both resettable and non-resettable power options are available. Resettable outputs are created by connecting the resettable output from the FACP to one or both of the FCPS inputs.

Example 3: Use addressable control modules to activate the FCPS instead of activating it through the FACP notification appliance circuits. This typically allows for mounting the FCPS at greater distances* away from the FACP while expanding system architecture in various applications.

For example, an addressable control module is used to activate the FCPS, and an addressable monitor module is used to sense FCPS trouble conditions. Local auxiliary power output from the FCPS provides power to the addressable control module.

***NOTE:** Addressable FACPs are capable of locating control and monitor modules at distances of up to 12,500 feet (3,810 meters).

Sync Follower/Generator Note

In some installations, it is necessary to synchronize the flash timing of all strobes in the system for ADA compliance. Strobes accomplish this by monitoring very short timing pulses on the NAC power which are created by the FACP. When installed at the end of a NAC wire run, the FCPS-24S6/-24S8 can track (i.e. "follow") the strobe synchronization timing pulses on the existing NAC wire run. This maintains the overall system flash timing of the additional strobes attaches to the FCPS.

When the FCPS-24S6/-24S8 is configured (via DIP switch settings) as a "sync follower," the FCPS's NAC outputs track the strobe synchronization pulses present at the FCPS's sync input terminal. The pulses originate from an upstream FACP or other power supply.

When the FCPS-24S6/-24S8 are configured (via DIP switch settings) as a "sync generator," the FCPS's sync input terminals are not used. Rather, the FCPS is the originator of the strobe synchronization pulses on the FCPS's NAC outputs. In "sync generator" mode, the sync type (System Sensor, Wheelock, or Gentex) is selectable via DIP switch settings.

Standards and Codes

The FCPS-24S6 and FCPS-24S8 comply with the following standards:

- **NFPA 72** National Fire Alarm Code.
- **UL 864** Standard for Control Units for Fire Alarm Systems (NAC expander mode).
- **UL 1481** Power Supplies for Fire Alarm Systems.

Agency Listings and Approvals

These listings and approvals apply to the modules specified in this document. In some cases, certain modules or applications may not be listed by certain approval agencies, or listing may be in process. Consult factory for latest listing status.

- **UL Listed:** S635, S674
- **ULC Listed:** S635 (FCPS-24S6C & FCPS-24S8C)
- **CSFM Approved:** 7315-0028:225
- **MEA:** 299-02-E
- **FM Approved**

Ordering Information

FCPS-24S6: 6.0 A, 120 VAC remote charger power supply. Includes main printed circuit board, transformers, enclosure (15"H x 14.5"W x 2.75"D [cm: 38.1H x 36.83W x 6.985D]), and installation instructions.

FCPS-24S6C: Same as above, ULC-listed.

FCPS-24S6R: Same as FCPS-24S6 with red enclosure.

FCPS-24S6E: 6.0 A, 240 VAC remote charger power supply. Includes main printed circuit board, transformers, enclosure (15"H x 14.5"W x 2.75"D [cm: 38.1H x 36.83W x 6.985D]), and installation instructions.

FCPS-24S8: 8.0 A, 120 VAC remote charger power supply. Includes main printed circuit board, transformers, enclosure (15"H x 14.5"W x 2.75"D [cm: 38.1H x 36.83W x 6.985D]), and installation instructions.

FCPS-24S8C Same as above, ULC-listed.

FCPS-24S8R: Same as FCPS-24S8 with red enclosure.

FCPS-24S8E: 8.0 A, 240 VAC remote charger power supply. Includes main printed circuit board, transformers, enclosure (15"H x 14.5"W x 2.75"D [cm: 38.1H x 36.83W x 6.985D]), and installation instructions.

ZNAC-4: Class A (Style Y) NAC option module.

EOLR-1: 12/24 VDC end-of-line relay for monitoring four-wire smoke detector power.

BAT-1270: Battery, 12-volt, 7.0 AH (two required, see BAT Series data sheet DN-6933).

PS-1270: Battery, 12-volt, 7.0 AH (two required, see PS Series data sheet DN-1109)

System Sensor® and NOTIFIER® are registered trademarks of Honeywell International Inc.
©2009 by Honeywell International Inc. All rights reserved. Unauthorized use of this document is strictly prohibited.



This document is not intended to be used for installation purposes.
We try to keep our product information up-to-date and accurate.
We cannot cover all specific applications or anticipate all requirements.
All specifications are subject to change without notice.



Made in the U.S.A.

For more information, contact Notifier. Phone: (203) 484-7161, FAX: (203) 484-7118.
www.notifier.com

EXCEDER™

Finally, Design and Safety Meet...



Description:

The Wheelock® Exceder™ Series of notification appliances feature a sleek modern design that will please building owners with reduced total cost of ownership. Installers will benefit from its comprehensive feature list, including the most candela options in one appliance, low current draw, no tools needed for setting changes, voltage test points, 12/24 VDC operation, universal mounting base and multiple mounting options for both new and retrofit construction.

The Wheelock® Exceder™ Series incorporates high reliability and high efficiency optics to minimize current draw allowing for a greater number of appliances on the notification appliance circuit. All strobe models feature an industry first of 8 candela settings on a single appliance. Models with an audible feature 3 sound settings (90, 95, 99 dB). All switches to change settings, can be set without the use of a tool and are located behind the appliance to prevent tampering. Wall models feature voltage test points to take readings with a voltage meter for troubleshooting and AHJ inspection.

The Wheelock® Exceder™ Series of wall and ceiling notification appliances feature a Universal Mounting Base (UMB) designed to simplify the installation and testing of horns, strobes, and combination horn strobes. The separate universal mounting base can be pre-wired to allow full testing of circuit wiring before the appliance is installed and the surface is finished. It comes complete with a Contact Cover for protection against dirt, dust, paint and damage to the contacts. The Contact Cover also acts as a shunting device to allow pre-wire testing for common wiring issues. The Contact Cover is polarized to prevent it from being installed incorrectly and prevents the appliance from being installed while it is on the UMB. When the Contact Cover is removed the circuit will show an open until the appliance is installed. The UMB allows for consistent installation and easy replacement of appliances if required. Wall models provide an optional locking screw for extra secure installation, while the ceiling models provide a captivated screw to prevent the screw from falling during installation.

- Save up to **48%** in current draw*
- Up to **9** models now in **1** appliance
- Save up to **14%** cost of installation**

 Sleek Modern Aesthetics

 Finger Slide Switches

 Voltage Test Points

 Multiple Voltages

 3 Audible Settings
90, 95, 99 dB

 8 Candela Settings ***
Wall - 15/1575/30/75/95/110/135/185
Ceiling - 15/30/60/75/95/115/150/177

 Universal Mounting Base ***
Ceiling and Wall
Mounts to 5 Backbox Types

 Environmentally Friendly
Low Current Draw

Compatibility and Requirements

- Synchronize using the Wheelock® Sync Modules or panels with built-in Wheelock® Patented Sync Protocol
- Compatible with UL "Regulated Voltage" using filtered VDC or unfiltered VRMS input voltage
- Strobes produce 1 flash per second over the "Regulated Voltage" range

* Compared to competitive models *** Patented
** Compared to previous models

NOTE: All CAUTIONS and WARNINGS are identified by the symbol ▲. All warnings are printed in bold capital letters.

▲ WARNING: PLEASE READ THESE SPECIFICATIONS AND ASSOCIATED INSTALLATION INSTRUCTIONS CAREFULLY BEFORE USING, SPECIFYING OR APPLYING THIS PRODUCT. VISIT WWW.GOOPERNOTIFICATION.COM OR CONTACT COOPER NOTIFICATION FOR THE CURRENT INSTALLATION INSTRUCTIONS. FAILURE TO COMPLY WITH ANY OF THESE INSTRUCTIONS, CAUTIONS OR WARNINGS COULD RESULT IN IMPROPER APPLICATION, INSTALLATION AND/OR OPERATION OF THESE PRODUCTS IN AN EMERGENCY SITUATION, WHICH COULD RESULT IN PROPERTY DAMAGE, AND SERIOUS INJURY OR DEATH TO YOU AND/OR OTHERS.

General Notes:

General Notes:

- Strobes are designed to flash at 1 flash per second minimum over their "Regulated Voltage Range".
- All candela ratings represent minimum effective strobe intensity based on UL Standard 1971.
- Series Exceder Strobe products are Listed under UL Standards 1971 and 464 for indoor use with a temperature range of 32°F to 120°F (0°C to 49°C) and maximum humidity of 93% (± 2%) UL 464 (85% UL 1971).
- Series Exceder horns are under UL Standard 464 for audible signal appliances (Indoor use only).

Low Current Draw = Fewer Power Supplies

Strobe Ratings per UL Standard 1971

		UL Max Current*													
		24 VDC / 24 FWR												12 VDC	
Model	Regulated Voltage Range VDC	15	15/75	30	60	75	95	110	115	135	150	177	185	15	15/75
ST	8.0-33.0	0.057	0.070	0.085		0.135	0.163	0.182		0.205			0.253	0.110	0.140
STC	8.0-33.0	0.061		0.085	0.103	0.135	0.163		0.182		0.205	0.253		0.110	

Horn Strobe Ratings per UL 1971 & UL 464 at 24 VDC

		UL Max Current* at 99 dBA													
		24 VDC												12 VDC	
Model	Regulated Voltage Range VDC	15	15/75	30	60	75	95	110	115	135	150	177	185	15	15/75
HS	8.0-33.0	0.082	0.095	0.102		0.148	0.176	0.197		0.242			0.282	0.125	0.159
HSC	8.0-33.0	0.082		0.102	0.141	0.148	0.176		0.197		0.242	0.282		0.125	

		UL Max Current* at 95 dBA													
		24 VDC												12 VDC	
Model	Regulated Voltage Range VDC	15	15/75	30	60	75	95	110	115	135	150	177	185	15	15/75
HS	8.0-33.0	0.073	0.083	0.087		0.139	0.163	0.186		0.230			0.272	0.122	0.153
HSC	8.0-33.0	0.073		0.087	0.128	0.139	0.163		0.186		0.230	0.272		0.122	

		UL Max Current* at 90 dBA													
		24 VDC												12 VDC	
Model	Regulated Voltage Range VDC	15	15/75	30	60	75	95	110	115	135	150	177	185	15	15/75
HS	8.0-33.0	0.065	0.075	0.084		0.136	0.157	0.184		0.226			0.267	0.120	0.148
HSC	8.0-33.0	0.065		0.084	0.120	0.136	0.157		0.184		0.226	0.267		0.120	

Horn Ratings per UL 464

Model	Regulated Voltage Range VDC	99 dB	95 dB	90 dB
HN	16-33.0	0.064	0.044	0.022
HNC	16-33.0	0.084	0.044	0.022
HN	8.0-17.5	0.047	0.026	0.017
HNC	8.0-17.5	0.047	0.026	0.017



* UL max current rating is the maximum RMS current within the listed voltage range (16-33 VDC for 24 VDC units). For strobes the UL max current is usually at the minimum listed voltage (16 VDC for 24 VDC units). For audibles the max current is usually at the maximum listed voltage (33 VDC for 24 VDC units). For unfiltered ratings, see installation instructions.

Specification & Ordering Information

Model	Strobe Candela	Sync w/ SM, DSM or PS-6 & PS-8	12/24 VDC*	Mounting Options
Horn Strobes				
HSR	15/1575/30/75/95/110/135/185	X	X	UMB**
HSW	15/1575/30/75/95/110/135/185	X	X	UMB**
HSRC	15/30/60/75/95/115/150/177	X	X	UMB**
HSWC	15/30/60/75/95/115/150/177	X	X	UMB**
Strobes				
STR	15/1575/30/75/95/110/135/185	X	X	UMB**
STW	15/1575/30/75/95/110/135/185	X	X	UMB**
STRC	15/30/60/75/95/115/150/177	X	X	UMB**
STWC	15/30/60/75/95/115/150/177	X	X	UMB**
Horn				
HNR		X	X	UMB**
HNW		X	X	UMB**
HNRC		X	X	UMB**
HNWC		X	X	UMB**

*12 VDC models feature 15 & 15/75 settings

**UMB = Universal Mounting Base

Model Legend

- HN = Horn
- ST = Strobe
- HS = Horn Strobe
- C = Ceiling Mount
- W = White
- R = Red

Example 1: STRC = Strobe, Red, Ceiling Mount
 Example 2: HSR = Horn Strobe, Red, Wall Mount
 Example 3: HSW = Horn Strobe, White, Wall Mount

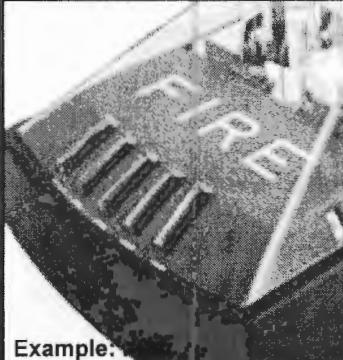

Example: HSWC

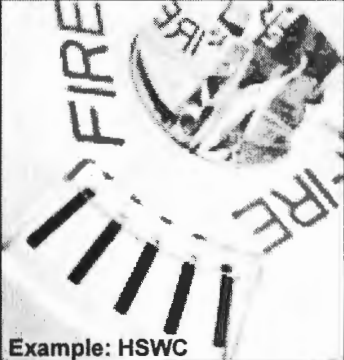

Example: HSWC

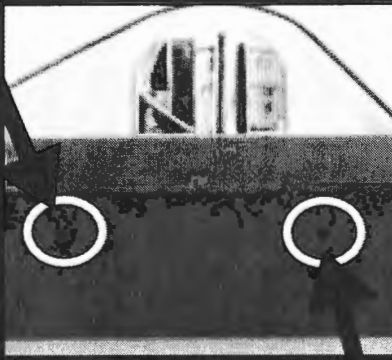

Voltage test points for quick troubleshooting and easy spot checking (wall models only)



8 candela settings

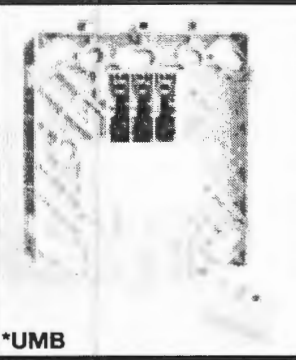

*UMB
Common base for wall and ceiling with 5 mounting options

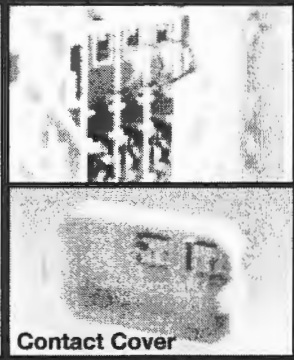

Contact Cover

NOTE: Due to continuous development of our products, specifications and offerings are subject to change without notice in accordance with Cooper Wheelock Inc., dba Cooper Notification standard terms and conditions.

Architects and Engineers Specifications

The notification appliances shall be Wheelock® Exceder™ Series HS Audible Strobe appliances, Series ST Visual Strobe appliances and Series HN Audible appliances or approved equals. The Series HS and ST Strobes shall be listed for UL Standard 1971 (Emergency Devices for the Hearing-Impaired) for Indoor Fire Protection Service. The Series HS and HN Audibles shall be UL Listed under Standard 464 (Fire Protective Signaling). All Series shall meet the requirements of FCC Part 15 Class B. All inputs shall be compatible with standard reverse polarity supervision of circuit wiring by a Fire Alarm Control Panel (FACP) with the ability to operate from 8 to 33 VDC. Indoor wall models shall incorporate voltage test points for easy voltage inspection.

The Series HS Audible Strobe and ST Strobe appliances shall produce a flash rate of one (1) flash per second over the Regulated Voltage Range and shall incorporate a Xenon flashtube enclosed in a rugged Lexan® lens. The Series shall be of low current design. Where Multi-Candela appliances are specified, the strobe intensity shall have 8 field selectable settings at 15, 15/75, 30, 75, 95, 110, 135, 185 candela for wall mount and 15, 30, 60, 75, 95, 115, 150, 177 candela for ceiling mount. The selector switch for selecting the candela shall be tamper resistant. The 15/75 candela strobe shall be specified when 15 candela UL Standard 1971 Listing with 75 candela on-axis is required (e.g. ADA compliance). Appliances with candela settings shall show the candela selection in a visible location at all times when installed.

The audible shall have a minimum of three (3) field selectable settings for dBA levels and shall have a choice of continuous or temporal (Code 3) audible outputs.

The Series HS Audible Strobe, ST Strobe and Series HN Audible shall incorporate a patented Universal Mounting Base that shall allow mounting to a single-gang, double-gang, 4-inch square, 3.5-inch octal, 4-inch octal or 100mm European type back boxes. Two wire appliance wiring shall be capable of directly connecting to the mounting base. Continuity checking of the entire NAC circuit prior to attaching any notification appliances shall be allowed. Product shall come with Contact Cover to protect contact springs. Removal of an appliance shall result in a supervision fault condition by the Fire Alarm Control Panel (FACP). The mounting base shall be the same base among all horn, strobe, horn strobe, wall and ceiling models. All notification appliances shall be backwards compatible.

The Series HS and ST wall models shall have a low profile measuring 5.24" H x 4.58" W x 2.19" D. Series HN wall shall measure 5.24" H x 4.58" W x 1.6" D. The Series HSC and STC shall be round and have a low profile with a diameter of 6.68" x 2.63" D. Series HNC ceiling shall have a diameter of 6.68" x 1.50" D.

When synchronization is required, the appliance shall be compatible with Wheelock®'s SM, DSM Sync Modules, Wheelock® Power Supplies or other manufacturer's panels with built-in Wheelock® Patented Sync Protocol. The strobes shall not drift out of synchronization at any time during operation. If the sync protocol fails to operate, the strobe shall revert to a non-synchronized flash-rate and still maintain (1) flash per second over its Regulated Voltage Range. The appliance shall also be designed so that the audible signal may be silenced while maintaining strobe activation when used with Wheelock® synchronization protocol.

Wall Appliances – UL Standard 1971, UL Standard 464, California State Fire Marshal (CSFM), ULC

Ceiling Appliances – UL Standard 1971, UL Standard 464, California State Fire Marshal (CSFM), ULC



WE ENCOURAGE AND SUPPORT NICET CERTIFICATION
3 YEAR WARRANTY

Exceder - Spec Sheet 11/09

NJ Location

273 Branchport Ave.
Long Branch, NJ 07740
P: 800-631-2148
F: 732-222-8707

www.coopernotification.com

FL Location

7565 Commerce Ct.
Sarasota, FL 34243
P: 941-487-2300
F: 941-487-2389

VA Location

4401 Wilson Boulevard, Suite 220
Arlington, VA 22203
P: 877-459-7726
F: 703-294-6560

Cooper Notification is Wheelock®  SAFEPATH® WAVES 

COOPER Notification

The BB-25 Cabinet is designed to house the CHS-6 Chassis. The cabinet is hinged at the bottom, and is shipped assembled. Below are the cabinet dimensions for installation.

BB-25 Cabinet

50898
Revision B

12/14/00
ECN 00-450

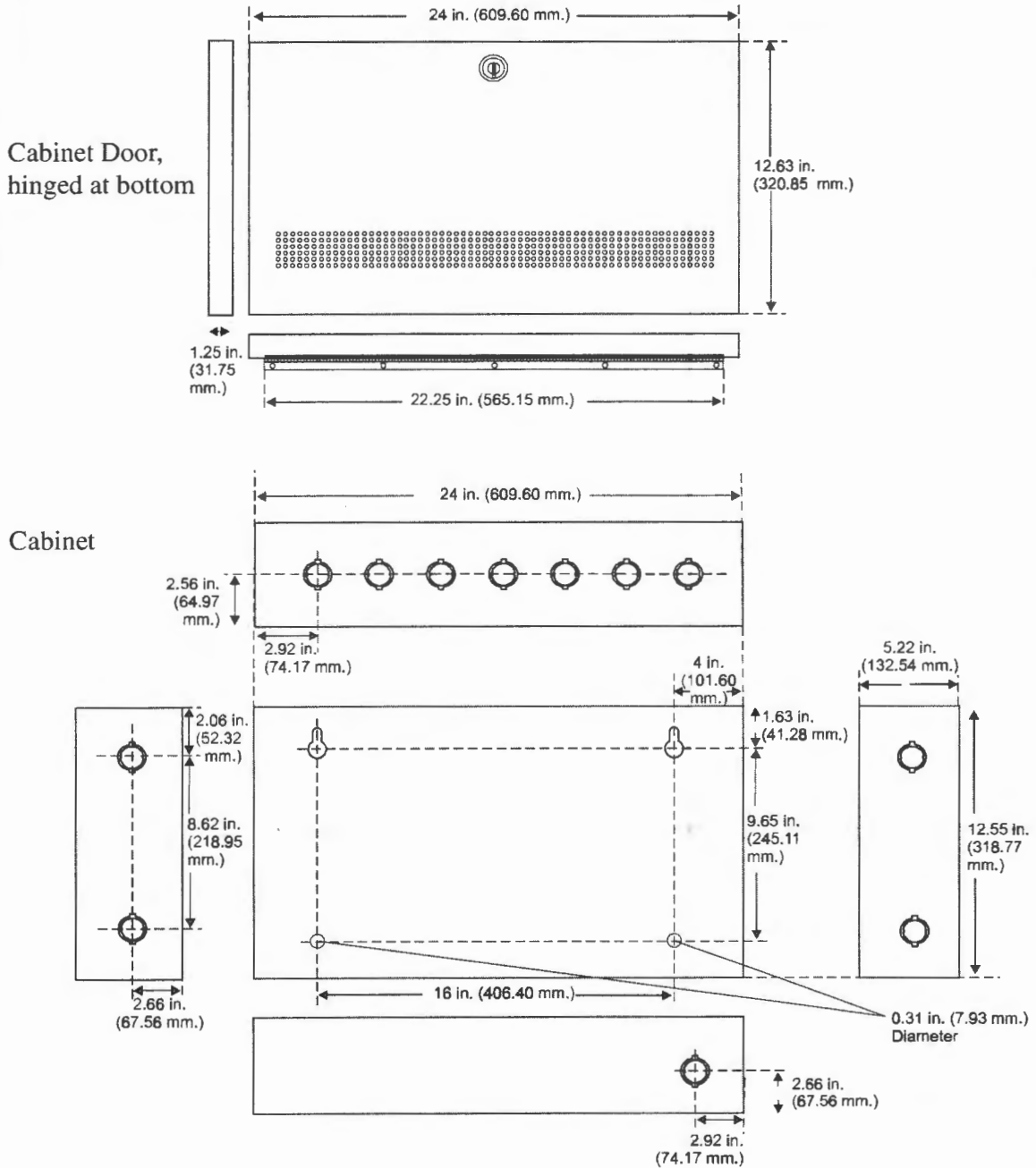

The BB-25 Cabinet comes with a false bottom plate. Place this plate in the bottom of the cabinet for battery support.

7750F

AES IntelliNet
CORPORATION For Alarm Monitoring

RF Subscriber Unit

UL Fire and AA Burglary Listed

NFPA-72 Compliant

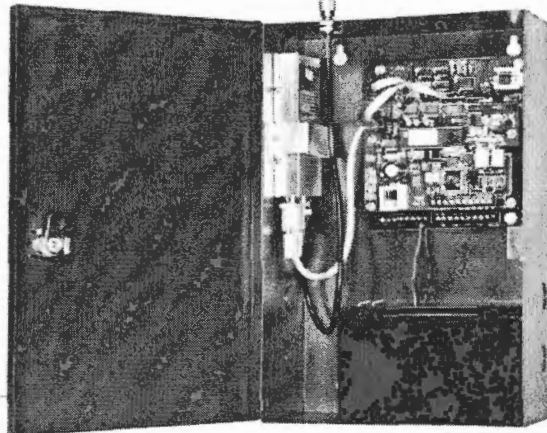

UL Listed

UL Listed Central station

Remote Station

864,827,1610,365,681

CSFM

Advanced Wireless Alarm Monitoring

The 7750-F smart subscriber unit links an alarm panel to an alarm monitoring central station. This 2-way transceiver and repeater in one is housed in a full size locking steel cabinet for superior performance. The 7750-F supports a wide range of inputs such as NO/NC/EOL and direct voltage. It automatically senses phone line cuts and antenna cuts, and monitors battery and AC power status. Advanced status reporting, self-diagnostics and a built-in power supply make the 7750-F the first choice for all wireless alarm communication needs.

Full Data for Fire and Burglary

Use with the optional FireTap for full fire data or the IntelliTap for full burglary data.

Available Configurations

7750 F 4x4 – 4 reversing polarity inputs plus 4 programmable EOL inputs

7750 F 8 – 8 programmable EOL inputs

Available Options

FireTap 7768

IntelliTap 7067

NEMA 4 Enclosure

High Gain Antenna

Back Up Battery

Available in Burglary Beige or Fire Red

- UL Listed (Fire & AA Burglary)
- NFPA-72 Compliant
- 864, 827,1610,365, 681
- Options for Full Data for Fire and Burglary
- Available in 4 & 8 Zone Configurations
- Built-in Power Supply and Battery Charger

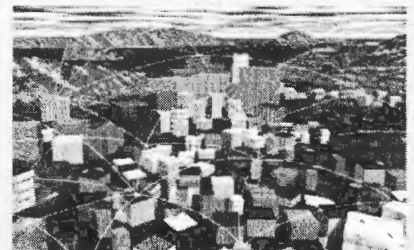

Wireless mesh networking is an innovative technology adopted by many industries with applications that need to communicate data over a large geographic area with a high level of reliability at a low total cost of ownership.

The advanced design and 2-way communications capability provides easy installation, expansion, and management when compared to alternative communication methods, both wired and wireless.

7750F RF Subscriber Unit

Technical Specifications

Radio

Standard CSAA frequency ranges: 450-470 MHz and 130-174 MHz, VHF and UHF. Others available

Standard Output Power

2 watts (requires FCC license)

Power Input

16.5 VAC, 40VA UL listed
Class II transformer required

Voltage

12 VDC nominal

Current

175mA standby; 800mA transmit

Alarm Signal Inputs

- 4 individually programmable
Zones: NO/NC/EOL, trouble
restore
- RS-232

Operating Temperature Range

0° to 50°C, 32° to 122°F

Storage Temperature Range

-10° to 60°C, 14° to 140°F

Relative Humidity Range

0-85% RHC non-condensing

Back up Battery

12V, 7 AH option

Low Battery Reporting

22.5-minute test cycle

AC Status

Reports to central station after approximately 4 minutes without AC power, reports power restored after approximately 4 minutes of restored power

Antenna Cut (local reporting)

12 VDC signal output at outputJ4,
200 mA max load

Open Collector Output

200mA maximum load

Size

13.25"H x 8.5"W x 4.3"D
34cm x 21.5cm x 11cm

Weight

6.4 lbs, 2.9 Kilograms
(excluding battery)

Colors

Available in standard
Burglary Beige or Fire Red
Please specify when ordering

Available Options

- 7750F-8 RF subscriber unit
with 8 EOL inputs
- 7750F-4x4 RF subscriber unit
with 4 EOL inputs and 4 reverse
polarity inputs
- 7768 - FireTap
- 7067 - IntelliTap

Please specify when ordering

Available configurations

- 4 EOL Inputs
- 8 EOL inputs
- 4 EOL inputs w/4 reverse
polarity inputs
- NEMA 4 Enclosure

AES-IntelliNet™ is the industry leader in delivering high quality wireless mesh networks to the fire and security industry in commercial, corporate, government, and educational applications with its broad line of products and advanced network management tools. Users of AES-IntelliNet networks have gained significant revenue, communications, and cost advantages while meeting the high standards of reliability required for the fire and security industry. AES-IntelliNet alarm monitoring systems are deployed at hundreds of thousands of locations in over 130 countries.



For more information

Call 800-AES-NETS (800-237-6387)

AES Corporation | 285 Newbury Street | Peabody, MA 01960 USA
Tel. +1 978-535-7310 | Fax +1 978-535-7313 | Email info@aes-intellinet.com
Web www.aes-intellinet.com

Copyright 2004 AES Corp.
AES-IntelliNet is a registered trademark of AES Corp.

7750F/12/04/R1



XF SERIES CLASS II TRANSFORMER

XF-1220



- UL Listed
- ROHS Compliant
- Direct plug-in to a 120VAC, 60 Hz power outlet
- Attractive designer white housing
- Output power 20VA Series
- Heavy polyurethane insulated copper windings
- Single voltage primary and secondary
- Dimensions (mm): 2.16W x 1.96D x 3.18H (55 x 50 x 81)

Model Number	Stock Number	Input Voltage (VAC)	Output Voltage (VAC)	Power Rating (VA)	Rated Secondary Current (A)	Max. Operating Temperature	Protection Device			Status Power Indicator
							Primary	Secondary	Type	
XF-1220	4550019	120	12	20	1.66	266°F	-	-	Inherently	-
XF-1620	4550025	120	16	20	1.21	266°F	-	-	Inherently	-
XF-2420	4550037	120	24	20	0.83	266°F	-	-	Inherently	-

Amseco transformers are specially designed for low voltage applications. The transformers are equipped with internal electrical overload protection and current fuses to meet UL requirements. Amseco products are built with quality components and provide high performance and long durability.

XF-2440



- UL Listed
- Direct plug-in to a 120VAC, 60 Hz power outlet
- Attractive designer white housing
- Output power 40VA and 50VA Series
- Heavy polyurethane insulated copper windings
- Single voltage primary and secondary
- Dimensions (mm): 2.67W x 2.36D x 3.18H (68 x 60 x 81)

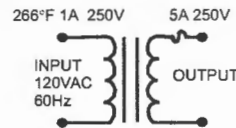

Model Number	Stock Number	Input Voltage (VAC)	Output Voltage (VAC)	Power Rating (VA)	Rated Secondary Current (A)	Max. Operating Temperature	Protection Device			Status Power Indicator
							Primary	Secondary	Type	
XF-1640	4550028	120	16	40	2.42	266°F	-	5A 125V	Current	-
XF-2440	4550039	120	24	40	1.66	266°F	-	3A 125V	Current	-
XF-1650	4550029	120	16	50	3.03	266°F	-	5A 125V	Current	-
XF-2450	4550040	120	24	50	2.08	266°F	-	3A 125V	Current	-

ADEMCO Hold Up Alarm Switch 269R 270R

- Completely silent operation
- DPDT switch with 45° screw terminal connectors
- Adhesive pads for temporary mounting during installation
- 270R same as 269R in plastic case



UL UIC Honeywell

GRI Vane Switch GI-4110A

- Vane switch shunt
- Latch type overhead door protection
- Armored cable or jacketed
- Mounting bracket included
- Lifetime warranty

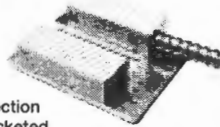

GRI Tamper Switches GI-TS01 GI-TSW01

- Screw terminals
- 12" leads
- Eliminates false alarms and service calls
- Fits most bell, siren, control panel mounting hole patterns
- Lifetime warranty



ADEMCO V-Plex Hold Up Alarm Switch 269SN

- Designed for ADEMCO 2-wire V-plex polling loop only
- Silent operation
- Adhesive pads for temporary mounting during installation
- Stainless steel cover
- 45° terminals for easy wiring



UL UIC Honeywell

GRI Resistor Pack GI-6644

- Features 2-1K 1/8 watt resistors
- 2 black leads and 2 blue leads
- Lifetime warranty



GRI Armored Disconnect Cable GI-823025

- For use with GRI pull apart switches
- Quick connect/disconnect
- 1 male and 1 female connector on 25' armored cable
- GI-831025 is white PVC coated to protect merchandise
- 1 year warranty

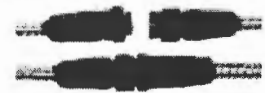

Potter Hold-Up Buttons PL-HUBM PL-HUBT

- 1 button, DPDT
- 2 button, 2 DPDT contacts
- Both models standard momentary or latching



UL UIC P POTTER The System of Protection

GE Security Magnapull™ Pull-Apart Cords SR-2105A

- High-impact plastic housing
- Protects free-standing items stored outside
- Installs easily & quickly



GE Security

ADEMCO Maximum Security Contact 968XTP

- Balanced magnetic contact
- 3' av moved cable
- Integrated tamper protection
- Surge protected to 2400VDC
- Indoor or outdoor use



UL Honeywell

ATW Electric Chime PR-PC100

- 78 - 85 dB, 6-18 VDC, 80 - 120 mA
- Pleasant sounding unit can be used as a doorbell or entry chime
- Compact & easy to conceal

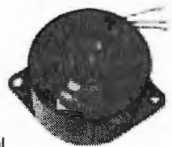

ATW Security

ADEMCO Motorized Bell AB12M

- 10" bell
- Low current draw
- Dual tamper switches



UL Honeywell

ADEMCO Extra Transient Protection 960

- Super 2.5" gap
- Surge protected to 2400VDC
- 3' stainless steel armored cable

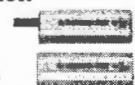

Overhead Door Contact 959

- W/2400VDC surge protect - 2" gap

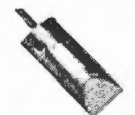

UL Honeywell

ADEMCO Wave Sounders WAVE2

- 106db 2-tone siren output
- Mounts horizontal or vertical
- Hinged cover for fast install



Also available: WAVE 8ohm/15W speaker

Honeywell

ADEMCO Low Current Piezo Siren WAVE2EX

- Selectable output: 100mA @ 106db 60mA @ 100db
- Mounts horizontal or vertical
- Hinged cover for fast install



Honeywell

ADEMCO Flush Mount Siren WAVE2F

- 106dB 2-tone siren output
- Fits standard double gang box
- Hinged cover for fast install

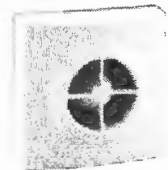

Also available: WAVE-F 18 ohm, 15W speaker

Honeywell



System Power Requirements

NFW2-100 Fire Alarm Control Panel

Protected Premises: <u>Nephrology Assoc.</u>	Date: <u>2/20/2012</u>
Address: <u>1600 Congress St.</u>	
City: <u>Portland</u> State: <u>Maine</u>	Zip: _____
Prepared By: <u>Norris Inc.</u>	Phone: <u>(207)-883-3473</u>
Address: <u>2257 West Broadway</u>	Email: _____
City: <u>South Portland</u> State: <u>Maine</u>	Zip: <u>04106</u>

AC Branch Current Requirements 3.00 AMPS @ 120 VAC

Current required by source to power the fire alarm system.

Primary Standby Load 0.36 Amps

Current load on the primary power supply during non-alarm conditions.

Primary Alarm Load 0.77 Amps

Current load on the primary power supply during alarm conditions.

Secondary Load Requirements 4.68 Amp Hours

Total Secondary Load from the calculation table below.

Current Draw		Time (hours)	Total (AH)
Secondary Standby Load 0.160 A	x	Required Standby Time	
		24 hours	3.84
Secondary Alarm Load 0.771 A	x	Required Alarm Time (hours)	
		0.084 hours	0.06
Total Secondary Load			3.90
Derating factor			x 1.2
Secondary Load Requirements			4.68

AH

Battery Selection 7 Amp Hours

Select batteries from the list below.

7 AH BAT-1270 Battery (12 volt)

- Two Four (two 12VDC sets in parallel)

Battery Distribution Chart

Shows amp-hour distribution of your selections.

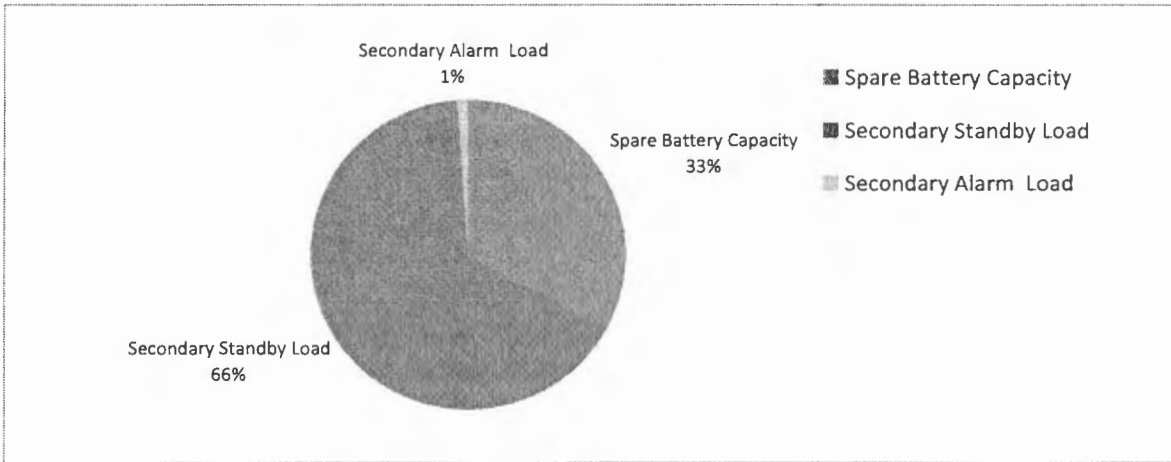

Comments

1. Batteries will fit in the FACP cabinet.
2. Selected battery size meets secondary load requirements.
3. The selected batteries (7AH) are within the charger range of this power supply (7-18AH).

Spare Battery Capacity	2.32	Battery Selection (AH) - Secondary Load Requirements (AH)
Secondary Standby Load	4.61	Secondary Standby Load (AH) * Derating Factor
Secondary Alarm Load	0.08	Secondary Alarm Load (AH) * Derating Factor



System Power Requirements

FCPS-24s8 Power Supply

Protected Premises: <u>Nephrology Assoc.</u>	Date: <u>2/20/2012</u>
Address: <u>1600 Congress St.</u>	
City: <u>Portland</u> State: <u>Maine</u>	Zip: _____
Prepared By: <u>Norris Inc.</u>	Phone: <u>(207)-883-3473</u>
Address: <u>2257 West Broadway</u>	Email: _____
City: <u>South Portland</u> State: <u>Maine</u>	Zip: <u>04106</u>

AC Branch Current Requirements 3.20 AMPS @ 120 VAC

Current required by source to power the fire alarm system.

Primary Standby Load 0.09 Amps

Current load on the primary power supply during non-alarm conditions.

Primary Alarm Load 3.36 Amps

Current load on the primary power supply during alarm conditions.

Secondary Load Requirements 2.21 Amp Hours

Total Secondary Load from the calculation table below.

Current Draw		Time (hours)	Total (AH)
Secondary Standby Load 0.065 A	x	Required Standby Time	
		24 hours	1.56
Secondary Alarm Load 3.355 A	x	Required Alarm Time (hours)	
		0.084 hours	0.28
Total Secondary Load			1.84
Derating factor			x 1.2
Secondary Load Requirements			2.21

AH

Battery Selection 7 Amp Hours

Select batteries from the list below.

7 AH BAT-1270 Battery (12 volt)

- Two Four (two 12VDC sets in parallel)

Battery Distribution Chart

Shows amp-hour distribution of your selections.

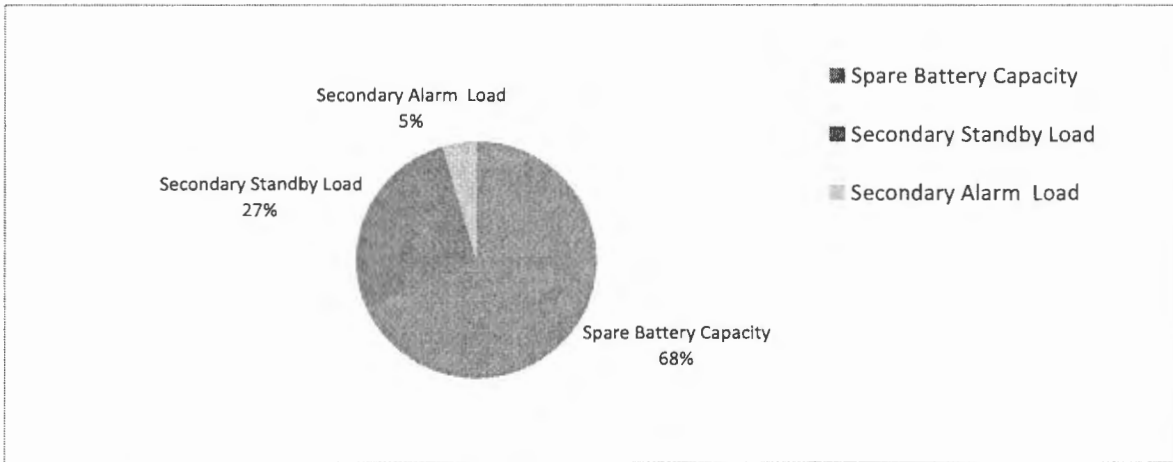

Comments

1. Batteries will fit in the FACP cabinet.
2. Selected battery size meets secondary load requirements.
3. The selected batteries (7AH) are within the charger range of this power supply (7-18AH).

Spare Battery Capacity	4.79	Battery Selection (AH) - Secondary Load Requirements (AH)
Secondary Standby Load	1.87	Secondary Standby Load (AH) * Derating Factor
Secondary Alarm Load	0.34	Secondary Alarm Load (AH) * Derating Factor

Important! Securing Screws MUST be installed in top of Device on Escanor series HSR and STR Audio visuals.

Important! Wiring connections must have correct polarity.

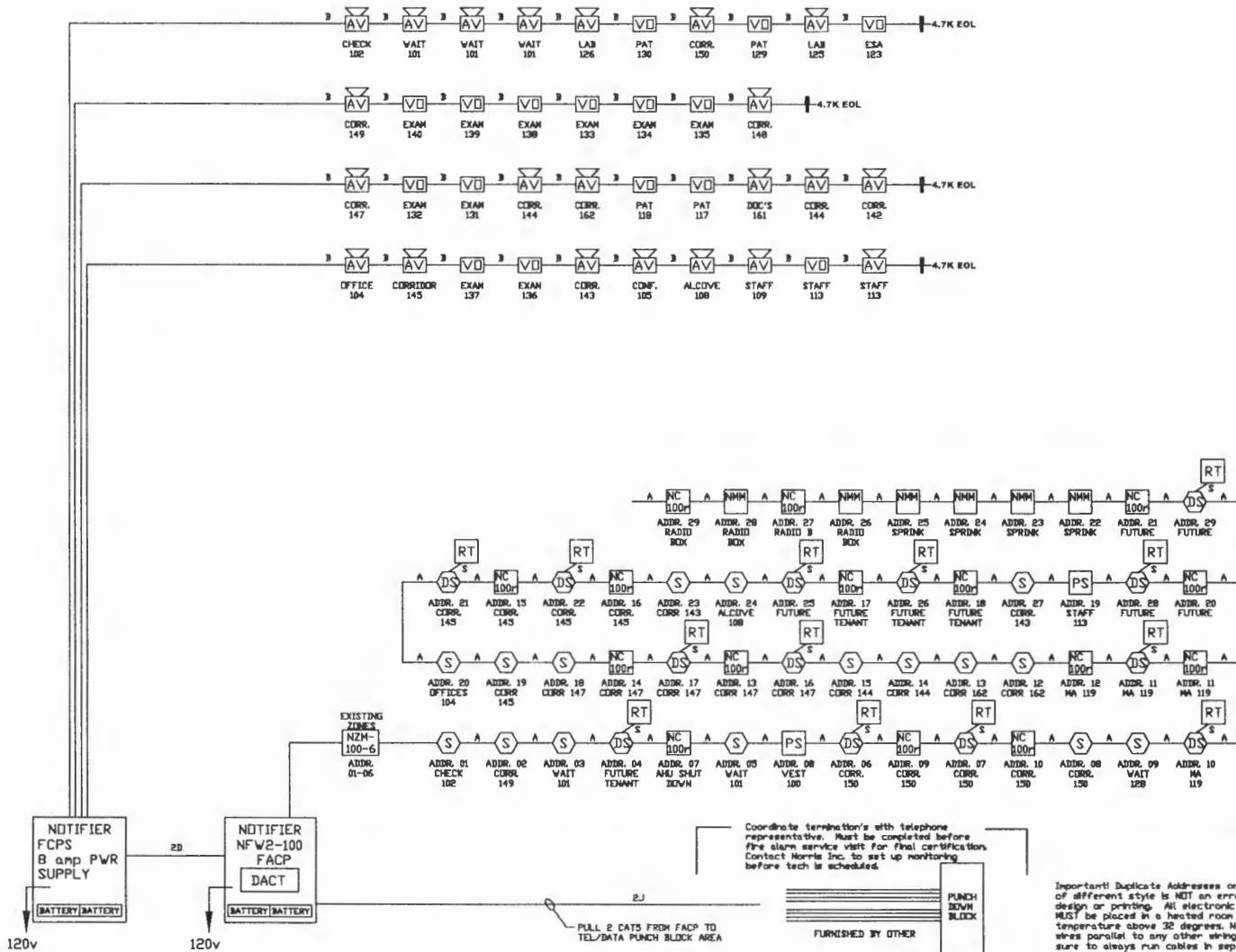

LEGEND

- 48 INCHES PS PULL STATION
- S SMOKE DETECTOR
- R HEAT DETECTOR RATE OF RISE
- F HEAT DETECTOR FIXED TEMP
- RT REMOTE TEST/INDICATOR
- DS DUCT SMOKE DETECTOR
- 80 INCHES VO VISUAL ONLY
- AV AUDIO / VISUAL
- NFM ZONE MODULE
- NC CONTROL MODULE
- NHM MONITOR MODULE 100-4 SQUARE, 100-4-100-4
- NC RELAY MODULE
- STS SPRINKLER TAMPER
- SPS SPRINKLER PRESSURE
- SFS SPRINKLER FLOW

This drawing is a typical device layout, wiring is shown diagrammatically only. This drawing has been provided as an example ONLY. Riser does not necessarily indicate all devices and appliances. See floor plans and specification for location and quantities. The purchaser must accurately layout the initiating and notification devices in their proper zones/circuit. Note: All signal circuits have a 25 amp load limitation and a combined load limitation of 3.0 amps or 6.0 amps if XRM-24 is added to the panel. There can be 4 class B noc circuits or 2 class A noc circuits. REMOTE power supply has a 3.0 amps limitation per circuit and an 8.0 amp combined limitation for all 4 circuits. (see chart below for current vs. candle rating)

Room Size	Candle Rating	Load (amps)
20' x 20'	15 cd	0.06 amps
28' x 28'	30 cd	0.10 amps
45' x 45'	75 cd	0.15 amps
54' x 54'	110 cd	0.20 amps

- A 1 PR #12 AWG TWISTED-PAIR UNSHIELDED CABLE FPL GENESIS 4515, BELDEN 6020UL (Up to 10,000 Ft)
- A 1 PR #14 AWG TWISTED-PAIR UNSHIELDED CABLE FPL GENESIS 4513, BELDEN 6100UL (Up to 8,000 Ft)
- A 1 PR #16 AWG TWISTED-PAIR UNSHIELDED CABLE FPL GENESIS 4511, BELDEN 6220UL (Up to 4,500 Ft)
- B 1 PR #12 AWG FPL CABLE
- D 1 PR #14 AWG FPL CABLE
- E 1 PR #16 AWG FPL CABLE
- F 2c #12 AWG CABLE
- G 2c #14 AWG CABLE
- H 1 PR #16 AWG TWISTED-PAIR SHIELDED CABLE FPL
- J 1 CAT5 CABLE

REVISION 2	DATE:
REVISION 1	DATE:
REVISION 0 SUBMITTAL	DATE: 2/14/2012

PROJECT NAME
Nephrology Associates
Portland, MAINE

SCALE NTS
BY: **EAJ**
CK BY:

SAVED AS:

NORRIS INC
Provided For Temporary Reference Only
2257 BROADWAY, S.D. PORTLAND, MAINE

Coordinate termination's with telephone representative. Must be completed before fire alarm service visit for final certification. Contact Norris Inc. to set up monitoring before tech is scheduled.

Important! Duplicate Addresses on devices of different style is NOT an error in design or printing. All electronic devices MUST be placed in a heated room with temperature above 32 degrees. Never run wires parallel to any other wiring. Make sure to always run cables in separate raceways. Fire alarm wiring can emit noise that may affect other devices. Shielded cable can be used if cable is run near sensitive equipment.

PULL 2 CAT5 FROM FACP TO TEL/DATA PUNCH BLOCK AREA

FURNISHED BY OTHER



SYMBOL LEGEND

This drawing is a typical set up for a AES box. Please verify with the Fire Dept for # of Zones required.

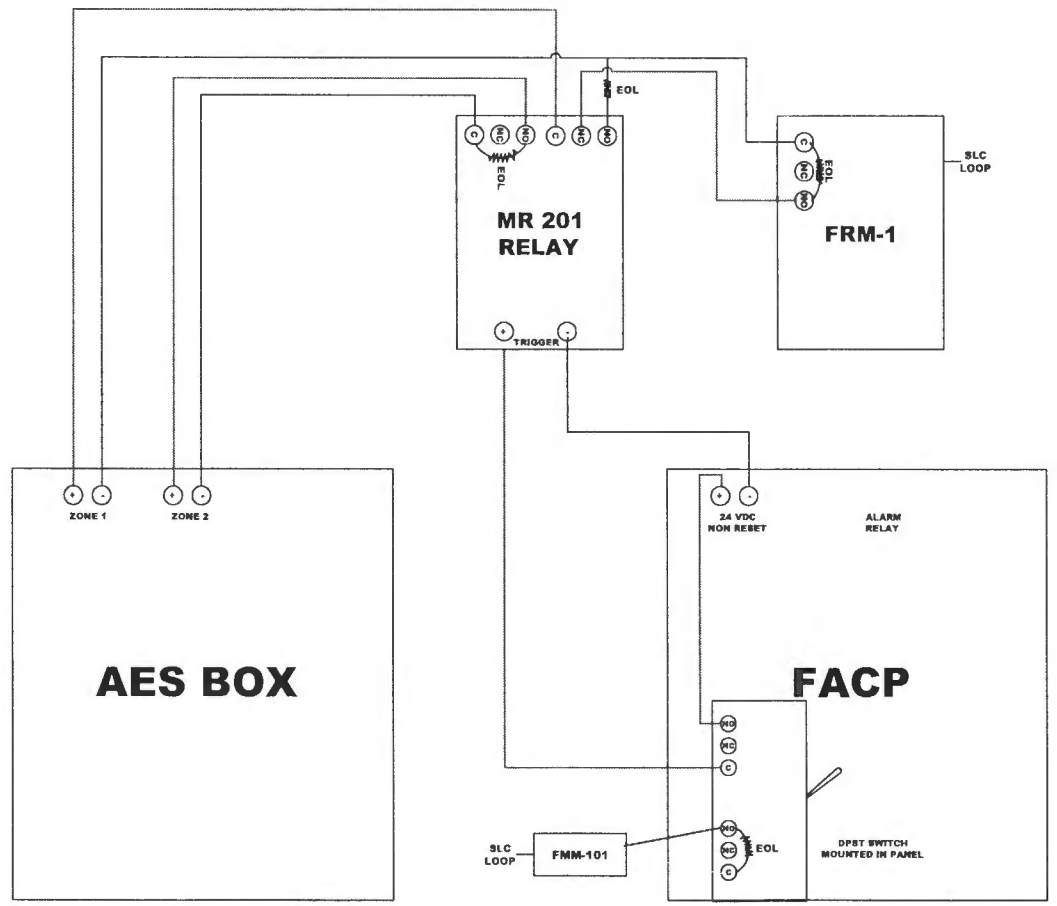

REVISION 2	DATE:
REVISION 1	DATE:
REVISION 0 SUBMITTAL	DATE: 2-20-2012
SYSTEM WIRING RISER	
PROJECT NAME	SCALE NTS
Nephrology Assoc. Portland, MAINE	BY: EAD CK BY:
 <small>Prepared For: Insurance; Delivered Today</small> 2257 BROADWAY, SOUTH PORTLAND, MAINE	
SAVED AS:	

SYSTEM INPUTS		CONTROL UNIT ACTIVATION								NOTIFICATION				REQUIRED FIRE SAFETY CONTROL							
		A	B	C	D	E	F	G	H	I	J	K	L	M	N	O	P	Q	U	V	
1	MANUAL FIRE ALARM PULL STATION	●	●					●	●	●		●					●				1
2	AREA SMOKE DETECTOR	●	●					●	●	●		●					●				2
3	AREA HEAT DETECTOR	●	●					●	●	●		●					●				3
4	IN-DUCT SMOKE DETECTOR			●	●			●	●	●		●							●		4
5	SPRINKLER WATERFLOW	●	●					●	●	●		●					●				5
6	SPRINKLER CONTROL VALVE			●	●			●	●	●		●									6
7	FIRE ALARM AC POWER FAILURE					●	●	●	●	●		●									7
8	FIRE ALARM SYSTEM LOW BATTERY					●	●	●	●	●		●									8
9	OPEN CIRCUIT					●	●	●	●	●		●									9
10	GROUND FAULT					●	●	●	●	●		●									10
11	NOTIFICATION APPLIANCE CIRCUIT SHORT					●	●	●	●	●		●									11
12																					12
13																					13
14																					14
15																					15
16																					16
17																					17
18																					18
19																					19
20																					20
21																					21

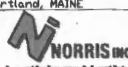
REVISION 2	DATE:
REVISION 1	DATE:
REVISION 0 SUBMITTAL	DATE: 3/13/2012
SYSTEM WIRING RISER	
PROJECT NAME Nephrology Associates Portland, MAINE	SCALE NTS BY: ZAD CK BY:
 NORRIS INC Prepared For: Tommaso, Deborah Taylor 2257 BROADWAY, S.D. PORTLAND, MAINE	SAVED AS:



CITY OF PORTLAND, MAINE

Department of Building Inspections

Original Receipt

2/21 2012

Received from Melissa Peters

Location of Work 1600 Congress / 530 Riverside

Cost of Construction \$ 1600 Congress Building Fee: 200.00

Permit Fee \$ 530 Riverside Site Fee: 120.00

10,000
Certificate of Occupancy Fee: _____

Fire Alarm Total: 320.00

Building (IL) _____ Plumbing (I5) _____ Electrical (I2) _____ Site Plan (U2) _____

Other _____

CBL: _____

Check #: _____ Total Collected \$ 320

**No work is to be started until permit issued.
Please keep original receipt for your records.**

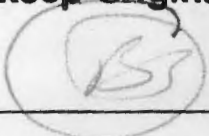
Taken by: 

WHITE - Applicant's Copy
YELLOW - Office Copy
PINK - Permit Copy