

12 UPPER CABINET W/ UNDER LIGHT TO CEILING
SCALE: 1 1/2" = 1'-0"

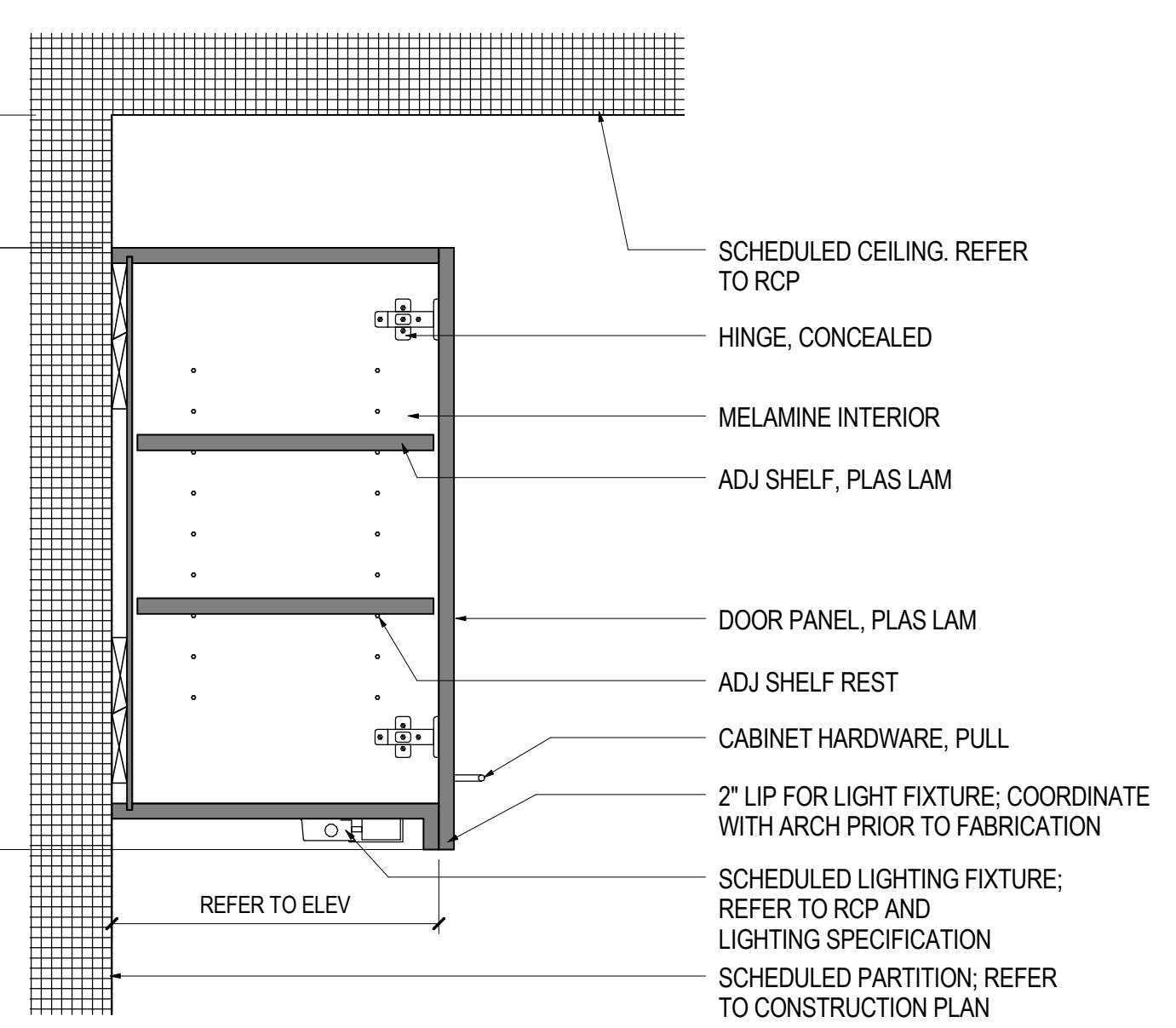

08 DETAIL UPPER CABINET TOP FREE
SCALE: 1 1/2" = 1'-0"

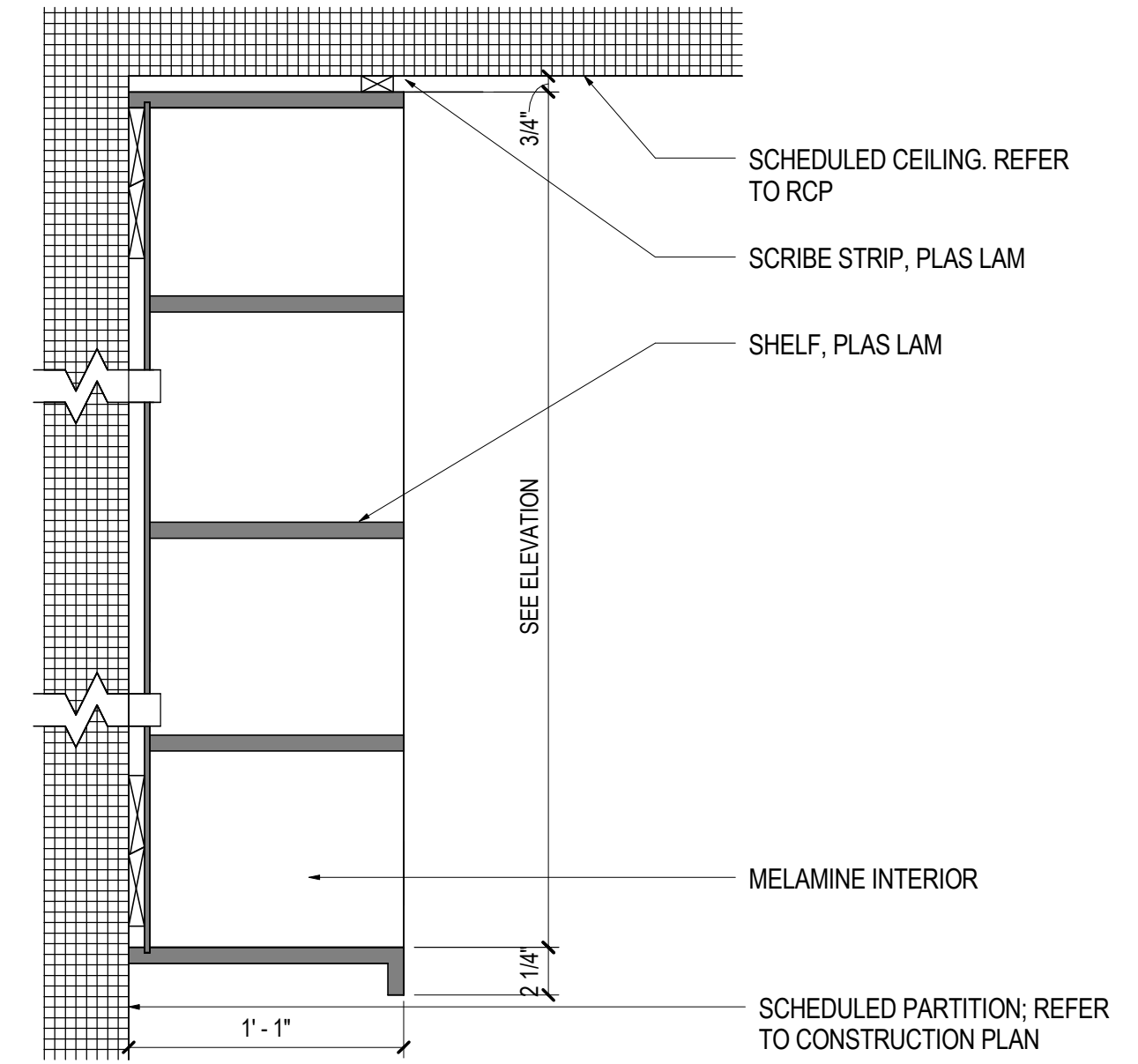

05 DETAIL OPEN SHELVES
SCALE: 1 1/2" = 1'-0"

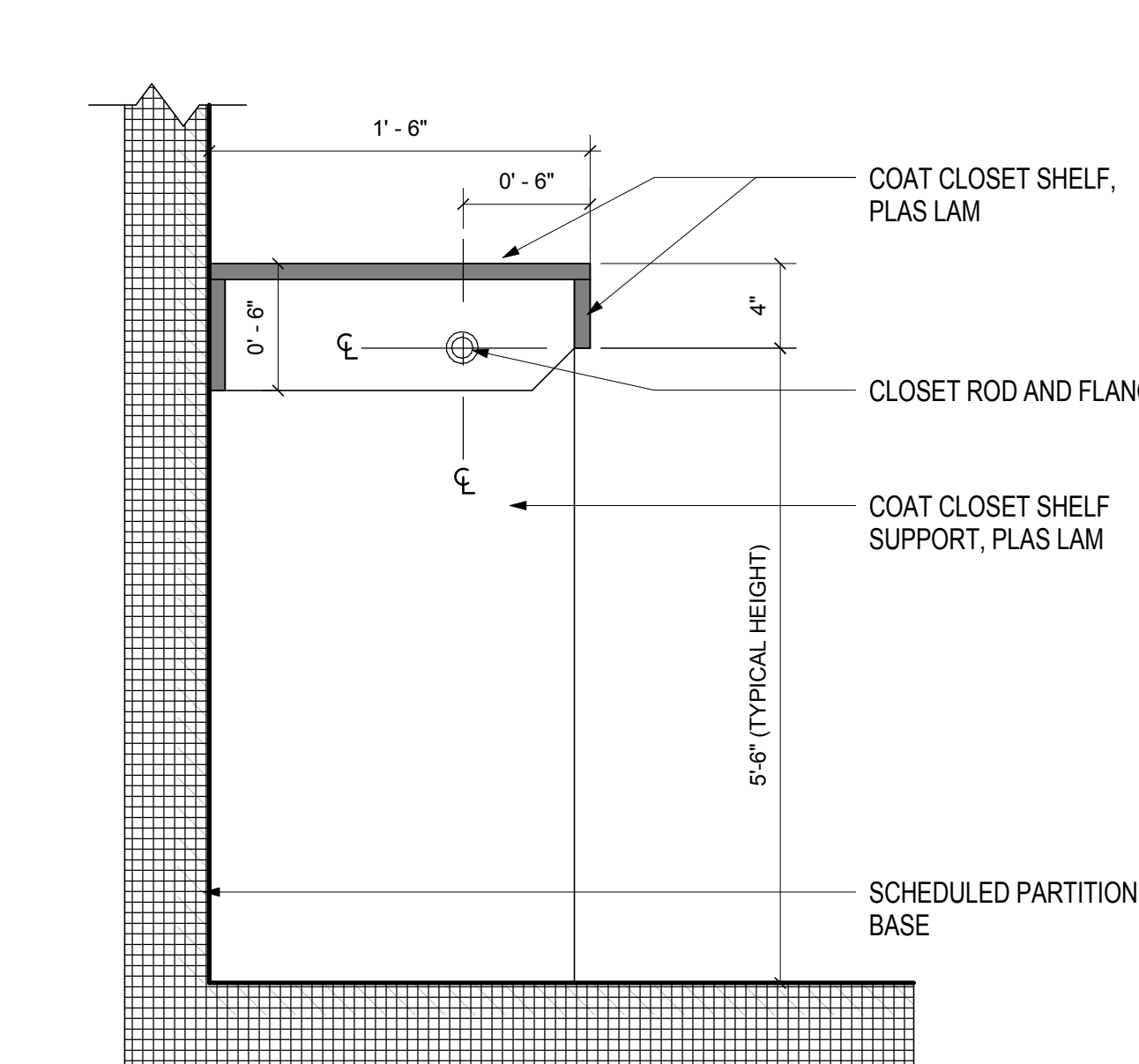

03 CLOSET SHELF AND ROD
SCALE: 1 1/2" = 1'-0"

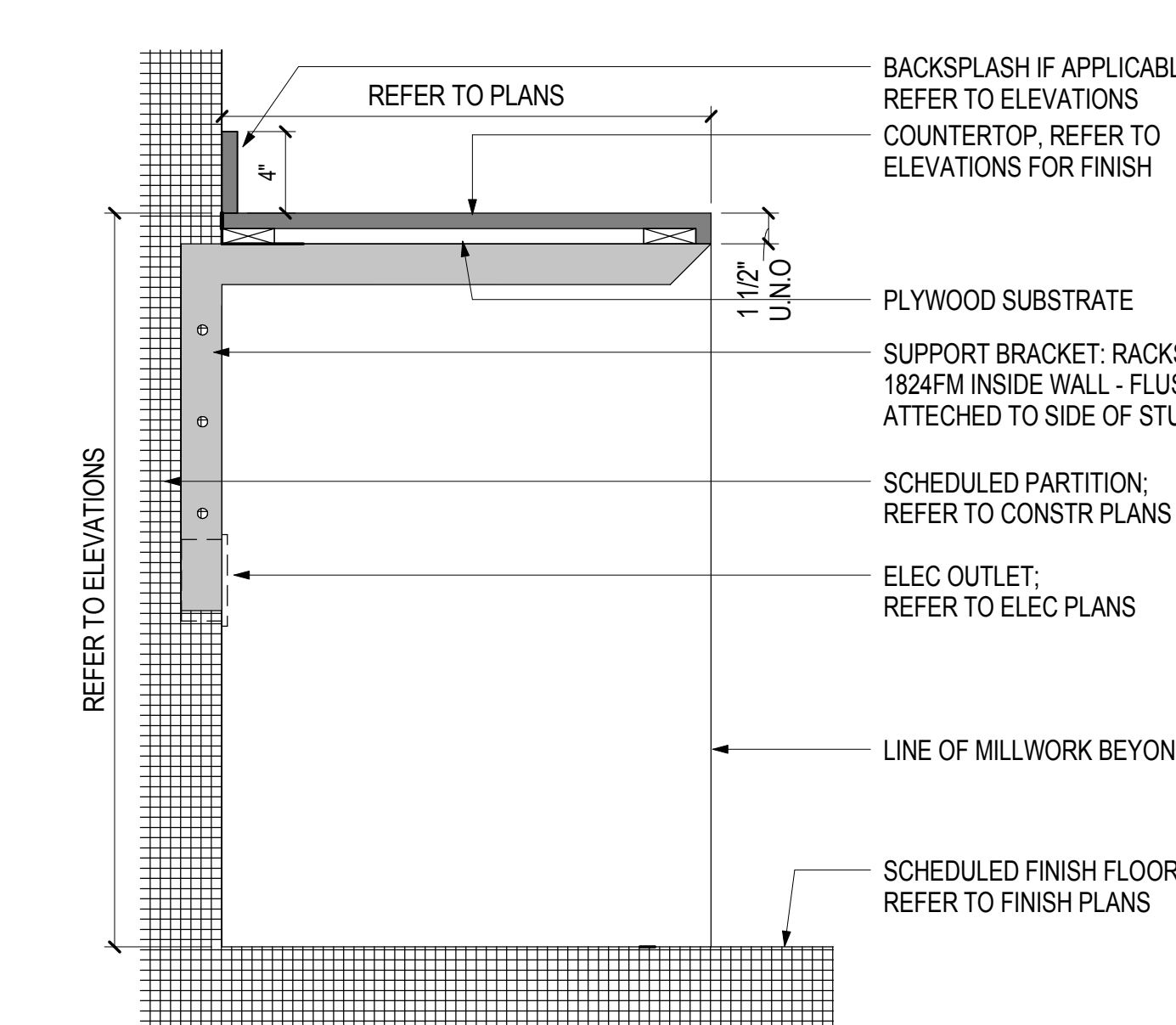

01 BASE COUNTER - OPEN
SCALE: 1 1/2" = 1'-0"

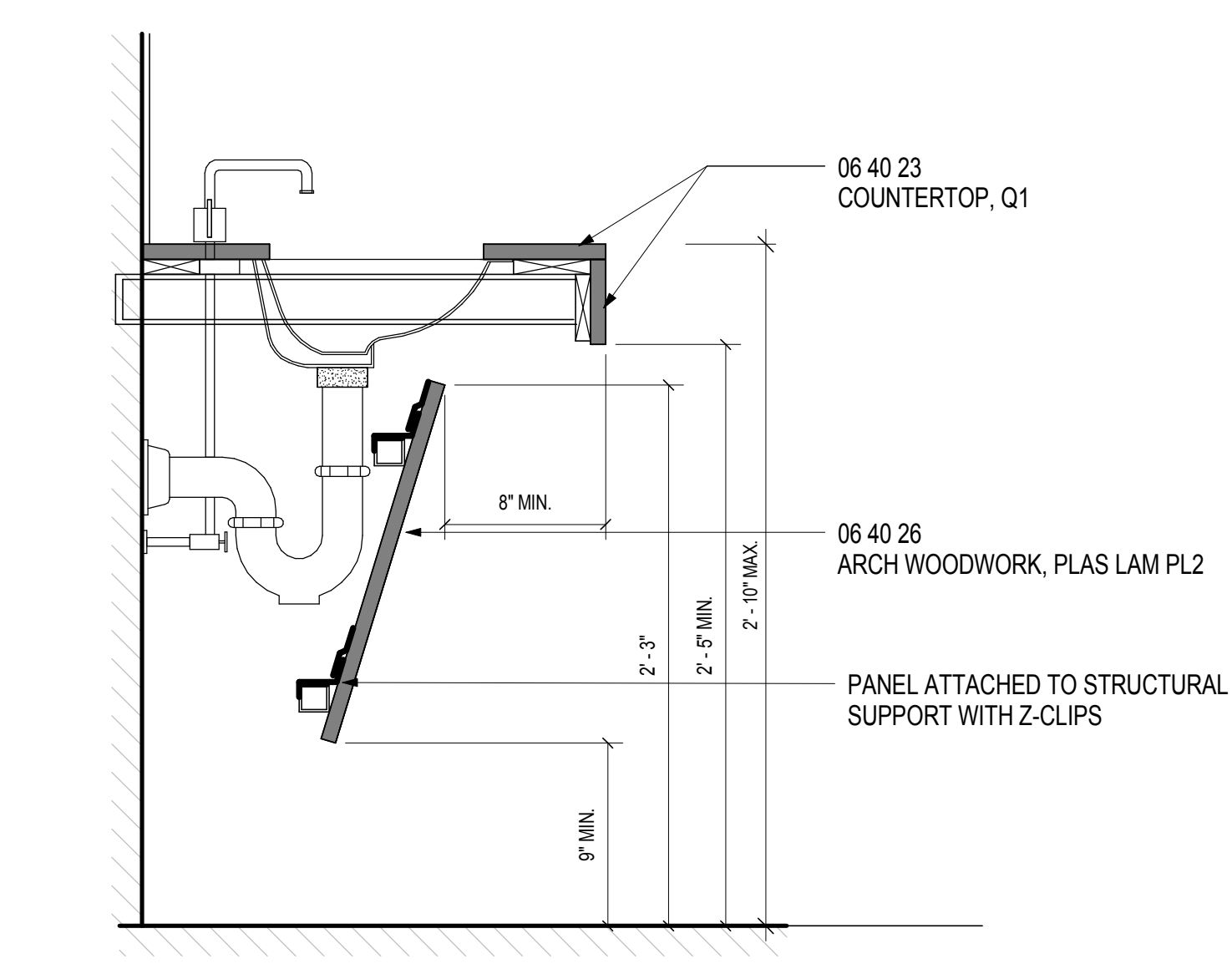

13 LAVATORY COUNTER
SCALE: 1 1/2" = 1'-0"

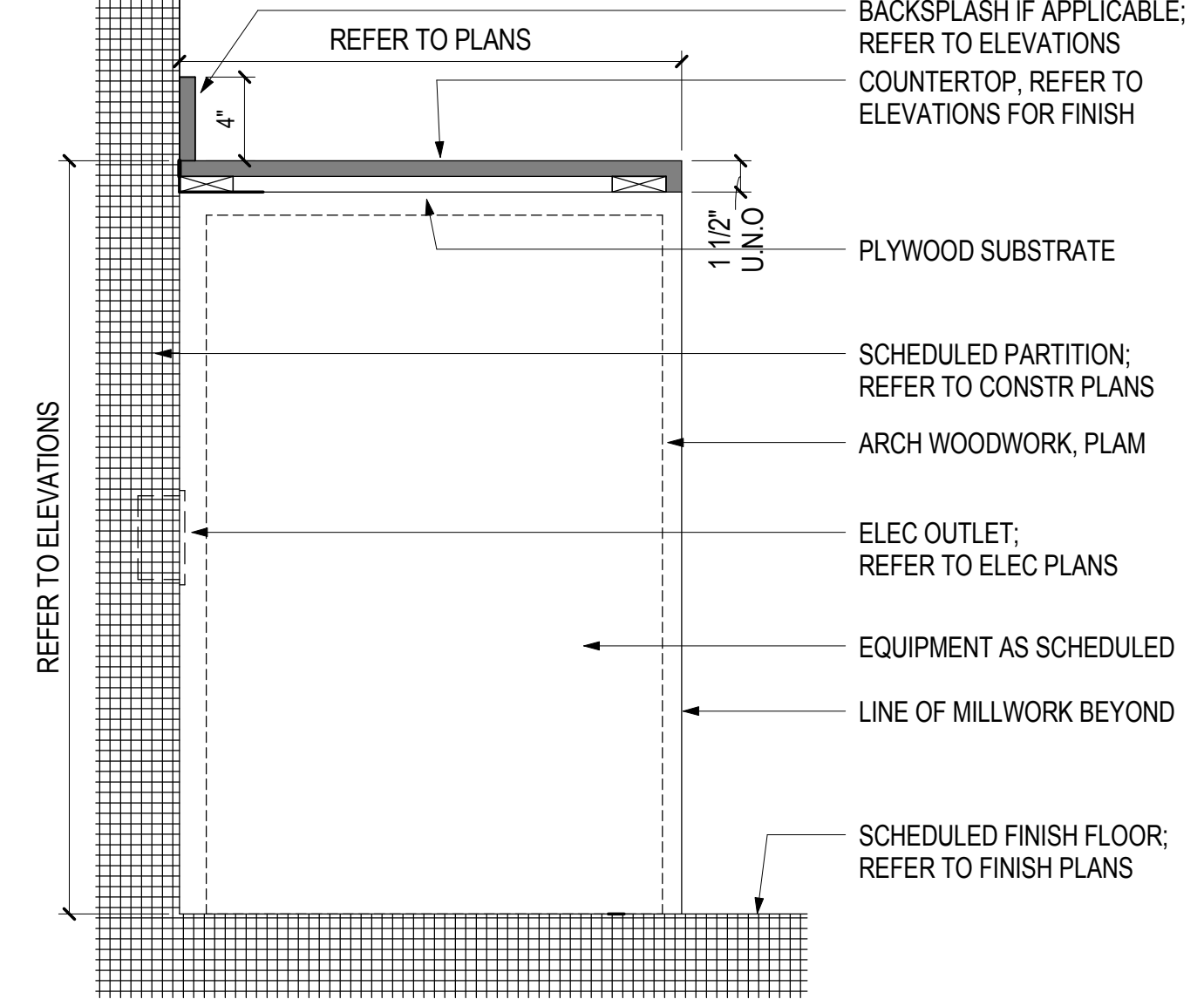

09 BASE CABINET - EQUIPMENT
SCALE: 1 1/2" = 1'-0"

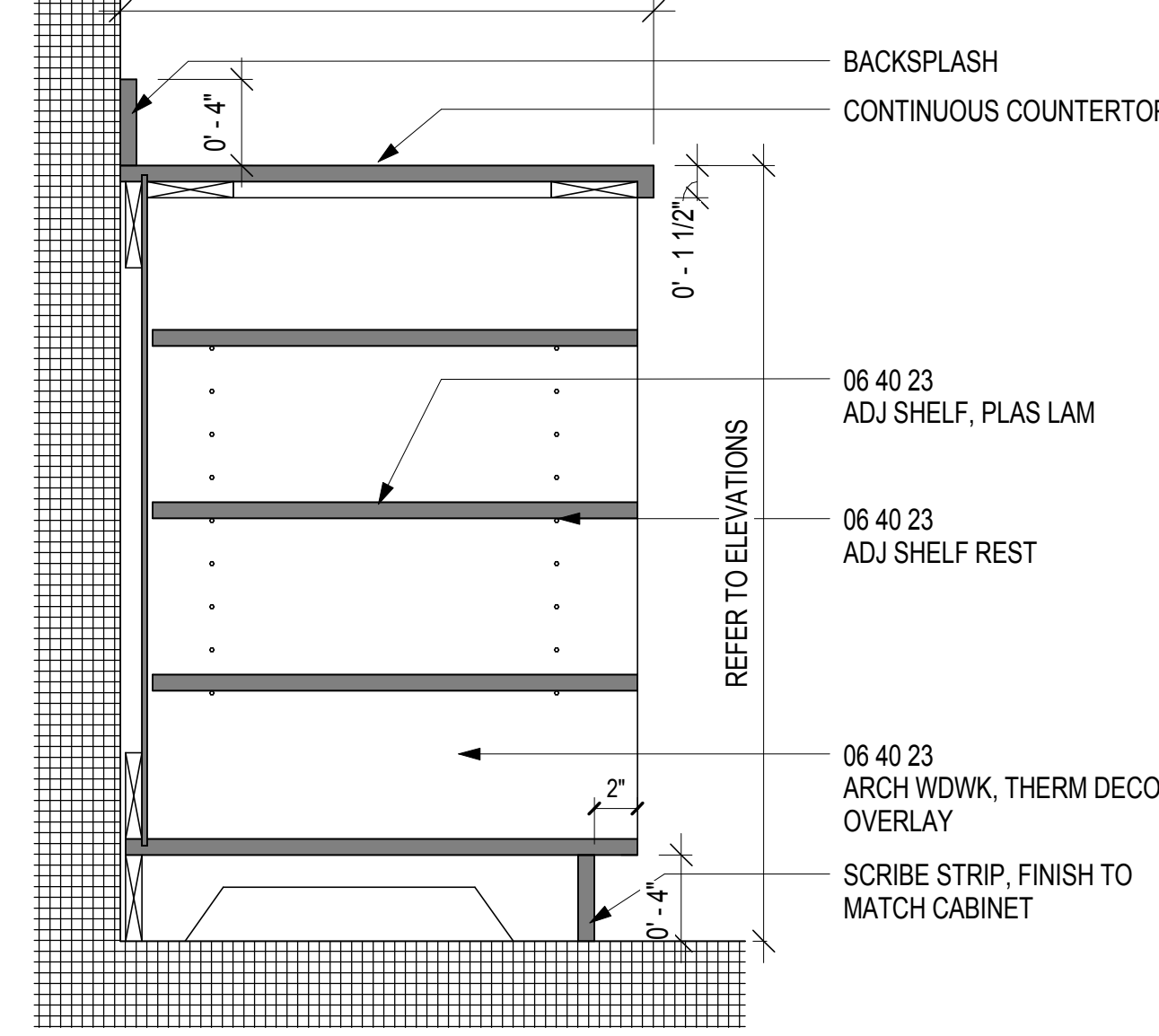

06 BASE CABINET OPEN SHELVING
SCALE: 1 1/2" = 1'-0"

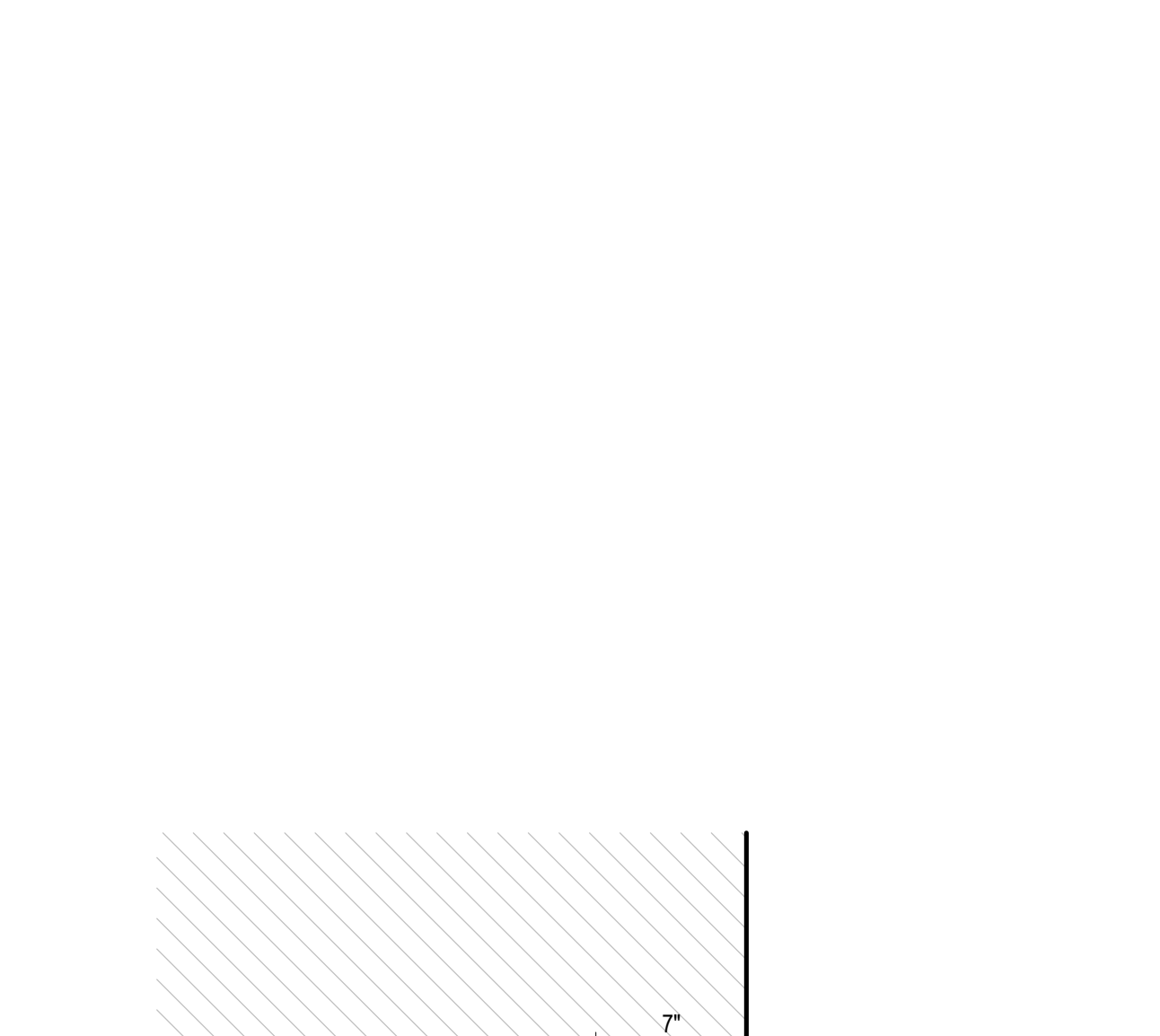

04 PLINTH FOR FURNITURE LOCKERS
SCALE: 1 1/2" = 1'-0"



02 MAIL SLOTS
SCALE: 1 1/2" = 1'-0"

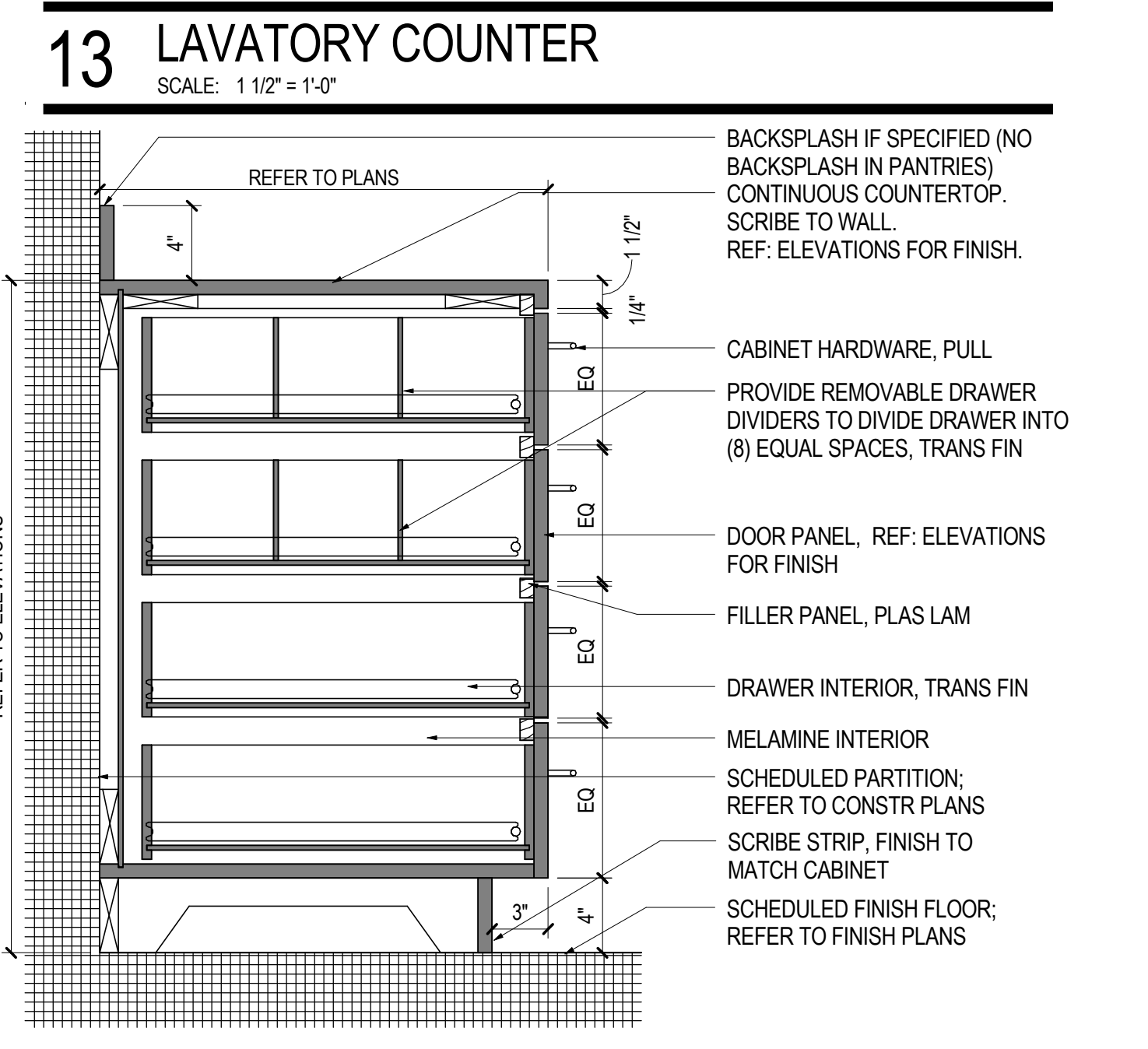

14 DETAIL BASE CABINET WITH DRAWERS (4)
SCALE: 1 1/2" = 1'-0"

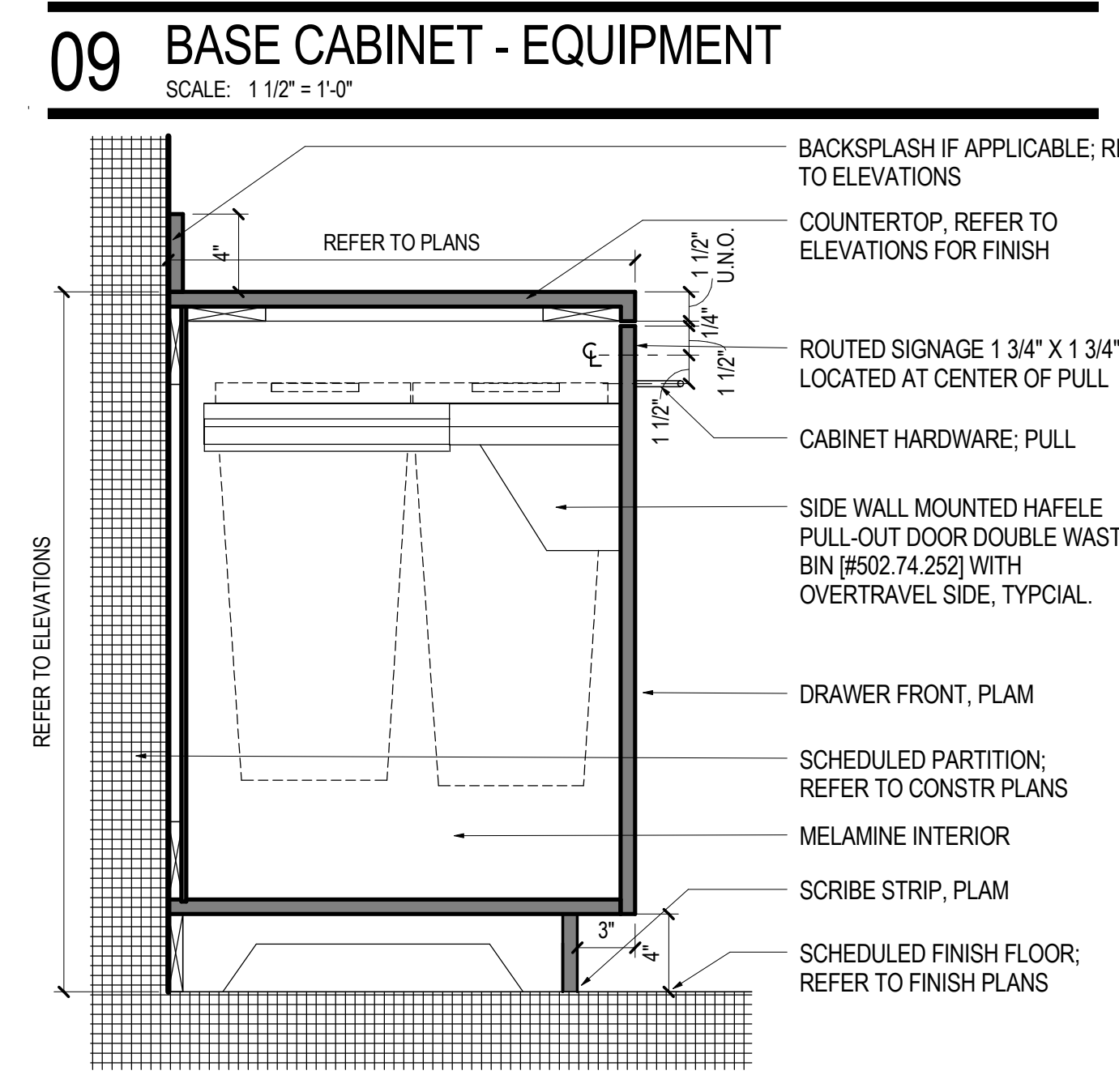

10 BASE CABINET - PULL-OUT TRASH CABINET
SCALE: 1 1/2" = 1'-0"

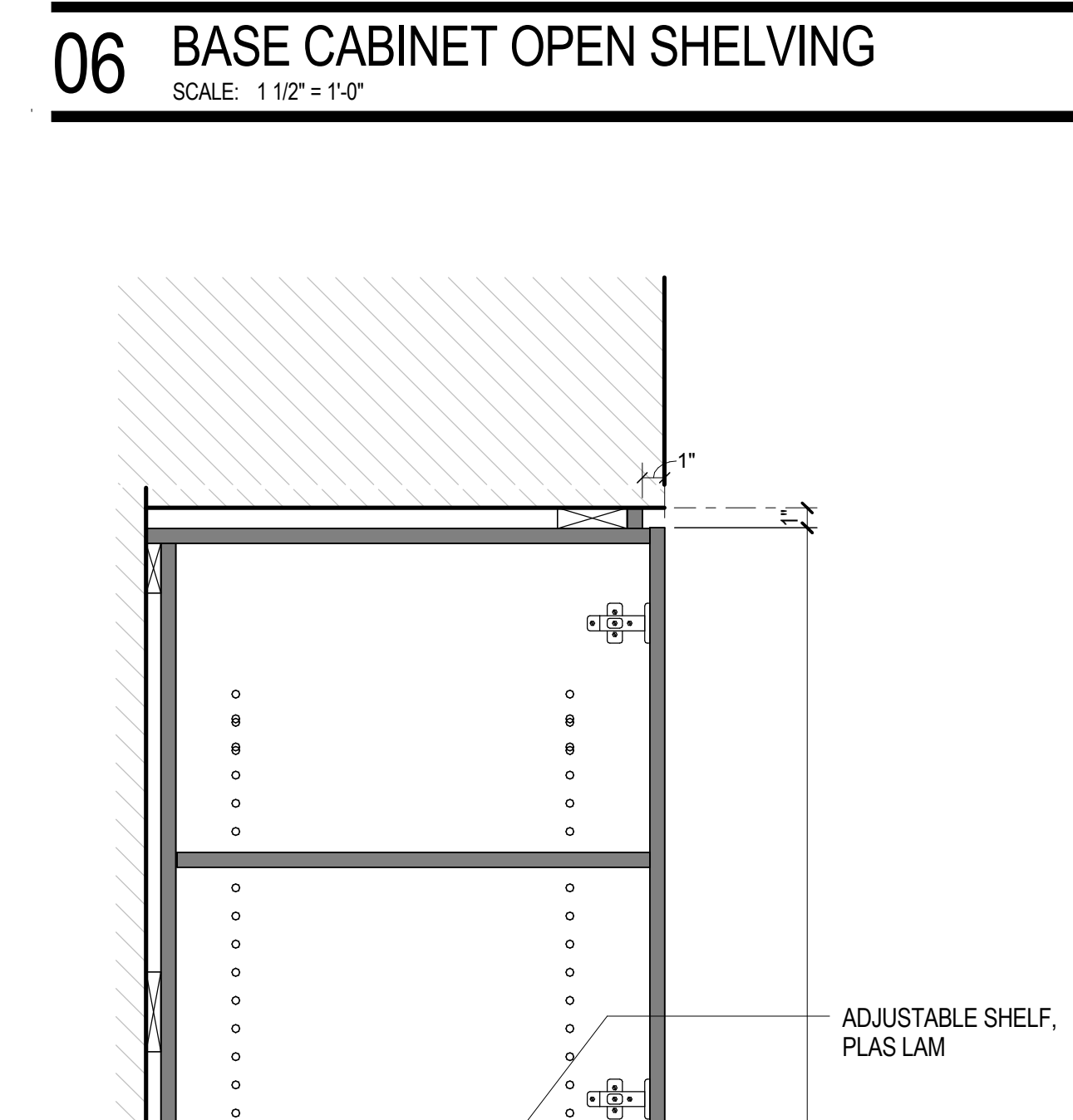

07 FULL HEIGHT CABINET
SCALE: 1 1/2" = 1'-0"

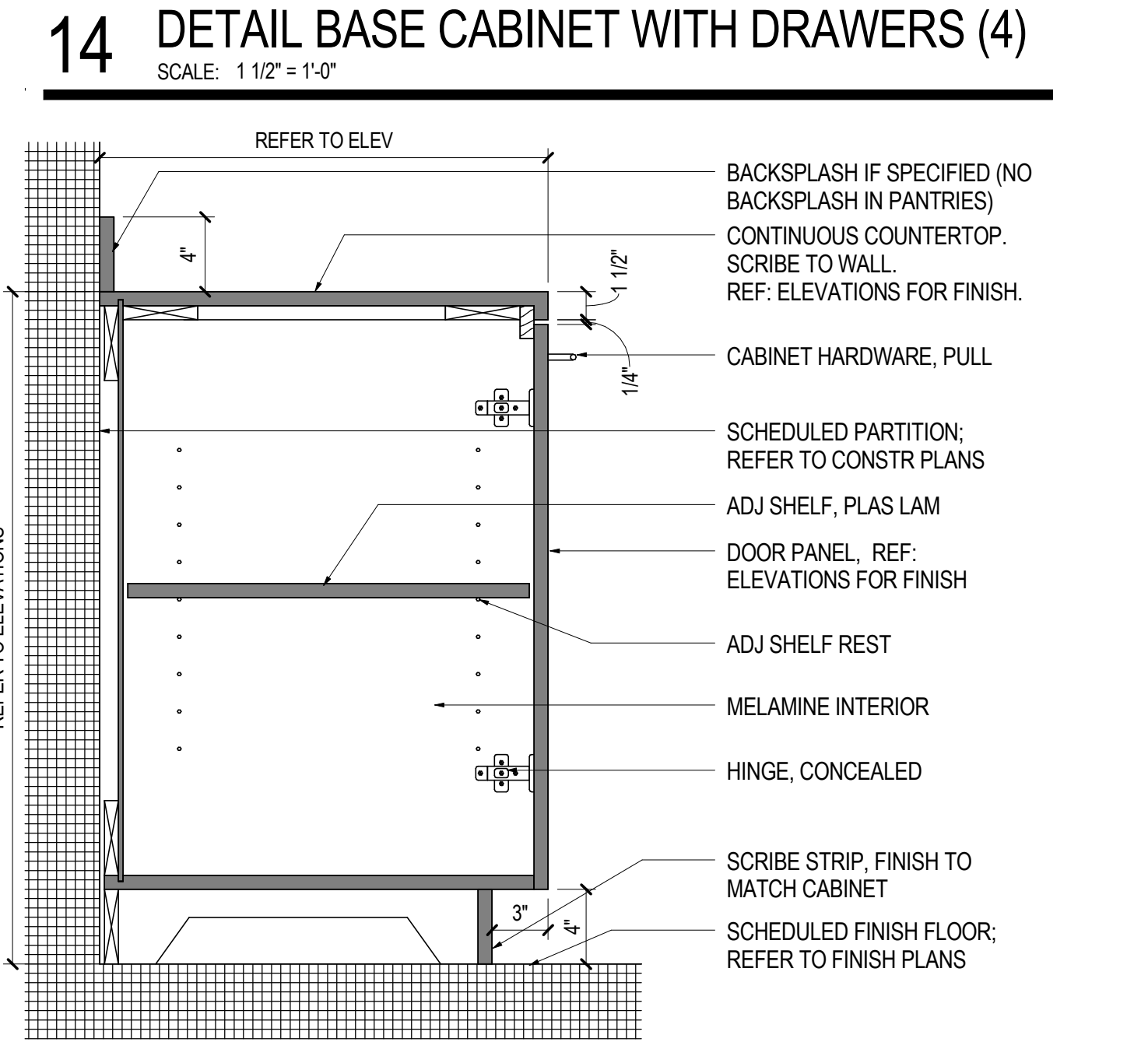

15 BASE CABINET WITH DOOR
SCALE: 1 1/2" = 1'-0"

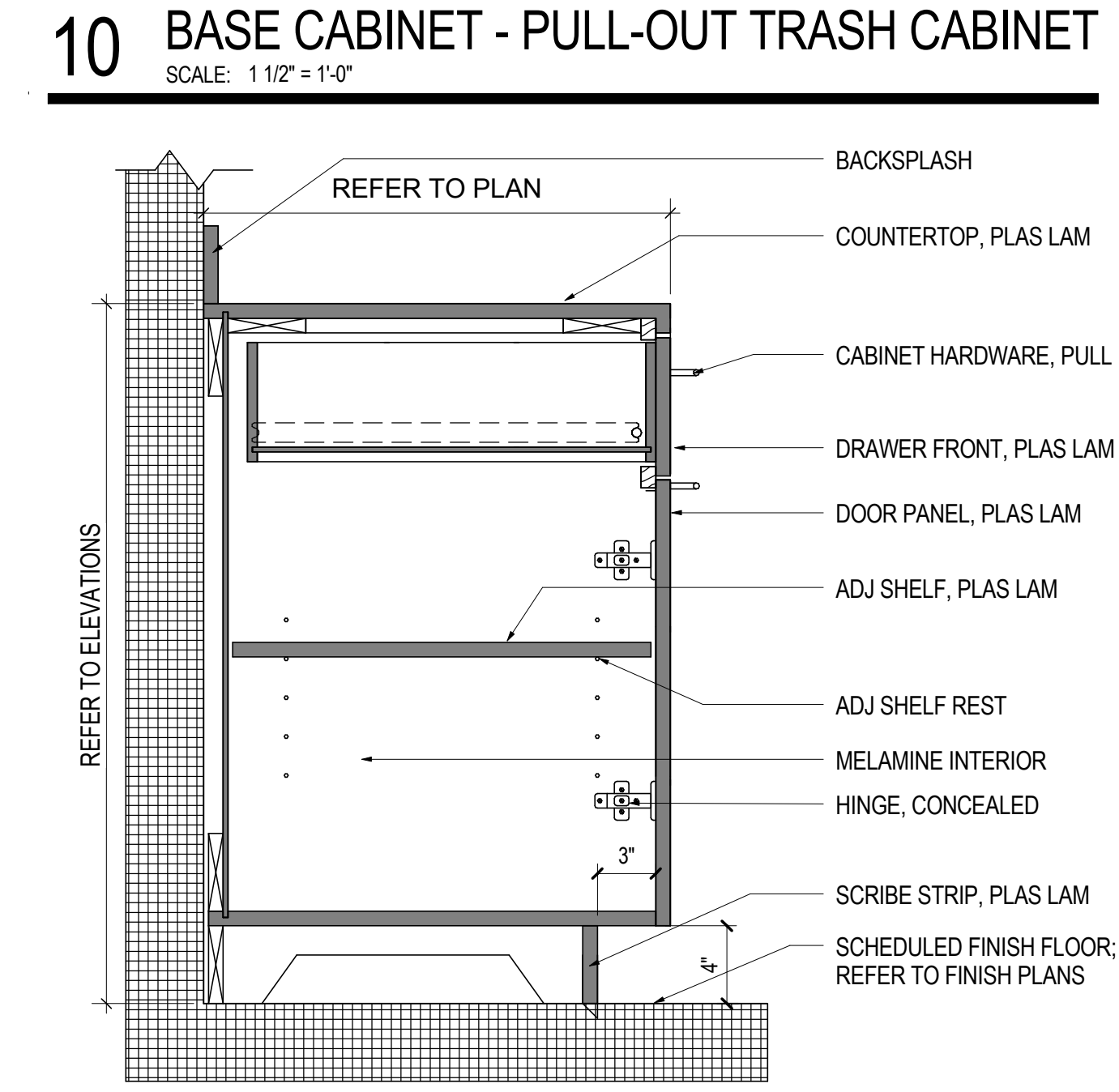

11 BASE CABINET WITH SINGLE DRAWER
SCALE: 1 1/2" = 1'-0"

Date	Description
08/18/17	ISSUE FOR PERMIT & CONSTRUCTION

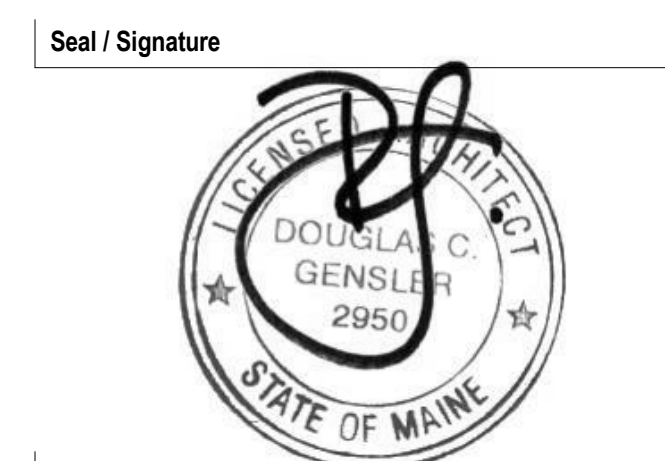

Project Name
Unum Workplace Transformation - Phase 1 (H02)

Project Number
59.6481.003

Description
DETAILS - MILLWORK

Scale
1 1/2" = 1'-0"

A08.500

8/10/2017 6:58:40 PM I:\gensler_ad\projects\Revit\A08.500\A08.500_1003 - UNUM - PORTLAND - H02_2016_MichaelThomasGensler.rvt