

GRANT HAYS ASSOCIATES
 ARCHITECTURE & INTERIOR DESIGN
 P.O. BOX 6179 FALMOUTH MAINE 04105
 207.871.5900 www.granthays.com

SCALE
 LICENSED ARCHITECT
 MICHAEL F. HAYS
 No. 1724
 STATE OF MAINE
 Michael F. Hays
 REV/10/17

DRAWING NAME
 NEA
 NORTH EAST AIR
 PORTLAND INTERNATIONAL AIRPORT
 PORTLAND, MAINE 04102
 1011 WILTBROOK STREET

PHASE I
 DETAILS

DATE: 14 DEC '15
 SCALE: AS NOTED
 DRAWN: MFH/mgk
 JOB NO.: 150655
 SHEET: A16
 COPYRIGHT REPRODUCTION OR REVUE OF THIS DOCUMENT WITHOUT WRITTEN PERMISSION FROM GRANT HAYS ASSOCIATES IS PROHIBITED.

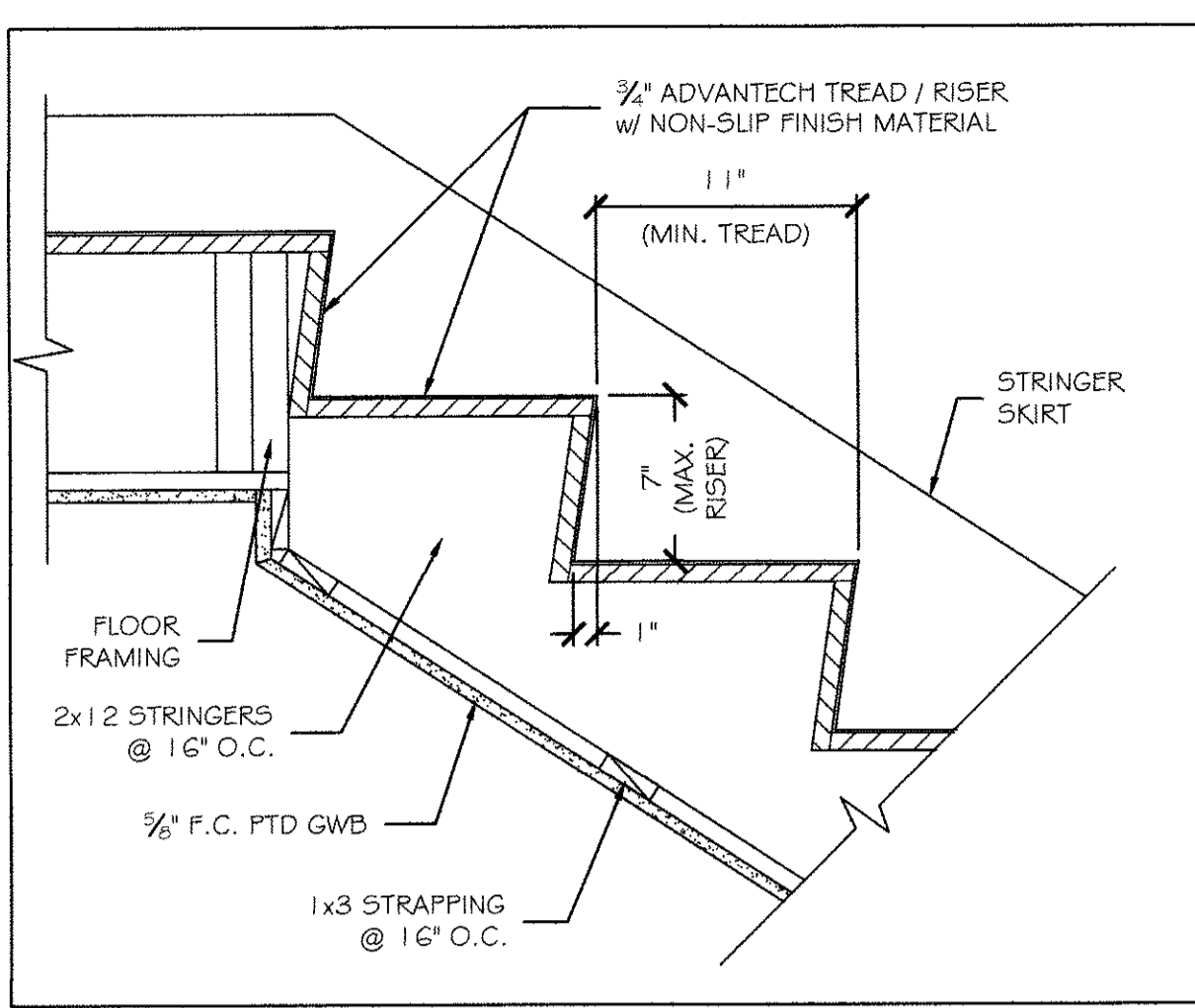

1 INTERIOR STAIR RISER / TREAD DETAIL 1/2" = 1'-0"

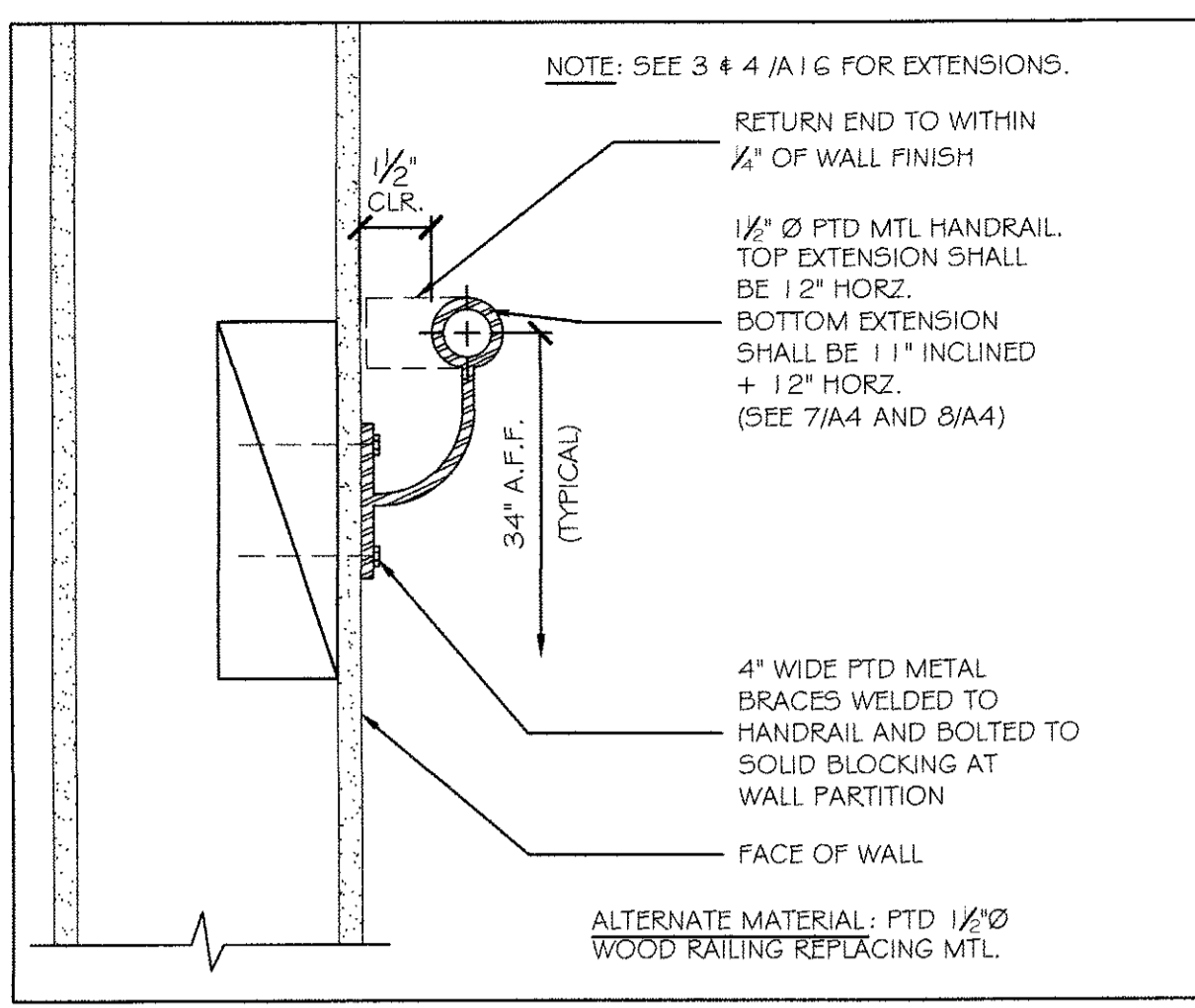

2 TYPICAL WALL HANDRAIL SECTION 3" = 1'-0"

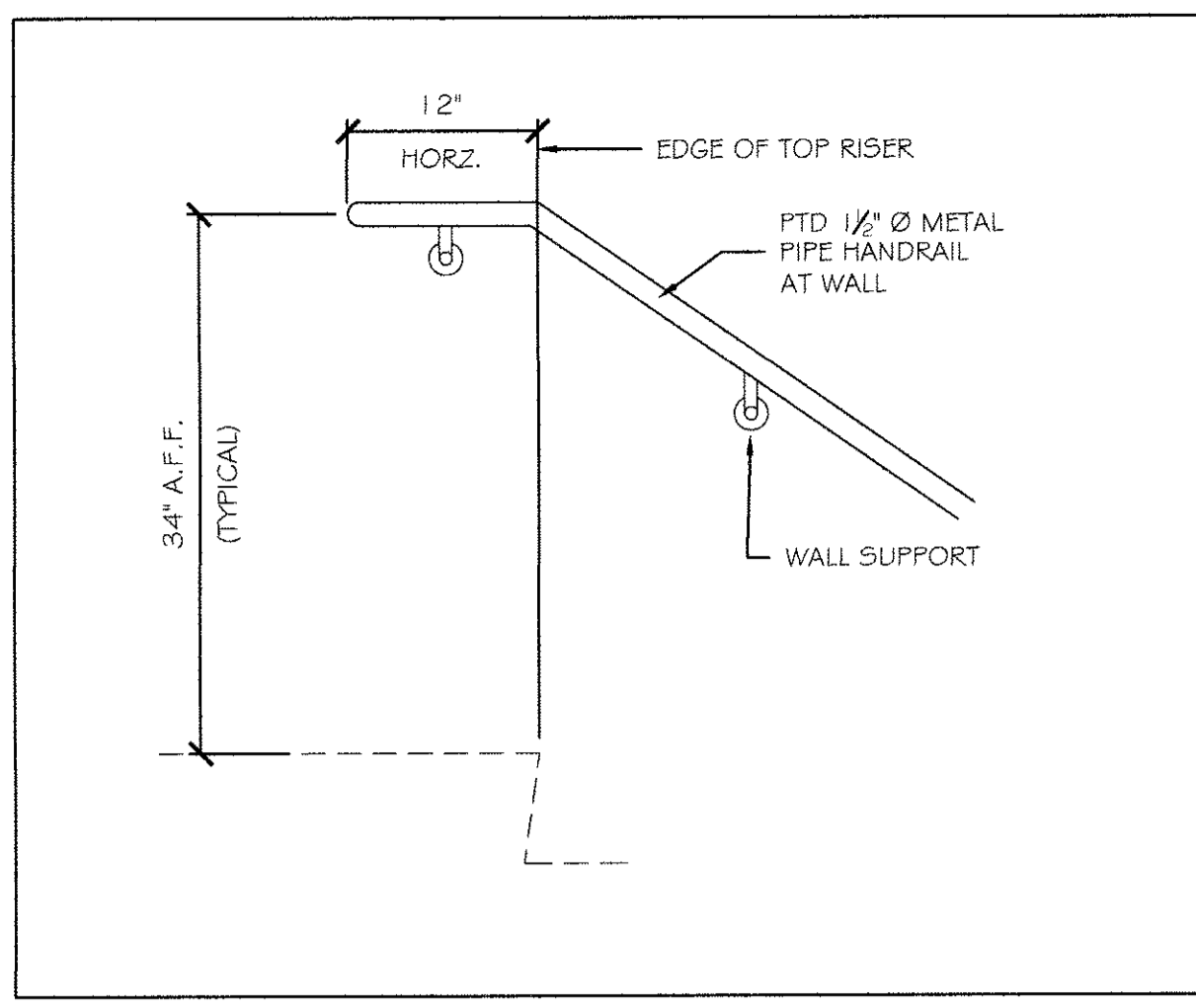

3 TYPICAL WALL HANDRAIL - TOP 1" = 1'-0"

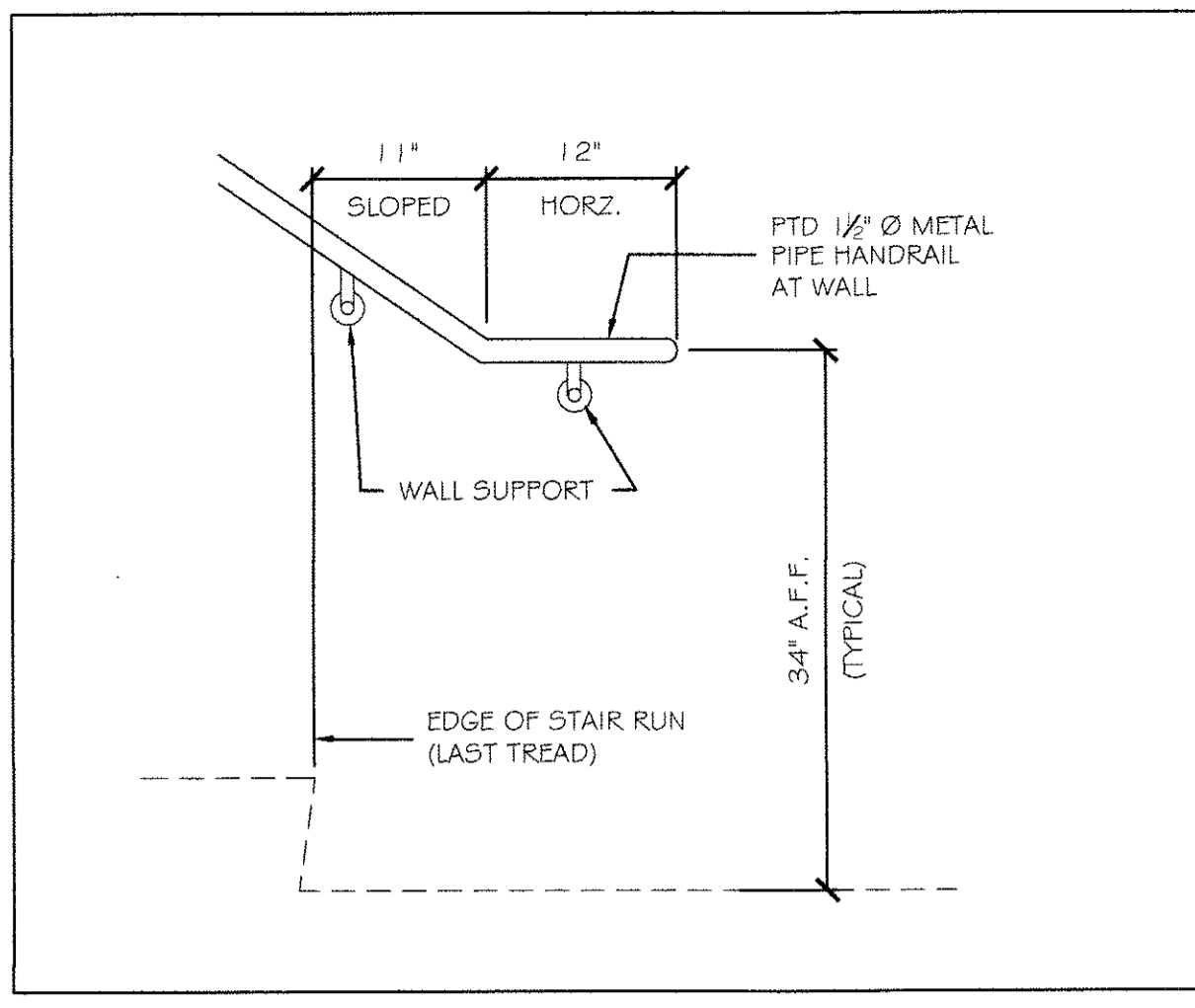

4 TYPICAL WALL HANDRAIL - BOTTOM 1" = 1'-0"

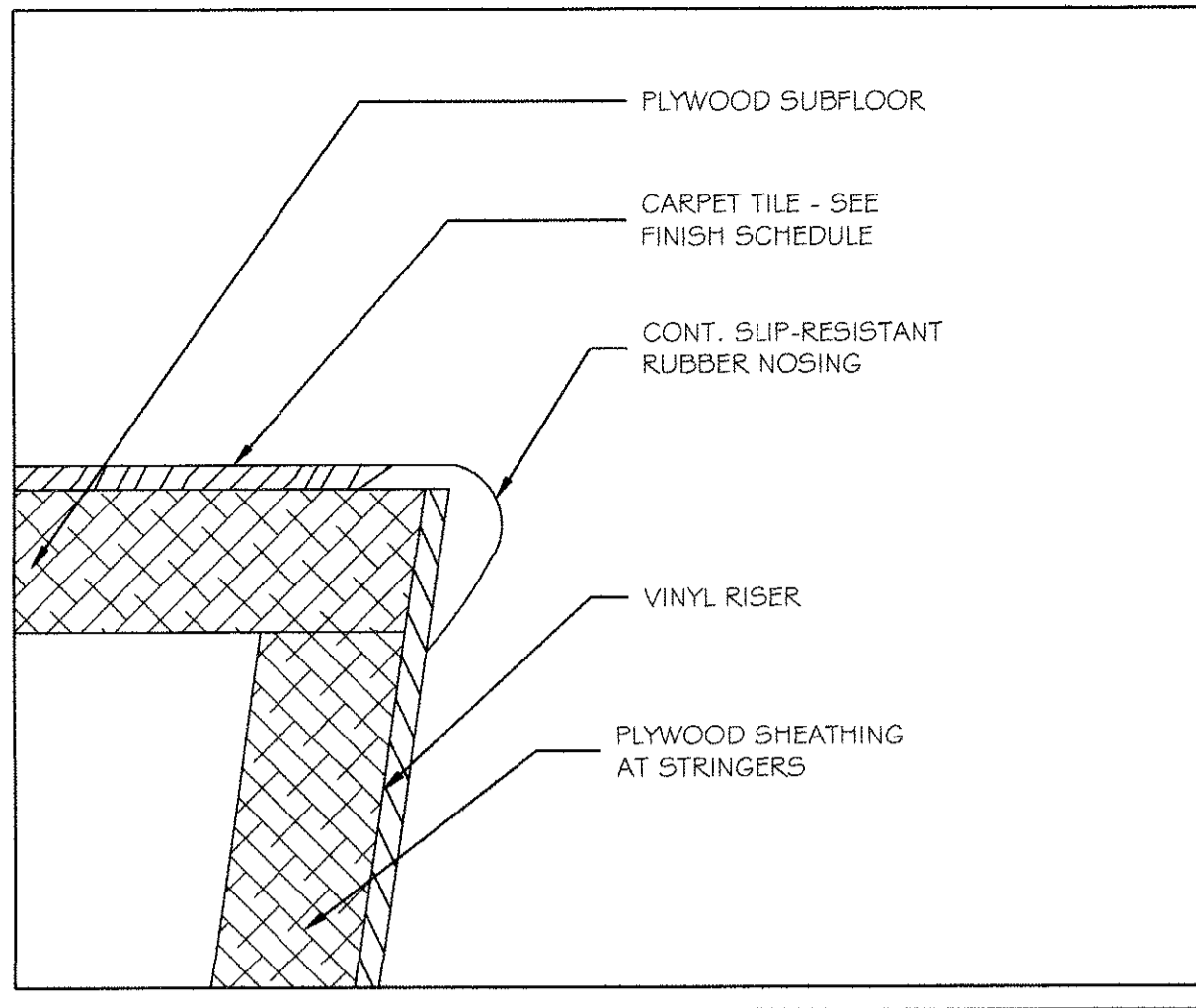

5 STAIR NOSING DETAIL FULL SIZE

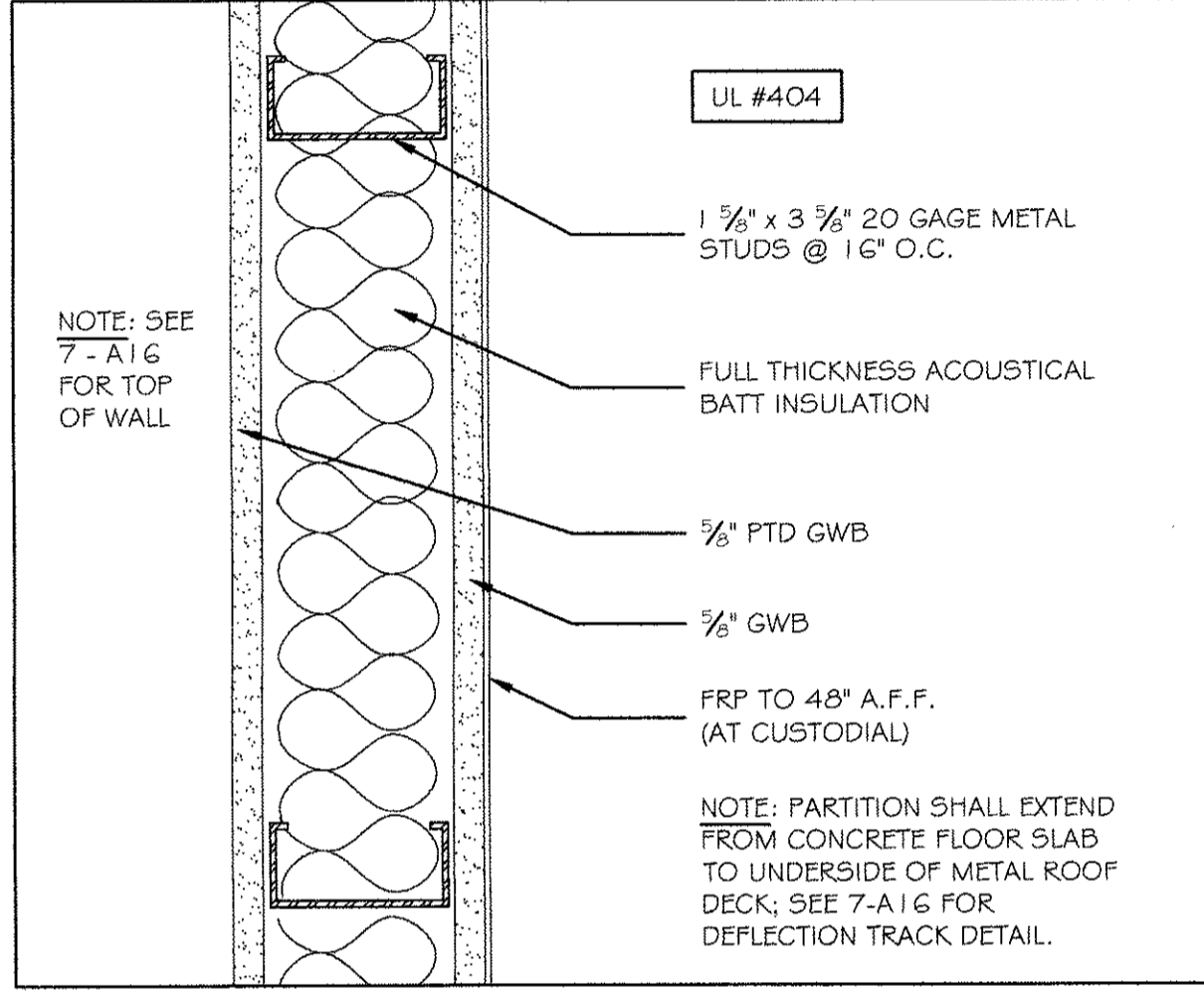

6 TYPICAL PARTITION (1 HR RATED) 3" = 1'-0"

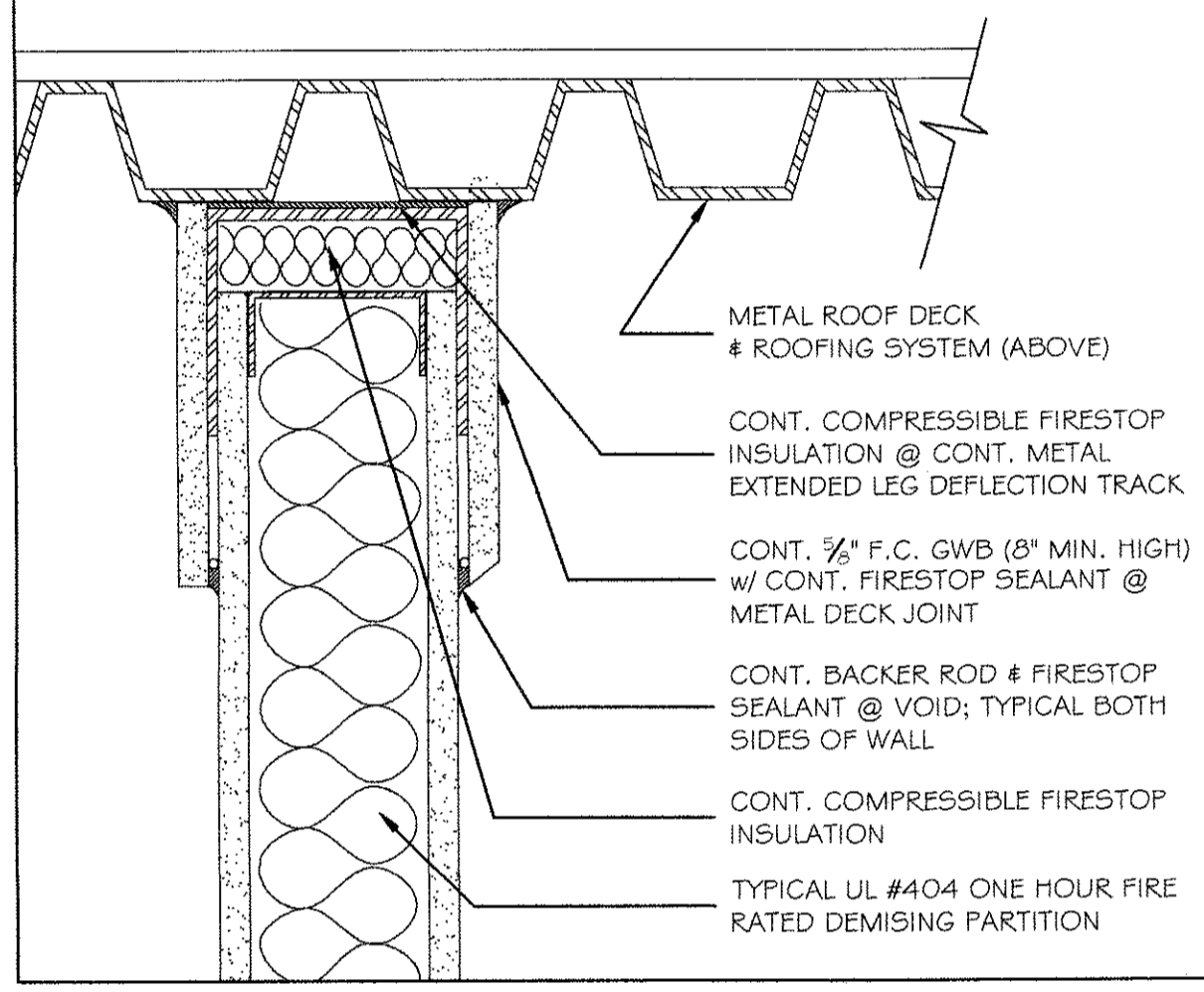

7 1 HR RATED PARTITION @ DEFLECTION TRACK 3" = 1'-0"

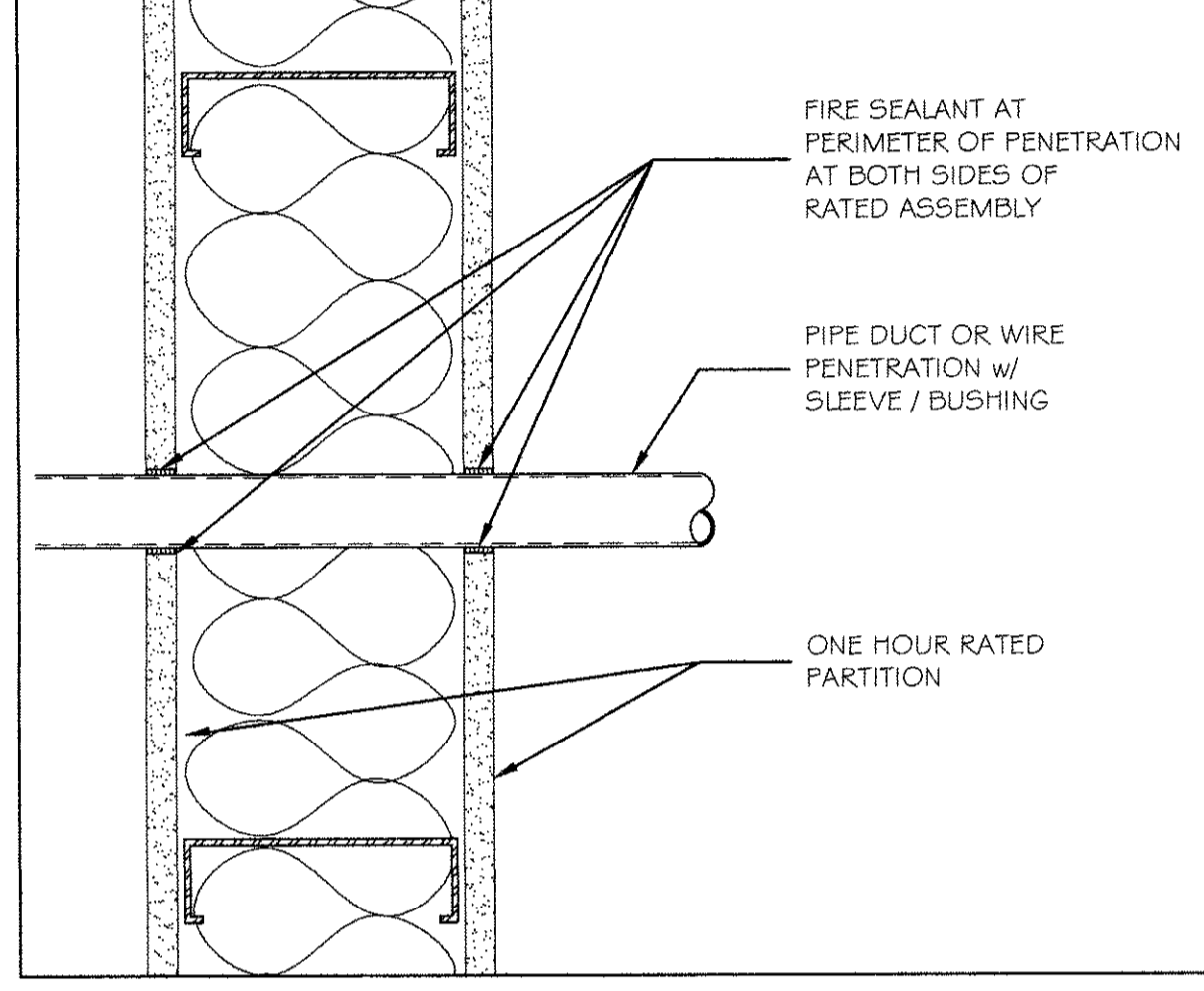

8 FIRE SEALANT AT PENETRATIONS 3" = 1'-0"

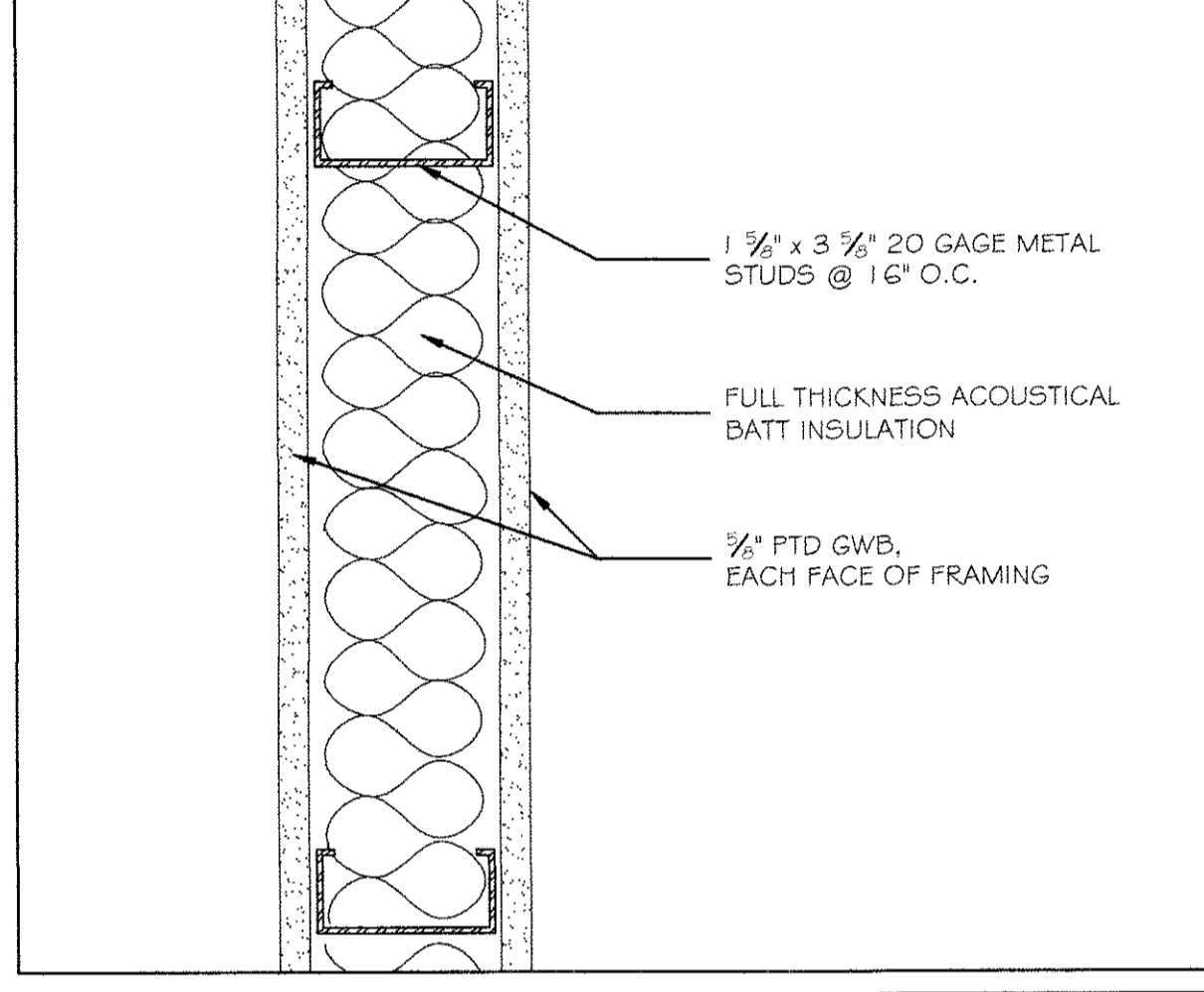

9 TYPICAL PARTITION 3" = 1'-0"

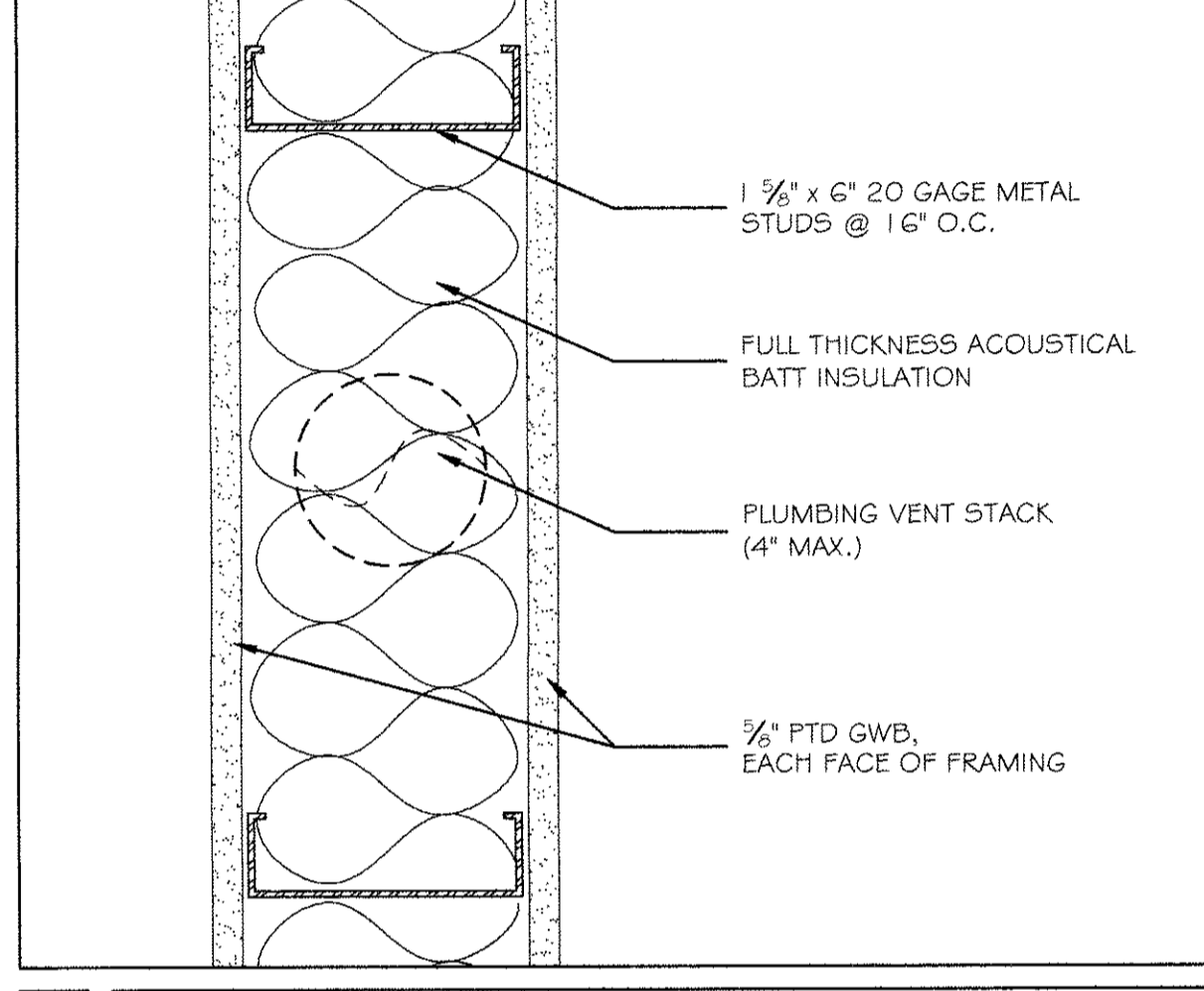

10 TYPICAL PARTITION 3" = 1'-0"

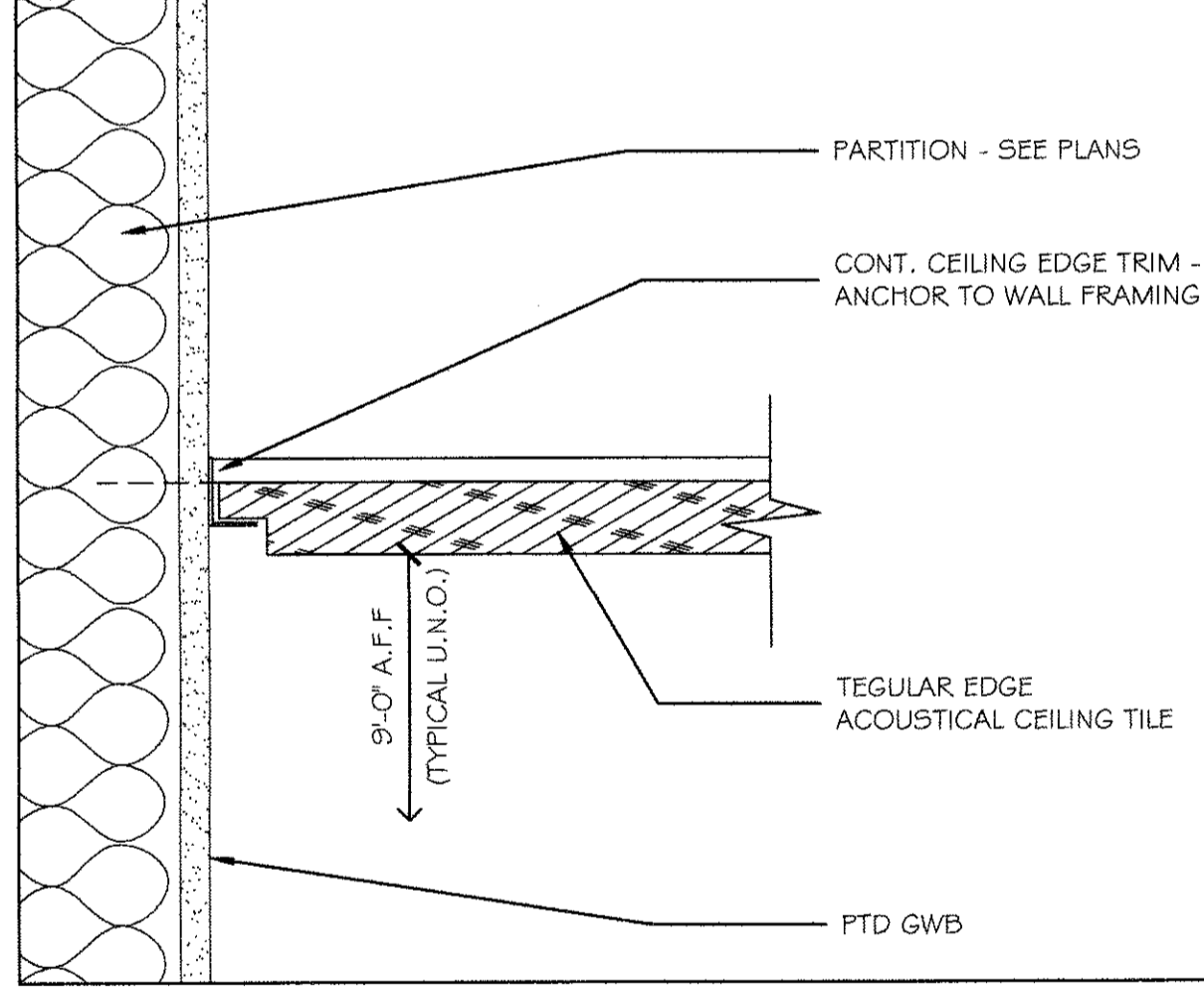

11 TYPICAL SAT DETAIL 3" = 1'-0"

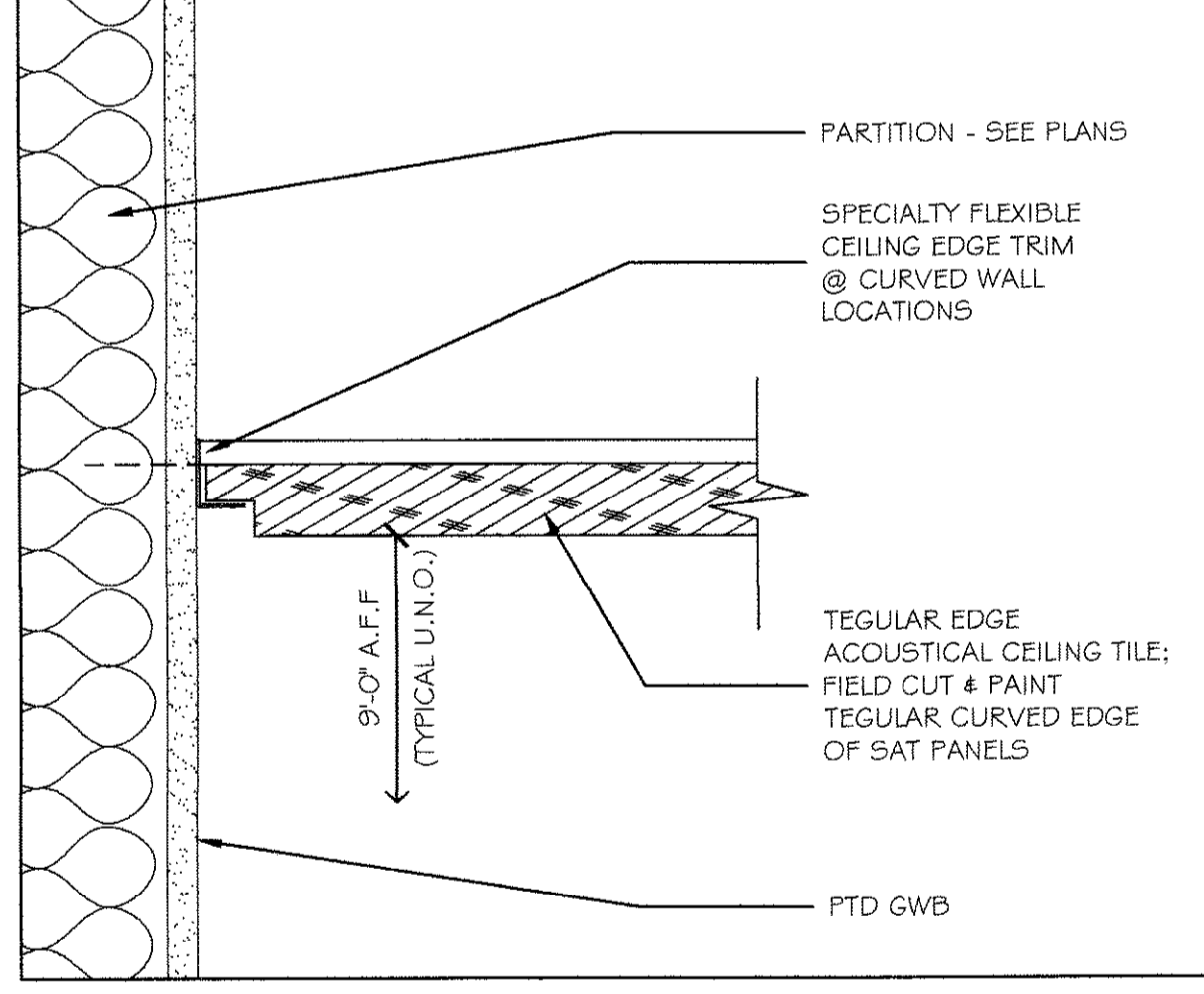

12 SAT DETAIL @ CURVED WALLS 3" = 1'-0"

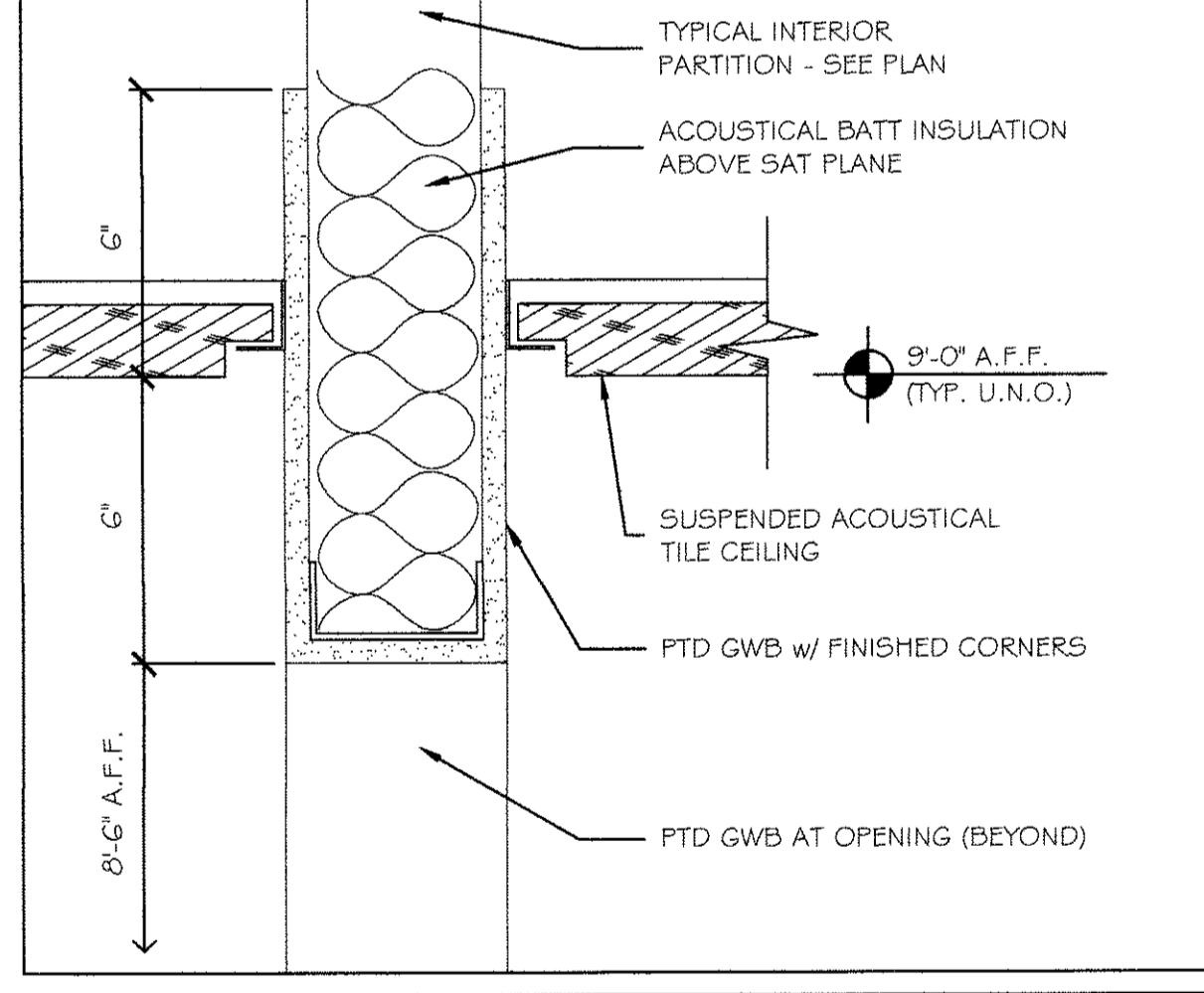

13 SAT AT GWB SOFFIT DETAIL 3" = 1'-0"

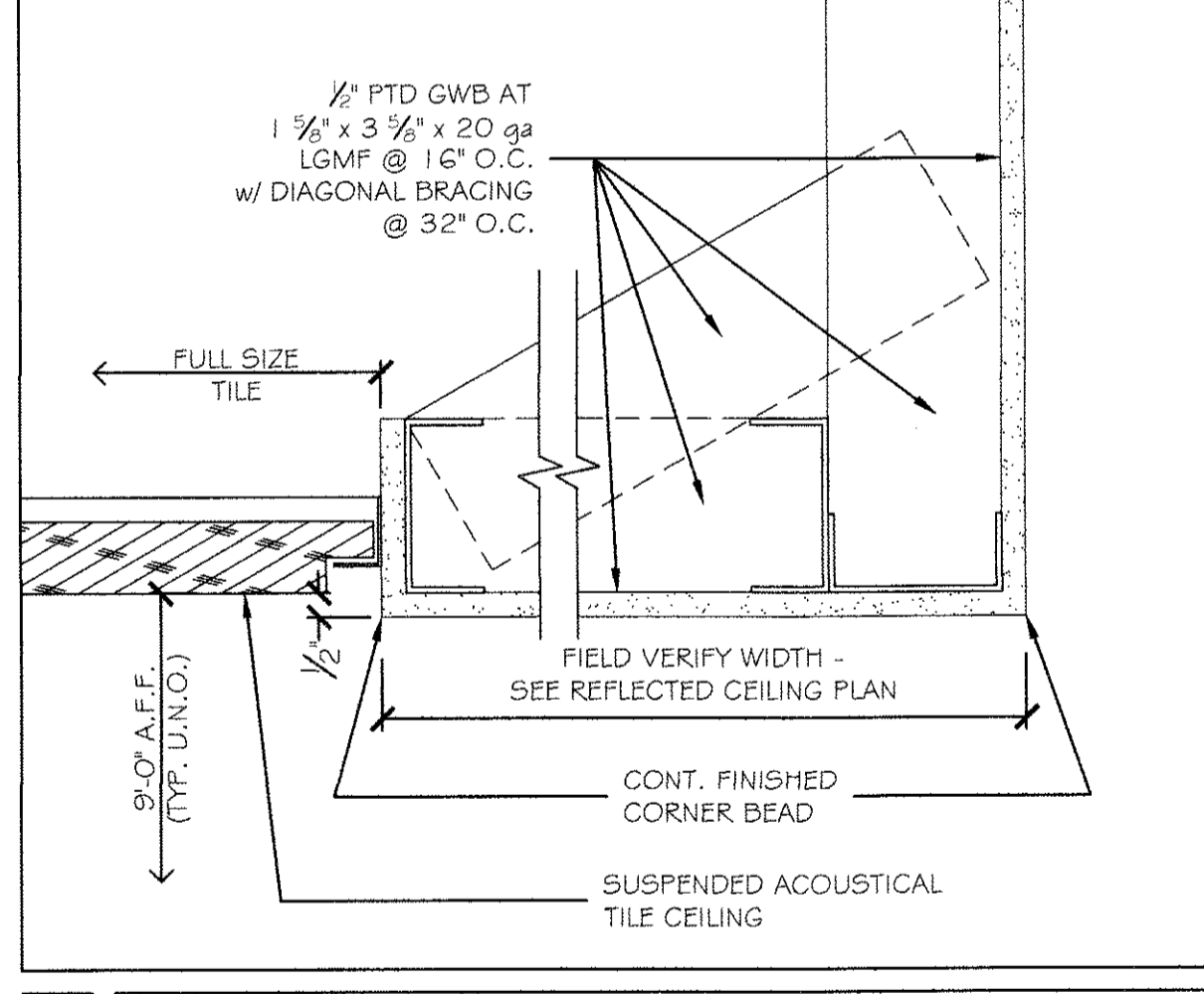

14 SAT AT GWB SOFFIT DETAIL 3" = 1'-0"

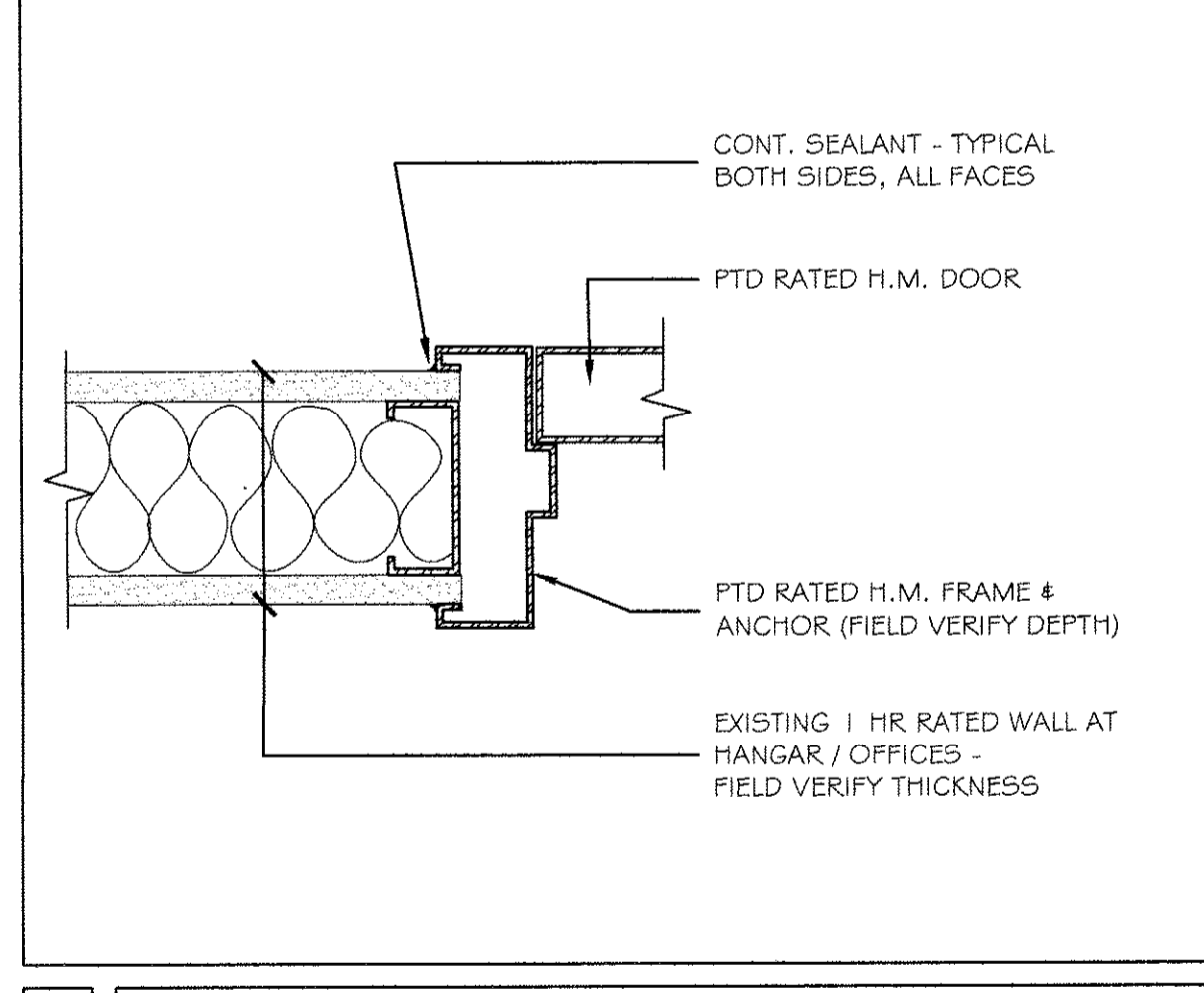

15 NEW RATED DOOR AT EXISTING PARTITION 3" = 1'-0"

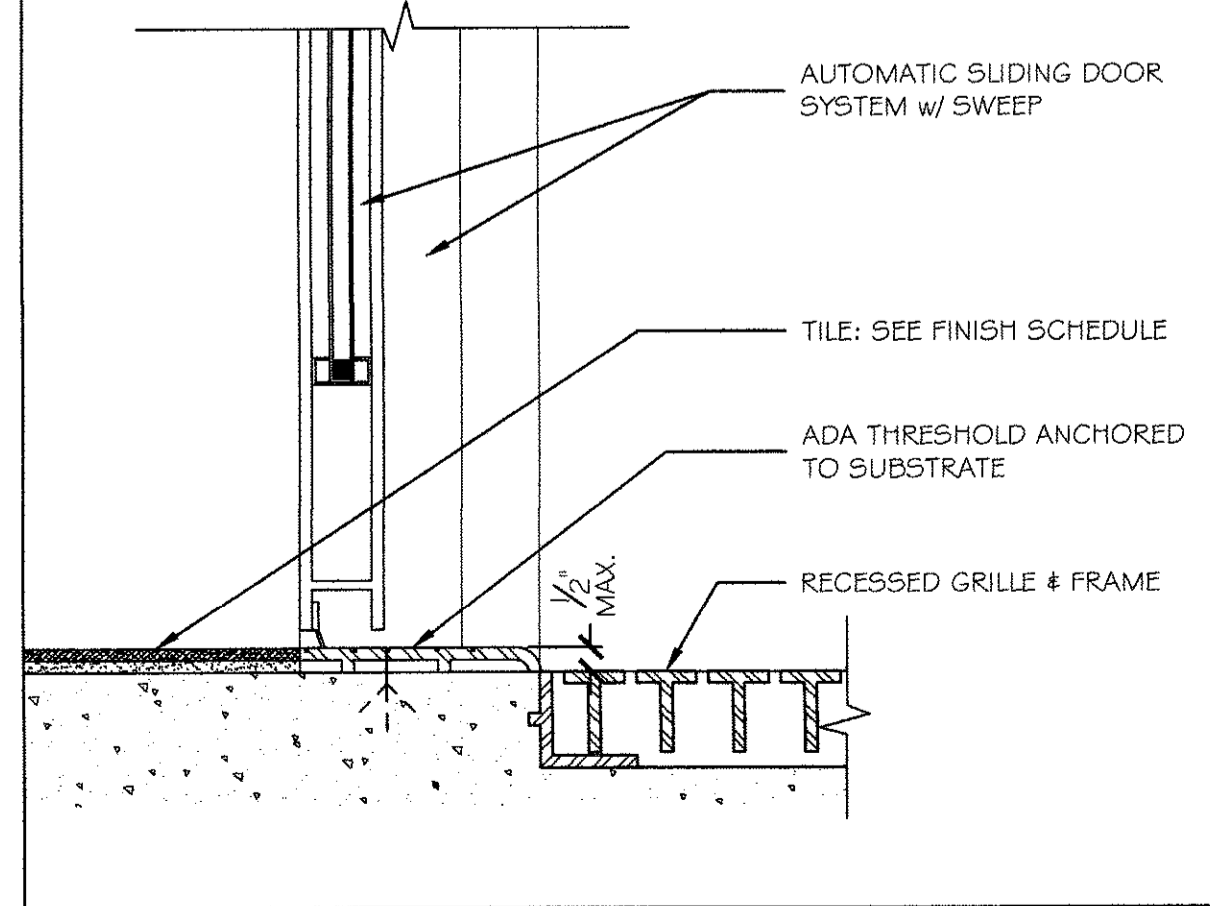

16 INTERIOR SILL DETAIL AT DOOR 3" = 1'-0"

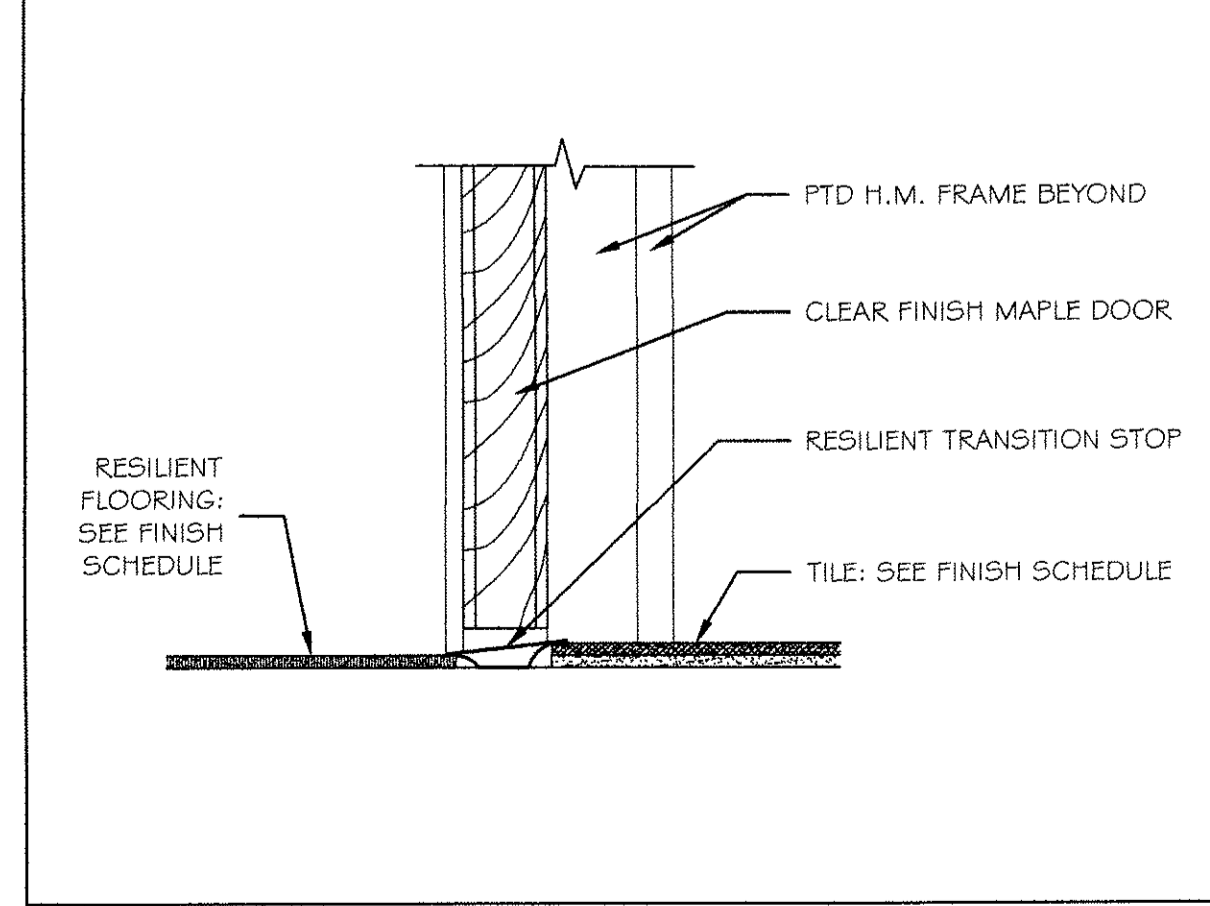

17 INTERIOR SILL DETAIL AT DOOR 3" = 1'-0"

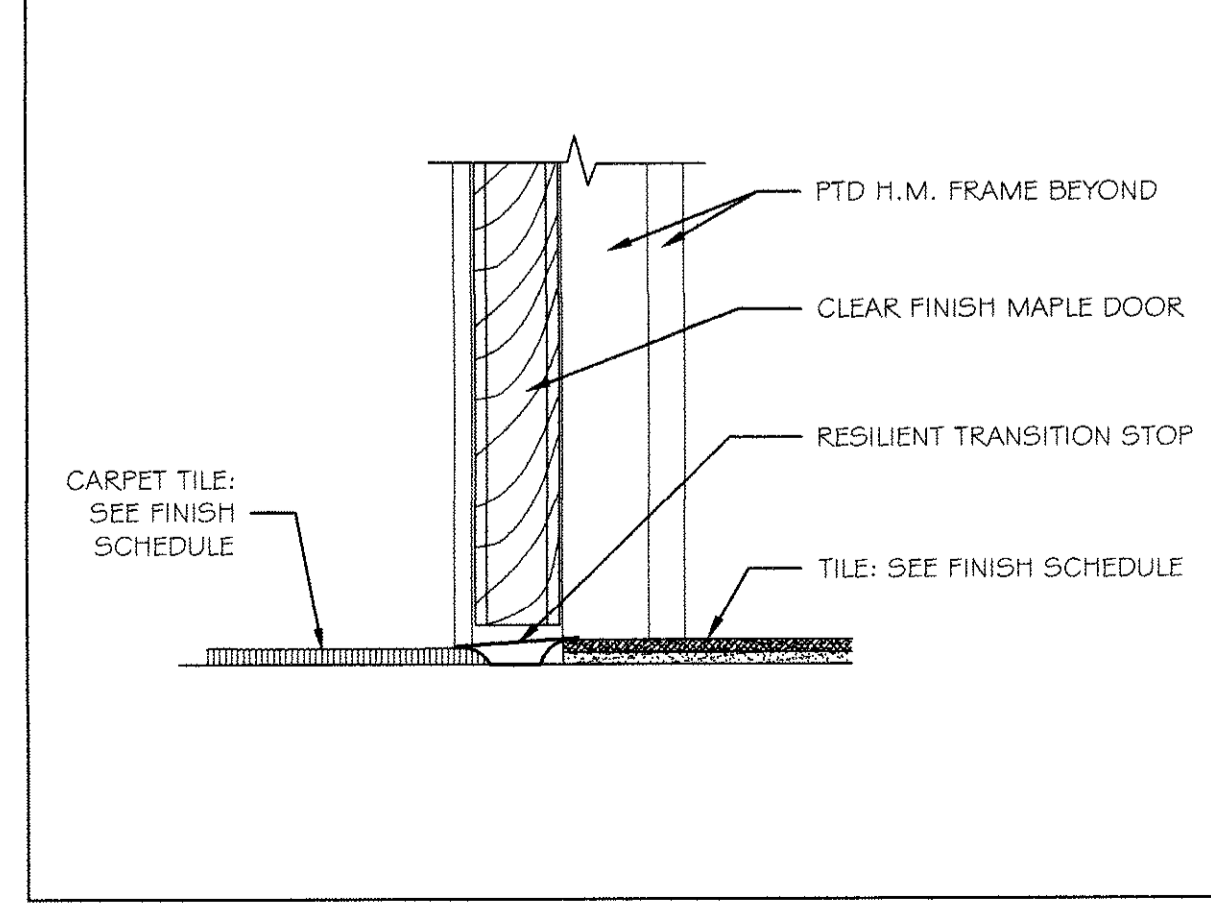

18 INTERIOR SILL DETAIL AT DOOR 3" = 1'-0"

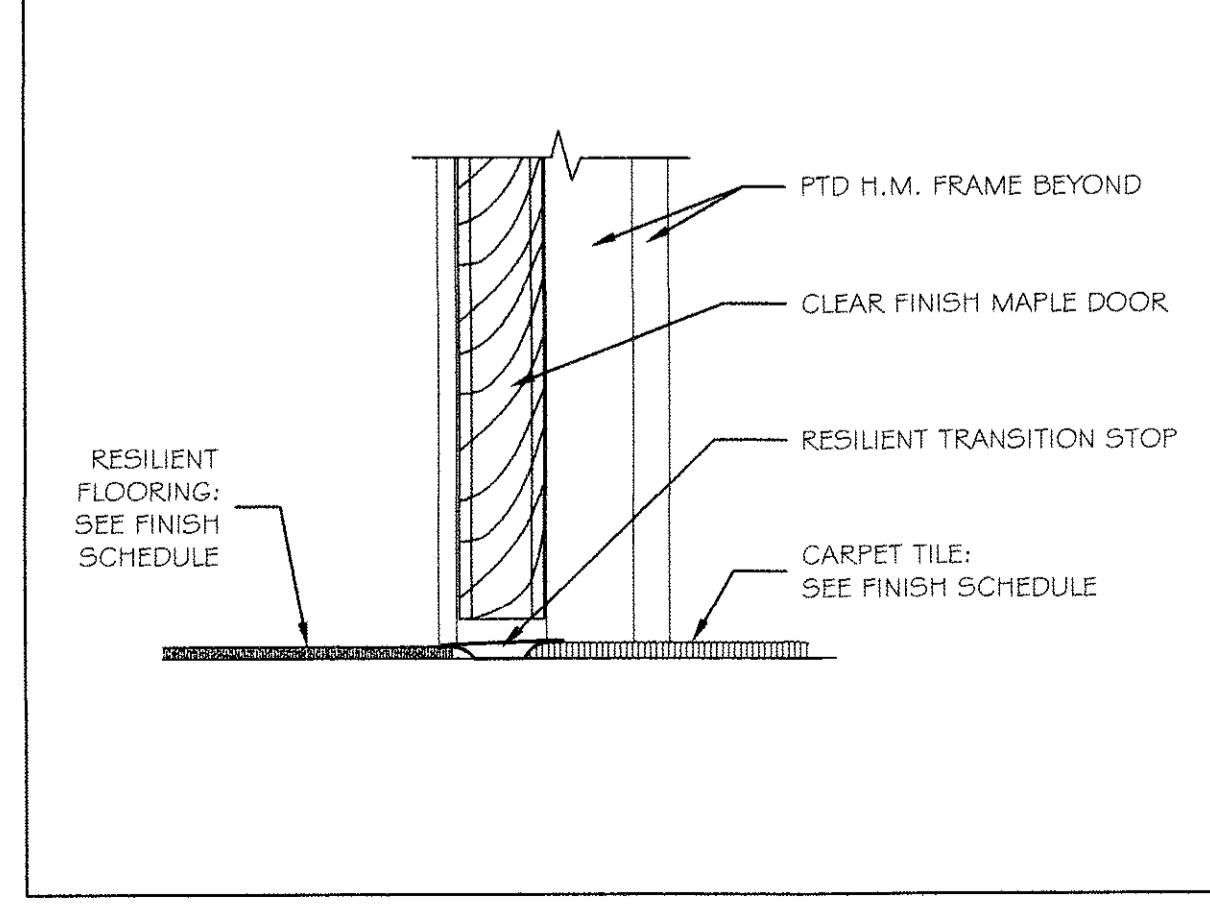

19 INTERIOR SILL DETAIL AT DOOR 3" = 1'-0"

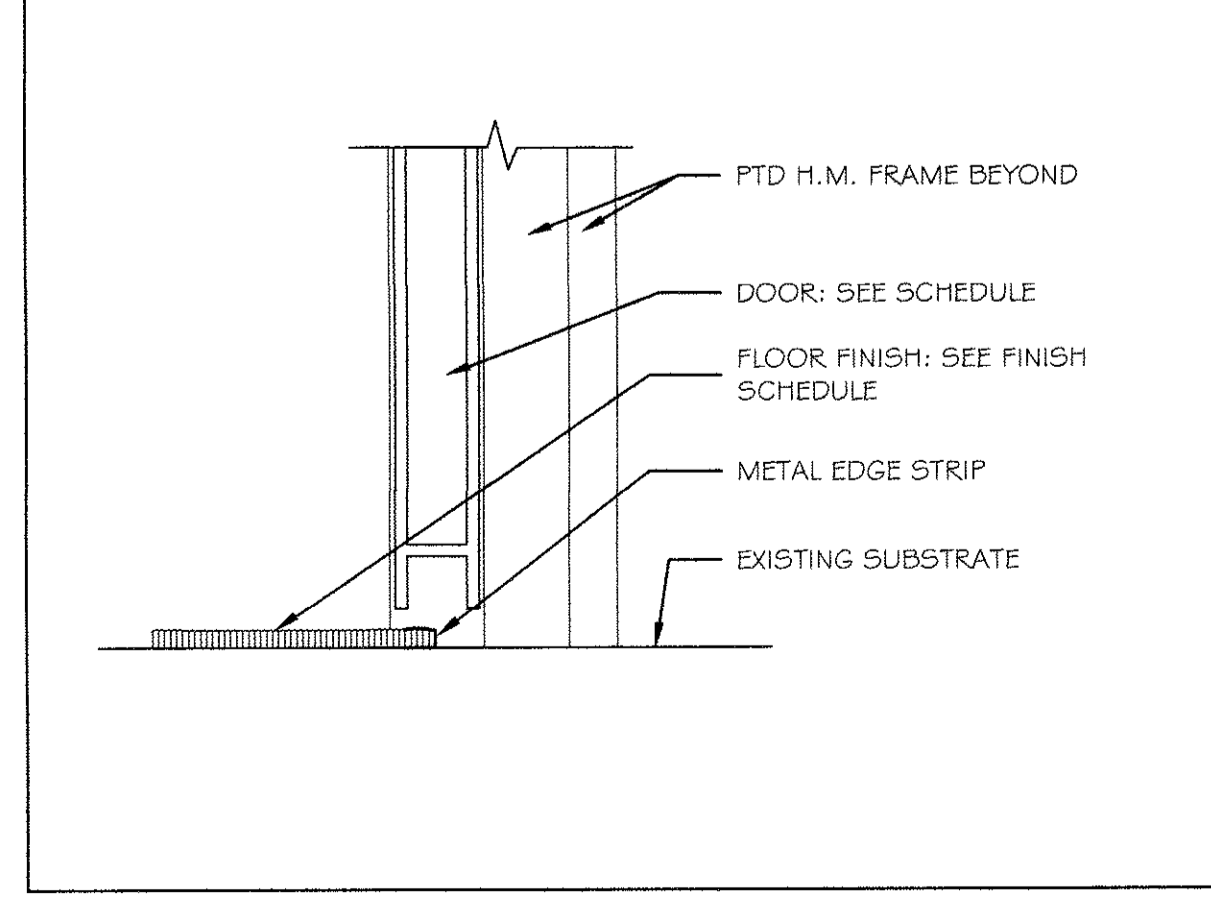

20 INTERIOR SILL DETAIL AT DOOR 3" = 1'-0"