

GARAGE VESTIBULE END MULLION
SCALE: 3" = 1'-0" A09.23

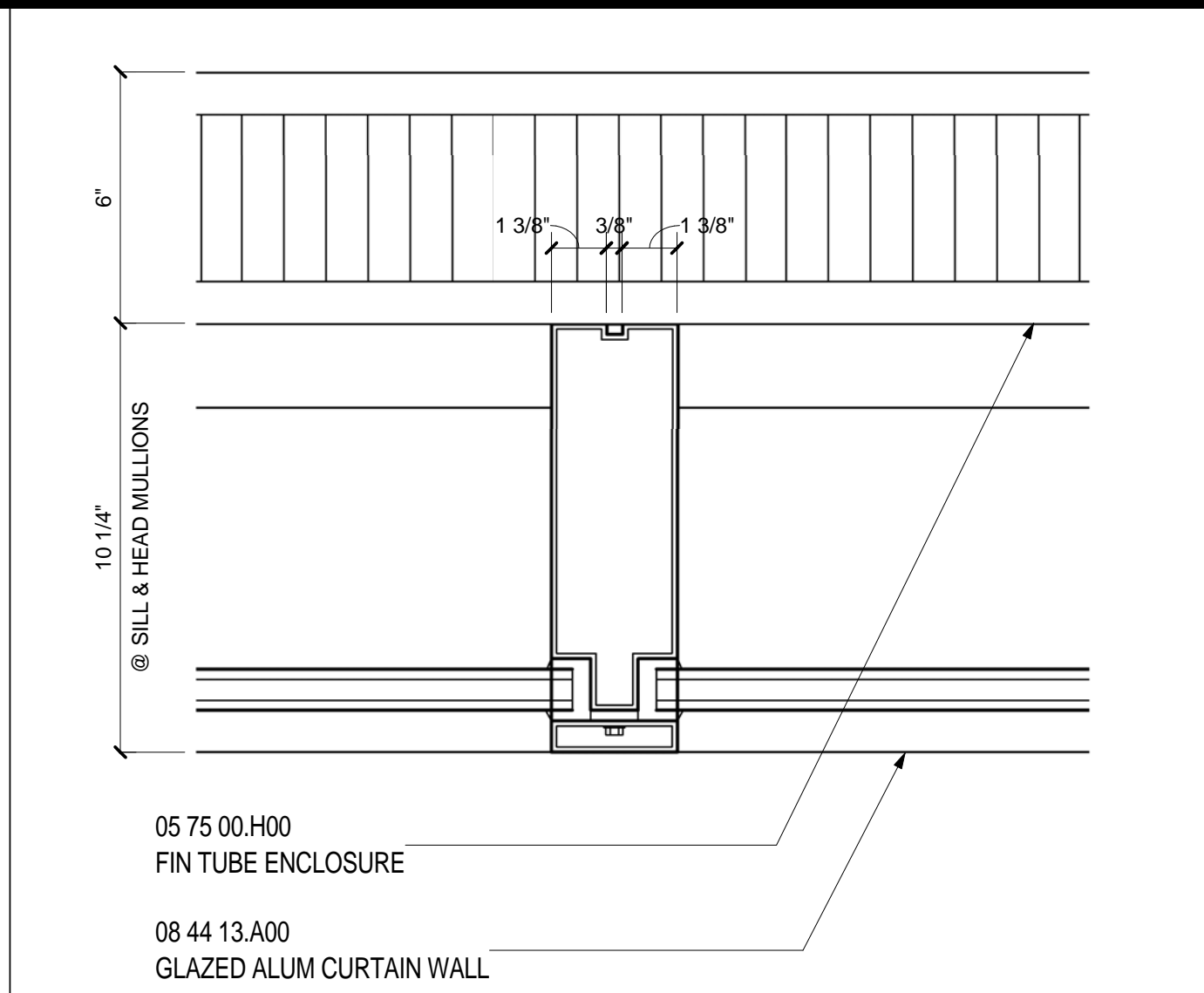

WALL TYP B - ALUM. MULLION TYP
SCALE: 3" = 1'-0" A09.30

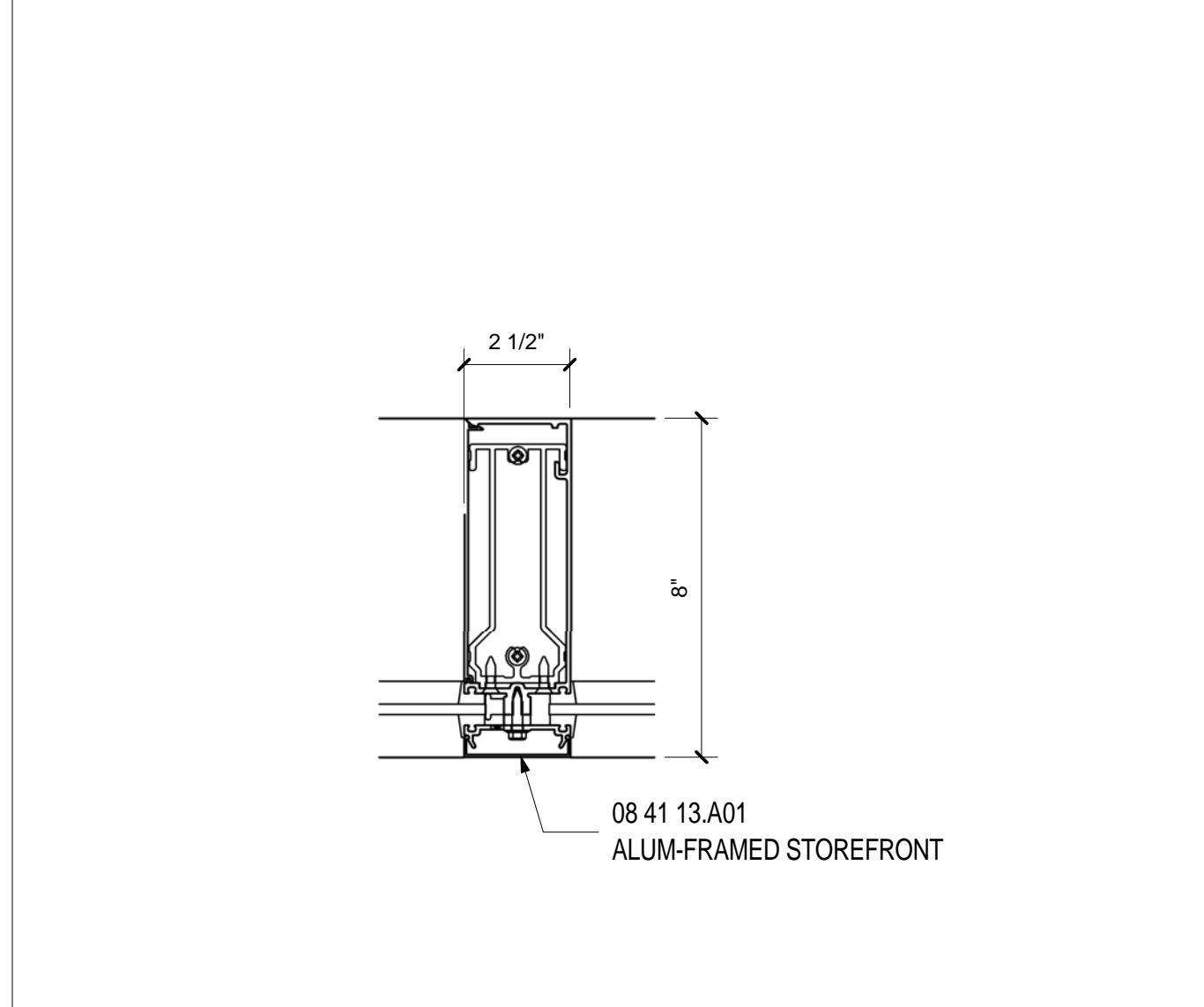

GARAGE VESTIBULE MULLION
SCALE: 3" = 1'-0" A11.24

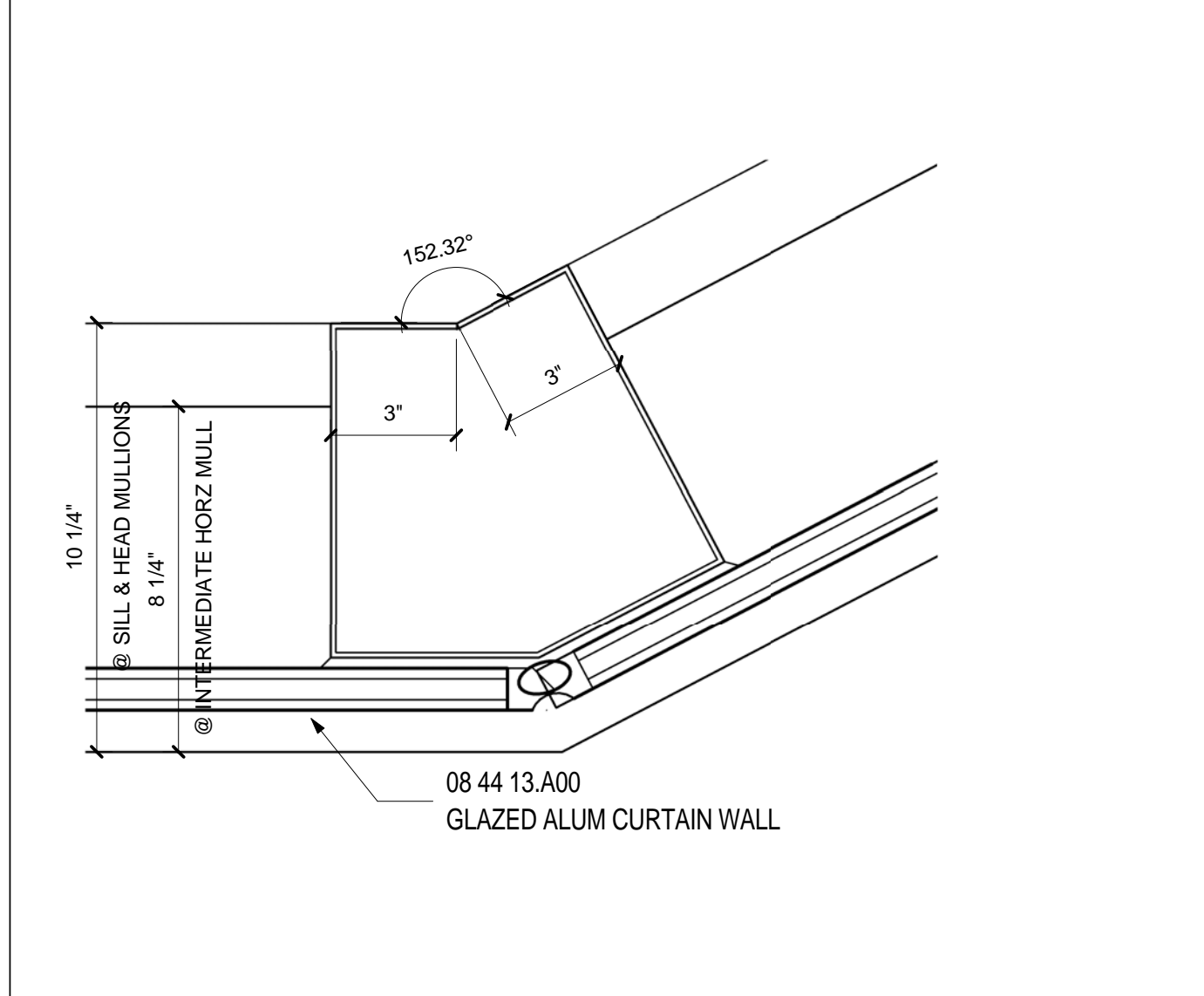

WALL TYPE B LVL 5 CORNER MULLION
SCALE: 3" = 1'-0" A09.31

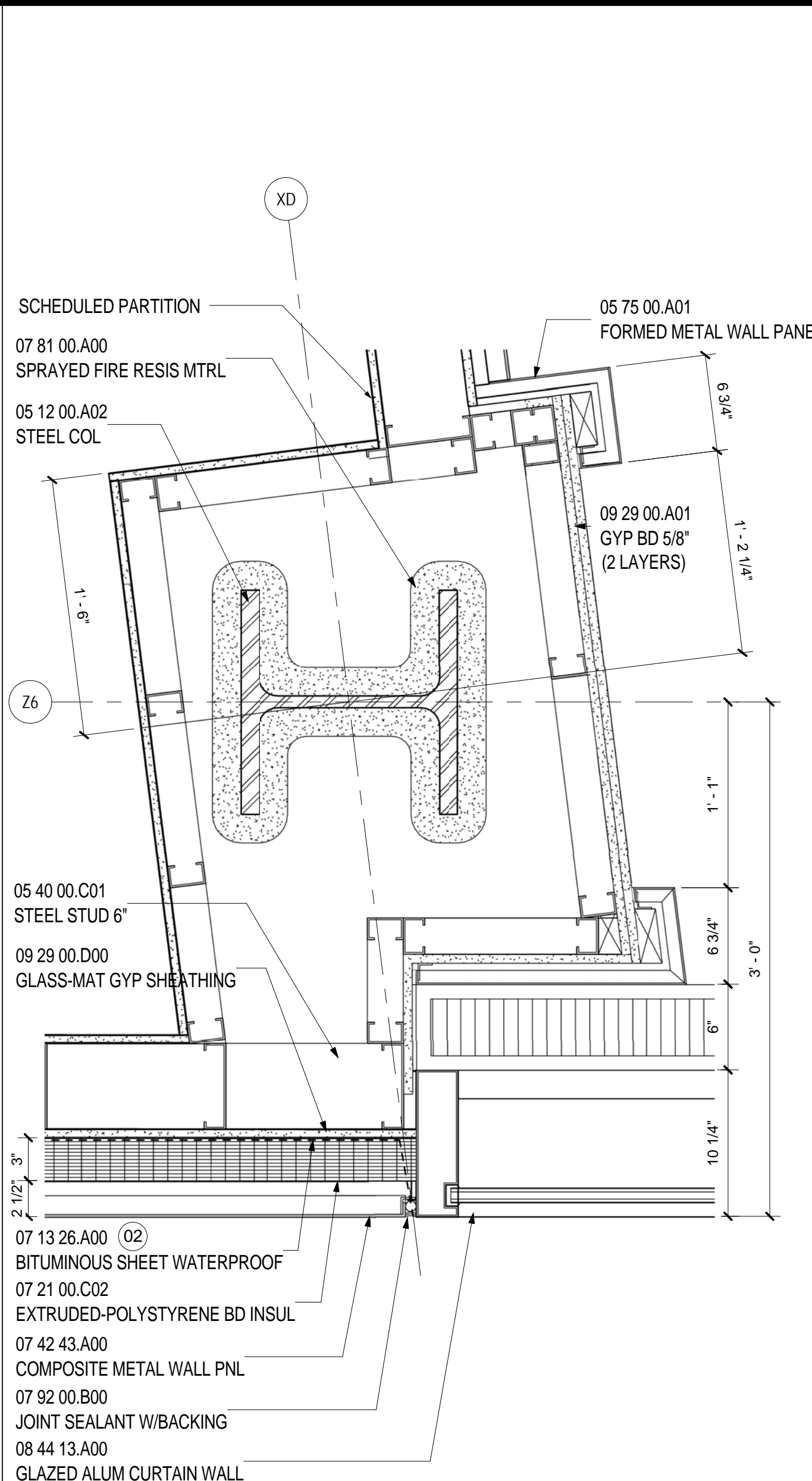

WALL TYPE B LVL 4 - TRANSITION B
SCALE: 1 1/2" = 1'-0" A09.35

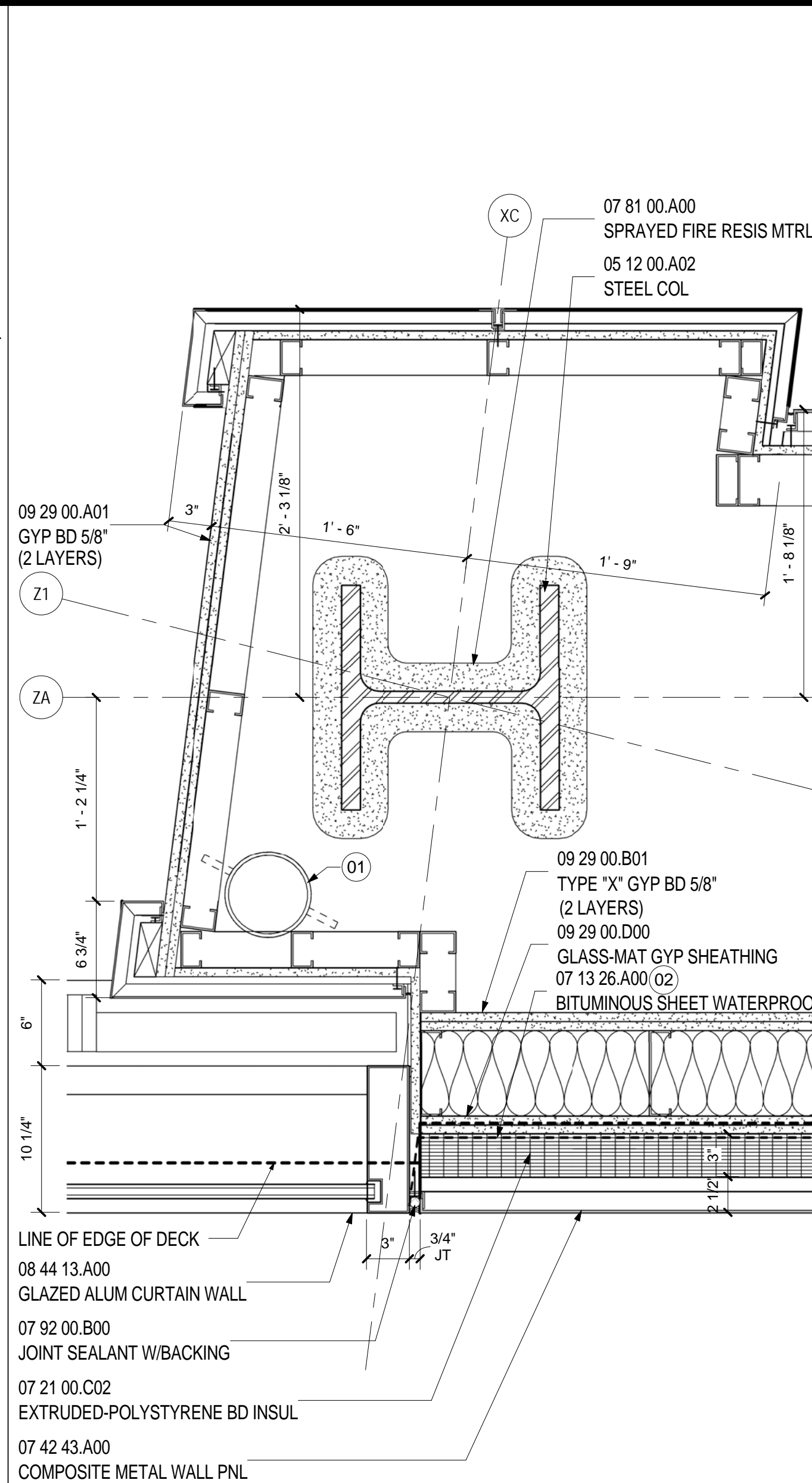

WALL TYPE B LVL 4 TRANSITION A
SCALE: 1 1/2" = 1'-0" A09.30

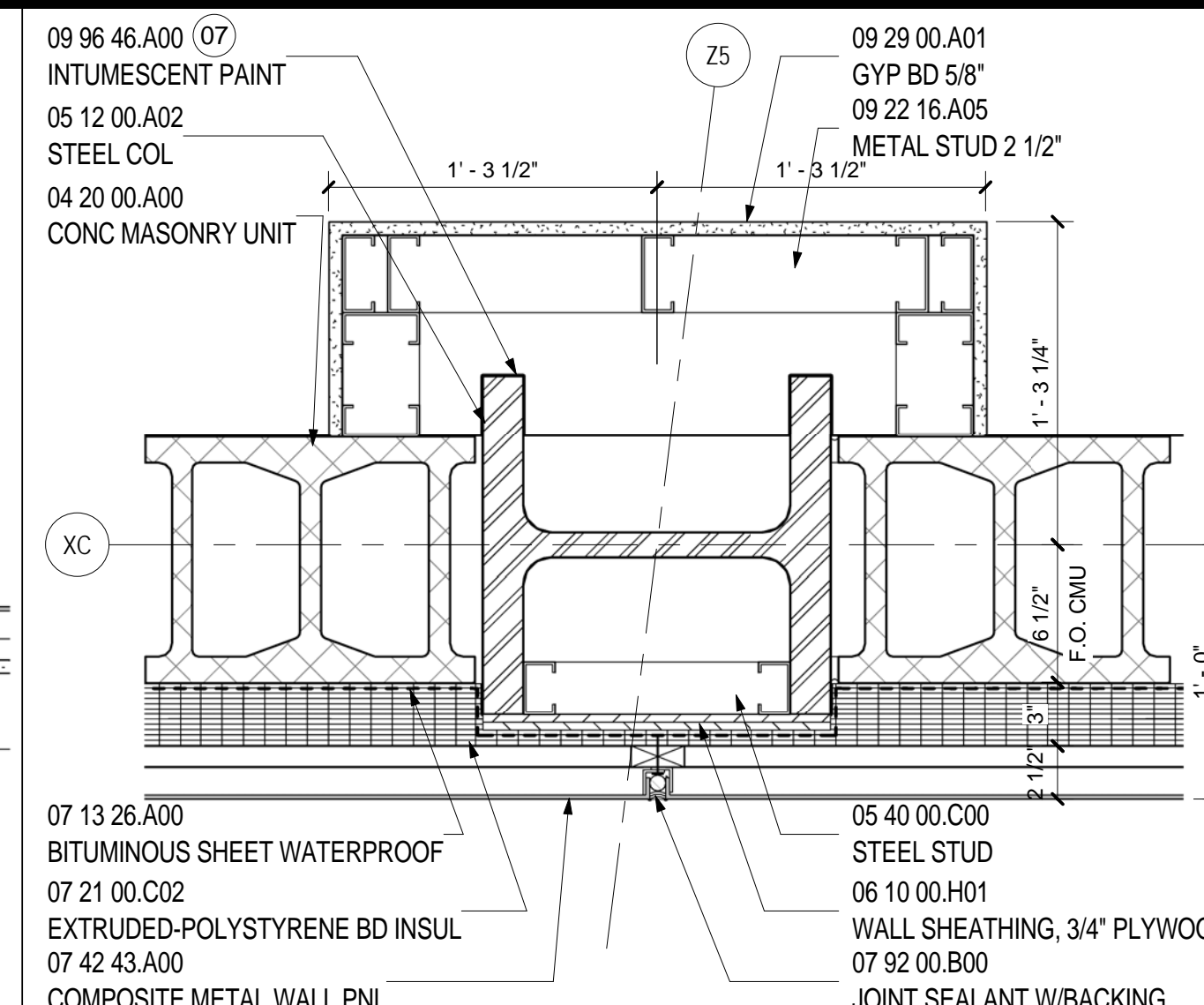

WALL TYPE A LVL 2 COL CVR
SCALE: 1 1/2" = 1'-0" A09.21

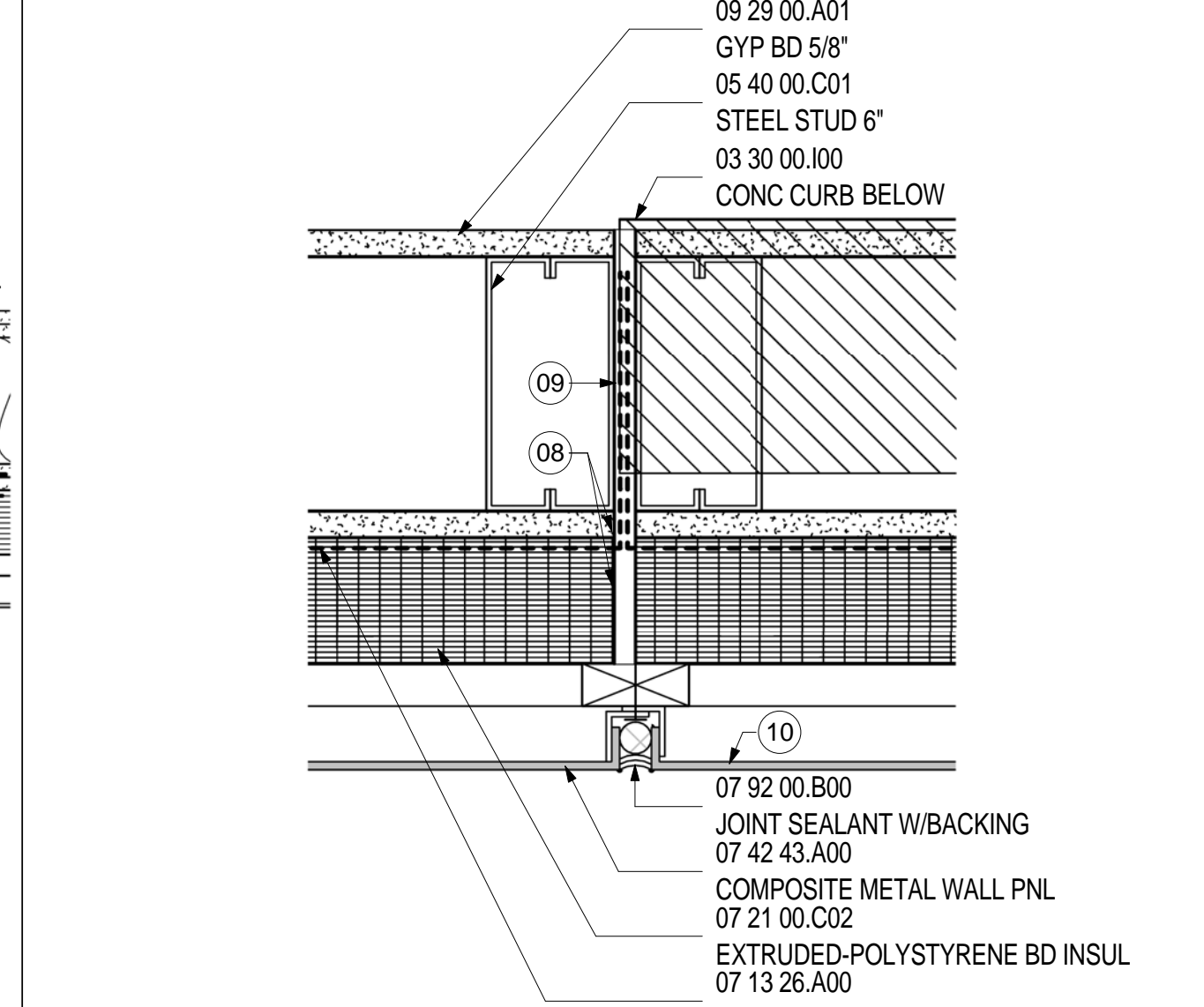

WALL TYPE A ACCESS PANEL
SCALE: 3" = 1'-0" A09.21

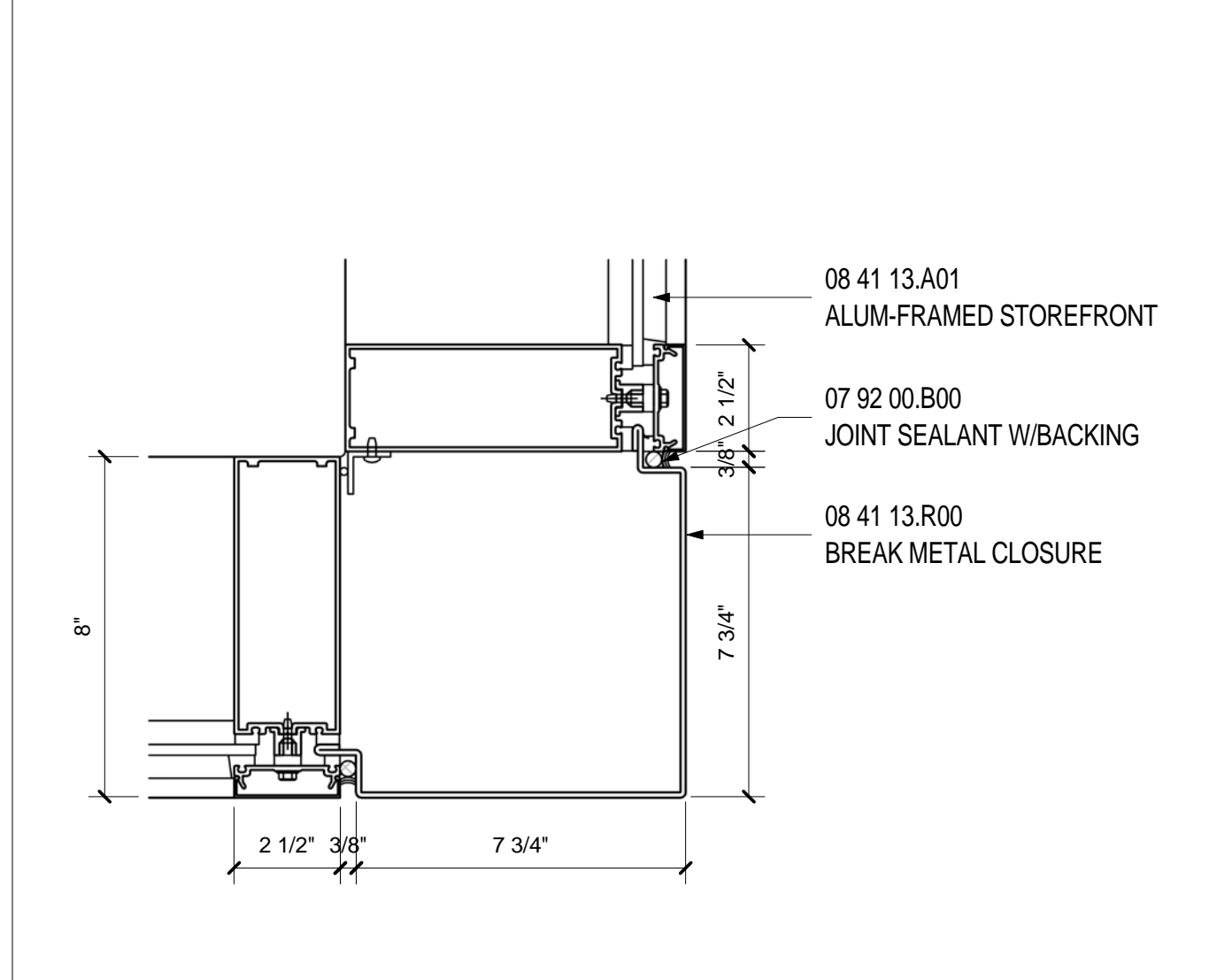

GARAGE VESTIBULE CORNER DTL
SCALE: 3" = 1'-0" A09.23

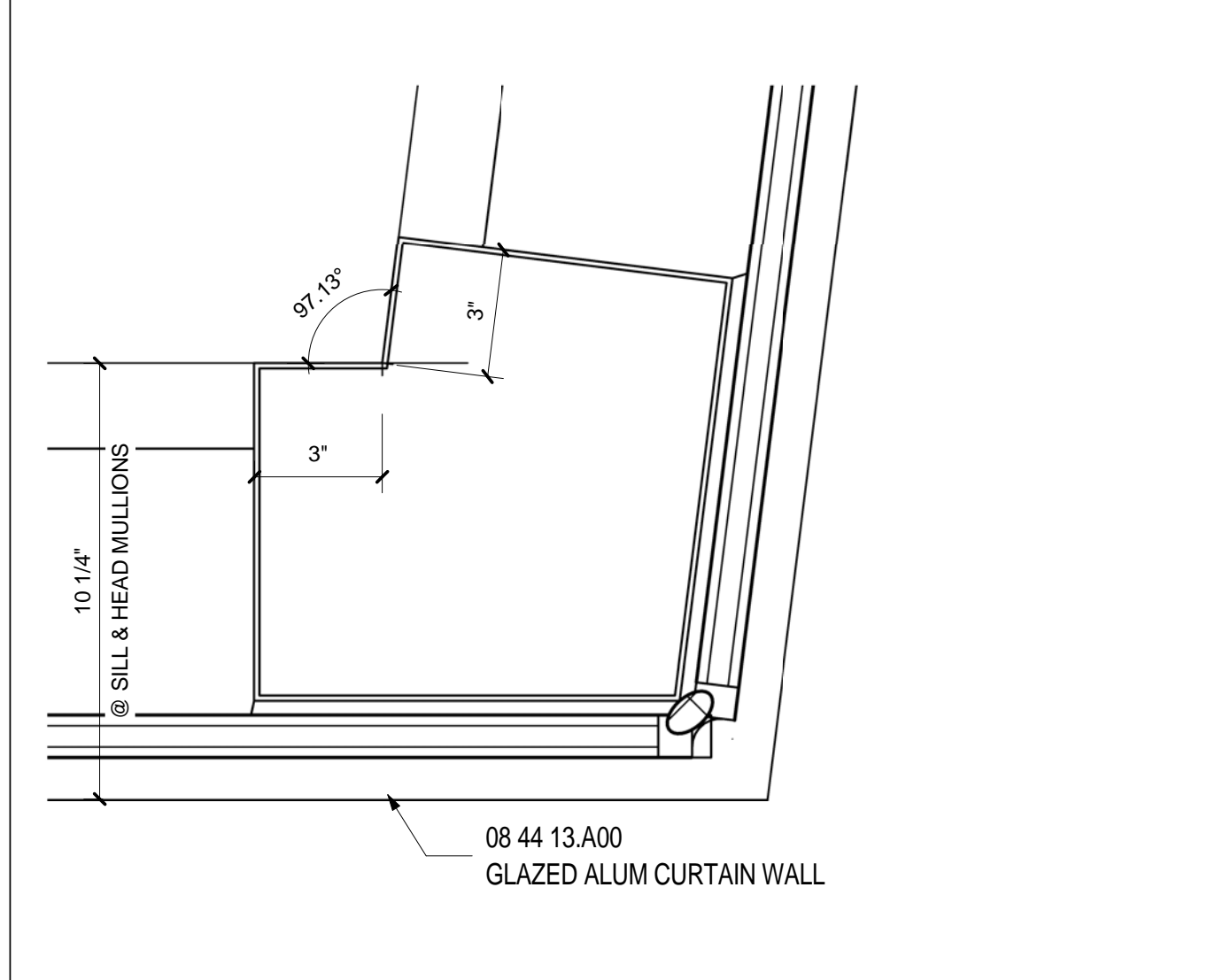

WALL TYPE B LVL 5 CORNER MULLION
SCALE: 3" = 1'-0" A09.22

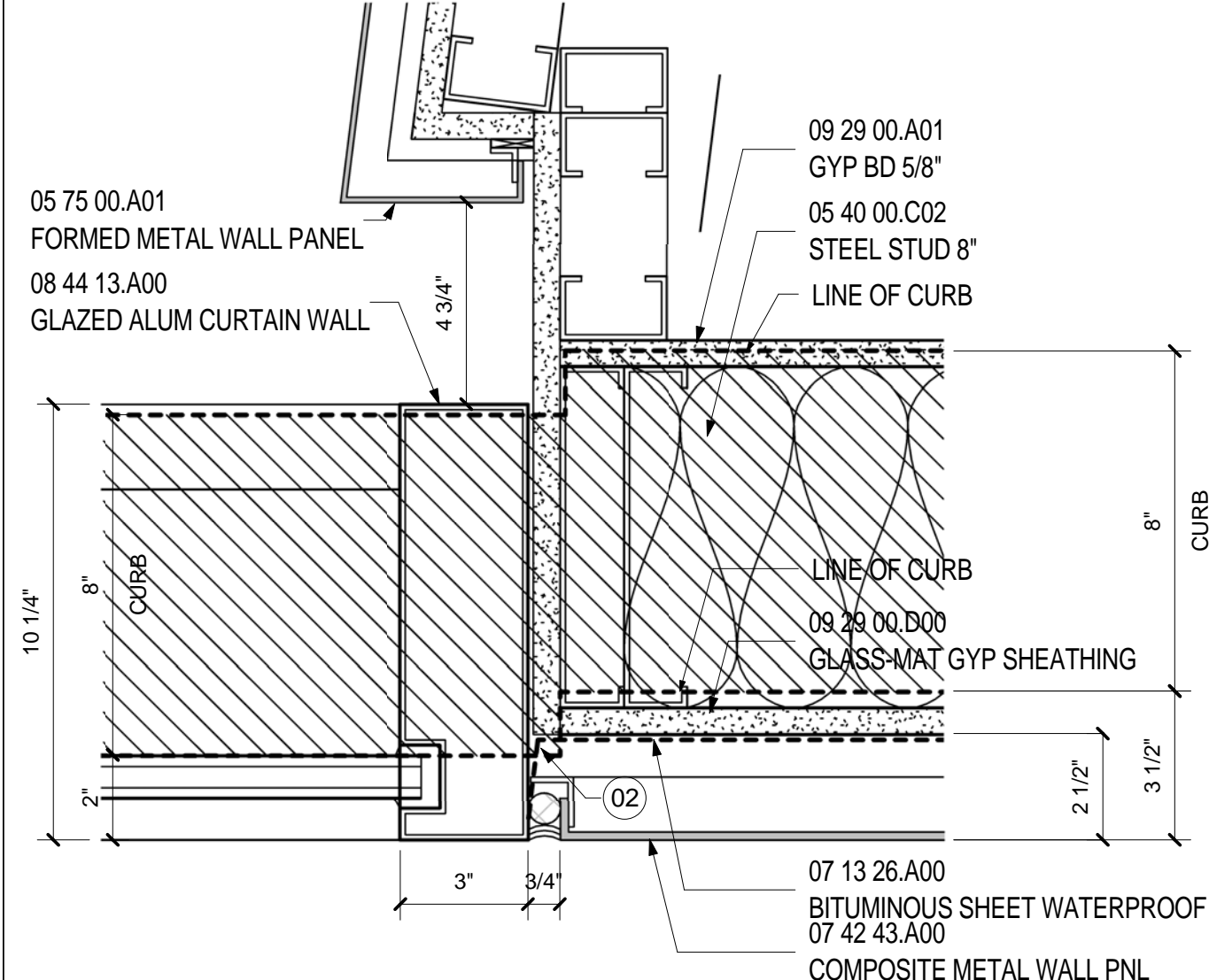

WALL TYPE A LVL 5 GARAGE LINK
SCALE: 3" = 1'-0" A09.22

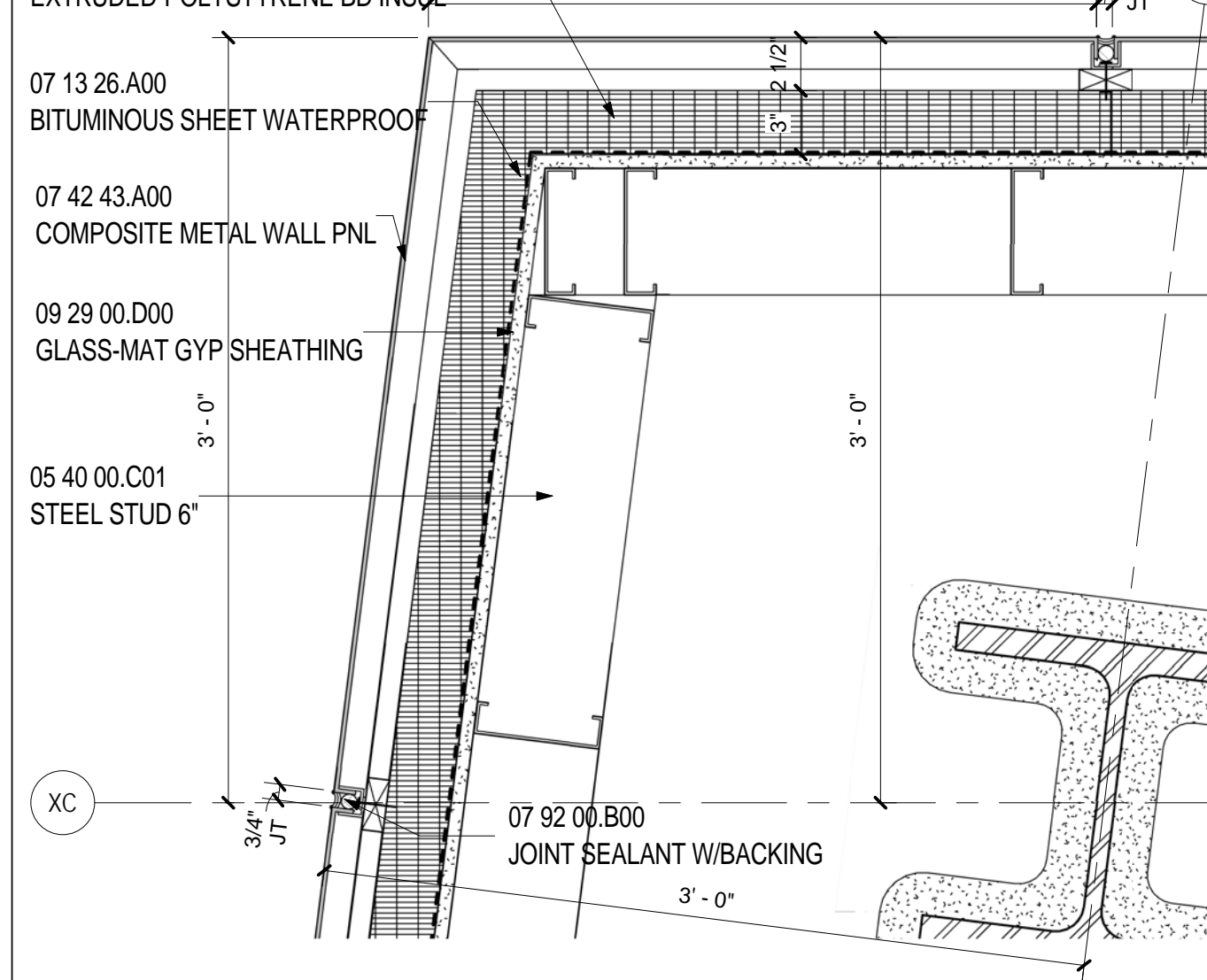

WALL TYPE A LVL 5 OUTSIDE CORNER
SCALE: 1 1/2" = 1'-0" A10.00

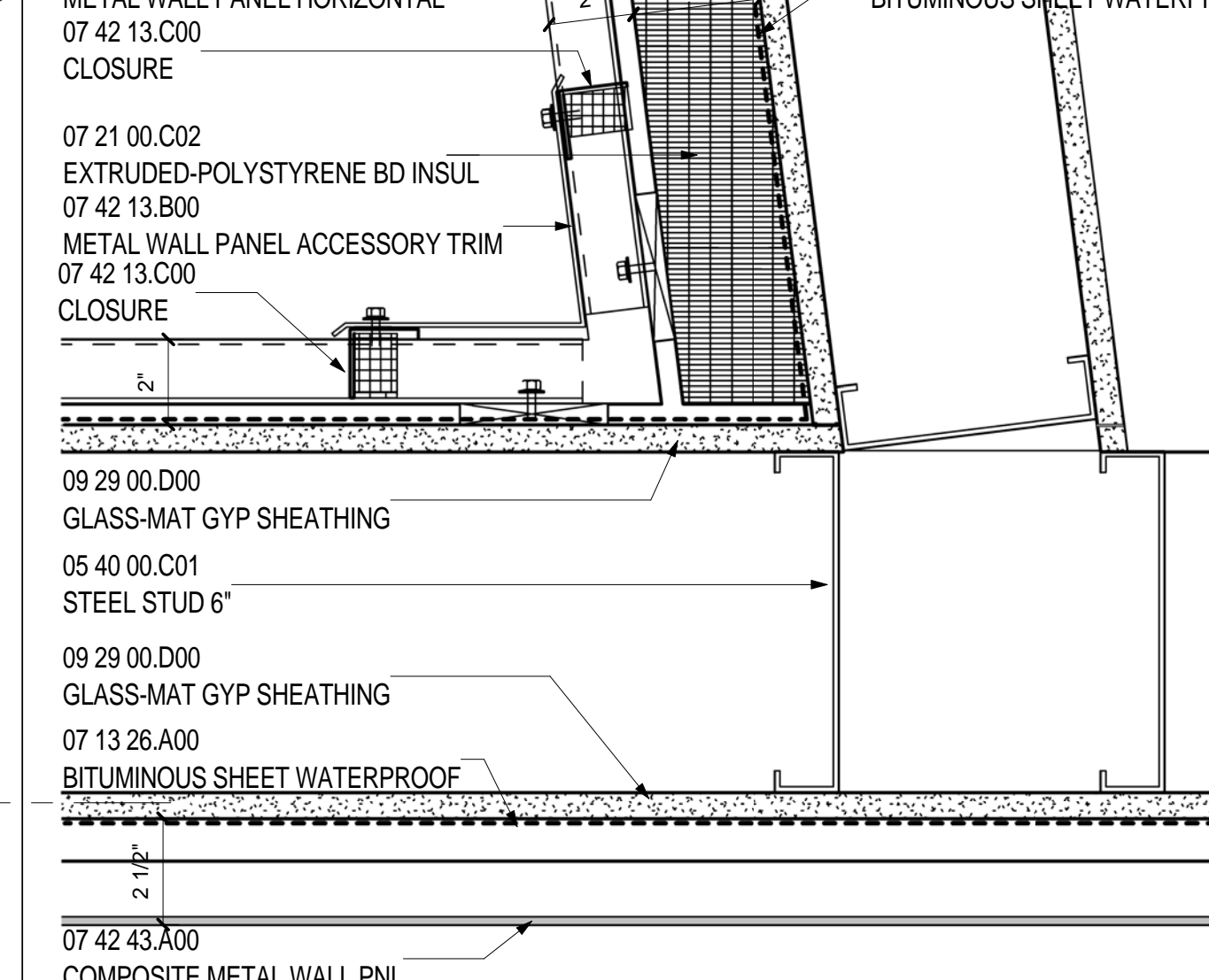

WALL TYPE A INSIDE MTL PNL CNR
SCALE: 3" = 1'-0" A09.35

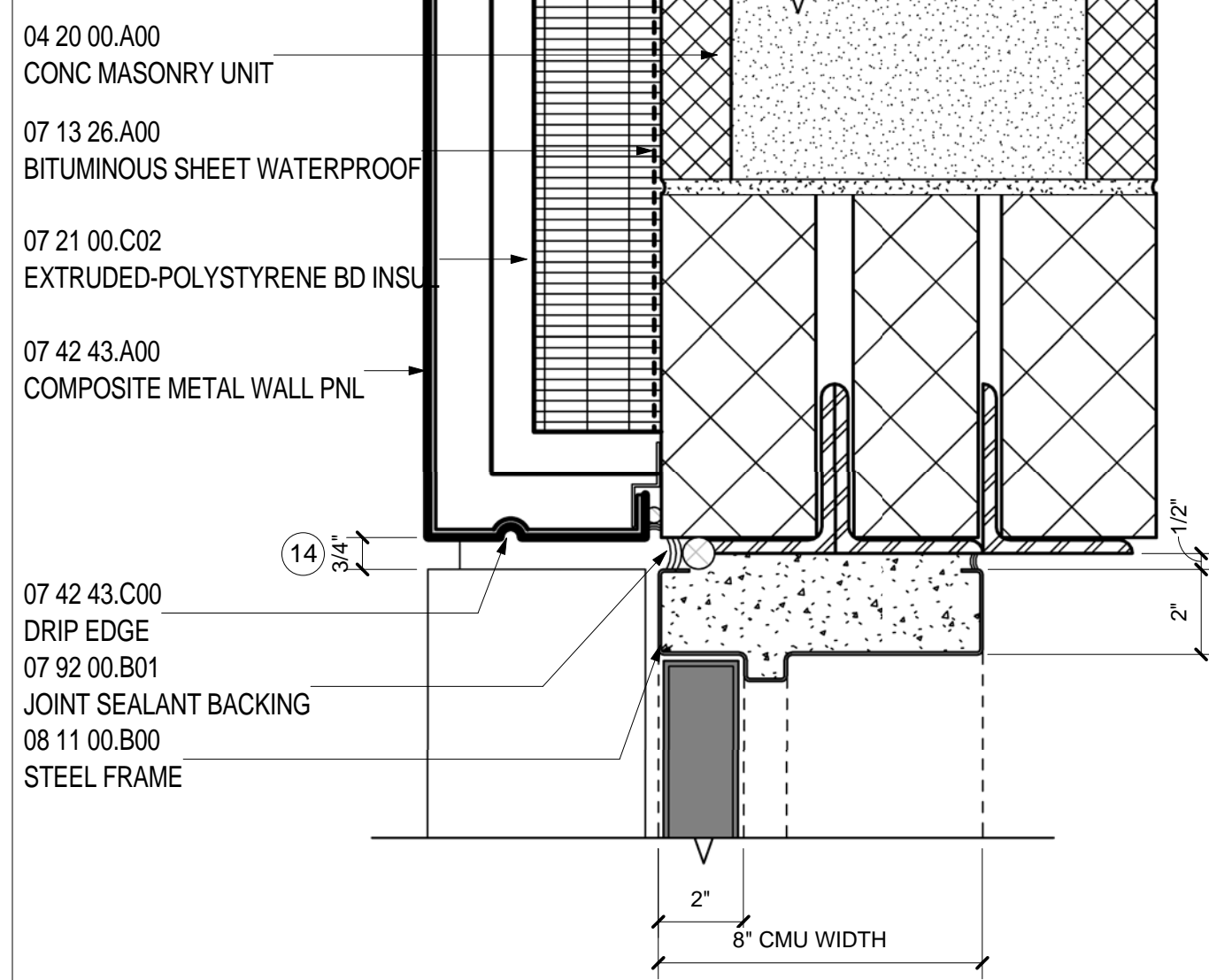

HEAD-DOOR TYPE A AT MTL PNL-CMU
SCALE: 3" = 1'-0" A09.23

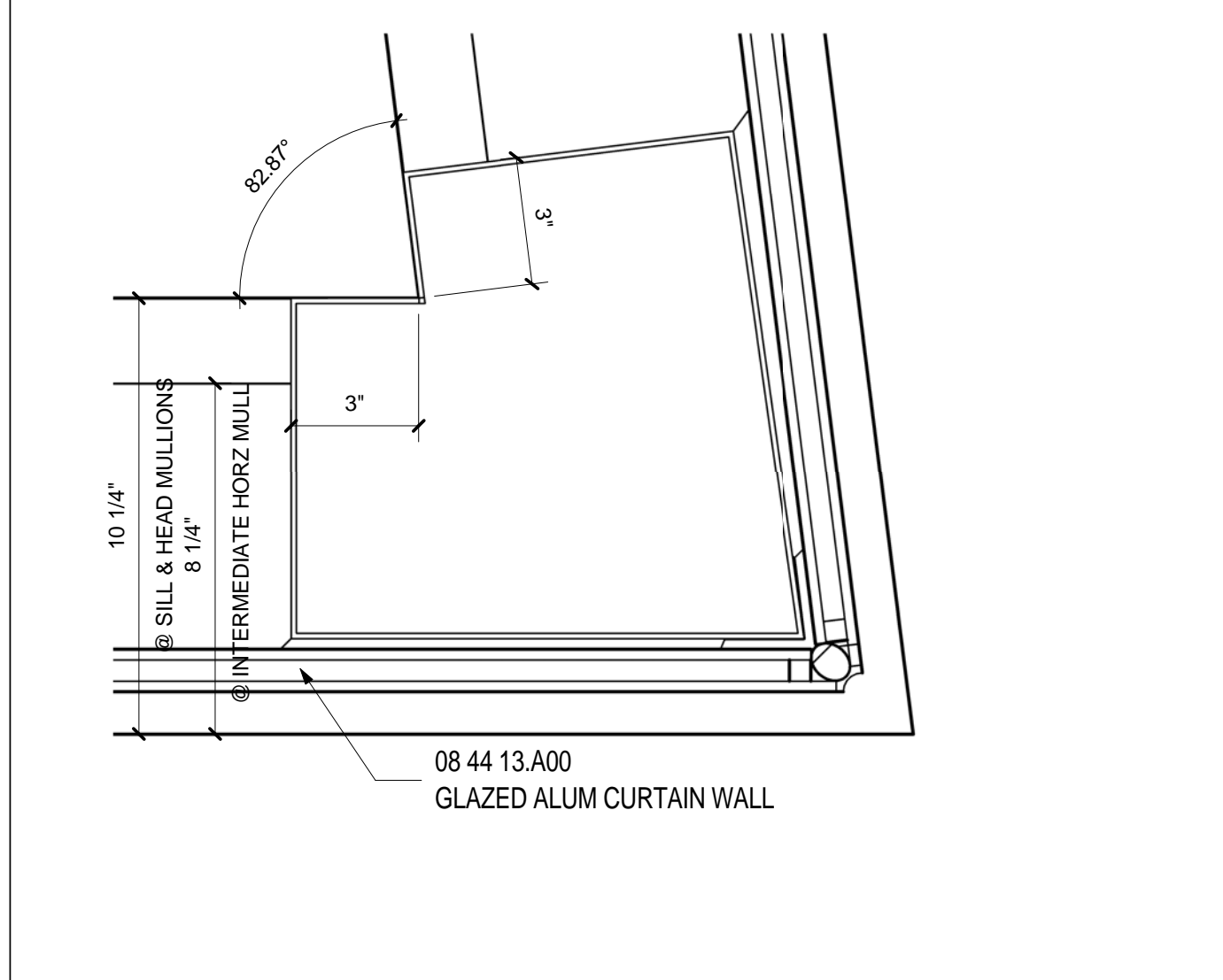

WALL TYPE B LVL 5 CORNER MULLION
SCALE: 3" = 1'-0" A09.33

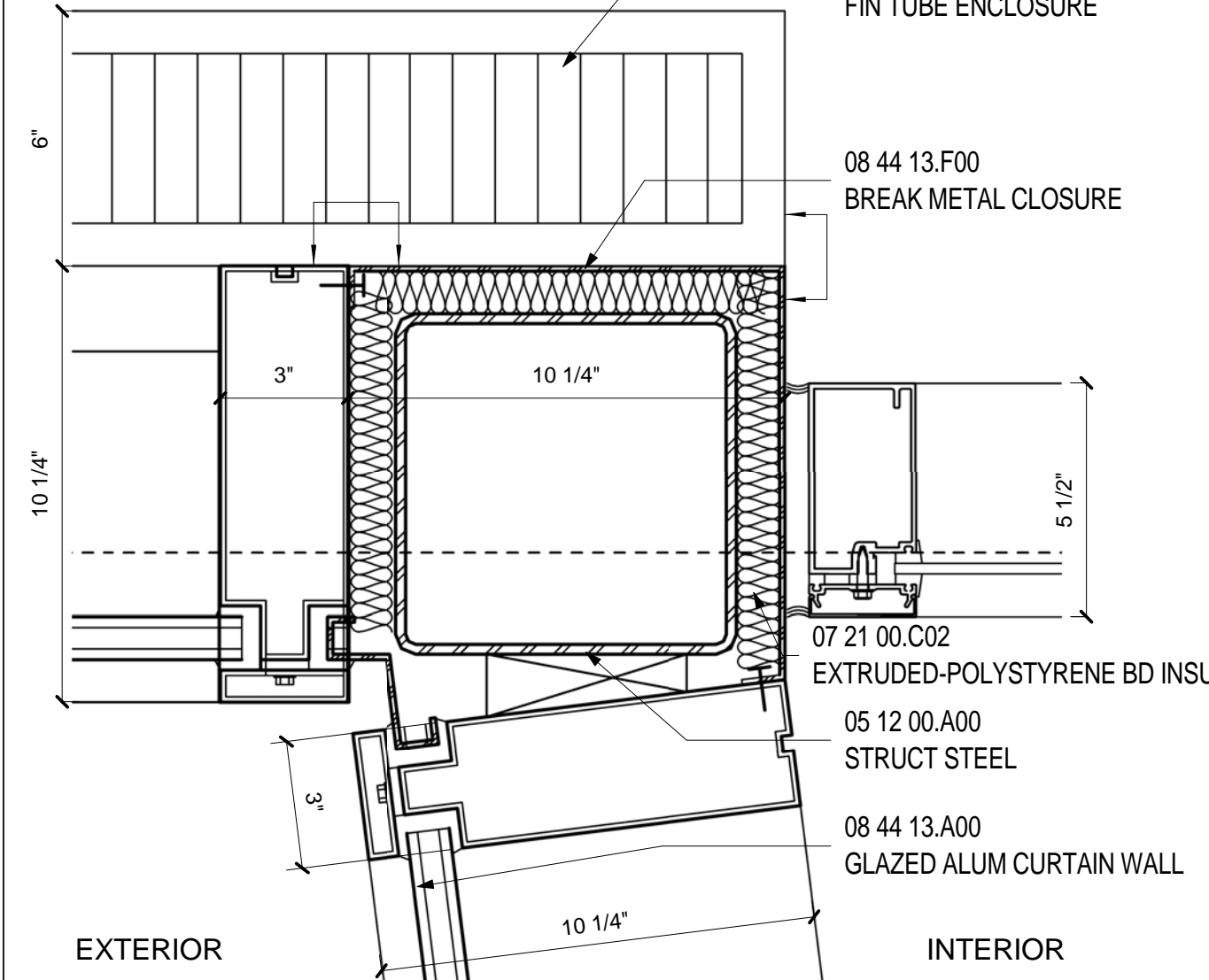

WALL TYPE B LVL 4 INSIDE CNR
SCALE: 3" = 1'-0" A09.34

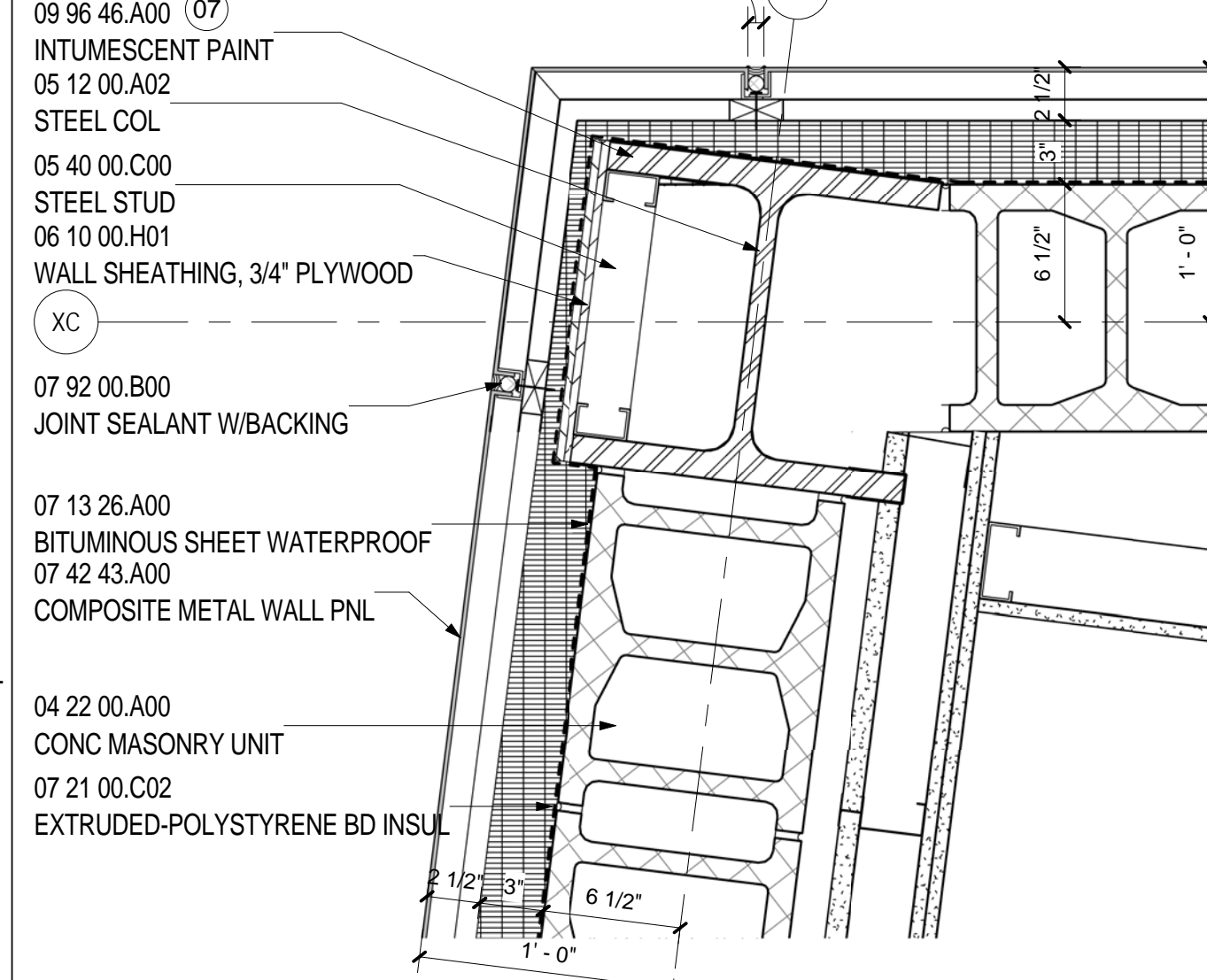

WALL TYPE A LVL 2 OUTSIDE CORNER
SCALE: 1 1/2" = 1'-0" A10.00

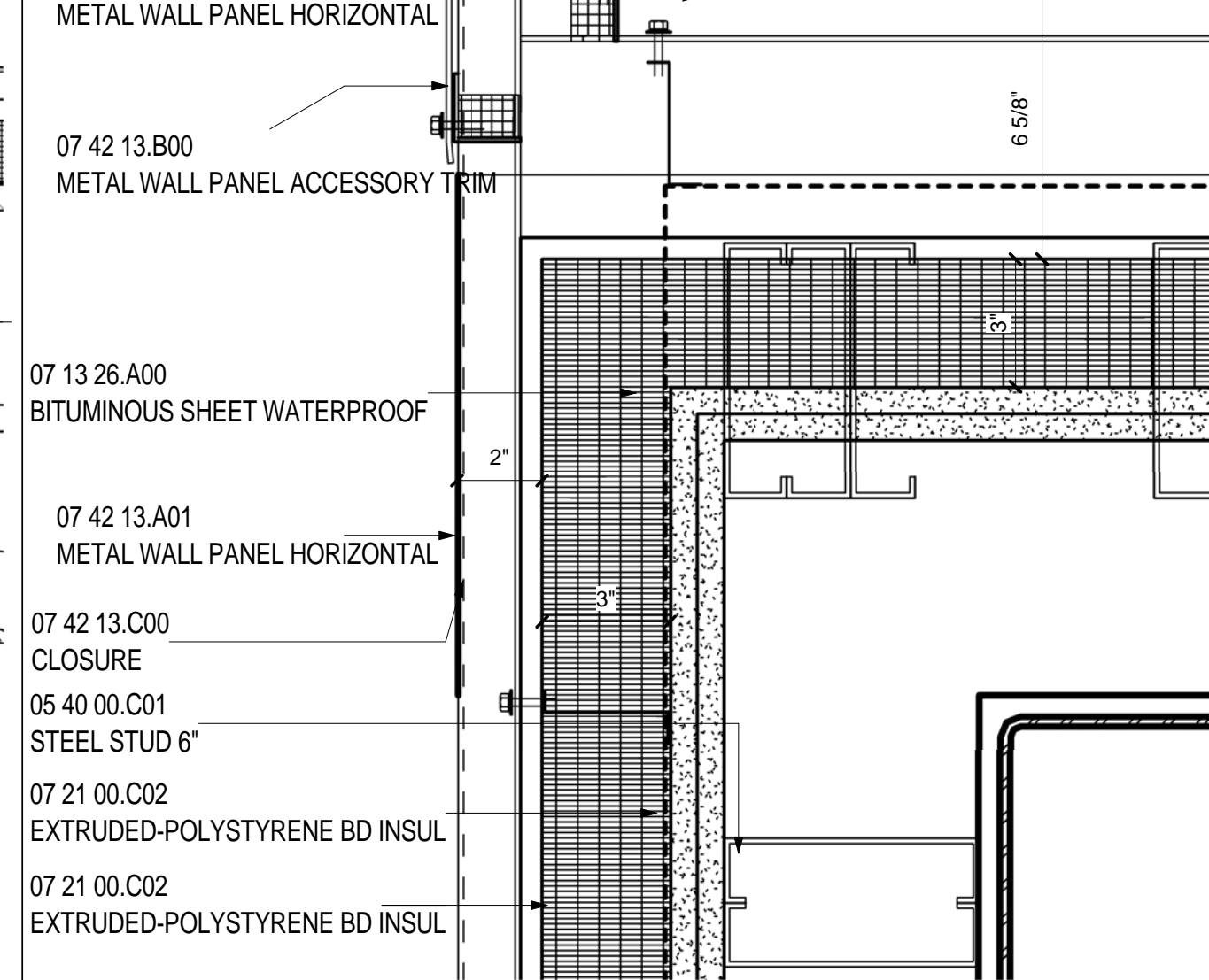

WALL TYPE A OUTSIDE MTL PNL CNR
SCALE: 3" = 1'-0" A10.01

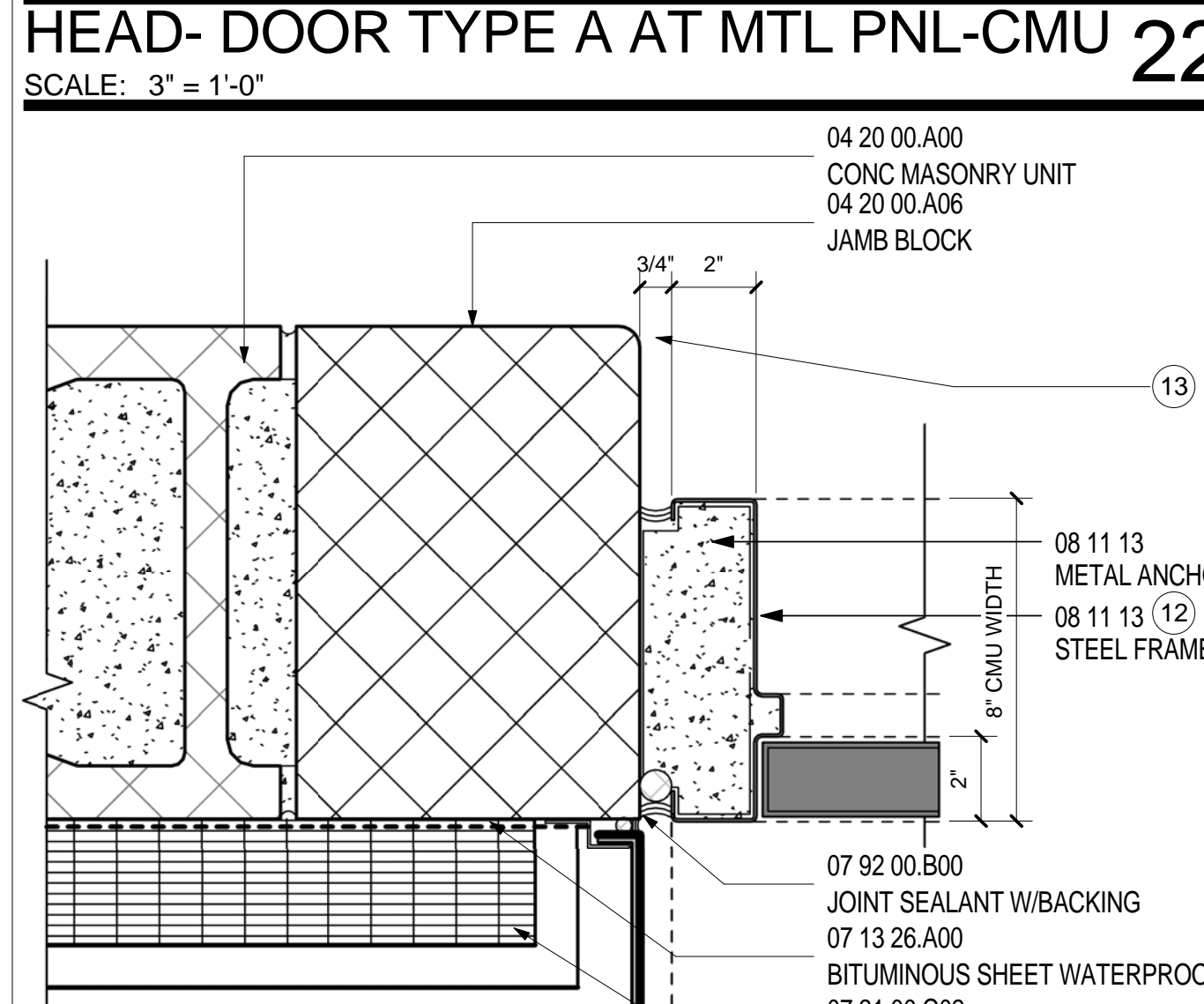

JAMB-DOOR TYPE A AT MTL PNL-CMU
SCALE: 3" = 1'-0" A09.23

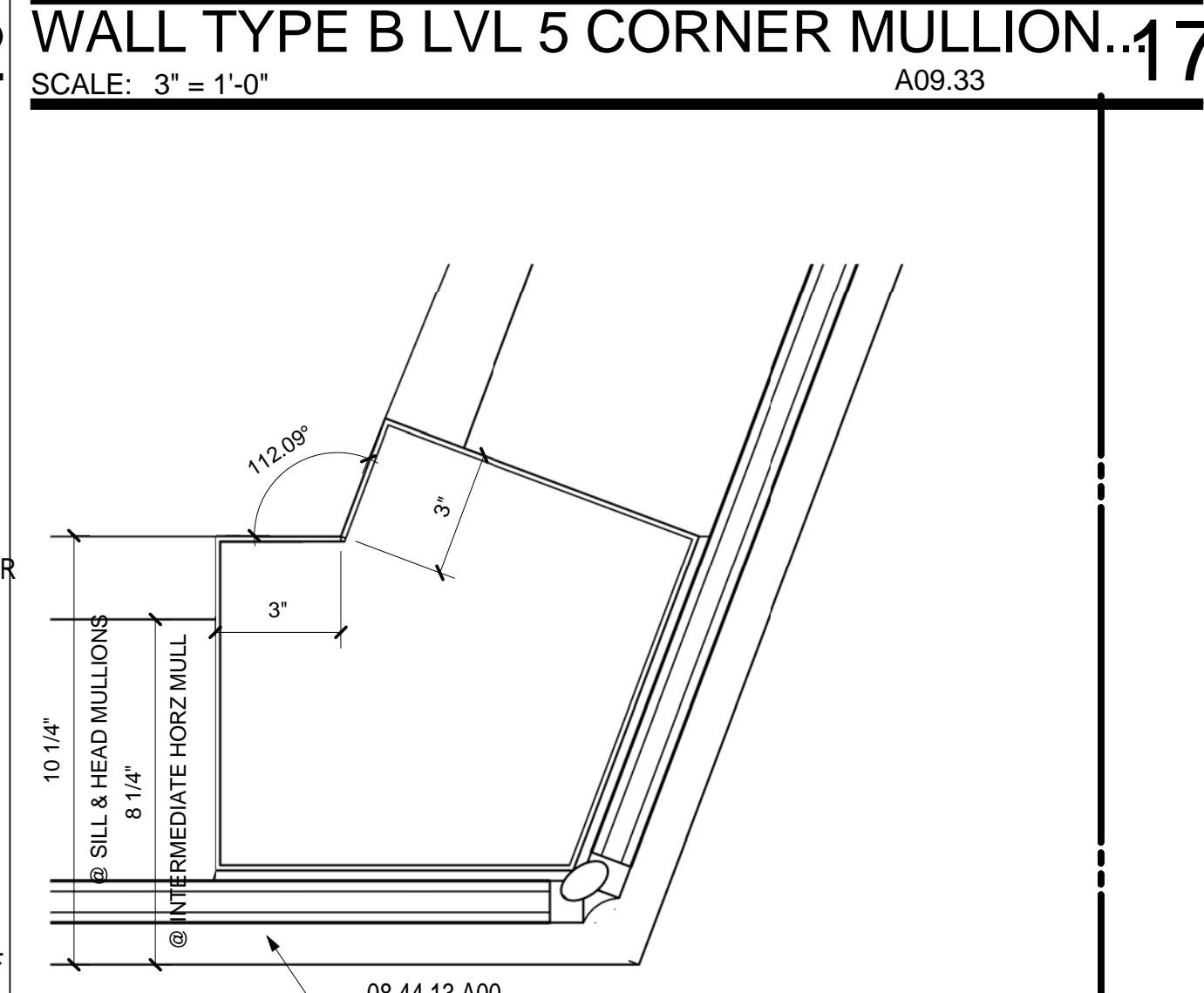

WALL TYPE B LVL 5 CORNER MULLION
SCALE: 3" = 1'-0" A09.32

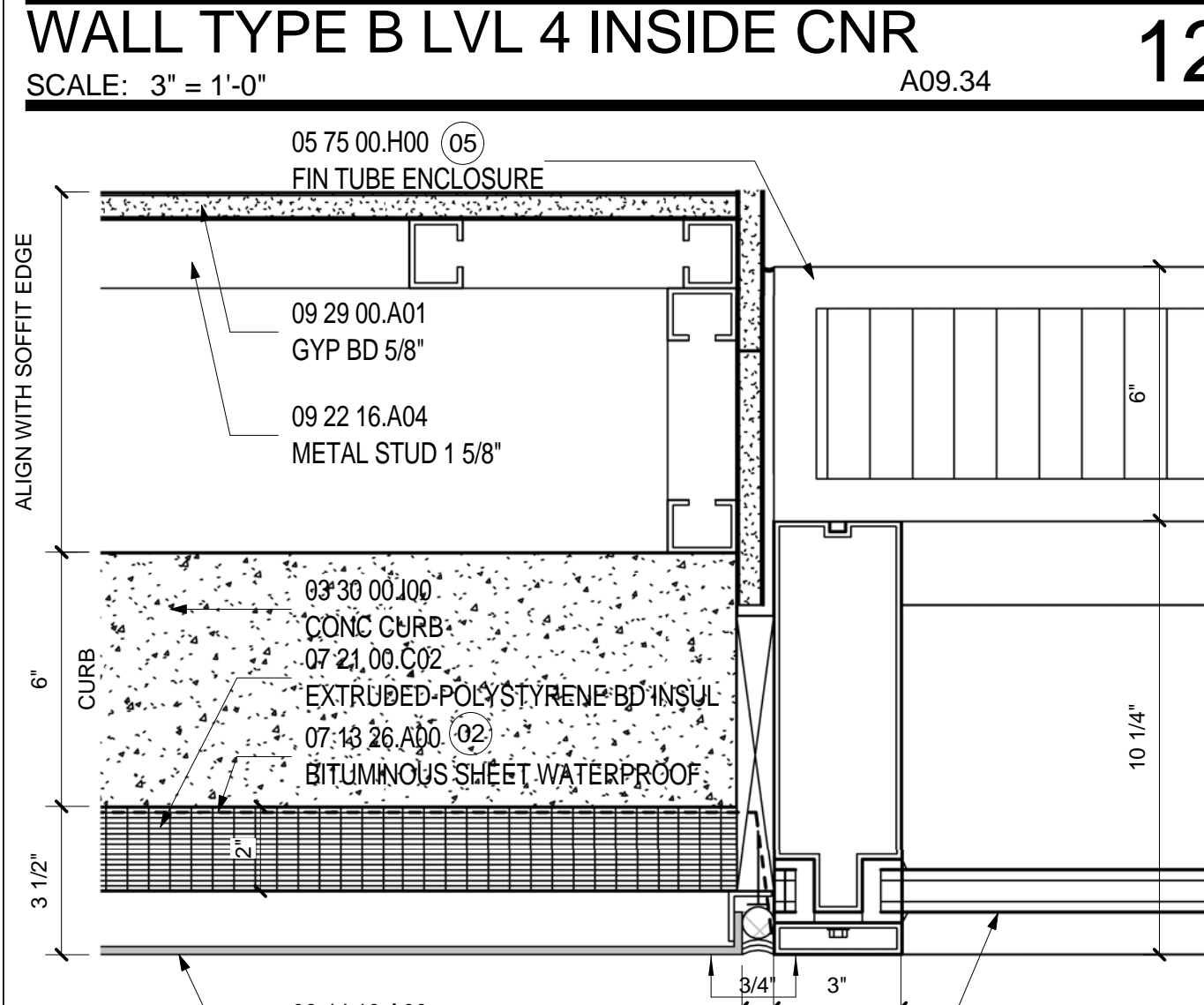

WALL TYPE B - LVL 4 CURB
SCALE: 3" = 1'-0" A09.30

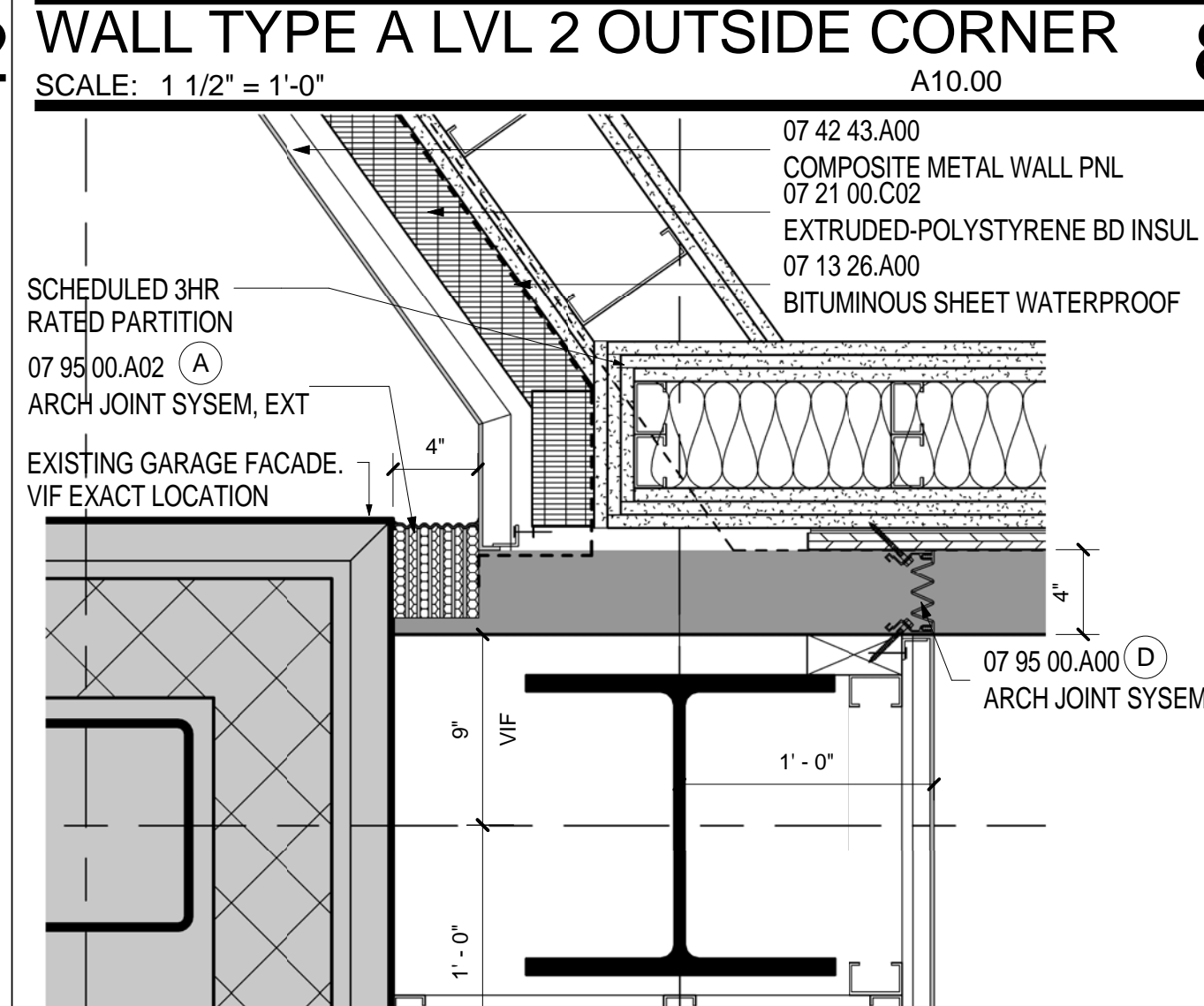

WALL TYPE A LVL 4 GARAGE LINK
SCALE: 1 1/2" = 1'-0" A09.23

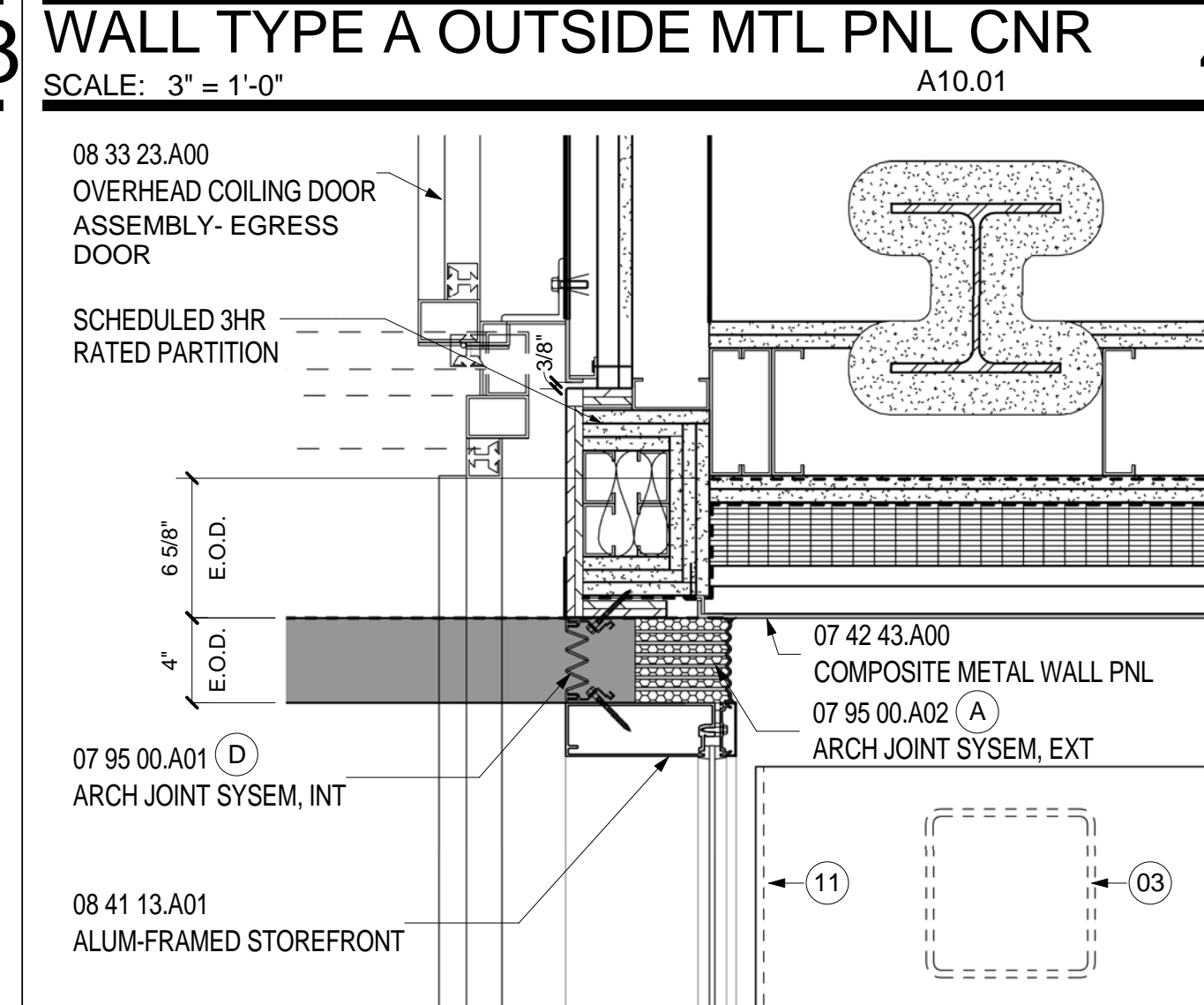

WALL TYPE A LVL 4 GARAGE LINK
SCALE: 1 1/2" = 1'-0" A09.23

SHEET NOTES

- RAIN LEADER WHERE OCCURS. REF: PLUMBING DRAWINGS FOR LOCATIONS.
- TAPE BITUMINOUS SHEET WATERPROOFING TO CURTAIN WALL FOR CONTINUOUS WATER/VAPOR/AIR BARRIER.
- NEW STEEL TUBE TO SUPPORT END OF EXISTING CUT STEEL TUBE BUMPER. FINISH TO MATCH STEEL BUMPER. RE: STRUCTURAL FOR MORE INFORMATION.
- CONTRACTION/CONSTRUCTION JOINT. RE: STRUCTURAL DRAWINGS FOR MORE INFORMATION.
- FIN TUBE ENCLOSURE. RE: MECHANICAL DRAWINGS FOR FIN TUBE INFORMATION.
- TAPE BITUMINOUS SHEET WATERPROOFING TO EXPANSION JOINT (BOTH SIDES) FOR CONTINUOUS WATER/VAPOR/AIR BARRIER.
- PROVIDE INTUMESCENT PAINT AT COLUMNS X025 AND X025 FROM LEVEL 2 TO UNDERSIDE OF LEVEL 4. PROVIDE SPRAY ON FIREPROOFING ABOVE LEVEL 4 AS REQUIRED.
- STOP INSULATION, GYPSUM SHEATHING AND WATERPROOFING AT TOP OF CURB FOR REMOVABLE PANELS.
- WRAP WATERPROOFING INTO FRAMED AREA OF REMOVABLE PANELS.
- REMOVABLE METAL PANELS FOR ACCESS TO CHILLERS.
- EXISTING STEEL TUBE AND RAIL CUT SHORT TO ACCOMMODATE NEW VESTIBULE. CAP ENDS OF STEEL TUBE AND HANDRAIL. FINISH TO MATCH.
- GROUT SOLID
- RADIAL CORNER
- ALIGN TOP OF DOOR TO BOTTOM OF REVEAL OF THE ADJACENT METAL PANEL
- EAST FACADE AT EGRESS STAIR TO BE 2HR RATED PER CODE DUE TO ADJACENCY TO GLAZING.
- COORDINATE DIMENSION WITH REVOLVING DOOR AND STEEL DOOR LOCATIONS. VIF.
- ALUMINUM DOOR CLADDED WITH METAL PANEL TO MATCH ADJACENT

Portland International Jetport
1001 Westbrook Street
Portland, Maine 04102

Gensler

2020 K Street, Northwest
Suite 200
Washington DC 20006
Telephone 202.721.5200
Facsimile 202.872.8587

Date	Description
12/03/08	75% CONSTRUCTION DOCUMENTS
01/23/09	95% CONSTRUCTION DOCUMENTS
10/26/09	ISSUED FOR PERMIT
7	11/12/09 ADDENDUM #2
145	09/01/11 ISSUED FOR CONSTRUCTION

Seal/Signature

Project Name
PJM Terminal Enhancement

Project Number
09.6395.000

Description
PLAN DETAILS

Scale
As indicated

A12.00

© 2009 Gensler