

City of Portland, Maine – Building or Use Permit Application 387 Congress Street, 04101, Tel: (207) 874-8703, FAX: 874-8716

Location of Construction: 110 Colonial Rd		Owner: DiBlasso, Phillip		Phone: 774-3293		Permit No: 980582	
Owner Address: SAA 04102		Lessee/Buyer's Name:		Phone:		BusinessName:	
Contractor Name:		Address:		Phone:		<div style="border: 2px solid black; padding: 5px; text-align: center;"> PERMIT ISSUED Permit Issued: JUN - 5 1998 CITY OF PORTLAND </div>	
Past Use: 1-fam		Proposed Use:		COST OF WORK: \$ 1,440.00 PERMIT FEE: \$ 25.00			
Proposed Project Description: Construct floating deck		Signature:		Signature:		Zoning Approval: Special Zone or Reviews: <input type="checkbox"/> Shoreland <input type="checkbox"/> Wetland <input type="checkbox"/> Flood Zone <input type="checkbox"/> Subdivision <input type="checkbox"/> Site Plan maj <input type="checkbox"/> minor <input type="checkbox"/> mm <input type="checkbox"/>	
Permit Taken By: Mary Gresik		Date Applied For: 27 May 1998		PEDESTRIAN ACTIVITIES DISTRICT (P.A.D.) Action: Approved <input type="checkbox"/> Approved with Conditions: <input type="checkbox"/> Denied <input type="checkbox"/> Signature: Date:		Zoning Appeal <input type="checkbox"/> Variance <input type="checkbox"/> Miscellaneous <input type="checkbox"/> Conditional Use <input type="checkbox"/> Interpretation <input type="checkbox"/> Approved <input type="checkbox"/> Denied	

1. This permit application does not preclude the Applicant(s) from meeting applicable State and Federal rules.
2. Building permits do not include plumbing, septic or electrical work.
3. Building permits are void if work is not started within six (6) months of the date of issuance. False information may invalidate a building permit and stop all work..

**PERMIT ISSUED
WITH REQUIREMENTS**

CERTIFICATION

I hereby certify that I am the owner of record of the named property, or that the proposed work is authorized by the owner of record and that I have been authorized by the owner to make this application as his authorized agent and I agree to conform to all applicable laws of this jurisdiction. In addition, if a permit for work described in the application is issued, I certify that the code official's authorized representative shall have the authority to enter all areas covered by such permit at any reasonable hour to enforce the provisions of the code(s) applicable to such permit

28 May 1998

SIGNATURE OF APPLICANT ADDRESS: DATE: PHONE:

RESPONSIBLE PERSON IN CHARGE OF WORK, TITLE PHONE:

White-Permit Desk Green-Assessor's Canary-D.P.W. Pink-Public File Ivory Card-Inspector

CEO DISTRICT



COMMENTS

6/14/98 - Left message for owner on machine ^{Tax.}

04/08/00 - no one at home - could see deck from side of road - appears to be complete and no obvious problems evident. ^{Ins}
Close out

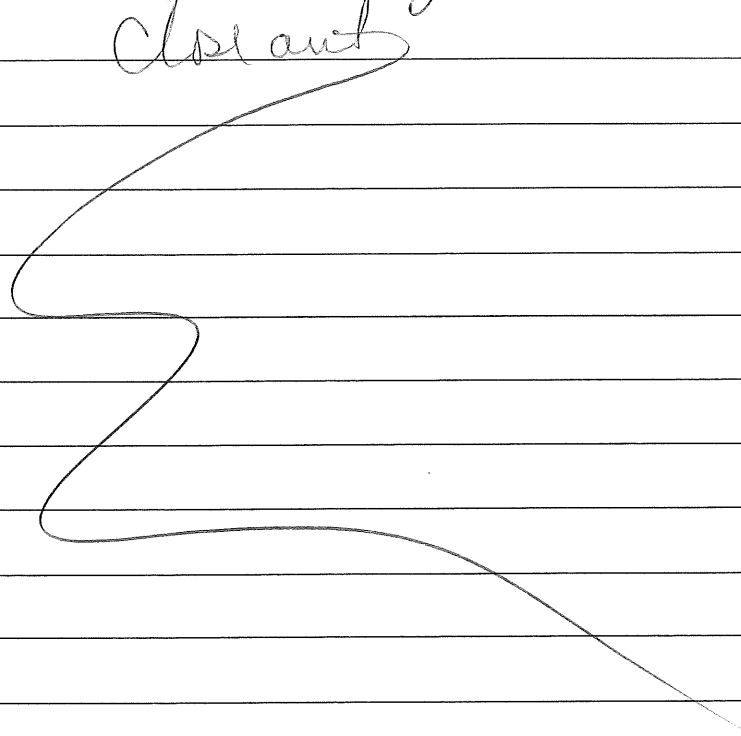

Inspection Record

Type	Date
Foundation: _____	_____
Framing: _____	_____
Plumbing: _____	_____
Final: _____	_____
Other: _____	_____

BUILDING PERMIT REPORT

DATE: 3 June 98 ADDRESS: 110 Colonial Rd (192-K-071)
 REASON FOR PERMIT: To Construct detached deck
 BUILDING OWNER: Di Biase, P.
 CONTRACTOR: SAA
 PERMIT APPLICANT: ↑
 USE GROUP U BOCA 1996 CONSTRUCTION TYPE 5B

CONDITION(S) OF APPROVAL

This Permit is being issued with the understanding that the following conditions are met:

Approved with the following conditions: *1, *2, *8, *10, *20

1. This permit does not excuse the applicant from meeting applicable State and Federal rules and laws.
2. Before concrete for foundation is placed, approval from the Development Review Coordinator and Inspection Services must be obtained. (A 24 hour notice is required prior to inspection)
3. Precaution must be taken to protect concrete from freezing.
4. It is strongly recommended that a registered land surveyor check all foundation forms before concrete is placed. This is done to verify that the proper setbacks are maintained.
5. Private garages located beneath habitable rooms in occupancies in Use Group R-1, R-2, R-3 or I-1 shall be separated from adjacent interior spaces by fire partitions and floor/ceiling assembly which are constructed with not less than 1-hour fire resisting rating. Private garages attached side-by-side to rooms in the above occupancies shall be completely separated from the interior spaces and the attic area by means of ½ inch gypsum board or the equivalent applied to the garage means of ½ inch gypsum board or the equivalent applied to the garage side. (Chapter 4 Section 407.0 of the BOCA/1996)
6. All chimneys and vents shall be installed and maintained as per Chapter 12 of the City's Mechanical Code. (The BOCA National Mechanical Code/1993).
7. Sound transmission control in residential building shall be done in accordance with Chapter 12 section 1214.0 of the city's building code.
8. Guardrails & Handrails: A guardrail system is a system of building components located near the open sides of elevated walking surfaces for the purpose of minimizing the possibility of an accidental fall from the walking surface to the lower level. Minimum height all Use Groups 42", except Use Group R which is 36". In occupancies in Use Group A, B, H-4, I-1, I-2 M and R and public garages and open parking structures, open guards shall have balusters or be of solid material such that a sphere with a diameter of 4" cannot pass through any opening. Guards shall not have an ornamental pattern that would provide a ladder effect. (Handrails shall be a minimum of 34" but not more than 38". Use Group R-3 shall not be less than 30", but not more than 38".) Handrail grip size shall have a circular cross section with an outside diameter of at least 1 1/4" and not greater than 2".
9. Headroom in habitable space is a minimum of 7'6".
10. Stair construction in Use Group R-3 & R-4 is a minimum of 10" tread and 7 3/4" maximum rise. All other Use group minimum 11" tread. 7" maximum rise.
11. The minimum headroom in all parts of a stairway shall not be less than 80 inches. (6' 8")
12. Every sleeping room below the fourth story in buildings of use Groups R and I-1 shall have at least one operable window or exterior door approved for emergency egress or rescue. The units must be operable from the inside without the use of special knowledge or separate tools. Where windows are provided as means of egress or rescue they shall have a sill height not more than 44 inches (1118mm) above the floor. All egress or rescue windows from sleeping rooms shall have a minimum net clear opening height dimension of 24 inches (610mm). The minimum net clear opening width dimension shall be 20 inches (508mm), and a minimum net clear opening of 5.7 sq. ft.
13. Each apartment shall have access to two (2) separate, remote and approved means of egress. A single exit is acceptable when it exits directly from the apartment to the building exterior with no communications to other apartment units.
14. All vertical openings shall be enclosed with construction having a fire rating of at least one (1) hour, including fire doors with self closer's. (Over 3 stories in height requirements for fire rating is two (2) hours.)
15. The boiler shall be protected by enclosing with (1) hour fire-rated construction including fire doors and ceiling, or by providing automatic extinguishment.
16. All single and multiple station smoke detectors shall be of an approved type and shall be installed in accordance with the

provisions of the City's Building Code Chapter 9, Section 19, 920.3.2 (BOCA National Building Code/1996), and NFPA 101 Chapter 18 & 19. (Smoke detectors shall be installed and maintained at the following locations):

- In the immediate vicinity of bedrooms
- In all bedrooms
- In each story within a dwelling unit, including basements

In addition to the required AC primary power source, required smoke detectors in occupancies in Use Groups R-2, R-3 and I-1 shall receive power from a battery when the AC primary power source is interrupted. (Interconnection is required)

17. A portable fire extinguisher shall be located as per NFPA #10. They shall bear the label of an approved agency and be of an approved type.
18. The Fire Alarm System shall be maintained to NFPA #72 Standard.
19. The Sprinkler System shall maintained to NFPA #13 Standard.
20. All exit signs, lights, and means of egress lighting shall be done in accordance with Chapter 10 Section & Subsections 1023. & 1024. Of the City's building code. (The BOCA National Building Code/1996)
21. Section 25-135 of the Municipal Code for the City of Portland states, "No person or utility shall be granted a permit to excavate or open any street or sidewalk from the time of November 15 of each year to April 15 of the following year".
22. The builder of a facility to which Section 4594-C of the Maine State Human Rights Act Title 5 MRSA refers, shall obtain a certification from a design professional that the plans commencing construction of the facility, the builder shall submit the certification to the Division of Inspection Services.
23. Ventilation shall meet the requirements of Chapter 12 Sections 1210. Of the City's Building Code.
24. All electrical, plumbing and HVAC permits must be obtained by a Master Licensed holders of their trade.
25. All requirements must be met before a final Certificate of Occupancy is issued.
26. All building elements shall meet the fastening schedule as per Table 2305.2 of the City's Building Code. (The BOCA National Building Code/1996).
27. Ventilation of spaces within a building shall be done in accordance with the City's Mechanical Code (The BOCA National Mechanical Code/1993).
28. Please read and implement the attached Land Use-Zoning report requirements.

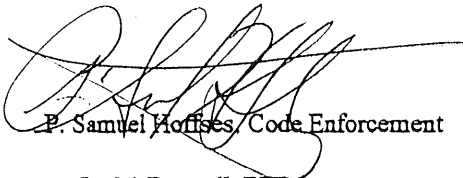

P. Samuel Hoffies, Code Enforcement

cc: Lt McDougall, PFD
Marge Schmuckal

THIS IS NOT A PERMIT/CONSTRUCTION CANNOT COMMENCE UNTIL THE PERMIT IS ISSUED

**Building or Use Permit Pre-Application
Additions/Alterations/Accessory Structures
To Detached Single Family Dwelling**

In the interest of processing your application in the quickest possible manner, please complete the Information below for a Building or Use Permit.

NOTEIf you or the property owner owes real estate or personal property taxes or user charges on any property within the City, payment arrangements must be made before permits of any kind are accepted.**

Location/Address of Construction: 110 Colonial Rd

Tax Assessor's Chart, Block & Lot Number Chart# <u>192</u> Block# <u>K</u> Lot# <u>71</u>		Owner: <u>S. Philip D. B. ASA</u>	Telephone#: <u>774-3293</u>
Owner's Address: <u>110 Colonial Rd</u> <u>PTH 04102</u>		Lessee/Buyer's Name (If Applicable) _____	Cost Of Work: <u>CO</u> Fee <u>\$ 1440</u> <u>\$ 25</u>
Proposed Project Description:(Please be as specific as possible) <u>Construct a floating deck 12x12 along rear of house w/ 2 '10' x 6'8" exterior door</u>			
Contractor's Name, Address & Telephone <u>Phil D. B. ASA 110 Colonial Rd, Bethel, ME 04102</u>		Rec'd By: <u>M.A.</u>	

See attached paperwork

Separate permits are required for Internal & External Plumbing, HVAC and Electrical installation.

- All construction must be conducted in compliance with the 1996 B.O.C.A. Building Code as amended by Section 6-Art II.
- All plumbing must be conducted in compliance with the State of Maine Plumbing Code.
- All Electrical Installation must comply with the 1996 National Electrical Code as amended by Section 6-Art III.
- HVAC(Heating, Ventilation and Air Conditioning) installation must comply with the 1993 BOCA Mechanical Code.

You must Include the following with you application:

- 1) A Copy of Your Deed or Purchase and Sale Agreement
- 2) A Copy of your Construction Contract, if available
- 3) A Plot Plan (Sample Attached)

If there is expansion to the structure, a complete plot plan (Site Plan) must include:

- The shape and dimension of the lot, all existing buildings (if any), the proposed structure and the distance from the actual property lines. Structures include decks porches, a bow windows cantilever sections and roof overhangs, as well as, sheds, pools, garages and any other accessory structures.
- Scale and required zoning district setbacks

4) Building Plans (Sample Attached)

A complete set of construction drawings showing all of the following elements of construction:

- Cross Sections w/Framing details (including porches, decks w/ railings, and accessory structures)
- Floor Plans & Elevations
- Window and door schedules
- Foundation plans with required drainage and dampproofing
- Electrical and plumbing layout. Mechanical drawings for any specialized equipment such as furnaces, chimneys, gas equipment, HVAC equipment (air handling) or other types of work that may require special review must be included.

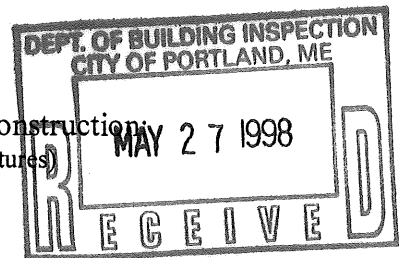

Certification

I hereby certify that I am the Owner of record of the named property, or that the proposed work is authorized by the owner of record and that I have been authorized by the owner to make this application as his/her authorized agent. I agree to conform to all applicable laws of this jurisdiction. In addition, if a permit for work described in this application is issued, I certify that the Code Official's authorized representative shall have the authority to enter all areas covered by this permit at any reasonable hour to enforce the provisions of the codes applicable to this permit.

Signature of applicant: [Signature] Date: 5/27/98

Site Review Fee: \$150.00/Building Permit Fee: \$25.00 for the 1st \$1000.cost plus \$5.00 per \$1,000.00 construction cost thereafter.

Applicant: Philip DiBiasse
Address: 110 Colonial Rd

Date: 6/2/98
C-B-L: 192-K-71

CHECK-LIST AGAINST ZONING ORDINANCE

Date - Existing

Zone Location - R-3

Interior or corner lot -

Proposed Use/Work - construct floating Deck - 12' x 12'

Sewage Disposal -

Lot Street Frontage -

Front Yard - N/A

Rear Yard - 25' req - 50' shown

Side Yard - 8' req - 15' shown

Projections -

Width of Lot -

Height -

Lot Area - 9,340^{sq}

Lot Coverage/ Impervious Surface -

Area per Family -

Off-street Parking -

Loading Bays -

Site Plan - N/A

Shoreland Zoning/ Stream Protection - N/A

Flood Plains - N/A

McLaughlin

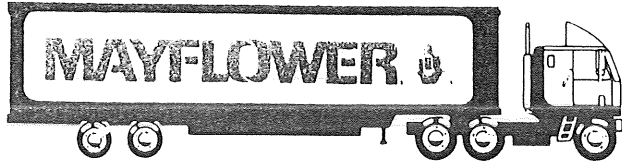

EMPLOYEE AND EXECUTIVE MOVES
OFFICE AND PLANT RELOCATIONS
ELECTRONICS AND HIGH VALUE EQUIP.
EXHIBITS & DISPLAYS

COMPLETE HOUSEHOLD MOVING AND STORAGE SERVICES

★★★★ SINCE 1936 ★★★★★

McLaughlin Transportation Systems, Inc.

8 NEW ENGLAND LOCATIONS
12 Washington Avenue • Scarborough, ME 04074

805.87

Framing &

- 18 @ 2x8x12
- 1 @ 2x4x8
- 4 @ 4x4x8
- 26 @ 5/4 x 14

Railings

- 4 @ 2x4x12
- 2 @ 2x4x10
- 2 @ 2x6x12
- 1 @ 2x6x10
- 7 @ 2x2x36 Balusters

Stairs

- 2 @ 2x4x8
- 1 @ 2x6x8
- 1 @ 2x10x12
- 1 @ 2x10x10

Misc.

- 6 @ 5/8 Lags
- ~~6 @ 1/2 Lags & Washers~~
- ~~10 @ 1/2 Lags~~

- 11 @ 2x8 Joist Hangers
- Cement blocks

~~10 @ 1/2 Lags~~

207-772-8300
800-427-2941
FAX 207-883-5792

CROSSMATS

EVERYTHING TO BUILD WITH

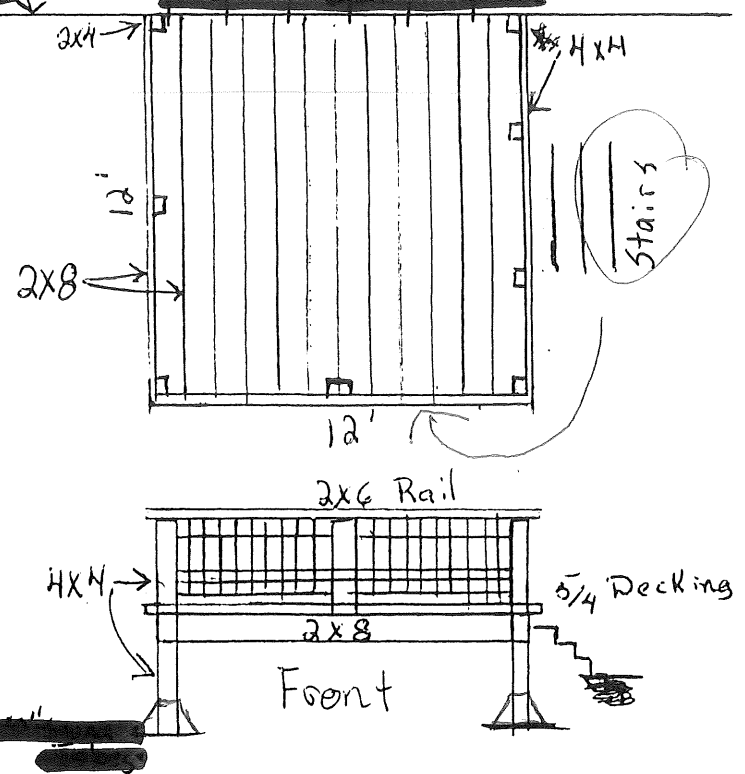

Floating deck not-attached to house. Sit on concrete block.

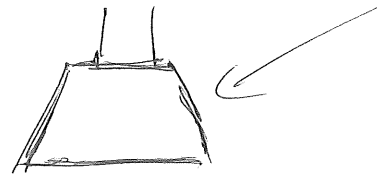

COVER

BUILDING ON SUCCESS...TOGETHER

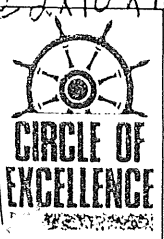

AWARD WINNING AGENT

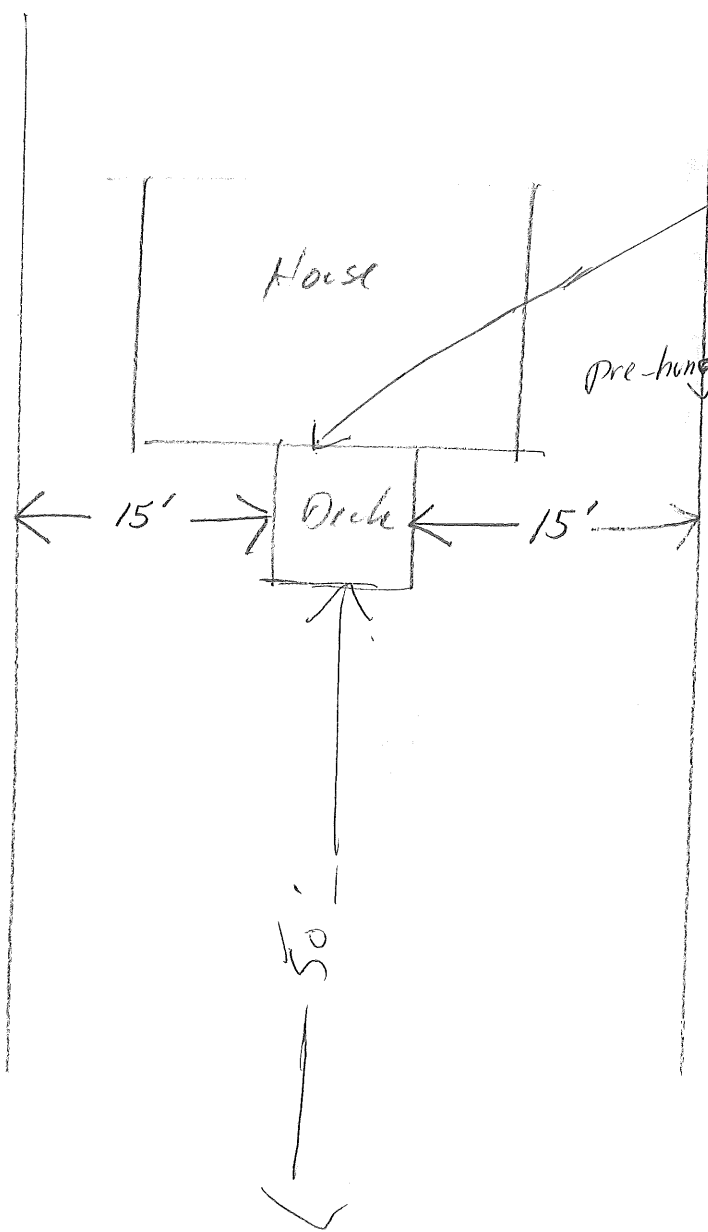

House

Deck

50'

15'

15'

3x5 window will be expanded to a 2'10" x 6'8" pre-hung exterior door w/ double 2x4 headers.