



HARRIMAN

AUBURN PORTLAND MANCHESTER

JEWISH COMMUNITY ALLIANCE OF SOUTHERN MAINE

PORTLAND, ME

Harriman Project No. 15309

Key Plan Proj North

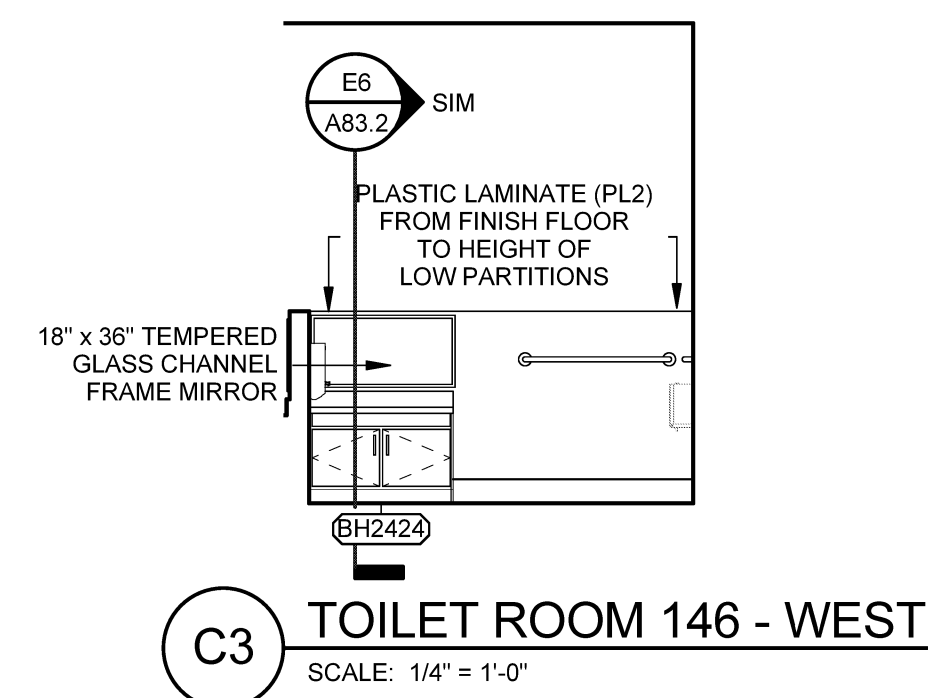
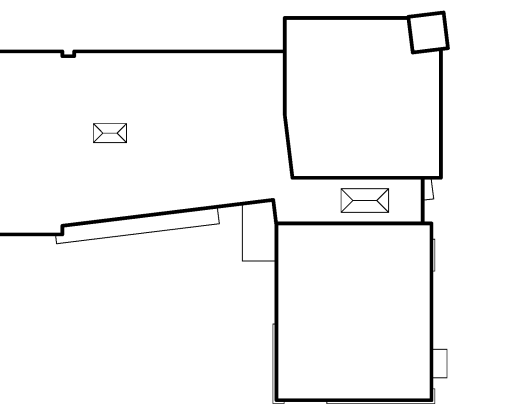

C3 TOILET ROOM 146 - WEST SCALE: 1/4" = 1'-0"

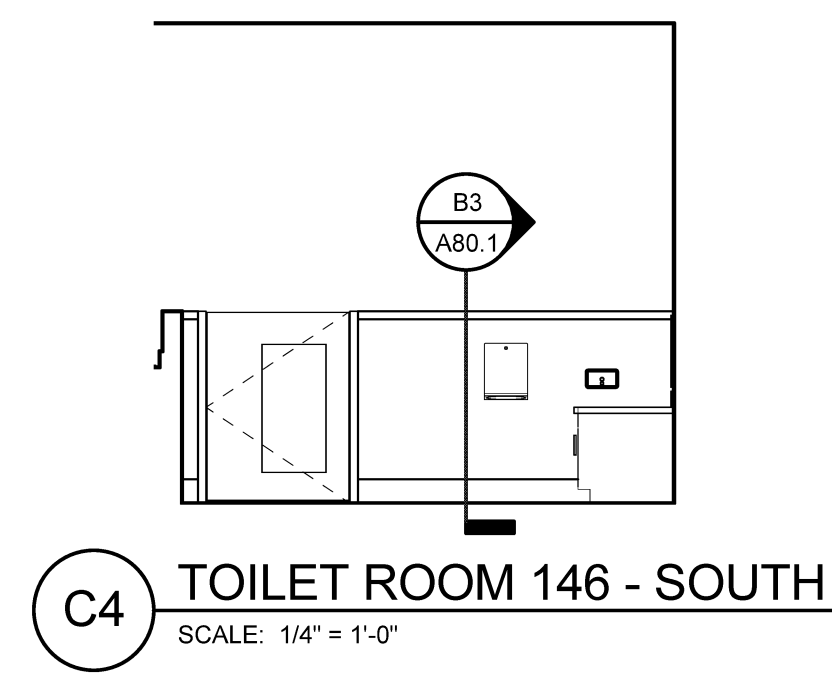

C4 TOILET ROOM 146 - SOUTH SCALE: 1/4" = 1'-0"

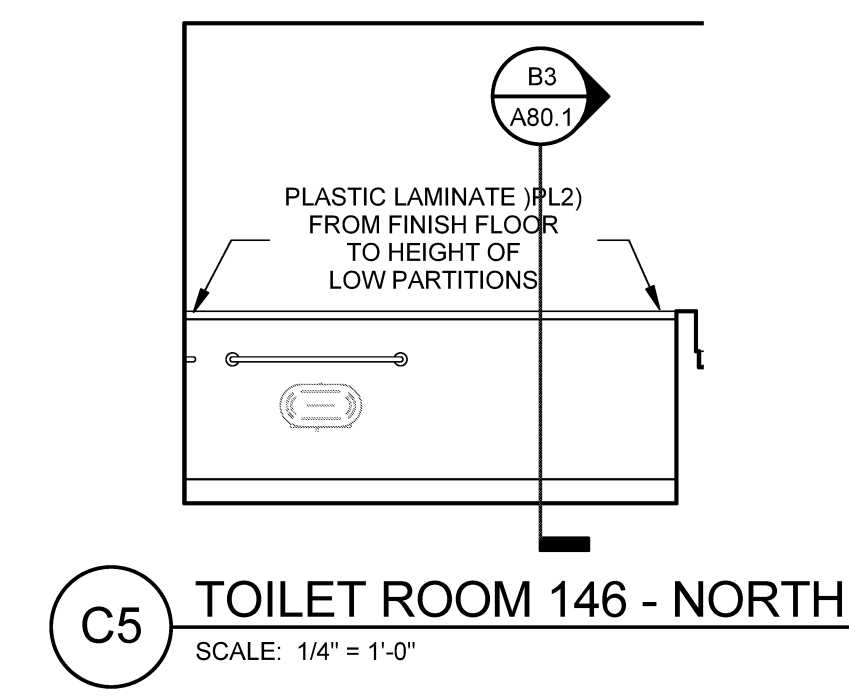

C5 TOILET ROOM 146 - NORTH SCALE: 1/4" = 1'-0"

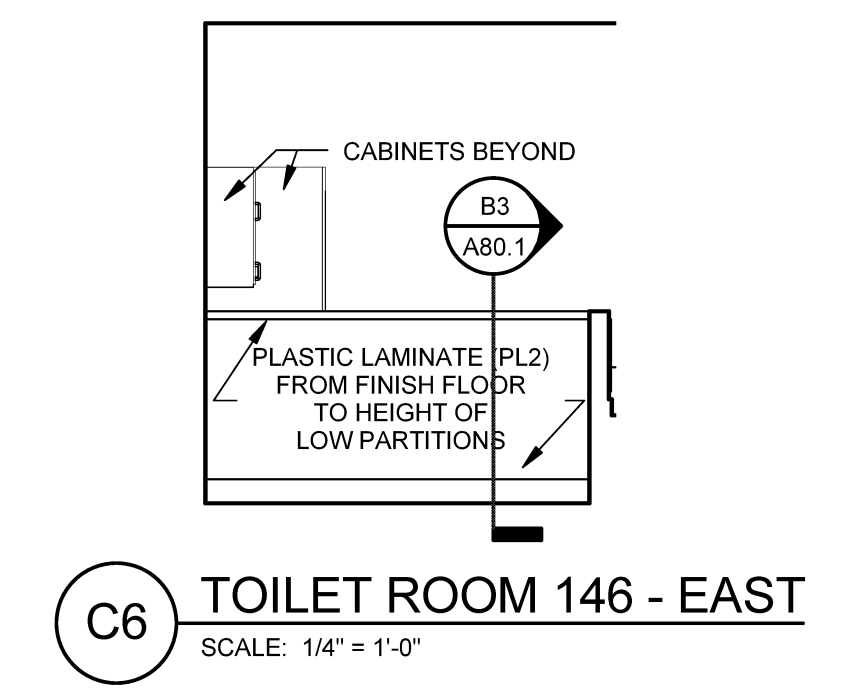

C6 TOILET ROOM 146 - EAST SCALE: 1/4" = 1'-0"

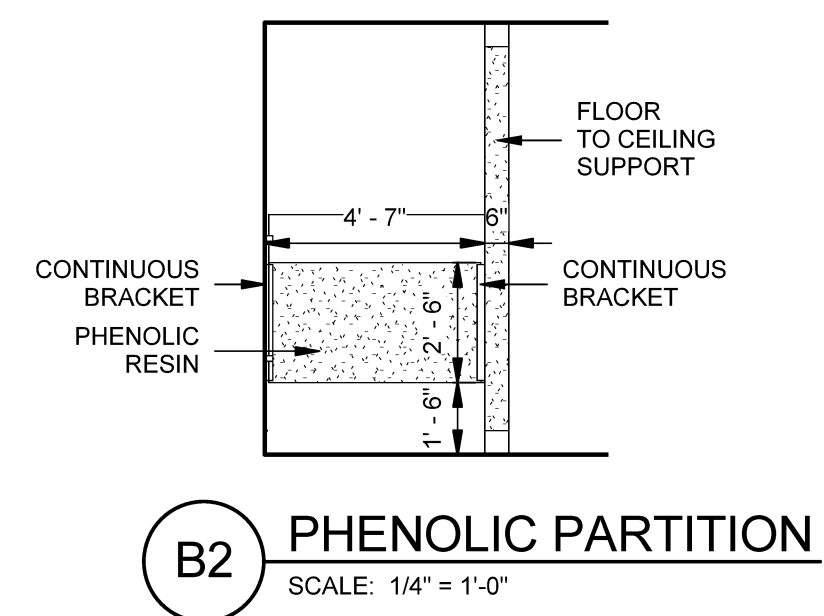

B2 PHENOLIC PARTITION SCALE: 1/4" = 1'-0"



B3 TOILET ROOM 142 - WEST SCALE: 1/4" = 1'-0"

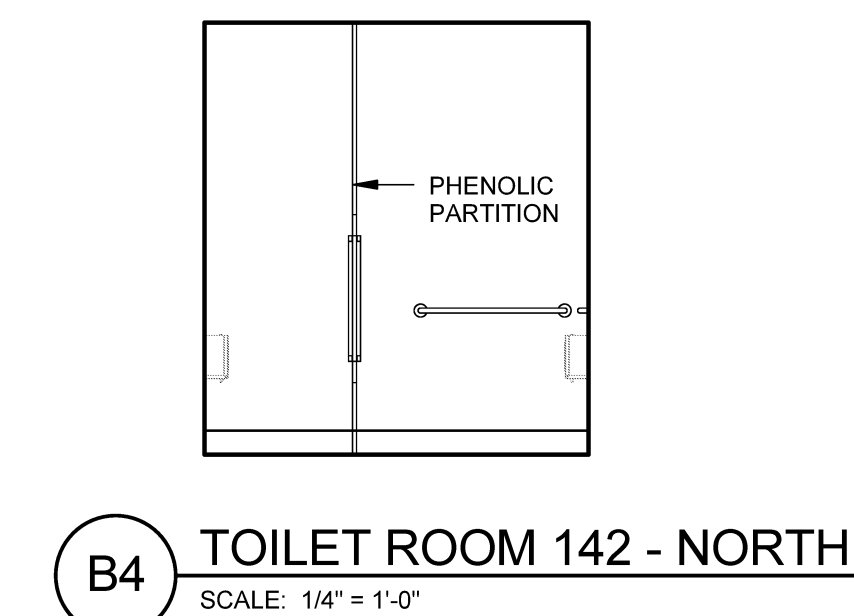

B4 TOILET ROOM 142 - NORTH SCALE: 1/4" = 1'-0"

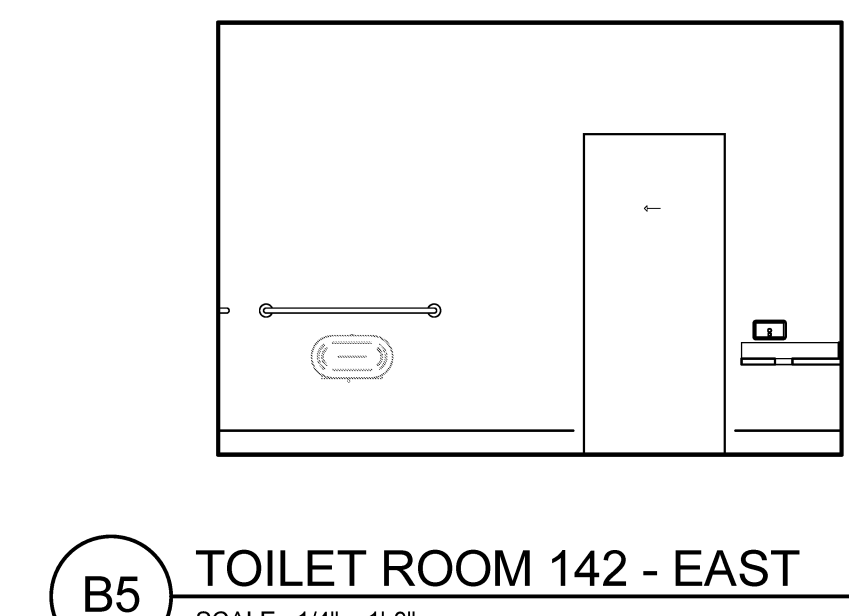

B5 TOILET ROOM 142 - EAST SCALE: 1/4" = 1'-0"

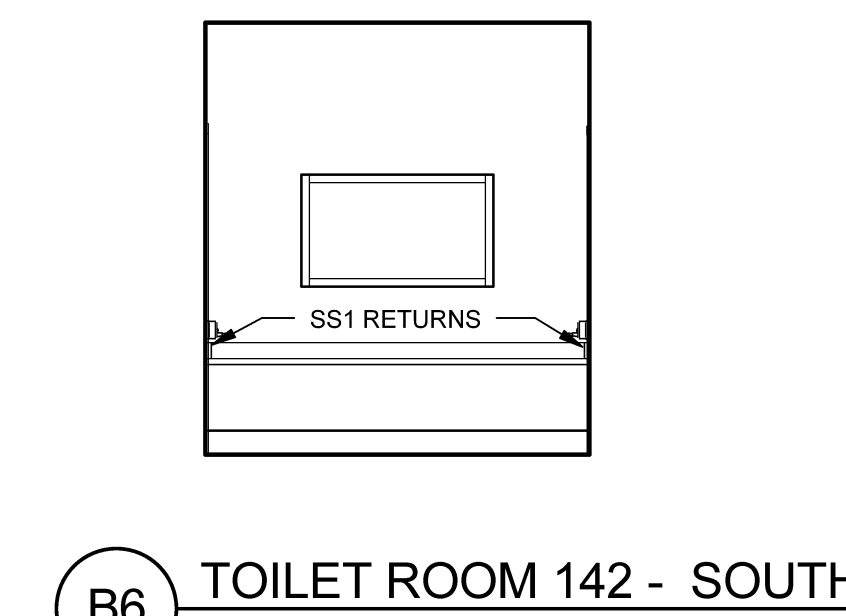

B6 TOILET ROOM 142 - SOUTH SCALE: 1/4" = 1'-0"

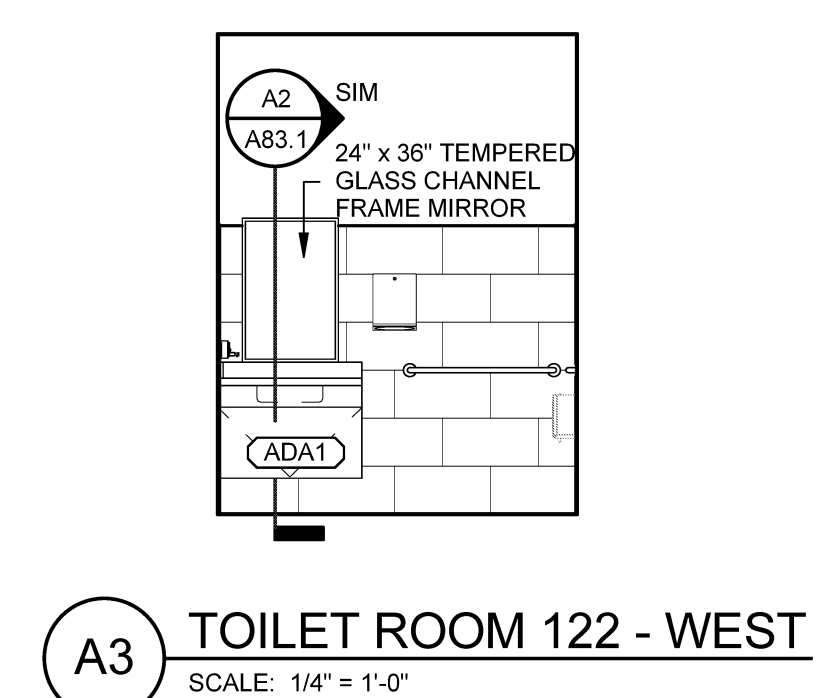

A3 TOILET ROOM 122 - WEST SCALE: 1/4" = 1'-0"

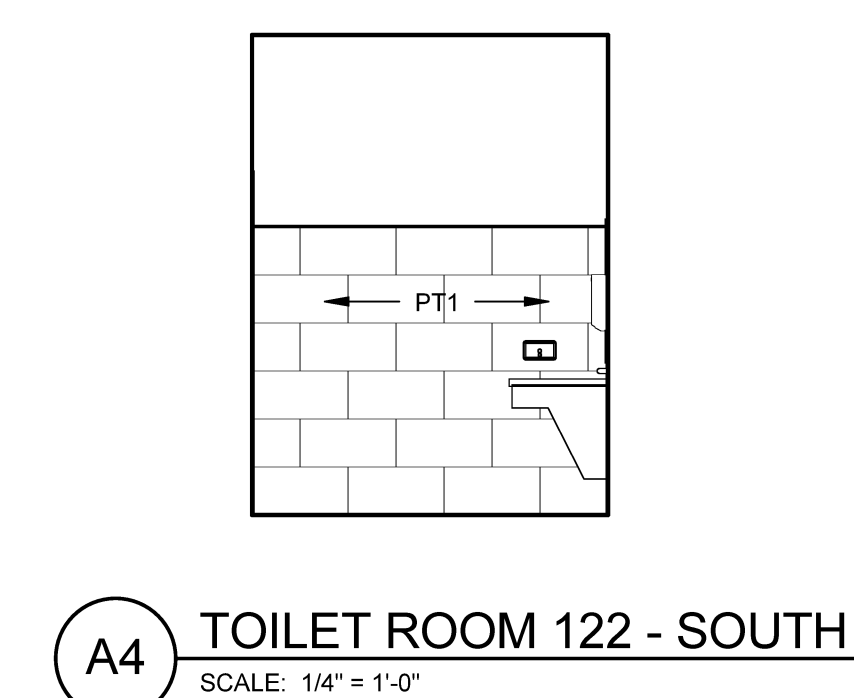

A4 TOILET ROOM 122 - SOUTH SCALE: 1/4" = 1'-0"

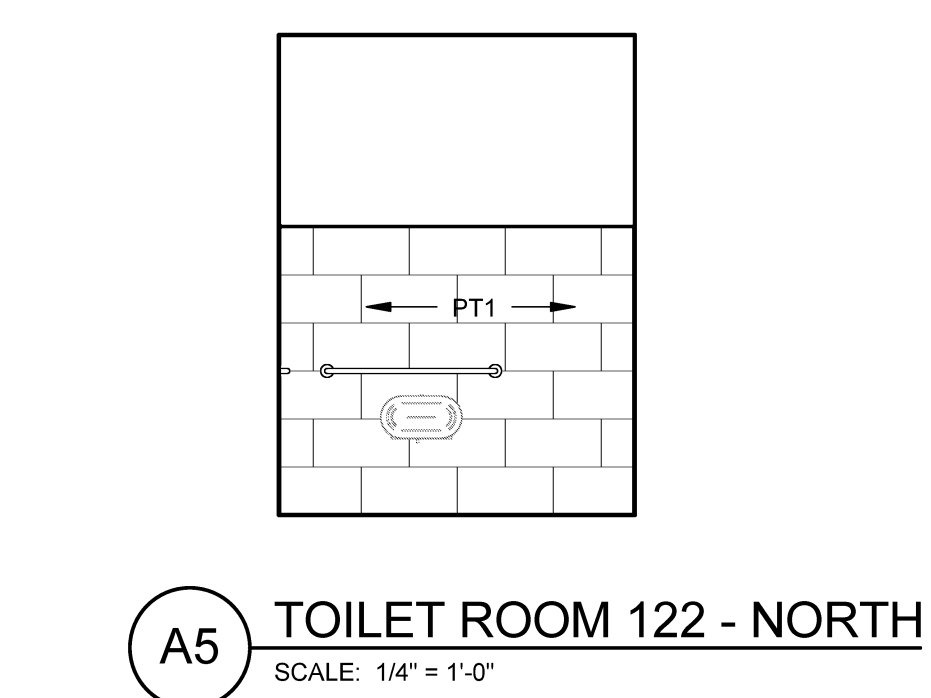

A5 TOILET ROOM 122 - NORTH SCALE: 1/4" = 1'-0"

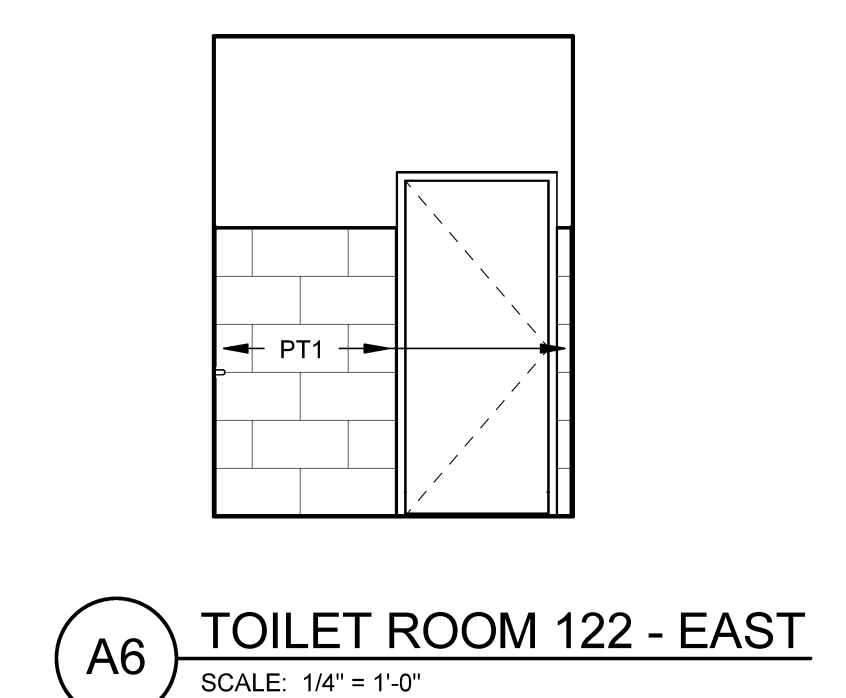

A6 TOILET ROOM 122 - EAST SCALE: 1/4" = 1'-0"

Issues and Revisions

Mark	Date	Description
-	03-25-16	CONSTRUCTION DOCUMENTS
1	04-15-16	ADDENDUM #1
2	07-22-16	CONFORMANCE SET

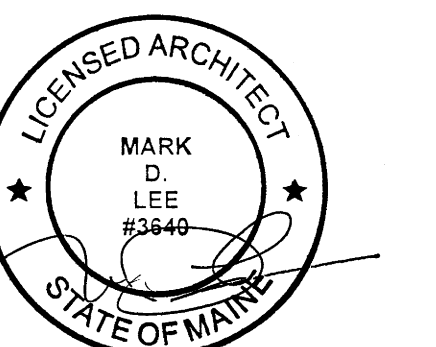

Drawing Scales 1/4" = 1'-0"

PA/PE: MDL © 2016 Harriman Associates  
Drawn By: JAE

INTERIOR ELEVATIONS

A81.5