



HARRIMAN

AUBURN PORTLAND MANCHESTER

JEWISH COMMUNITY ALLIANCE OF SOUTHERN MAINE

PORTLAND, ME

Harriman Project No. 15309

Key Plan

Proj North

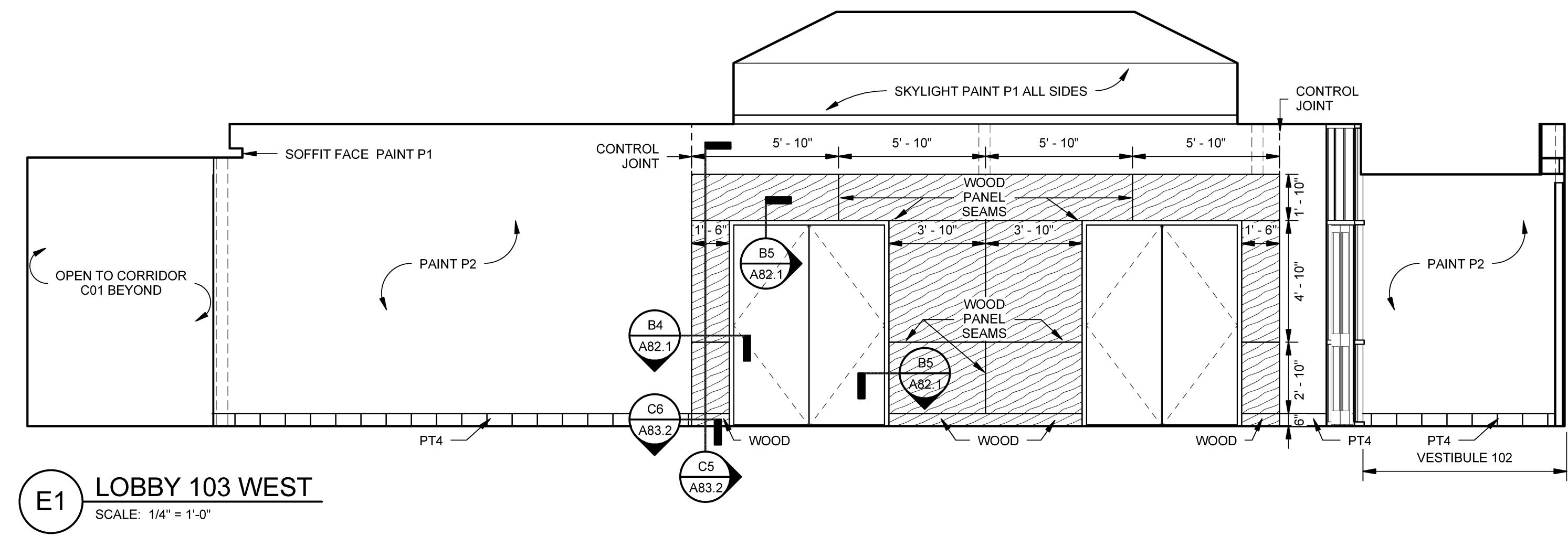
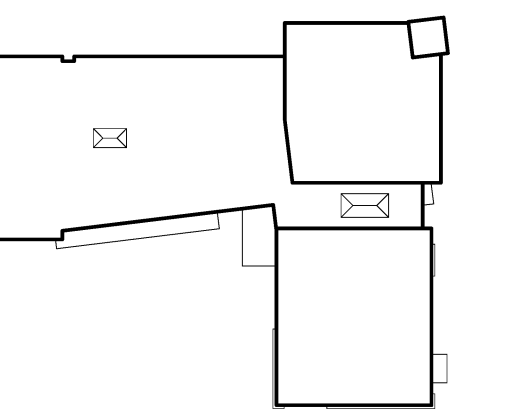

E1 LOBBY 103 WEST  
SCALE: 1/4" = 1'-0"

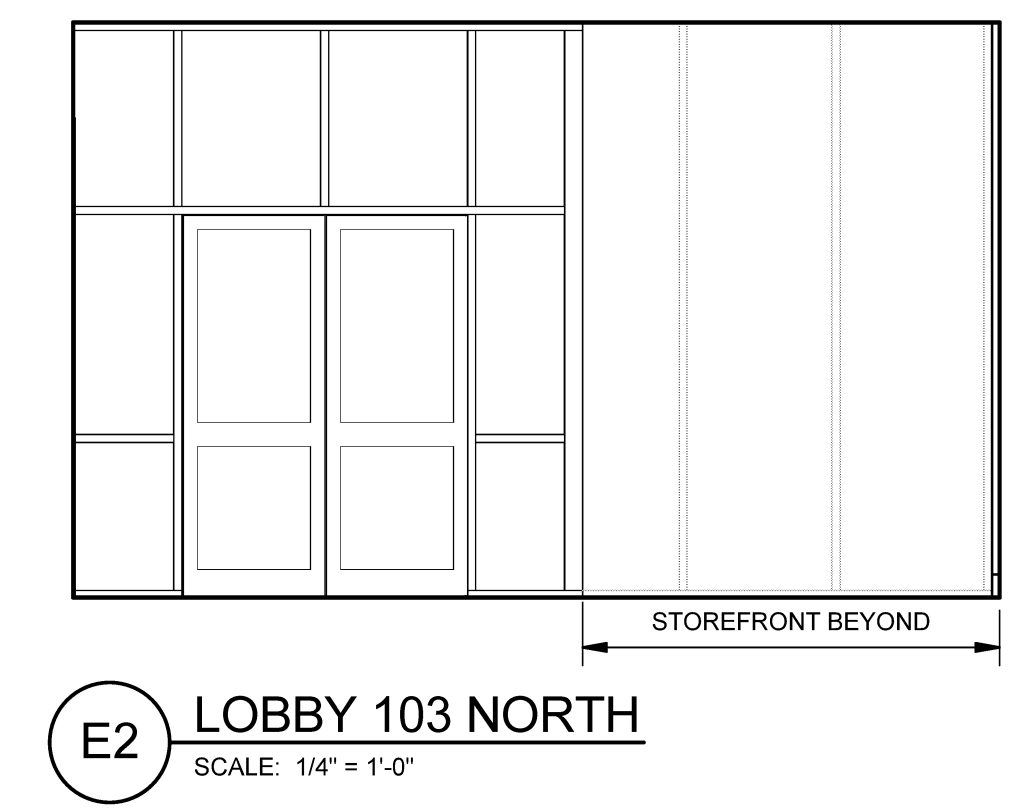

E2 LOBBY 103 NORTH  
SCALE: 1/4" = 1'-0"

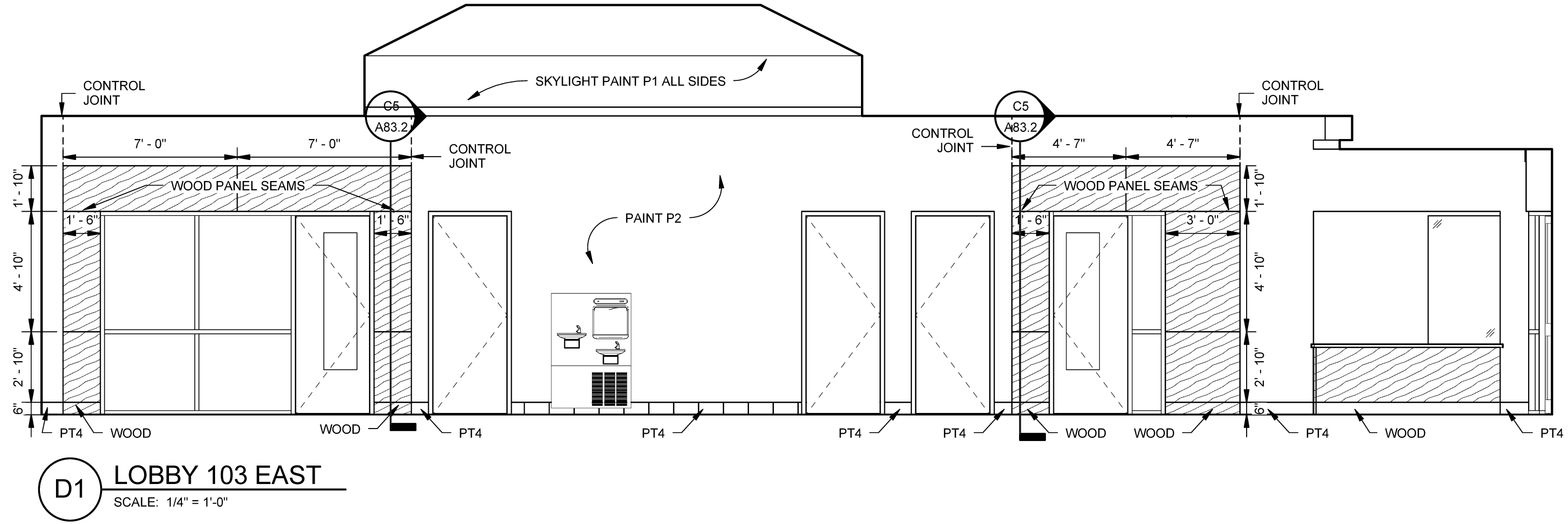

D1 LOBBY 103 EAST  
SCALE: 1/4" = 1'-0"

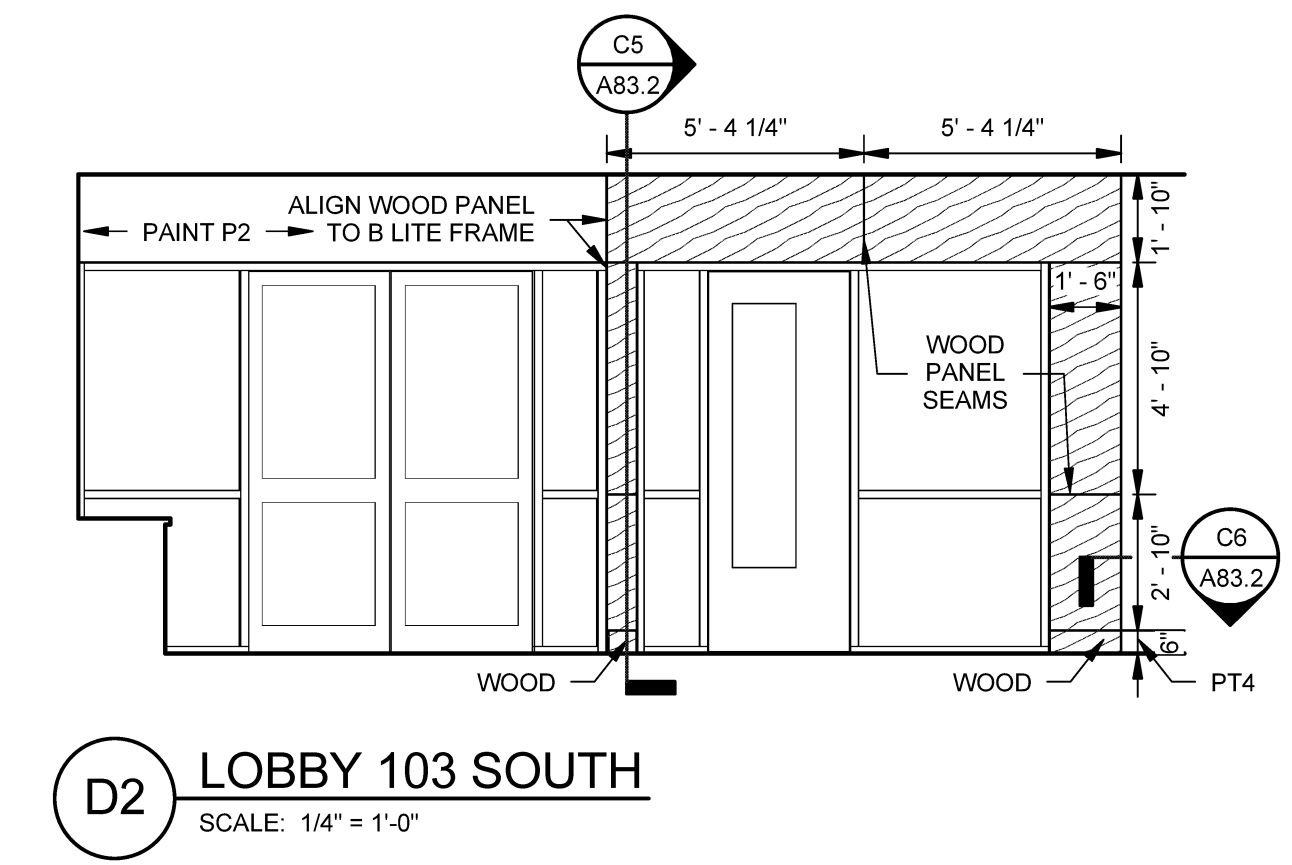

D2 LOBBY 103 SOUTH  
SCALE: 1/4" = 1'-0"

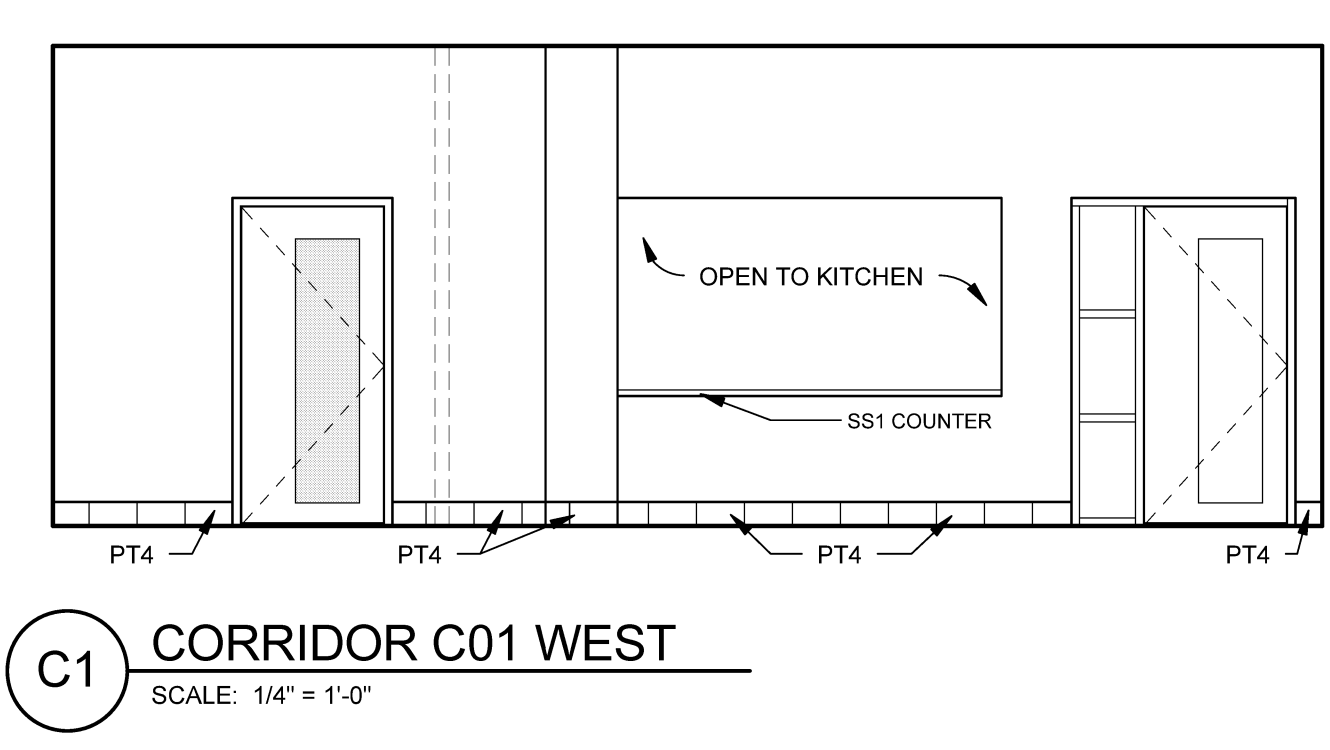

C1 CORRIDOR C01 WEST  
SCALE: 1/4" = 1'-0"

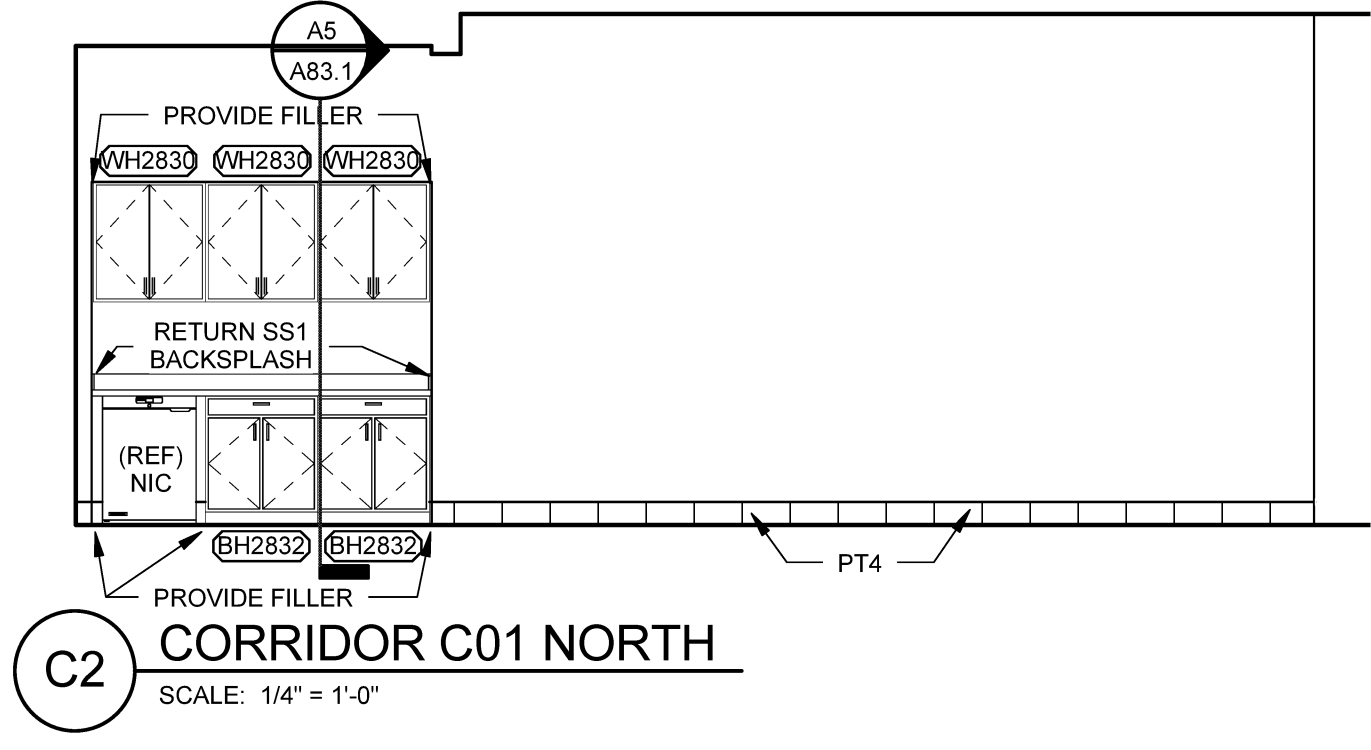

C2 CORRIDOR C01 NORTH  
SCALE: 1/4" = 1'-0"

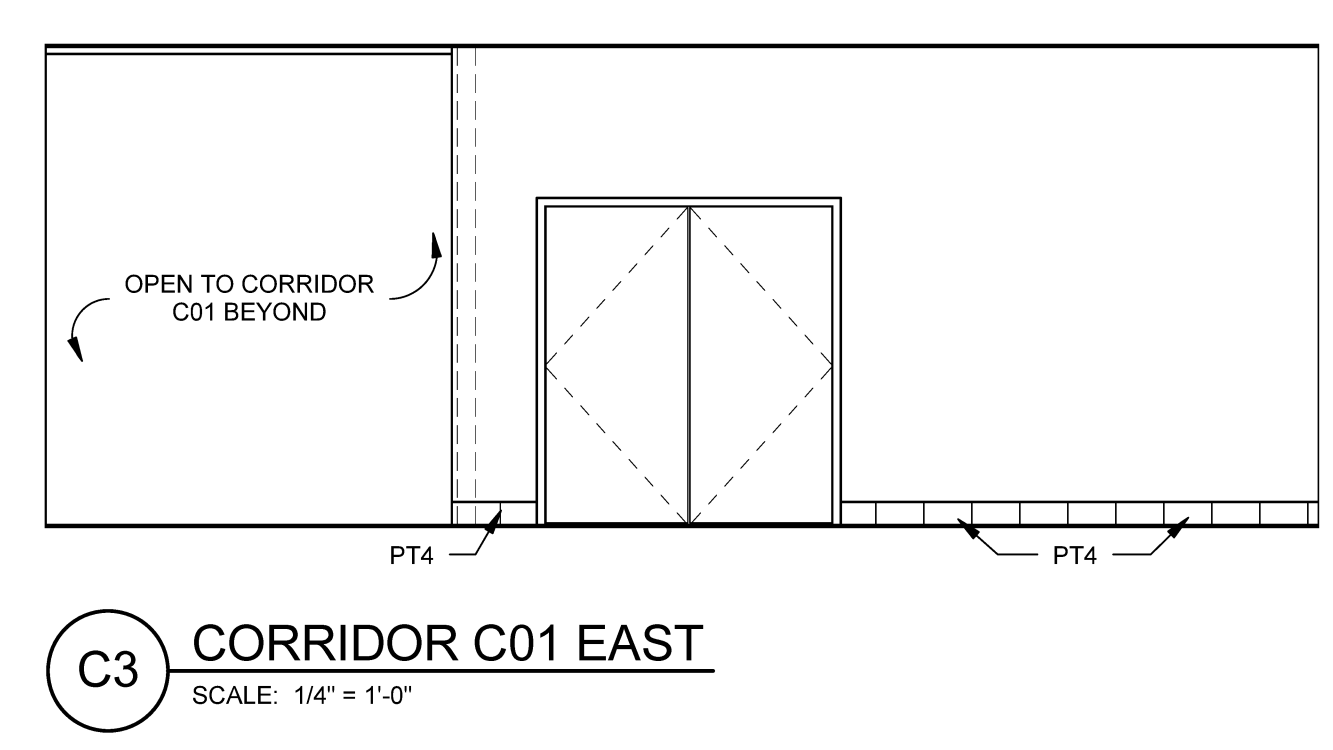

C3 CORRIDOR C01 EAST  
SCALE: 1/4" = 1'-0"

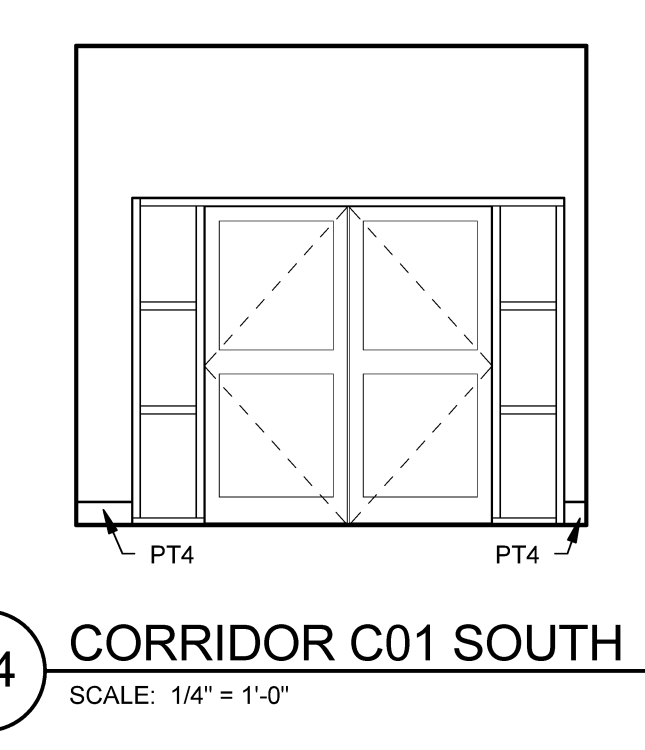

C4 CORRIDOR C01 SOUTH  
SCALE: 1/4" = 1'-0"

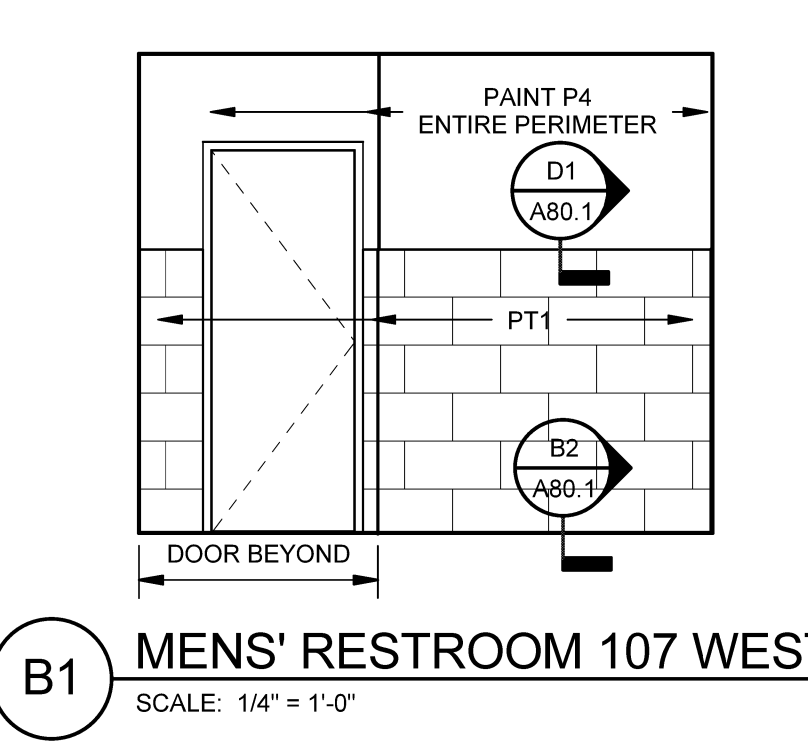

B1 MENS' RESTROOM 107 WEST  
SCALE: 1/4" = 1'-0"

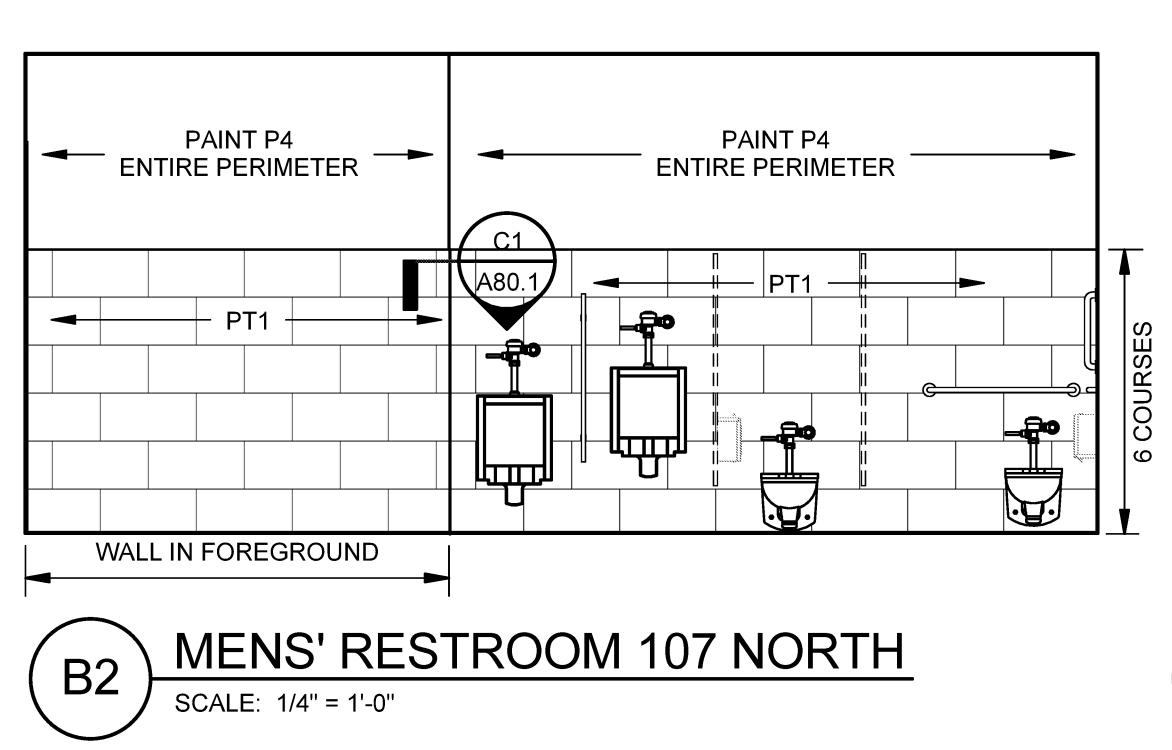

B2 MENS' RESTROOM 107 NORTH  
SCALE: 1/4" = 1'-0"

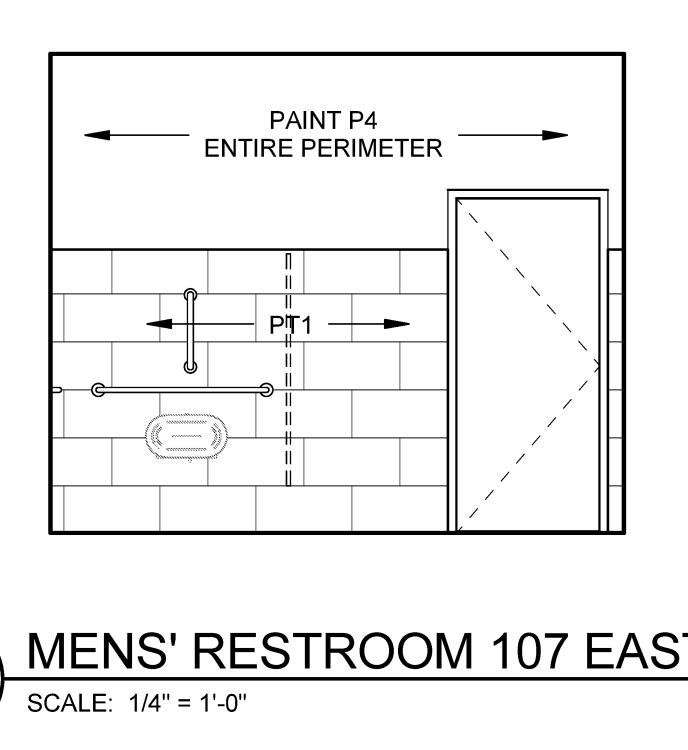

B3 MENS' RESTROOM 107 EAST  
SCALE: 1/4" = 1'-0"

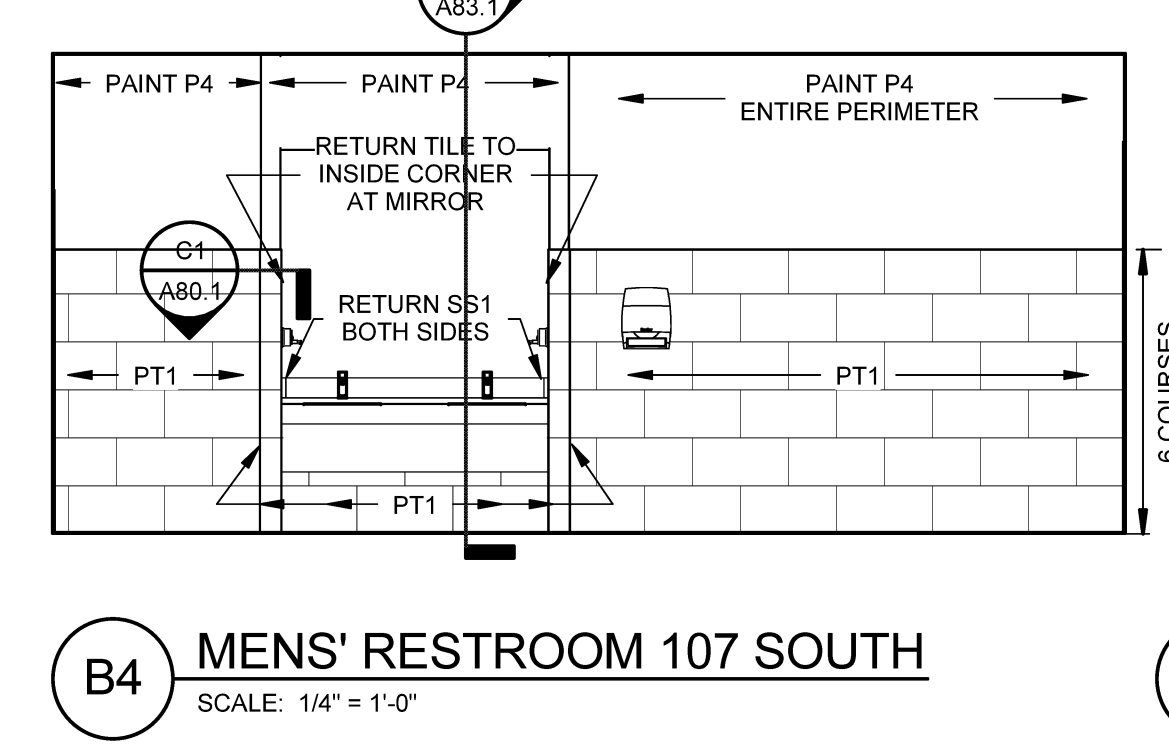

B4 MENS' RESTROOM 107 SOUTH  
SCALE: 1/4" = 1'-0"

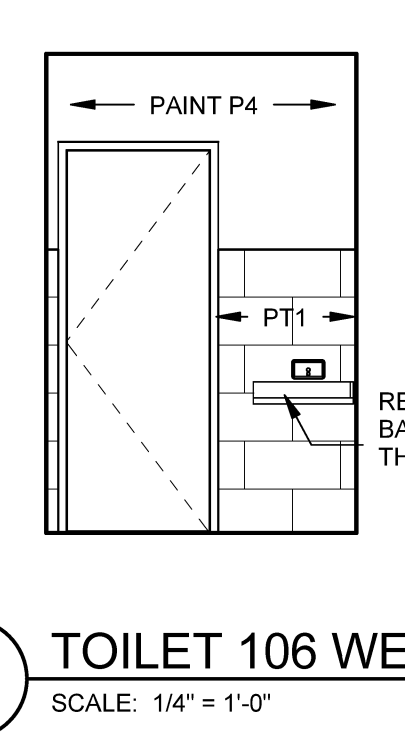

B5 TOILET 106 WEST  
SCALE: 1/4" = 1'-0"

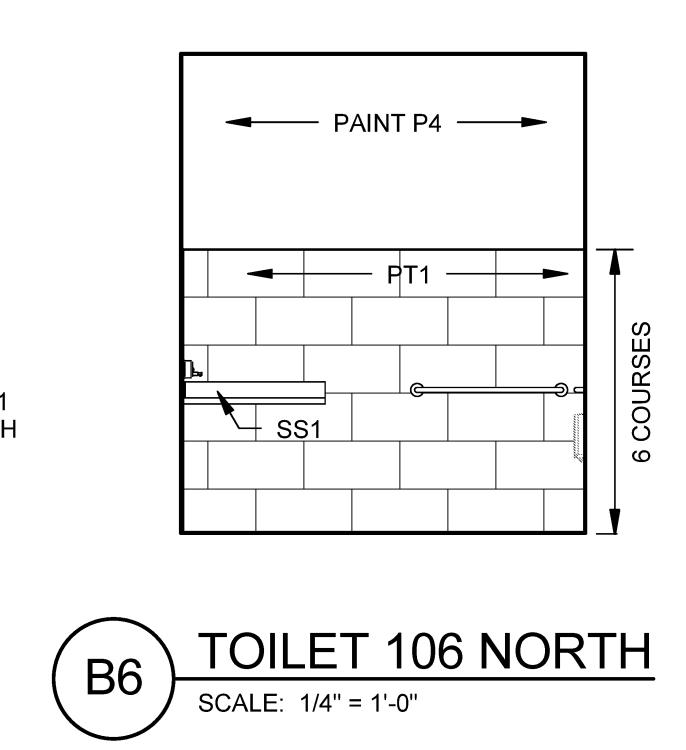

B6 TOILET 106 NORTH  
SCALE: 1/4" = 1'-0"

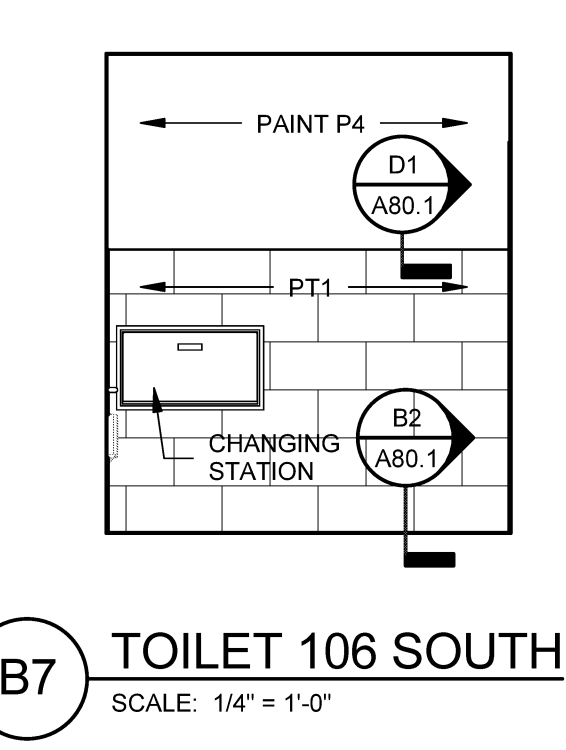

B7 TOILET 106 SOUTH  
SCALE: 1/4" = 1'-0"

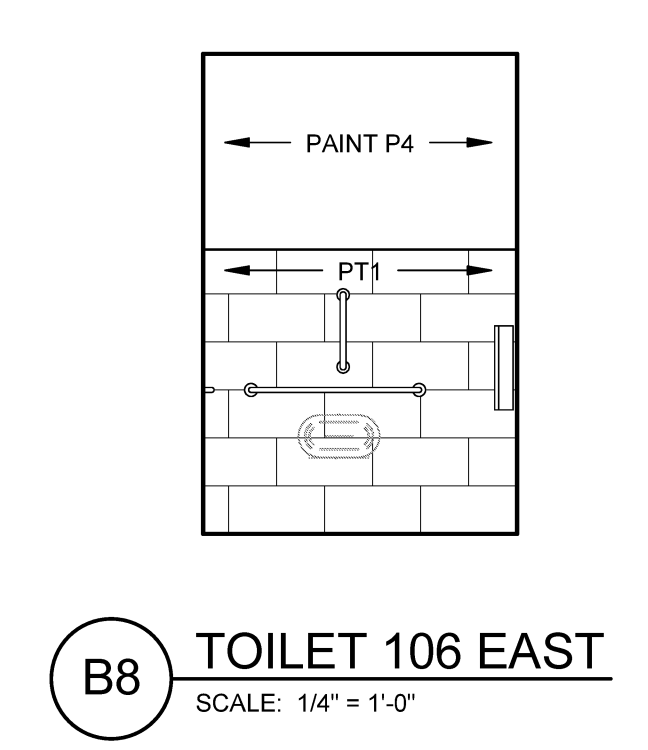

B8 TOILET 106 EAST  
SCALE: 1/4" = 1'-0"

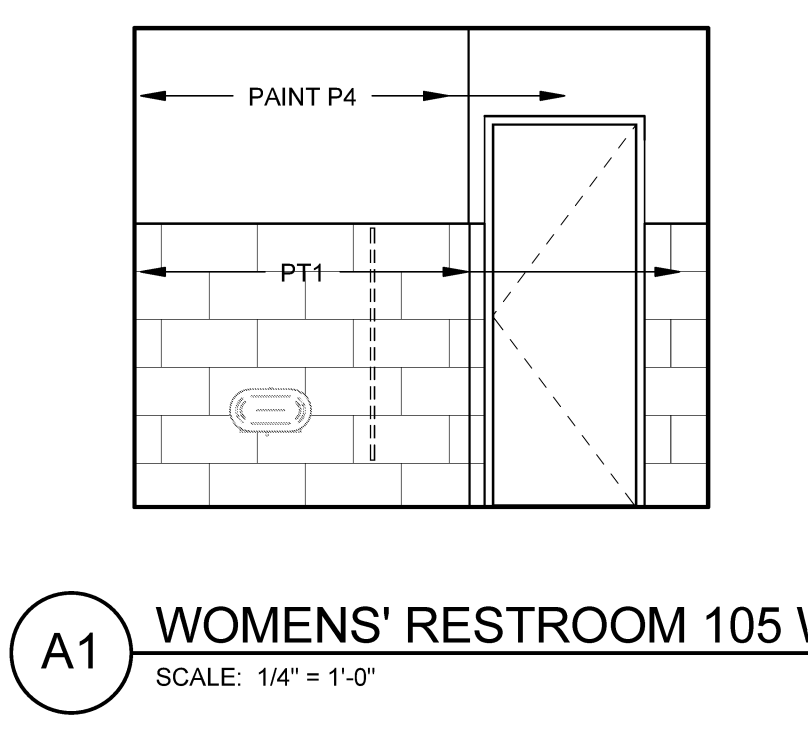

A1 WOMENS' RESTROOM 105 WEST  
SCALE: 1/4" = 1'-0"

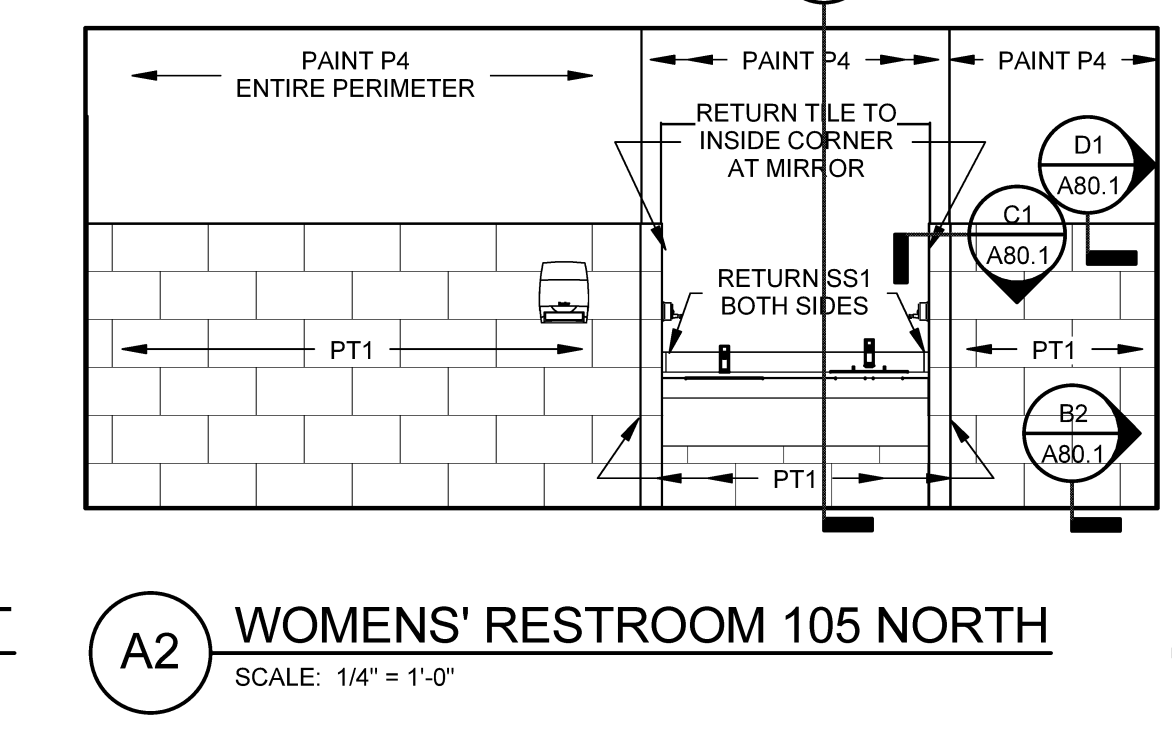

A2 WOMENS' RESTROOM 105 NORTH  
SCALE: 1/4" = 1'-0"

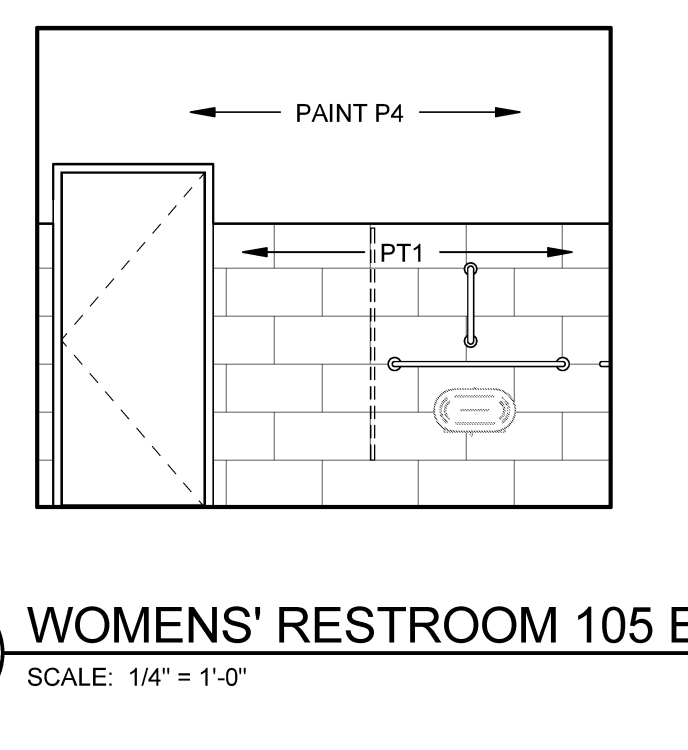

A3 WOMENS' RESTROOM 105 EAST  
SCALE: 1/4" = 1'-0"

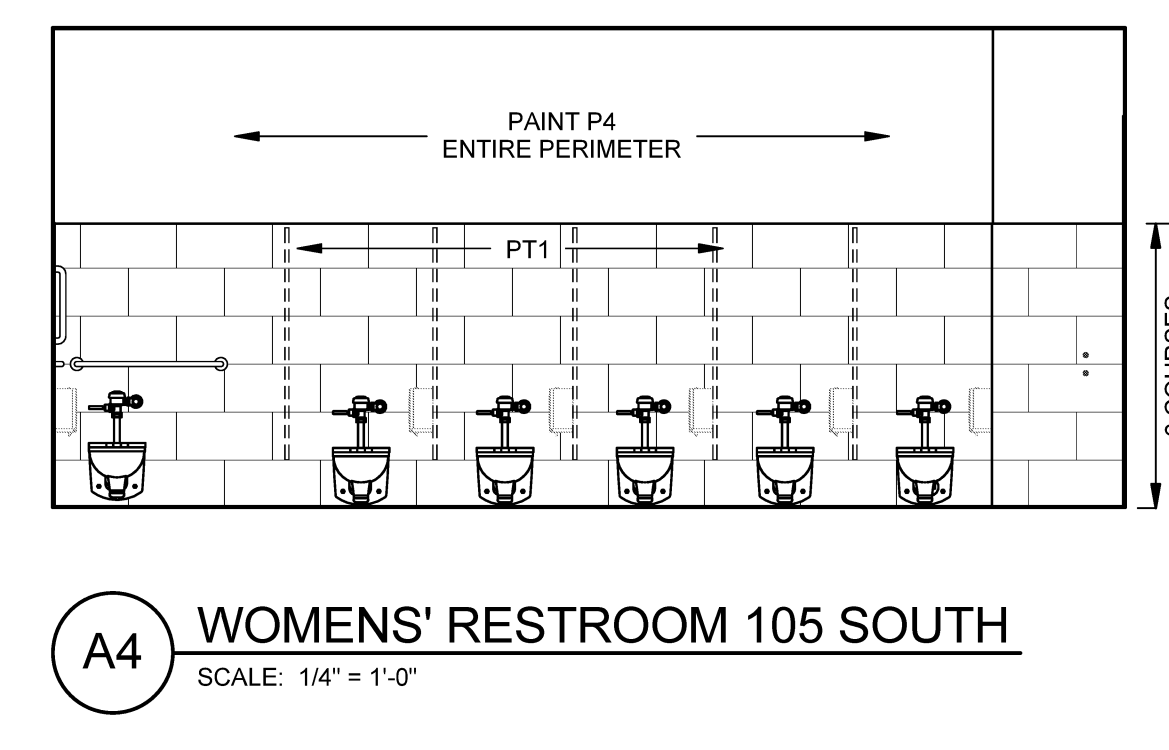

A4 WOMENS' RESTROOM 105 SOUTH  
SCALE: 1/4" = 1'-0"

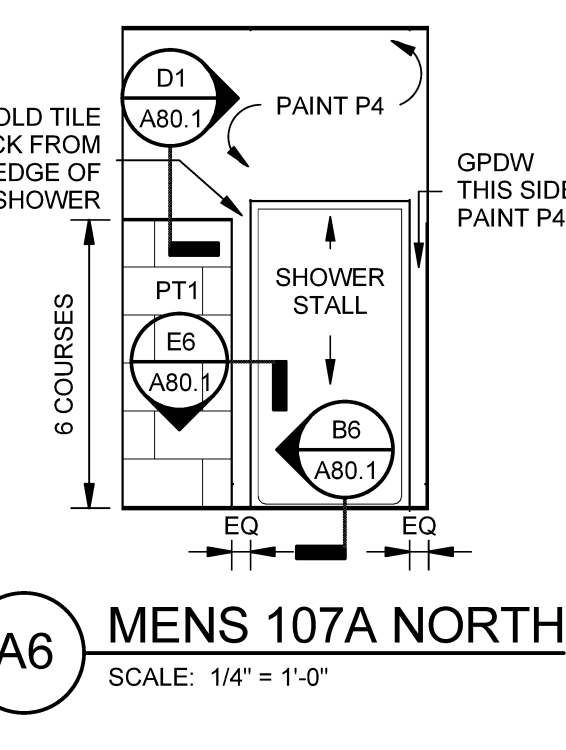

A6 MENS 107A NORTH  
SCALE: 1/4" = 1'-0"

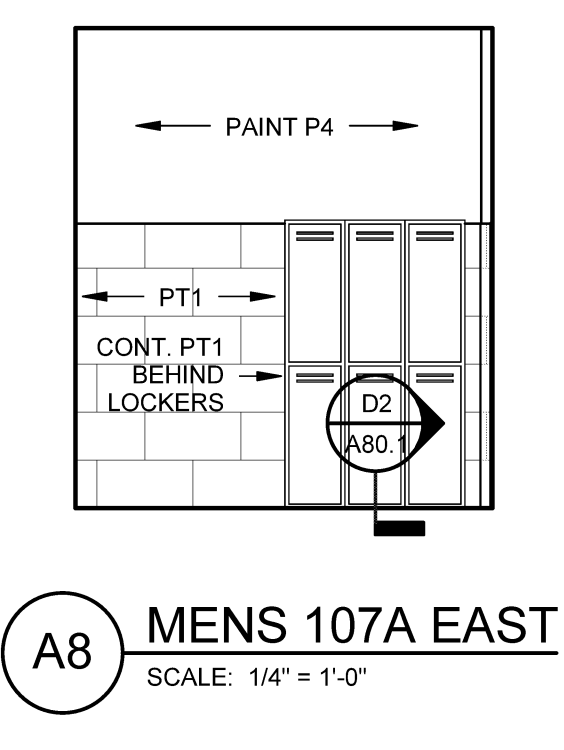

A8 MENS 107A EAST  
SCALE: 1/4" = 1'-0"

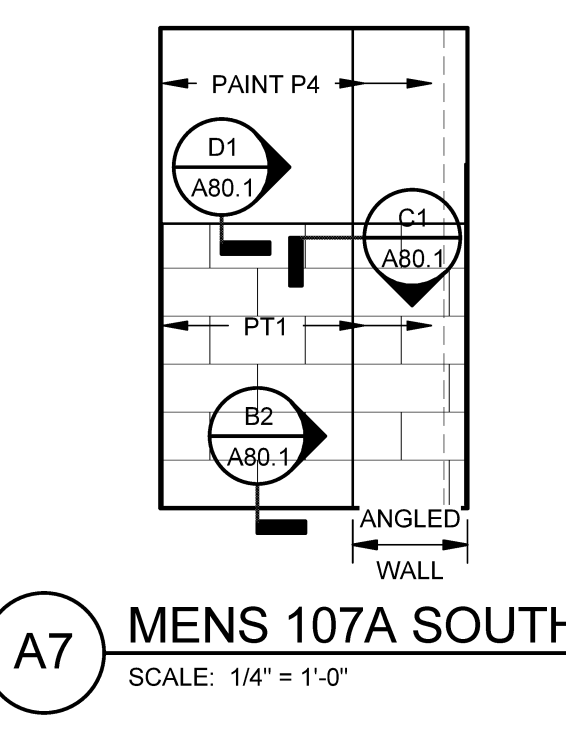

A7 MENS 107A SOUTH  
SCALE: 1/4" = 1'-0"

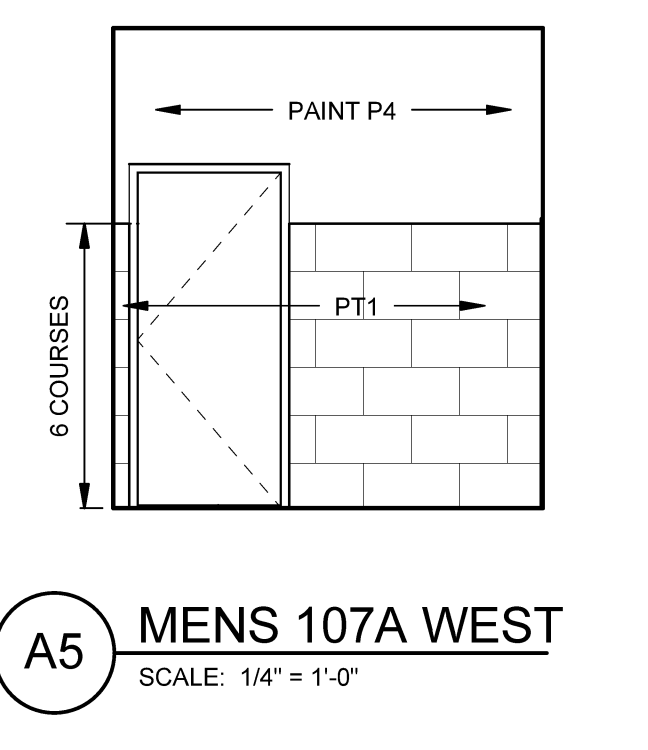

A5 MENS 107A WEST  
SCALE: 1/4" = 1'-0"

Mark	Date	Description
-	09-04-15	DESIGN DEVELOPMENT REVIEW
-	03-25-16	CONSTRUCTION DOCUMENTS

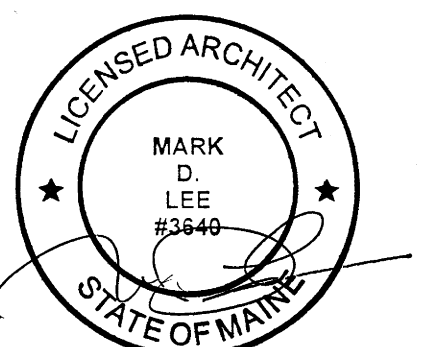

Drawing Scales: 1/4" = 1'-0"

PA/PE: MDL © 2016 Harriman Associates  
Drawn By: JAE

INTERIOR ELEVATIONS

A81.1

Plot Date: 3/29/2016 1:23:57 PM