

E1 PRECAST AND BRICK PROFILES
SCALE: 1 1/2" = 1'-0"

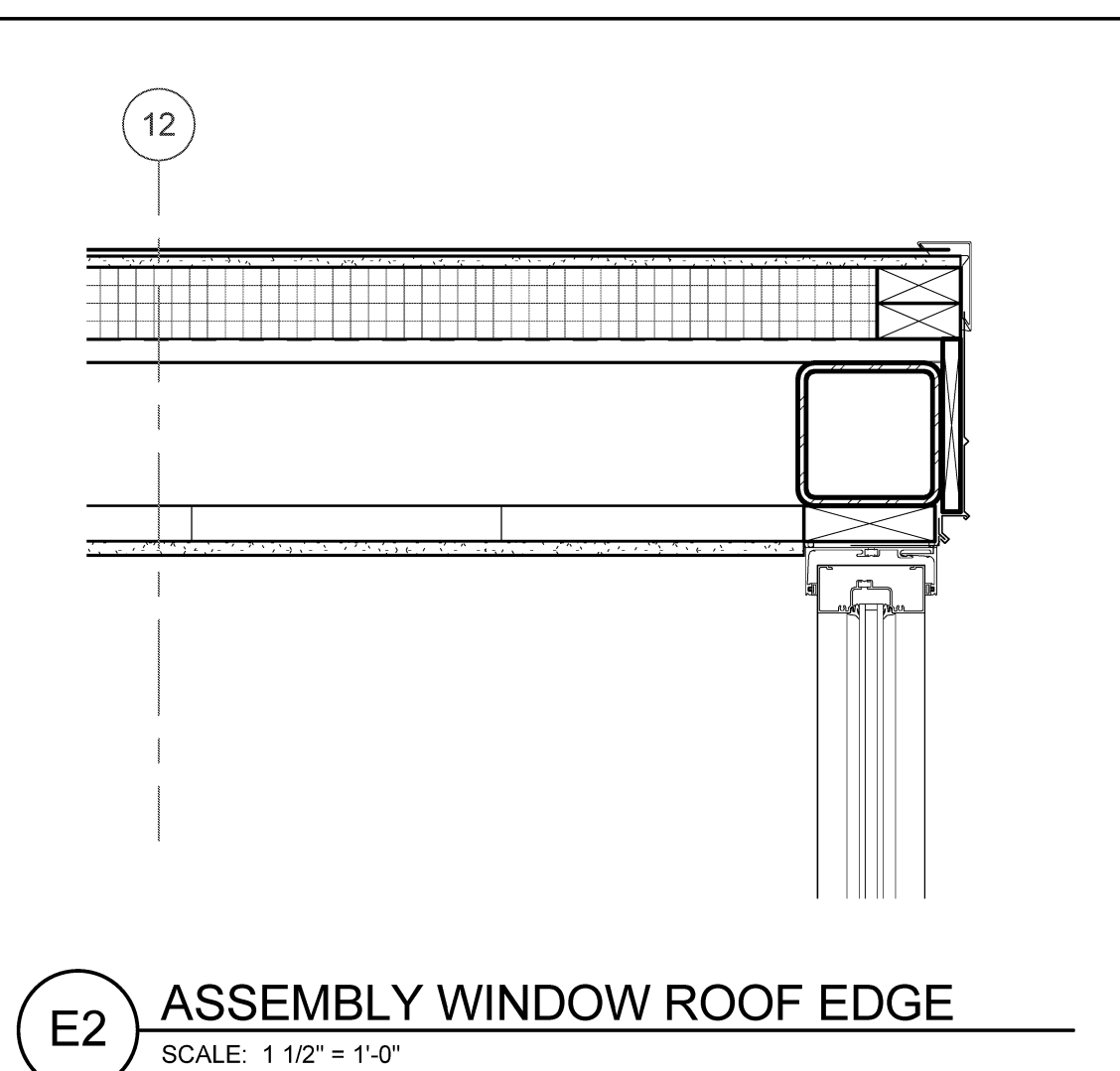

E2 ASSEMBLY WINDOW ROOF EDGE
SCALE: 1 1/2" = 1'-0"



E3 SECTION AT LOBBY - Callout 1
SCALE: 1 1/2" = 1'-0"

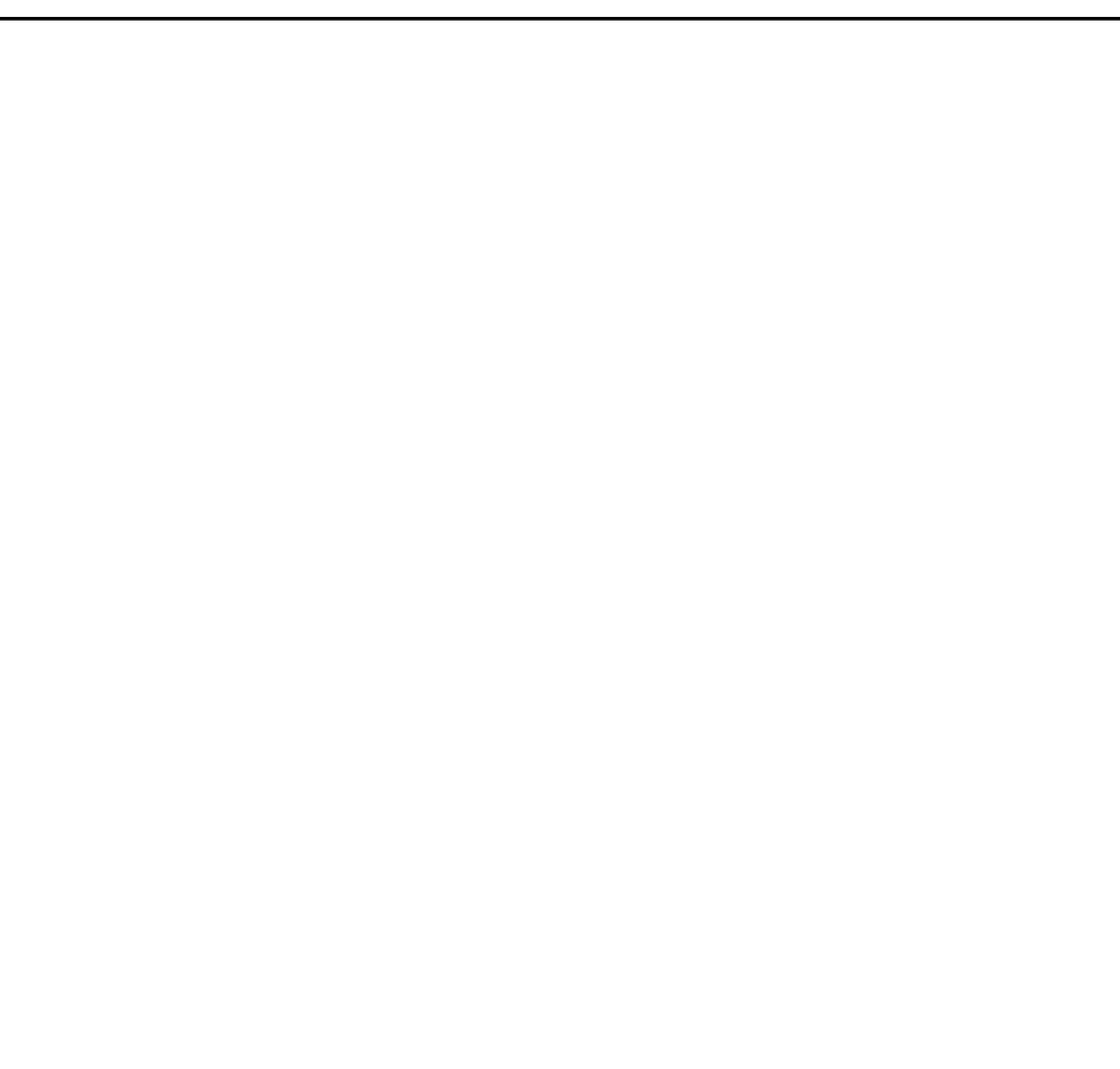

E4 STOREFRONT DETAIL AT ROOF EDGE
SCALE: 1 1/2" = 1'-0"



E5 ROOF EDGE AT ASSEMBLY ROOF
SCALE: 1 1/2" = 1'-0"

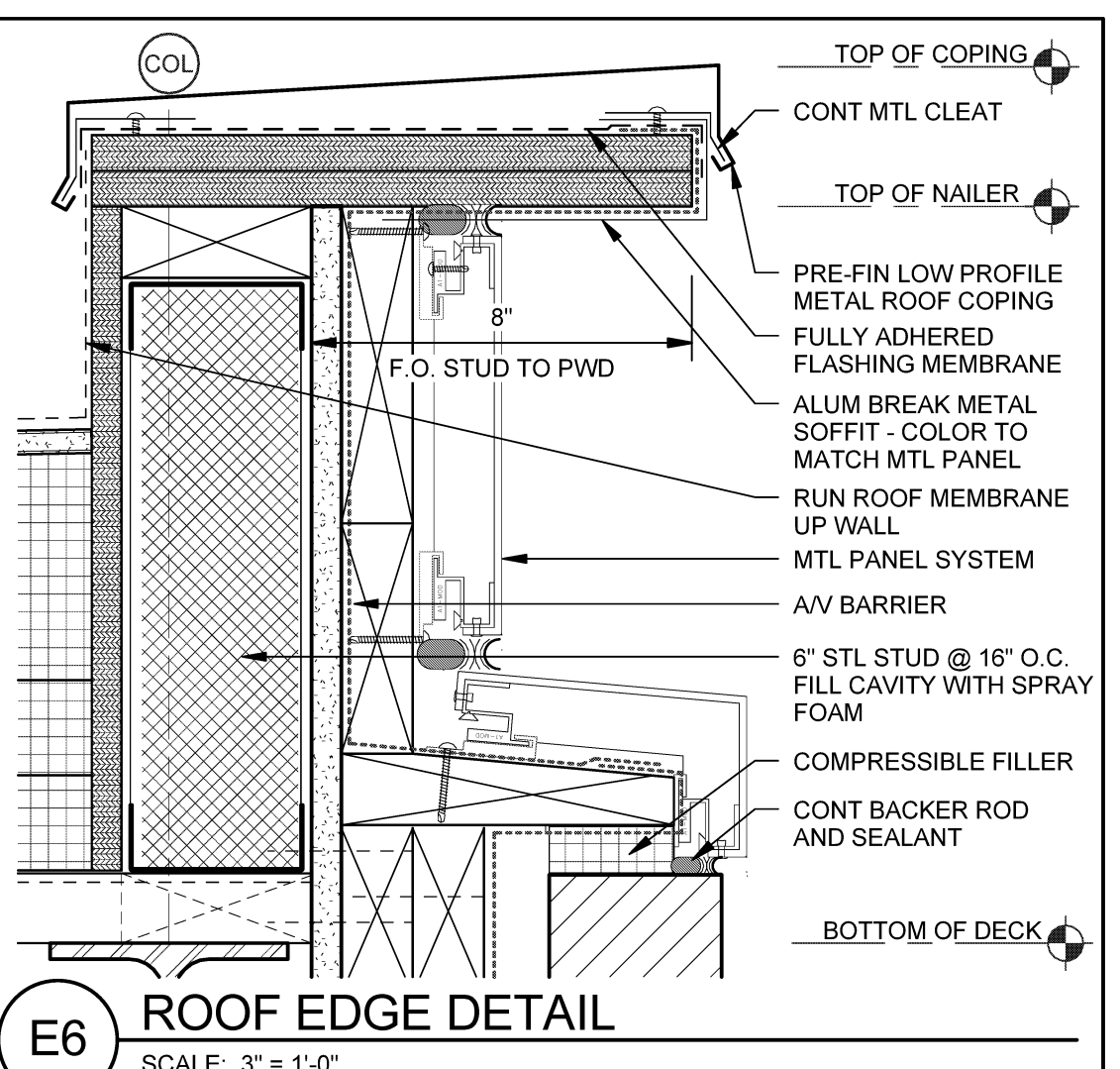

E6 ROOF EDGE DETAIL
SCALE: 3" = 1'-0"

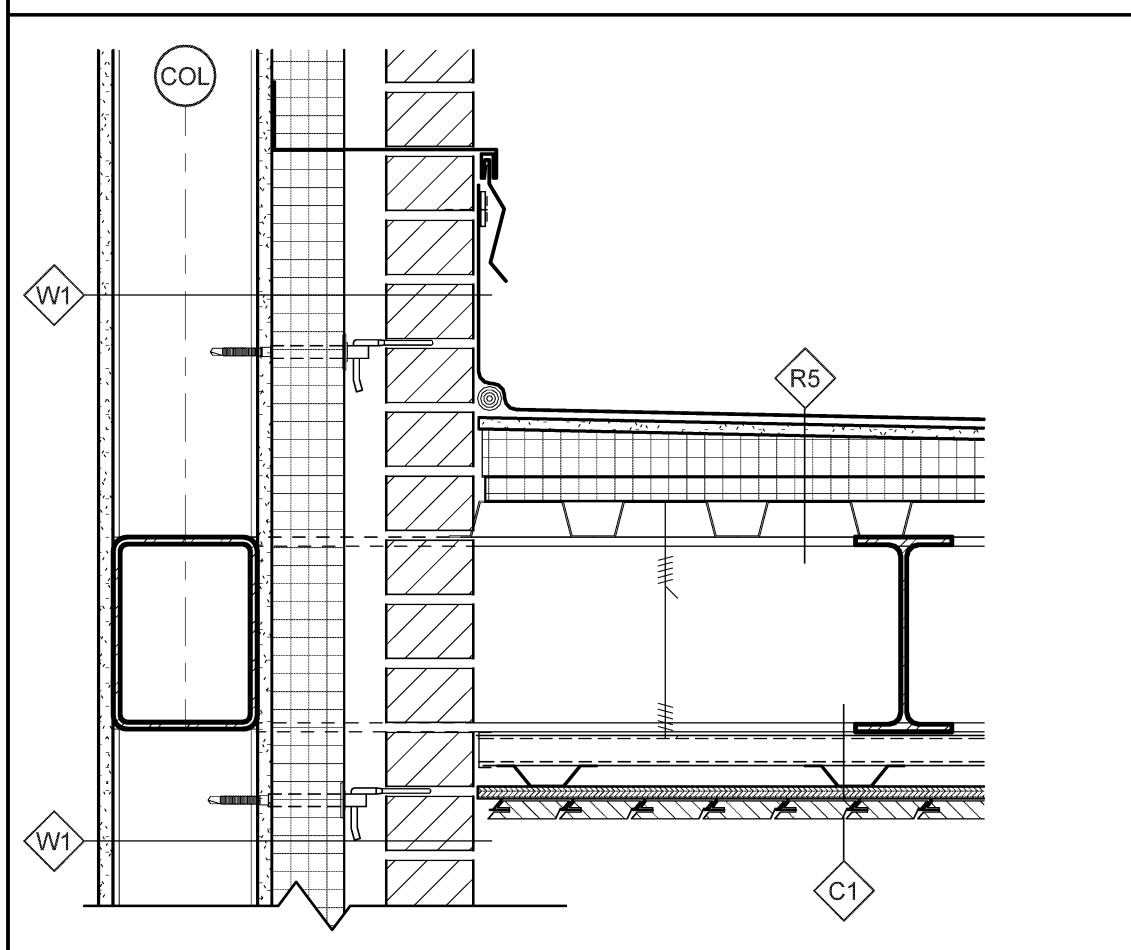

D1 DETAIL AT ENTRY CANOPY
SCALE: 1 1/2" = 1'-0"

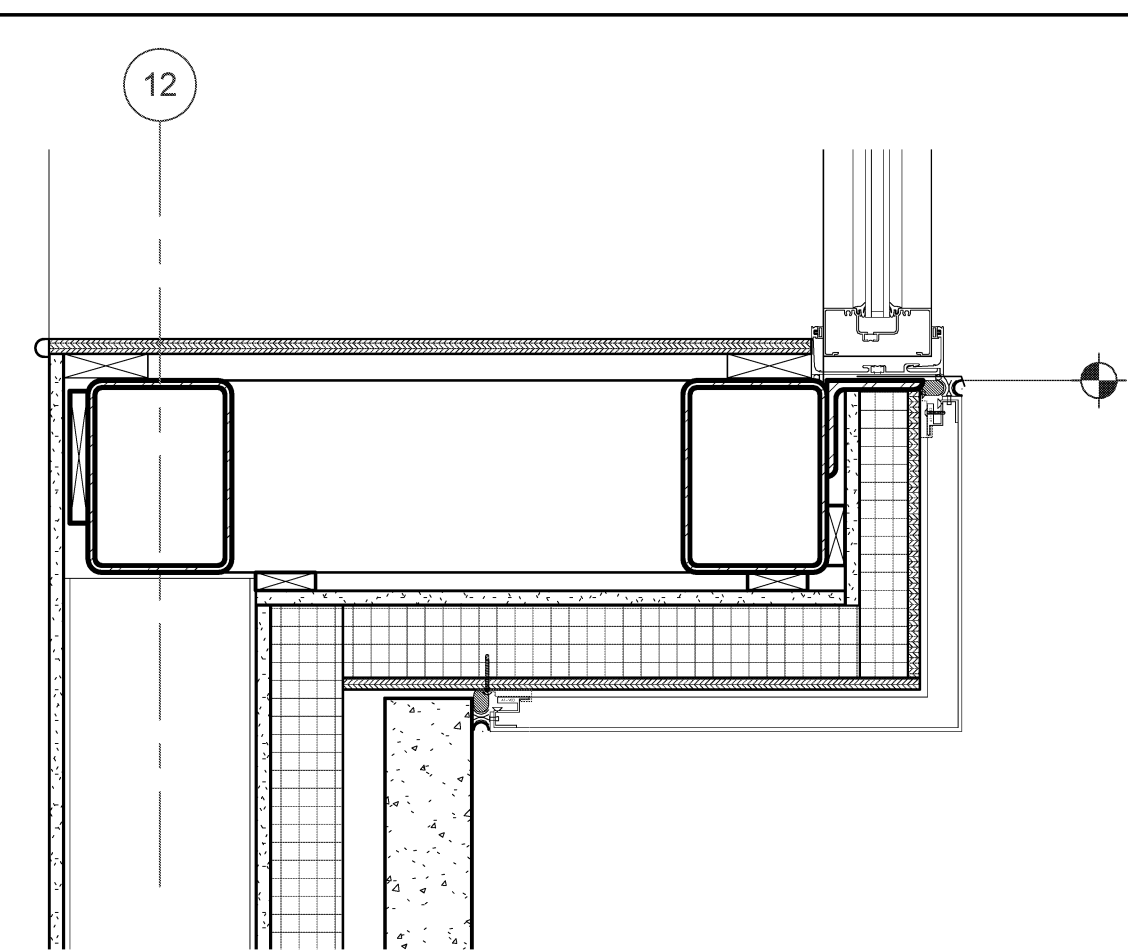

D2 DETAIL AT ASSEMBLY WINDOW
SCALE: 1 1/2" = 1'-0"



D3 SECTION AT LOBBY - Callout 1
SCALE: 1 1/2" = 1'-0"

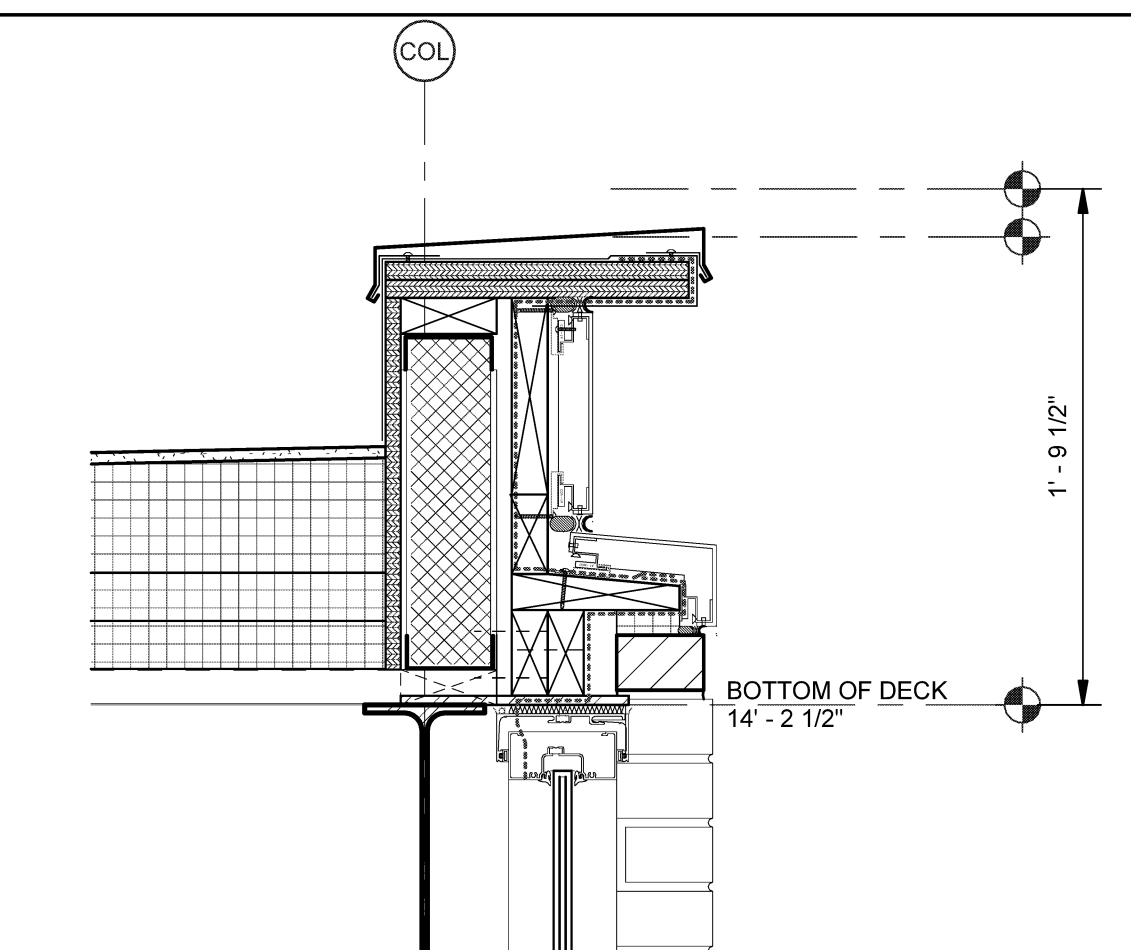

D4 STOREFRONT DETAIL AT ROOF EDGE
SCALE: 1 1/2" = 1'-0"

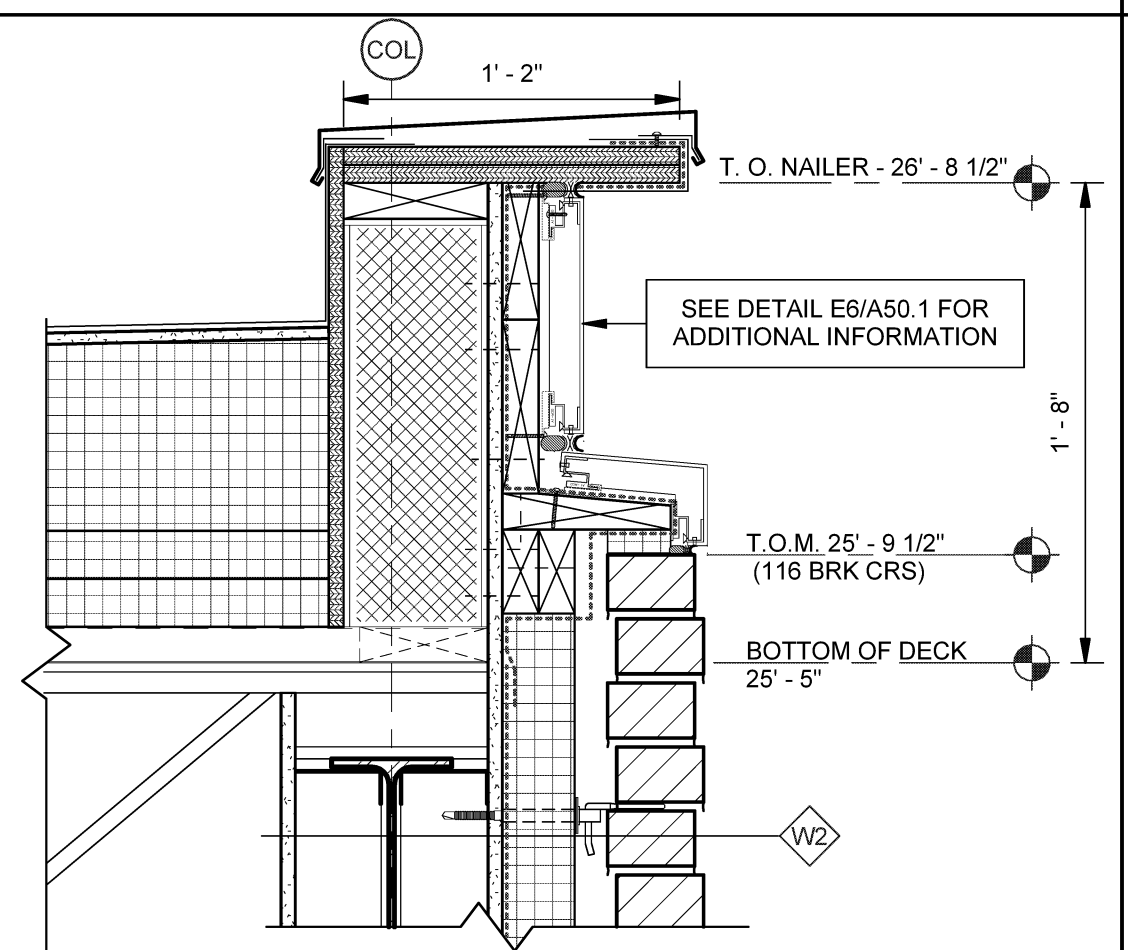

D5 ROOF EDGE AT ASSEMBLY ROOF
SCALE: 1 1/2" = 1'-0"

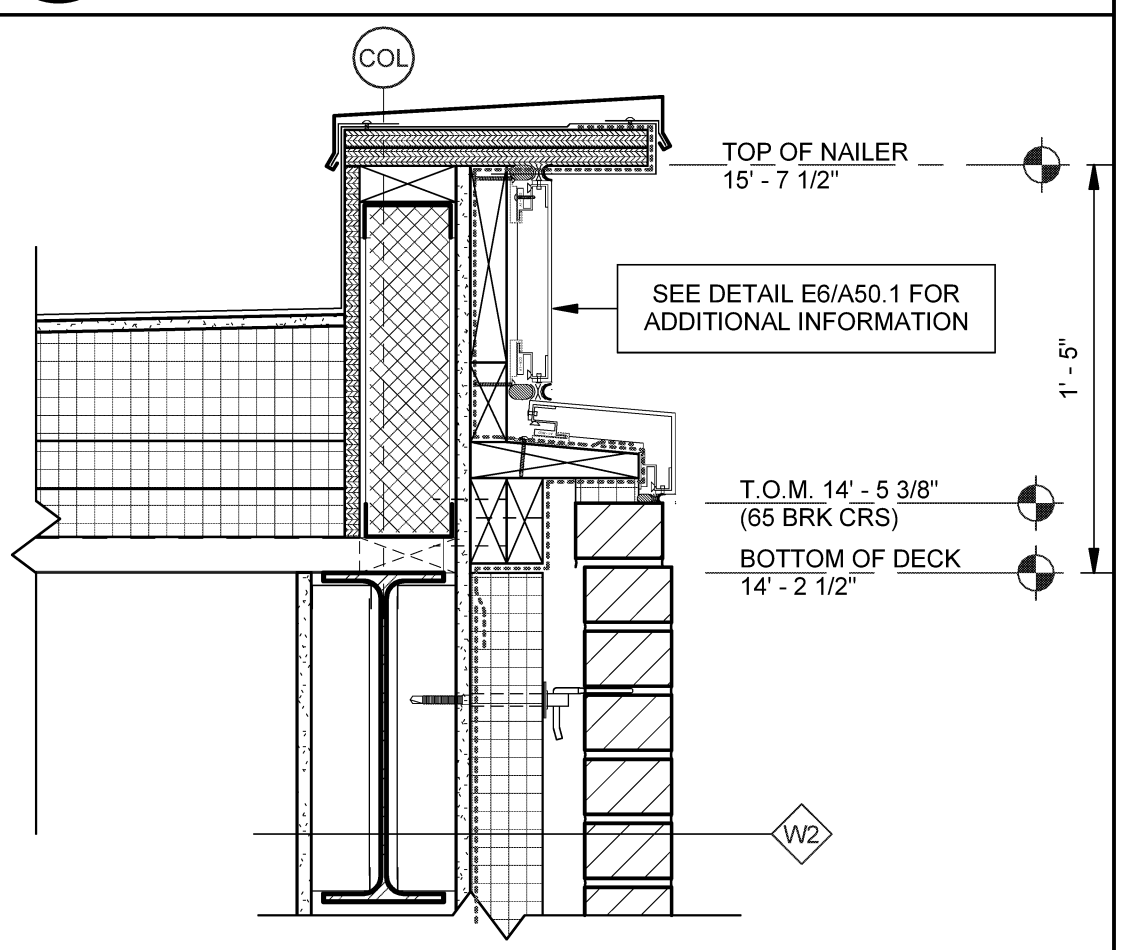

D6 ROOF EDGE AT LOW WALL
SCALE: 1 1/2" = 1'-0"

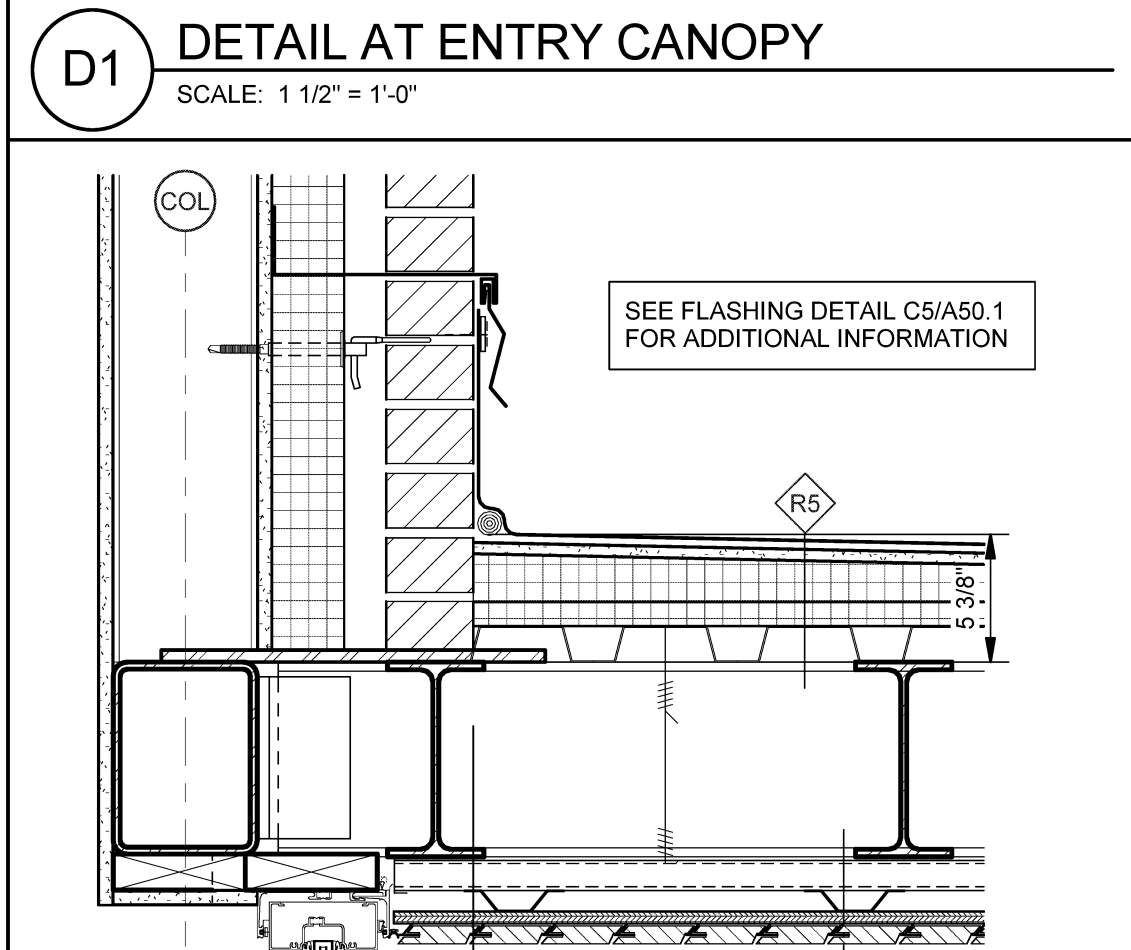

C1 STOREFRONT HEAD AT CANOPY
SCALE: 1 1/2" = 1'-0"

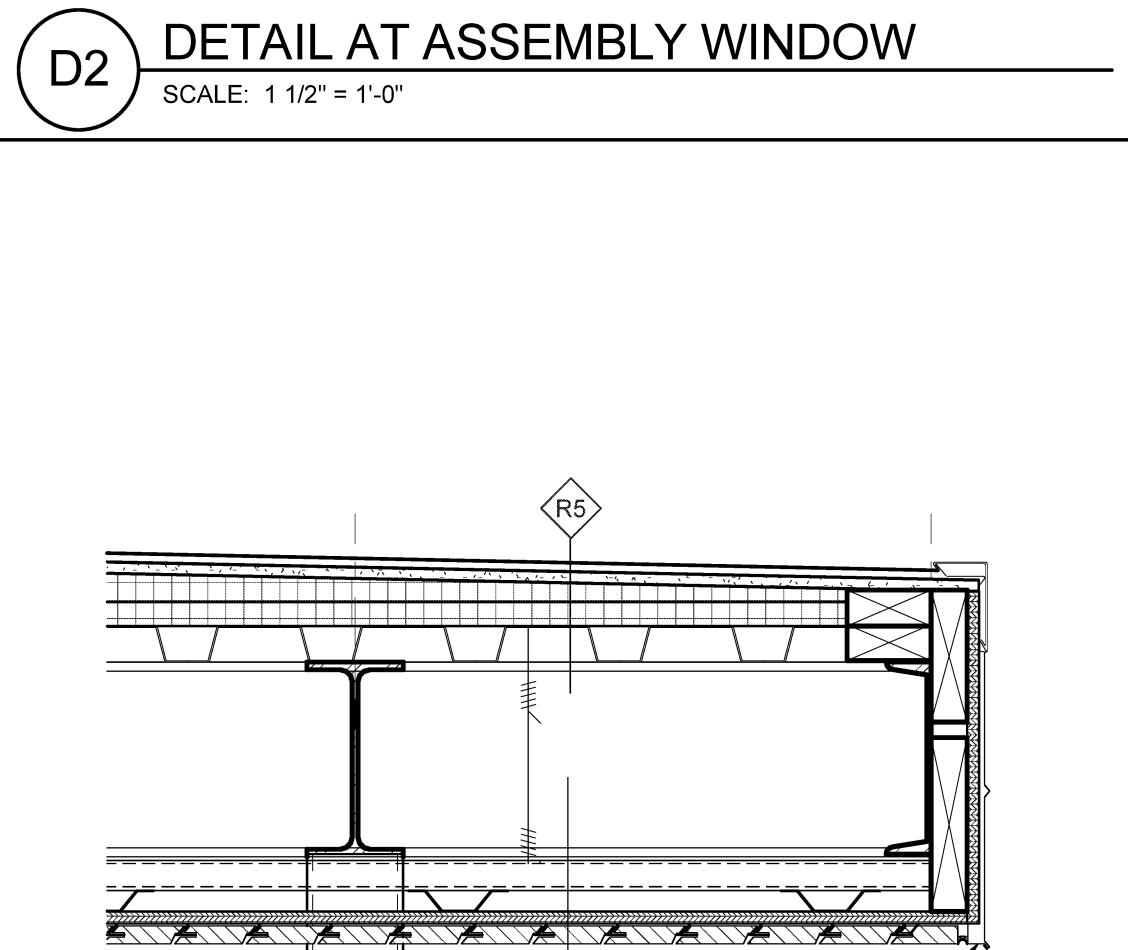

C2 DETAIL AT CANOPY
SCALE: 1 1/2" = 1'-0"

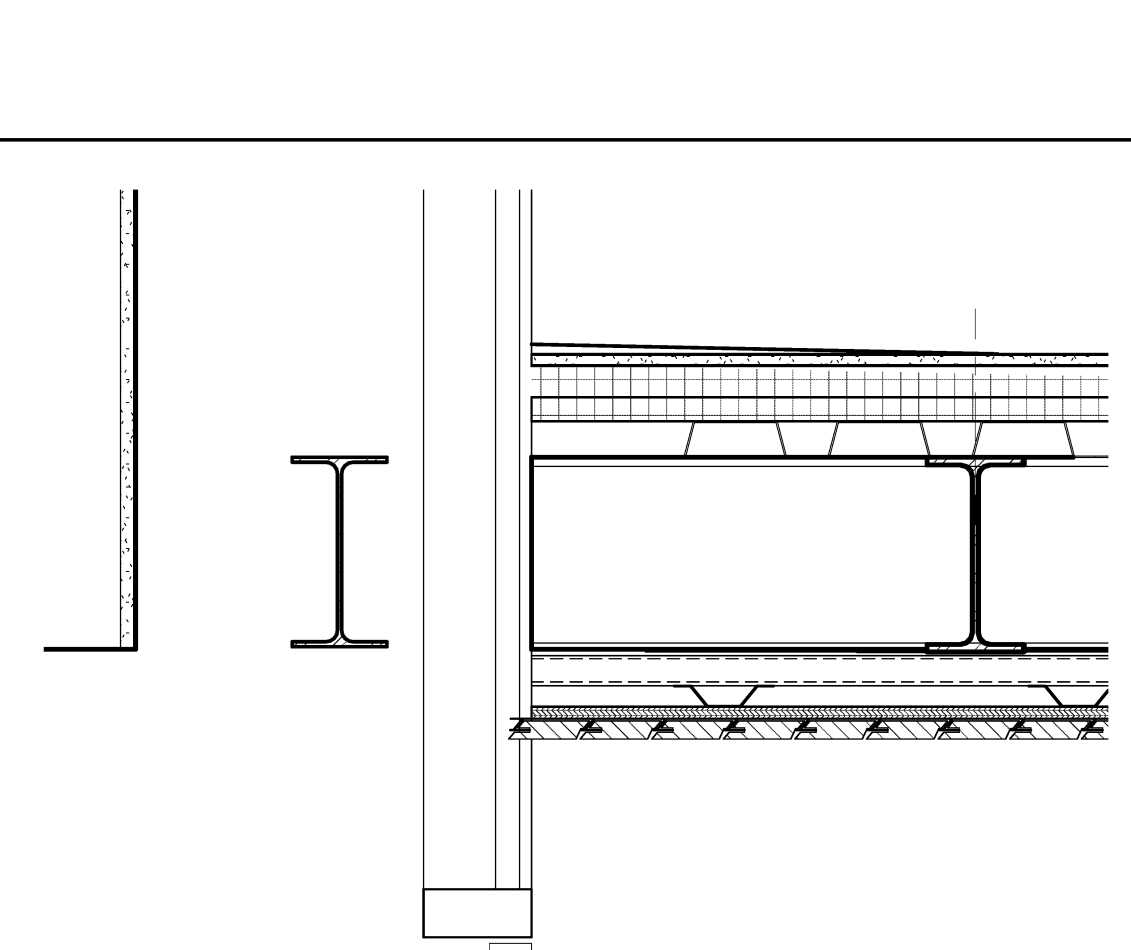

C3 SECTION AT LOBBY - Callout 1
SCALE: 1 1/2" = 1'-0"

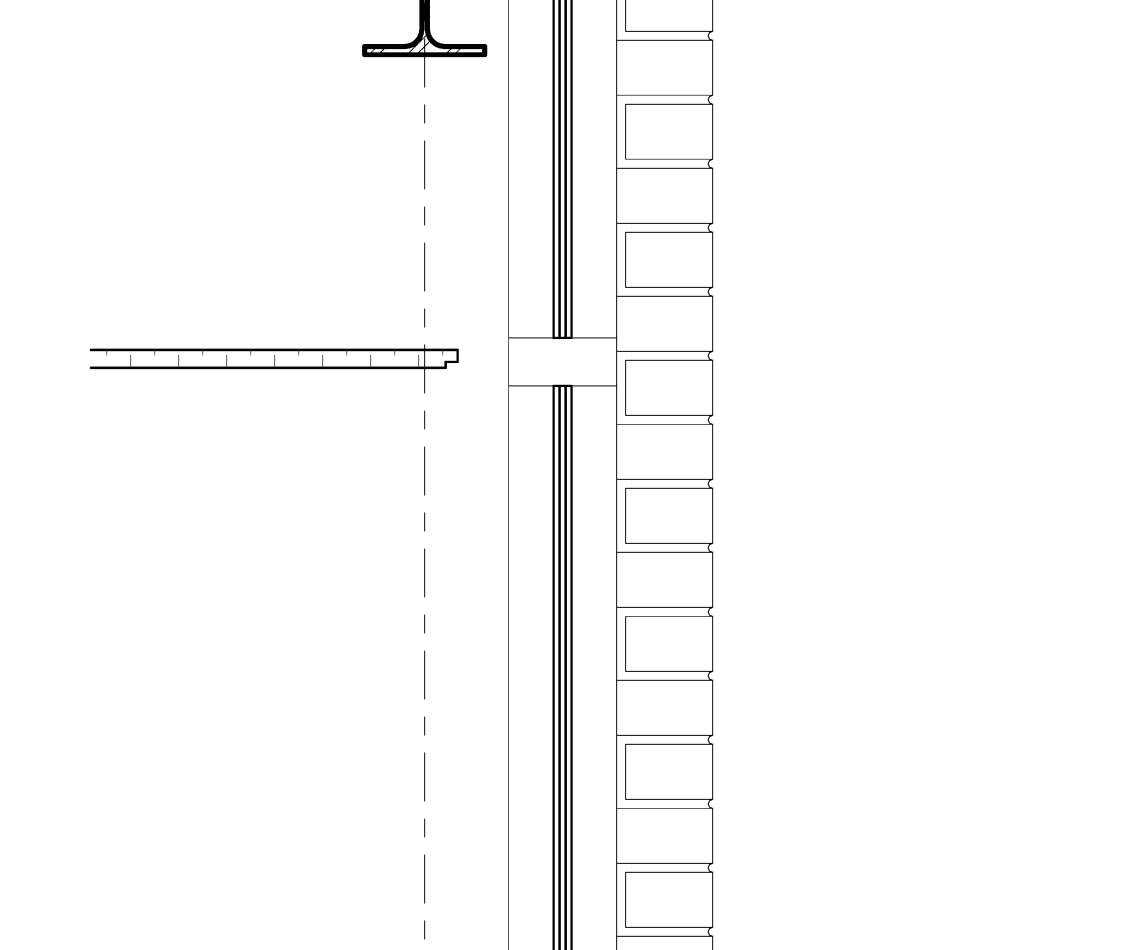

C4 STOREFRONT DETAIL AT ROOF EDGE
SCALE: 1 1/2" = 1'-0"

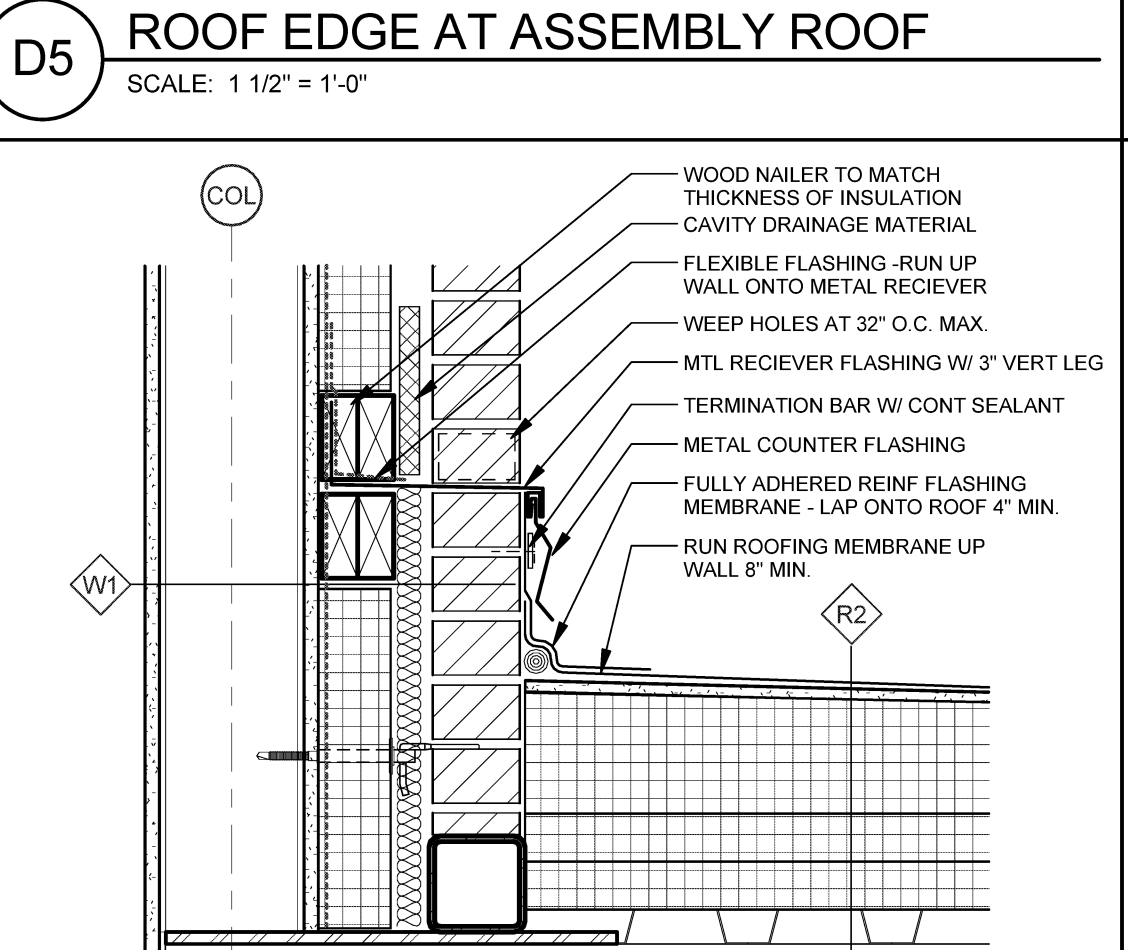

C5 EXTERIOR DETAIL
SCALE: 1 1/2" = 1'-0"

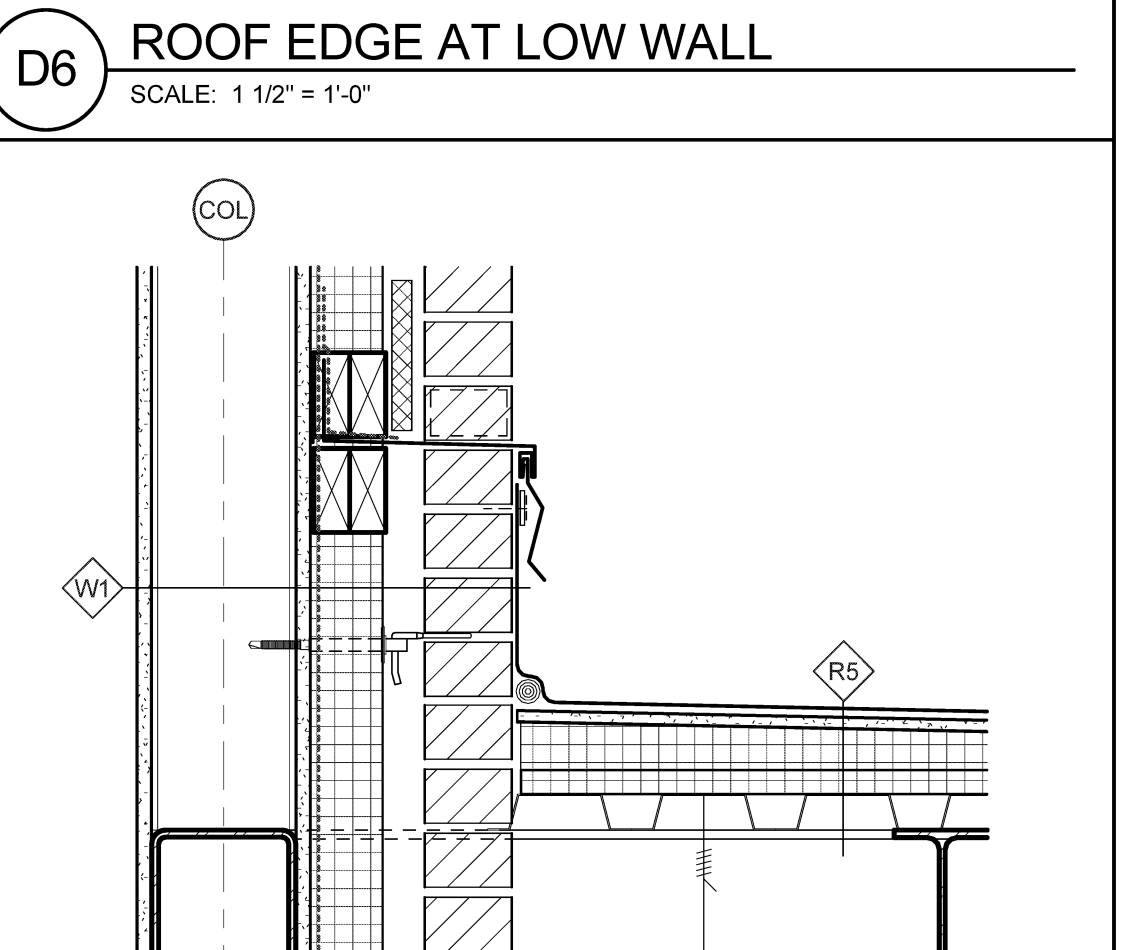

C6 FLASHING DETAIL
SCALE: 1 1/2" = 1'-0"

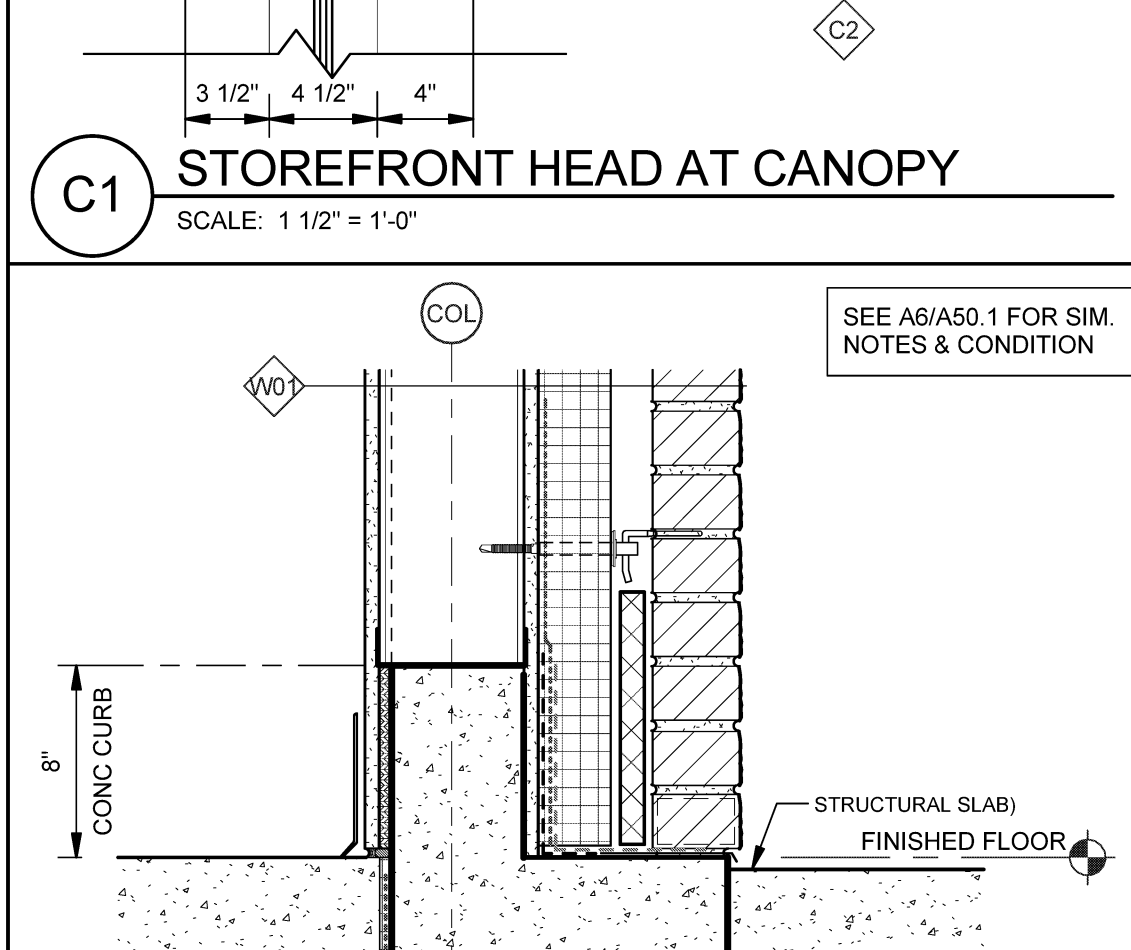

B1 FOUNDATION DTL - STRUCTURAL SLAB
SCALE: 1 1/2" = 1'-0"

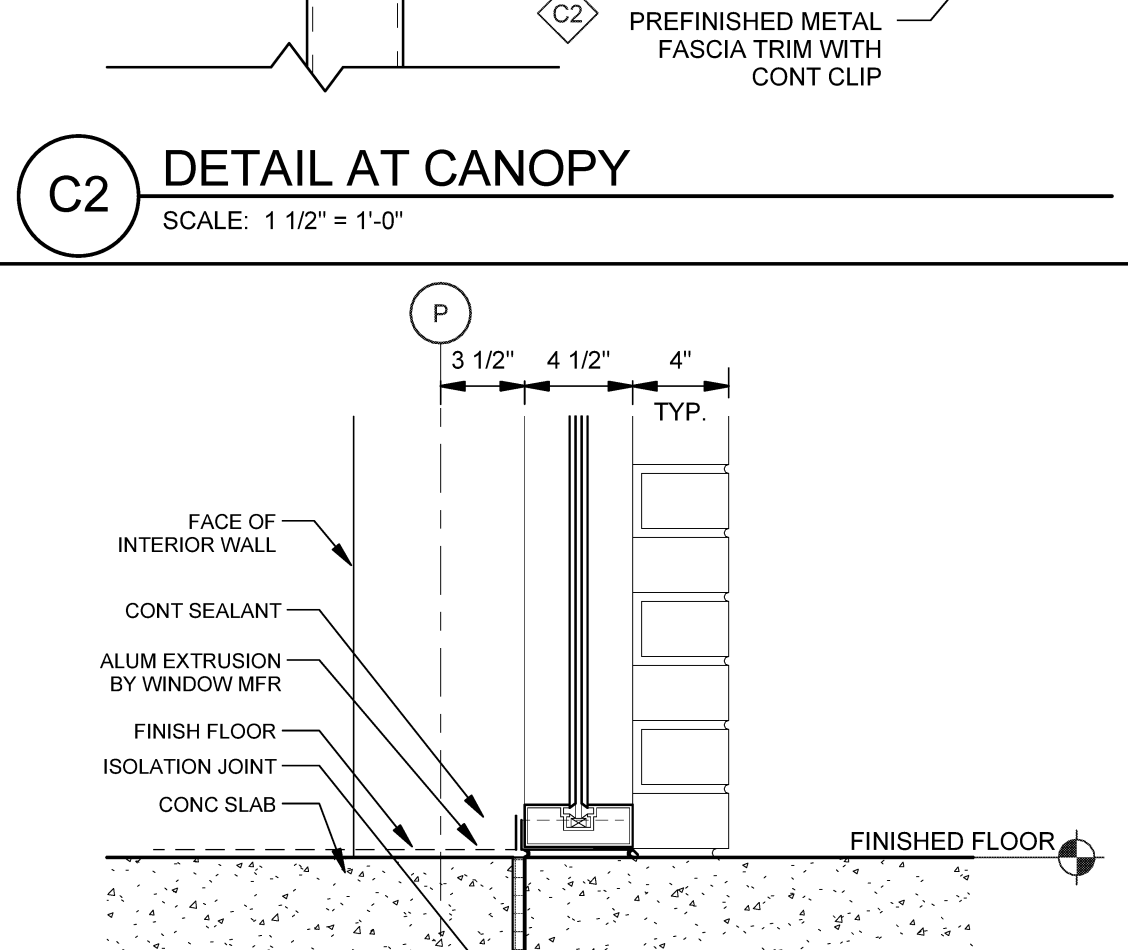

B2 FOUNDATION DTL AT STOREFRONT
SCALE: 1 1/2" = 1'-0"

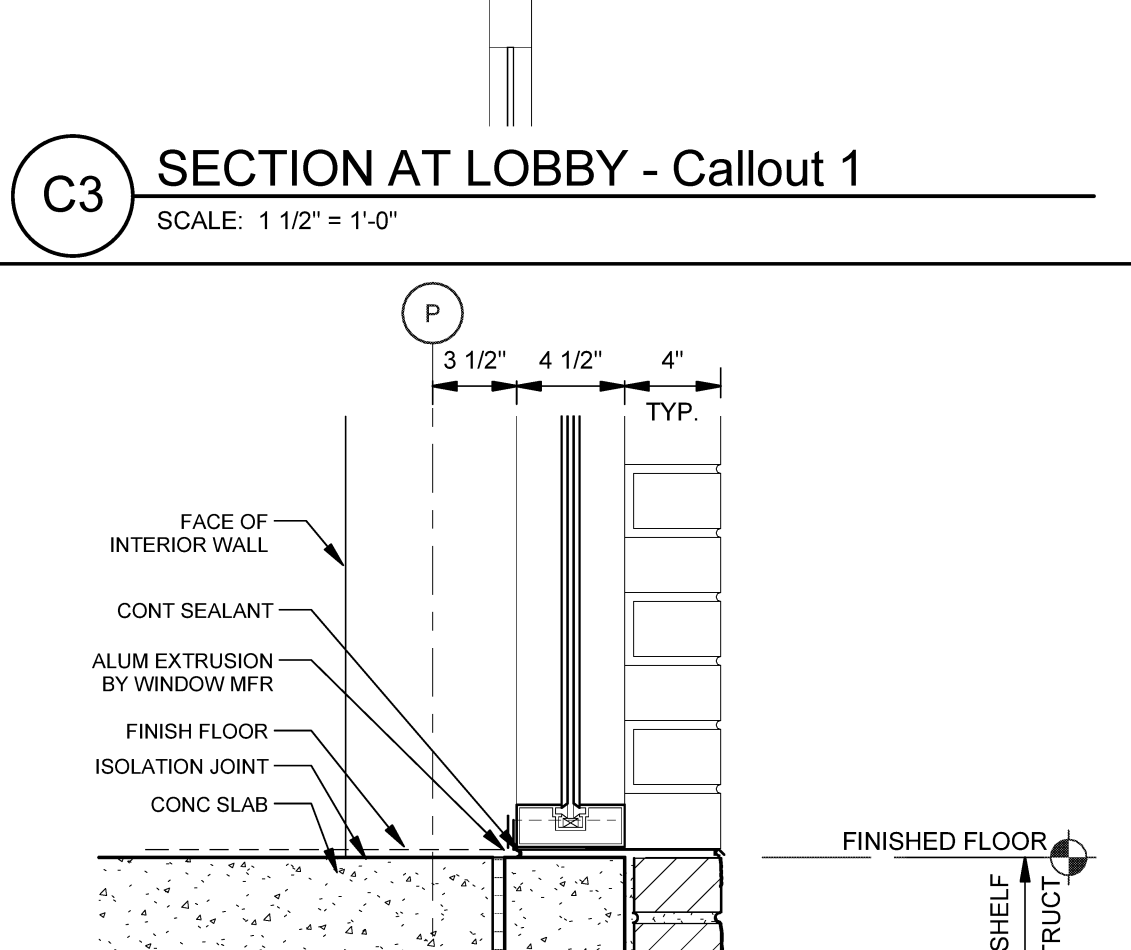

B3 FOUNDATION DTL AT STOREFRONT
SCALE: 1 1/2" = 1'-0"

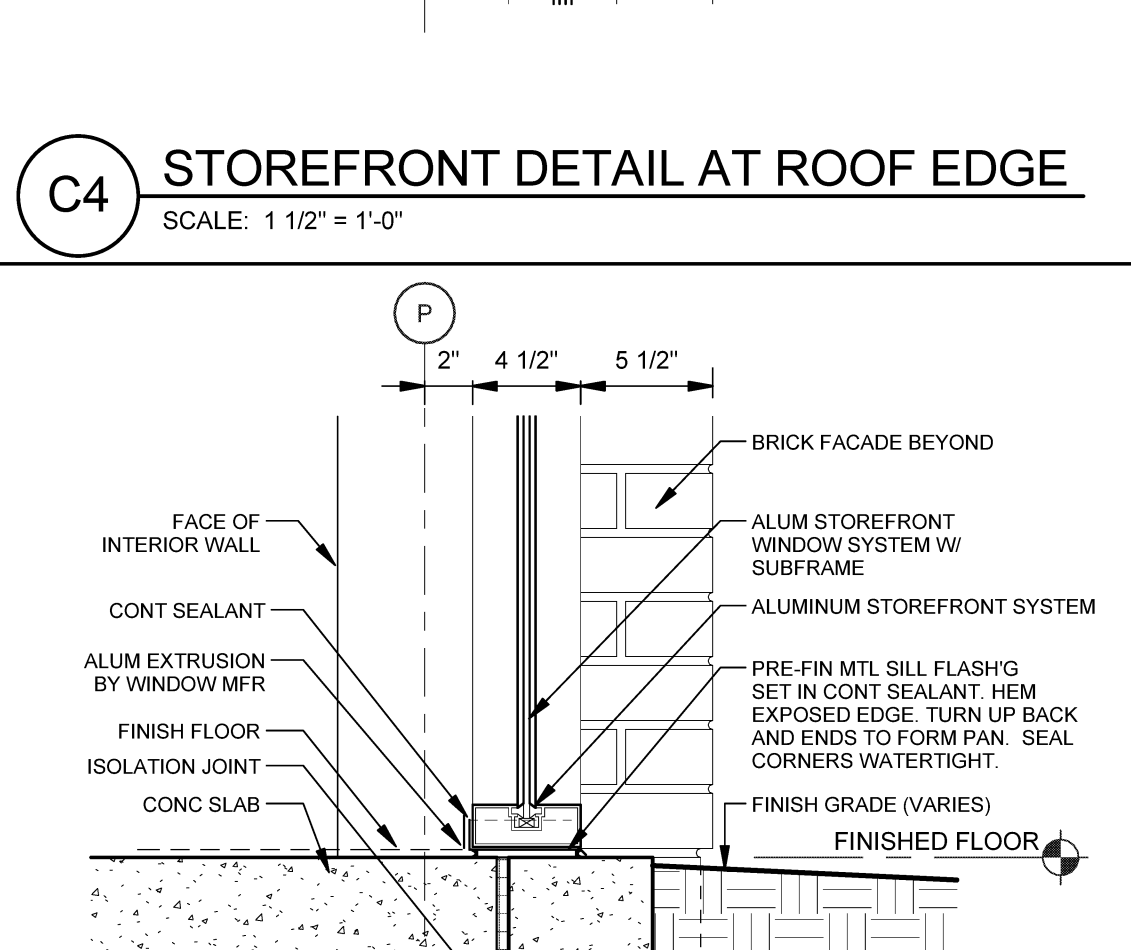

B4 FOUNDATION DTL AT STOREFRONT
SCALE: 1 1/2" = 1'-0"

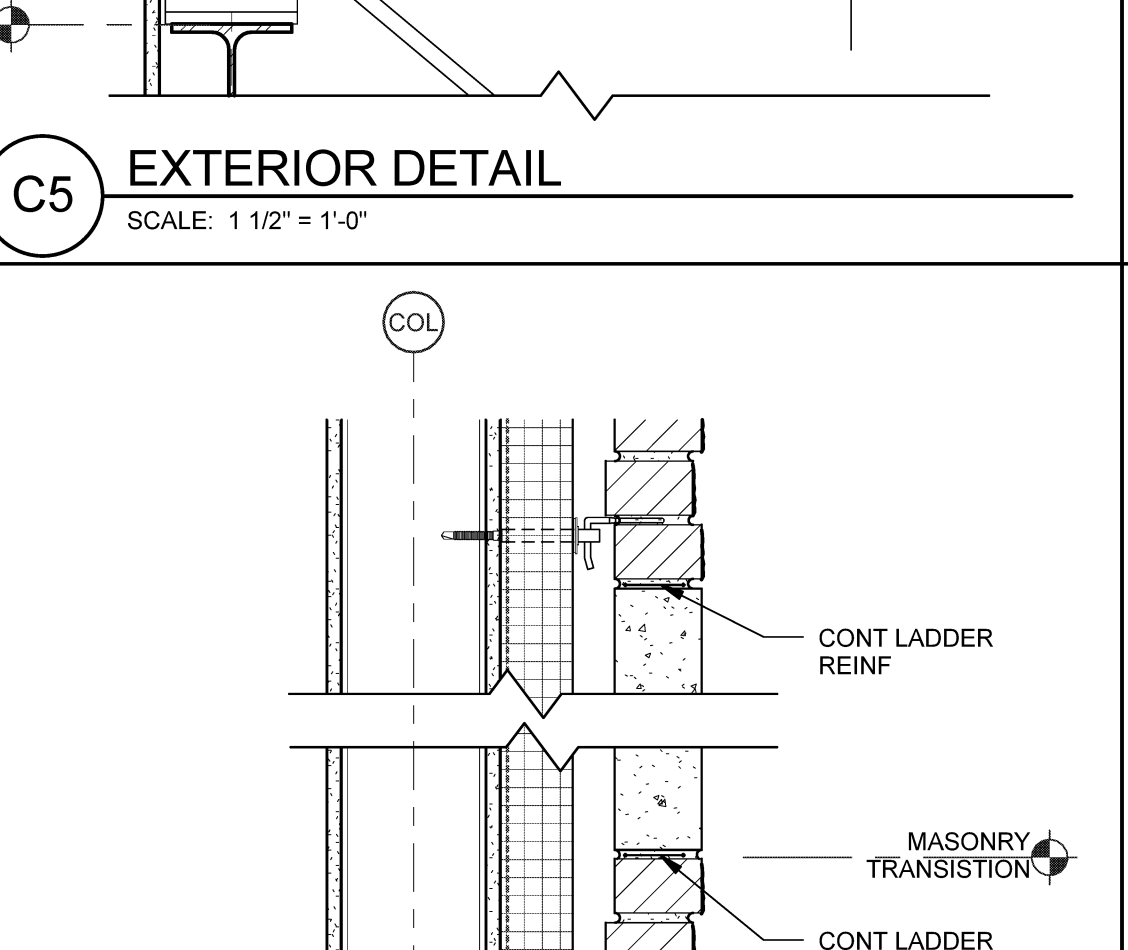

B5 DETAIL - BRICK TO PANEL TRANSITION
SCALE: 1 1/2" = 1'-0"

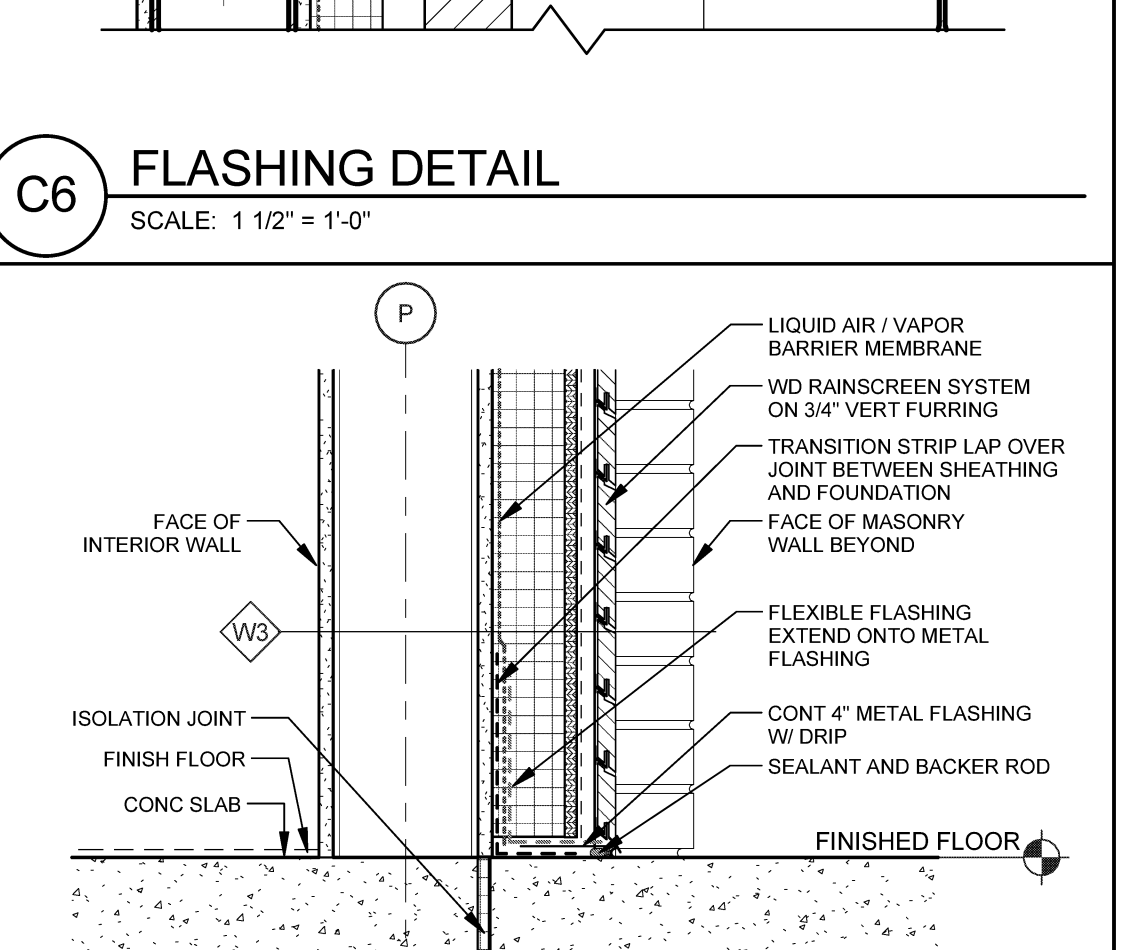

B6 FND DTL AT WD SIDING / STRUCT SLAB
SCALE: 1 1/2" = 1'-0"

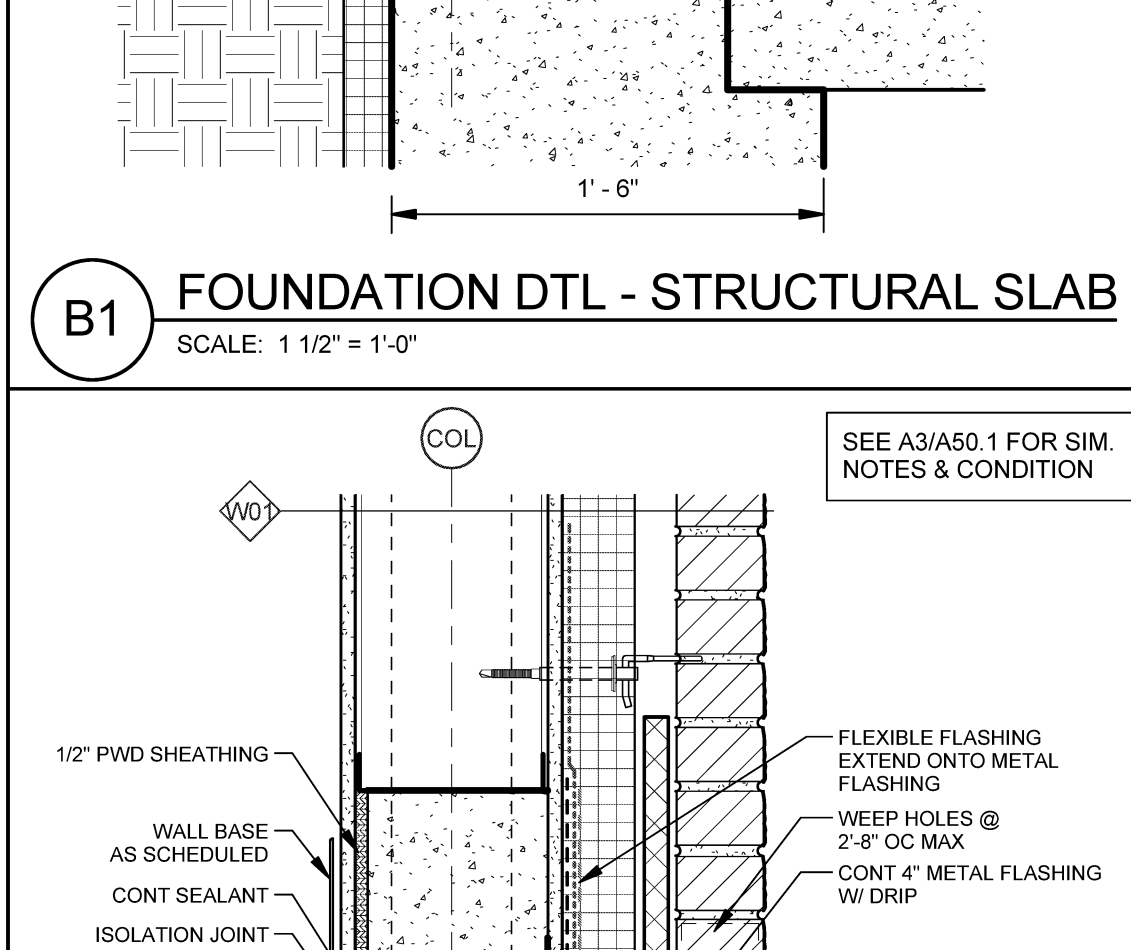

A1 FND DTL 8" SS BACKUP - SHELF
SCALE: 1 1/2" = 1'-0"

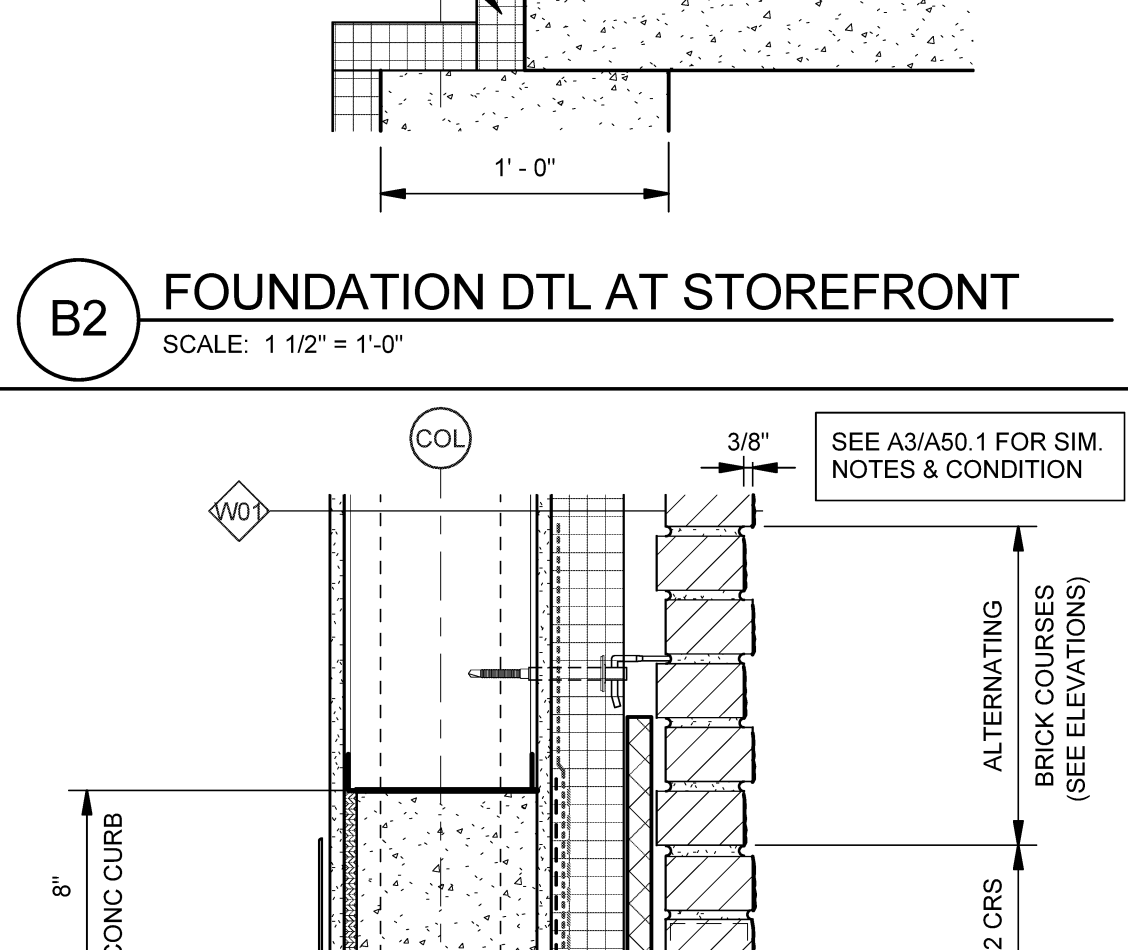

A2 FND DTL 8" SS BACKUP - ALTERNATING
SCALE: 1 1/2" = 1'-0"

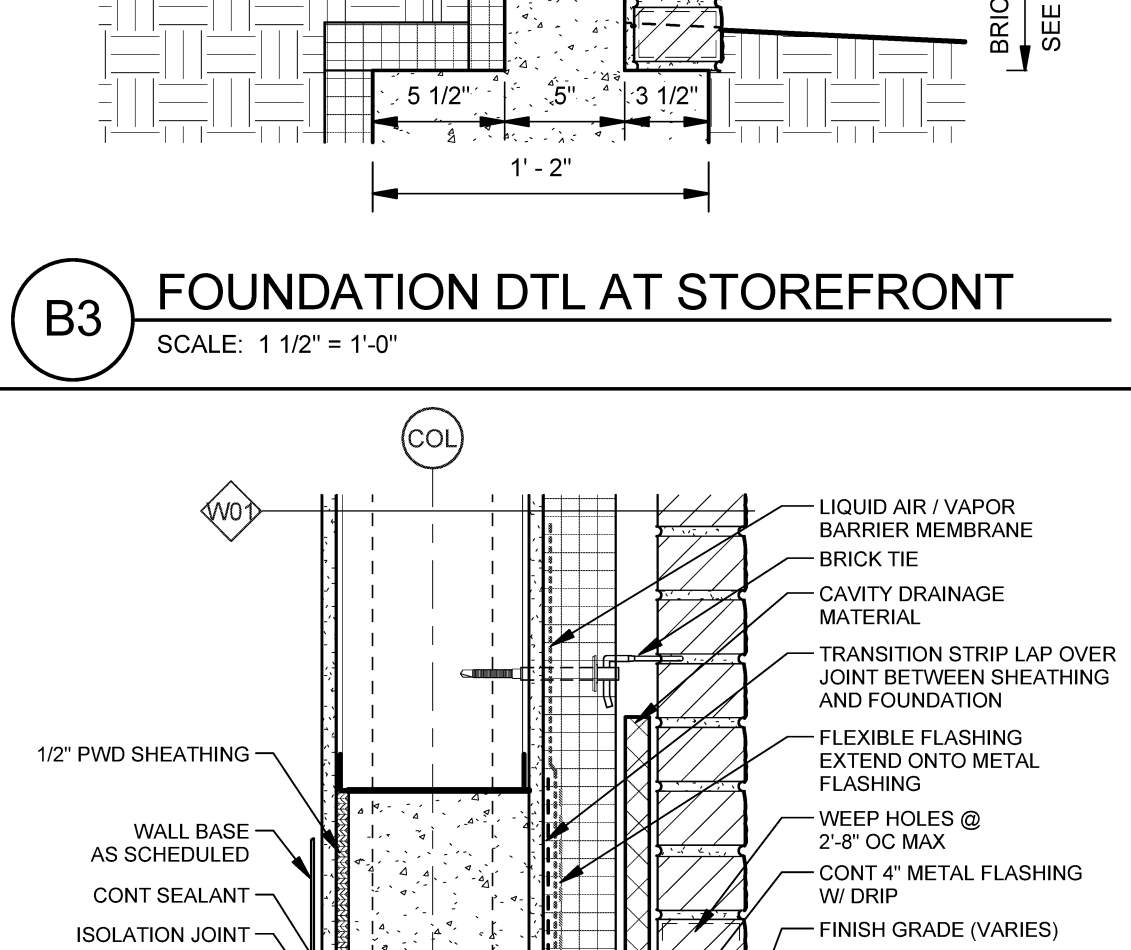

A3 FOUNDATION DETAIL 8" SS BACKUP
SCALE: 1 1/2" = 1'-0"

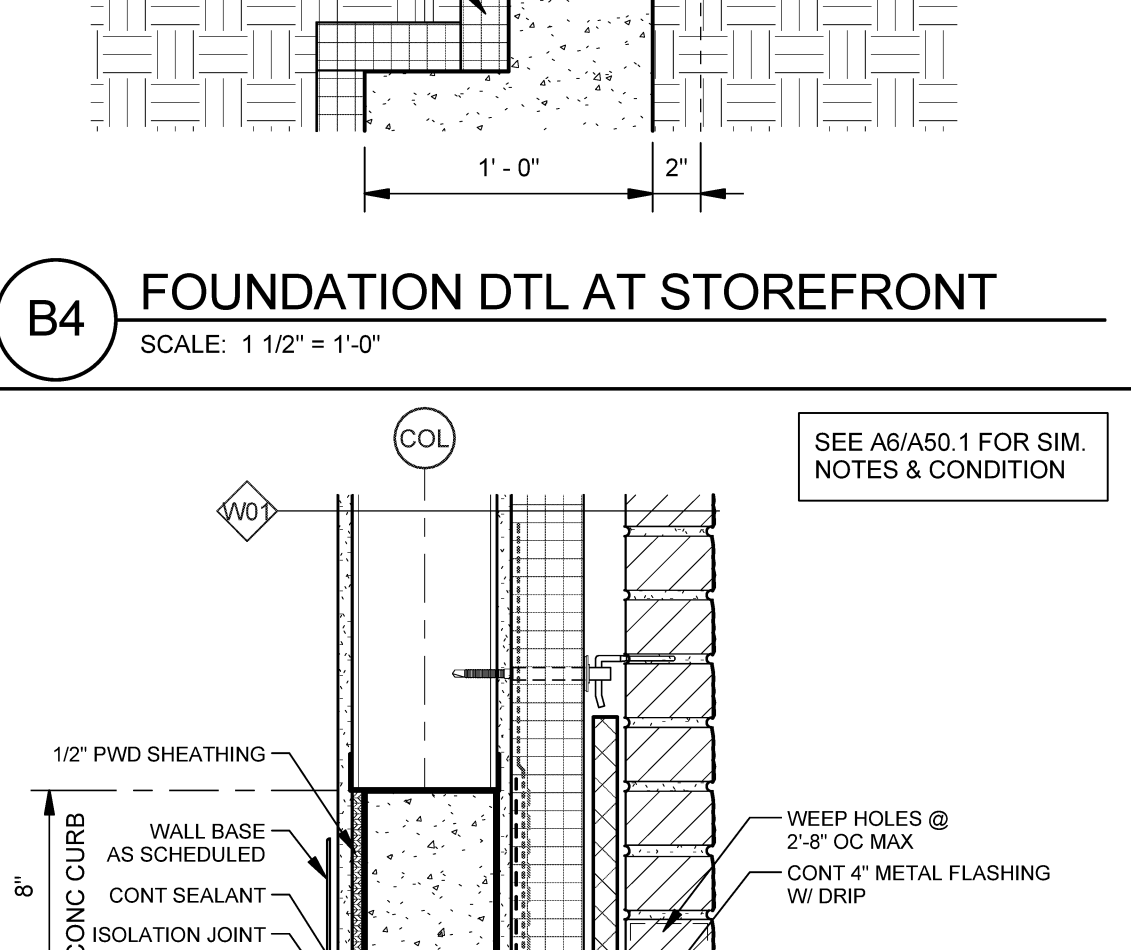

A4 FND DTL 6" SS BACKUP - SHELF
SCALE: 1 1/2" = 1'-0"

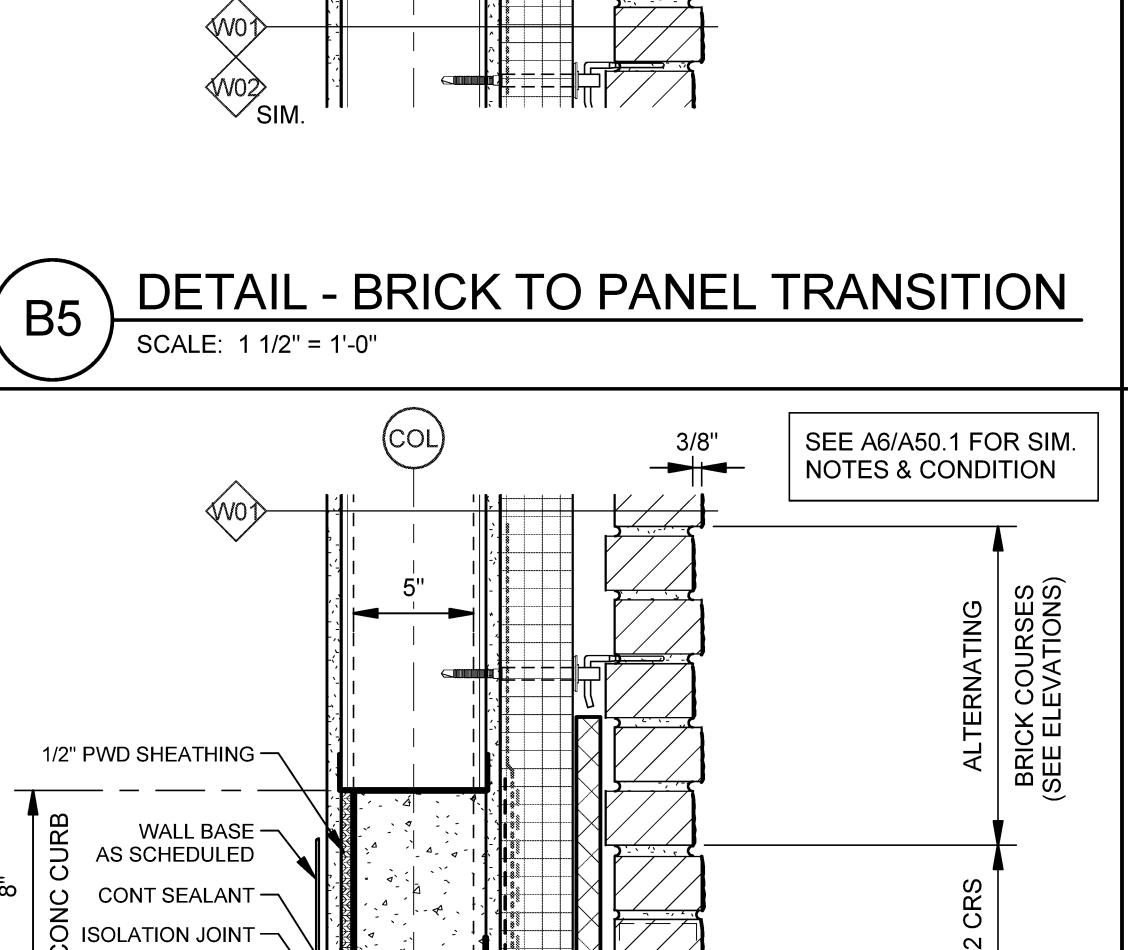

A5 FND DTL 6" SS BACKUP - ALTERNATING
SCALE: 1 1/2" = 1'-0"

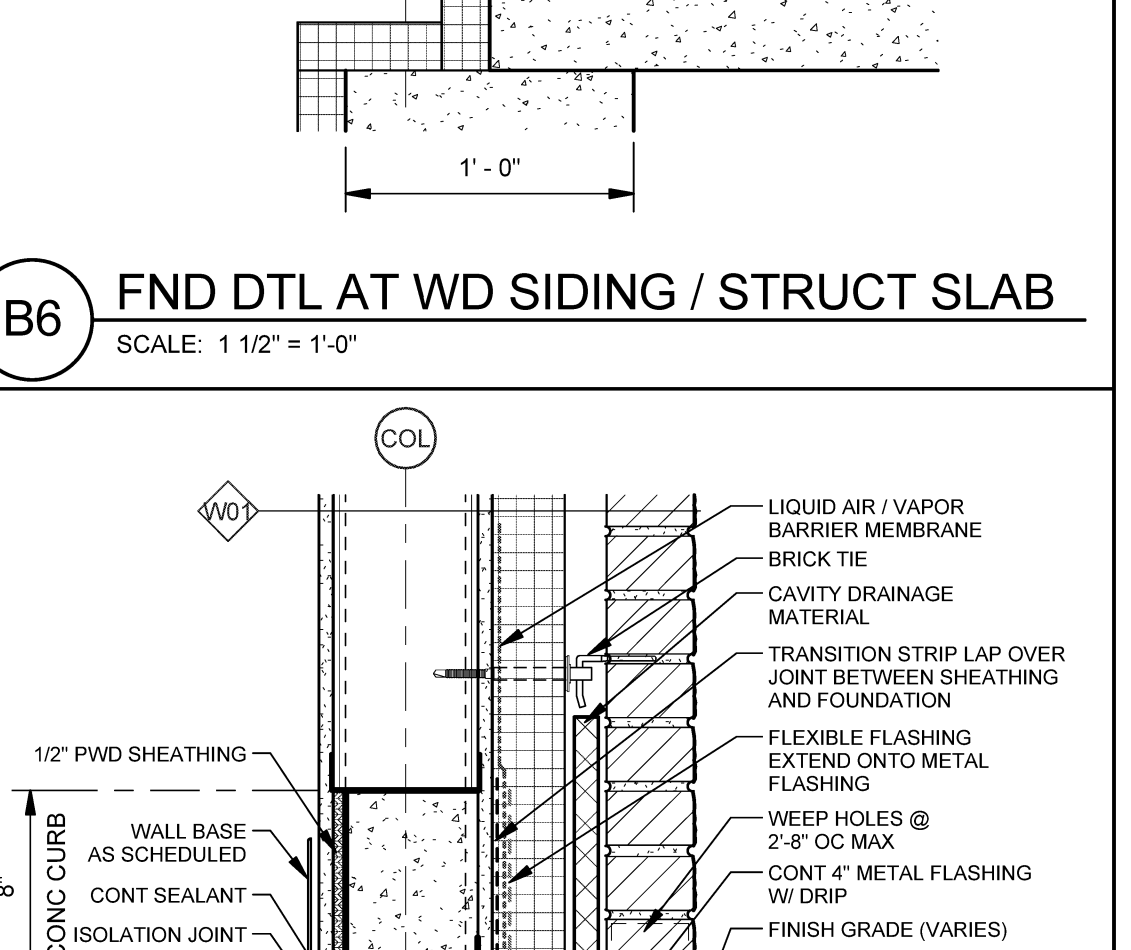

A6 FOUNDATION DETAIL 6" SS BACKUP
SCALE: 1 1/2" = 1'-0"

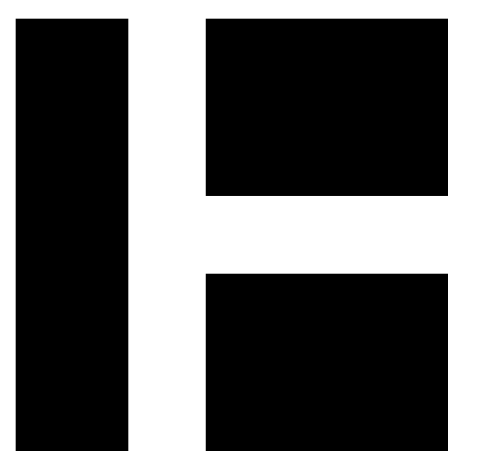

HARRIMAN

AUBURN PORTLAND MANCHESTER

JEWISH COMMUNITY ALLIANCE OF SOUTHERN MAINE

PORTLAND, ME

Harriman Project No. 15309

Key Plan

Proj North

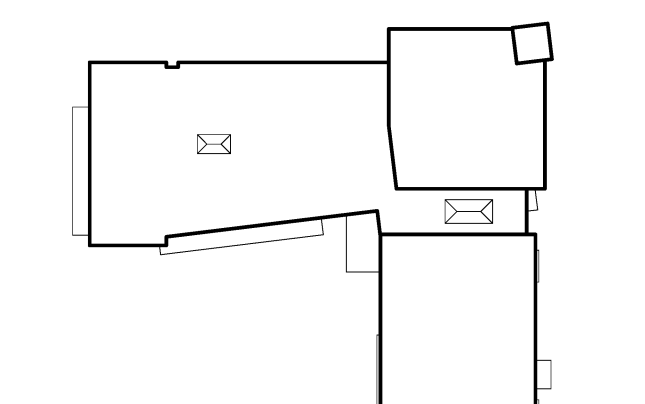

Issues and Revisions

Mark Date Description

03-25-16 CONSTRUCTION DOCUMENTS

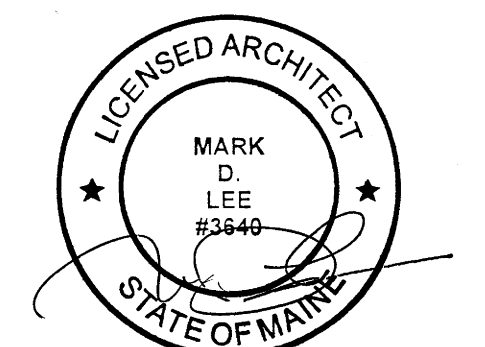

Drawing Scales

As indicated

PA/PE: Designer © 2016 Harriman Associates

Drawn By: Author

A50.1