



# **LEVEL I SITE ALTERATION & CONDITIONAL USE APPLICATIONS**

To:

**City of Portland**

For:

**Parking Lot Expansion  
53 Sewall Street, Portland, Maine**

Prepared for:

Eyecare Medical Group  
53 Sewall Street  
Portland, Maine 04102

Prepared by:

Sebago Technics, Inc.  
75 John Roberts Road, Suite 1A  
South Portland, Maine 04106

November 2014



November 12, 2014  
06267

Ms. Barbara Barhydt  
Development Review Services Manager  
City of Portland  
389 Congress Street  
Portland, ME 04101

**Application for Level I – Site Plan and Conditional Use Permits**  
**Proposed Parking Lot Expansion**

Dear Ms. Barhydt:

On behalf of the Eyecare Medical Group, we have prepared this application for Level I – Site Plan and Conditional Use Permit approval in the Small Residential (R-5) and Residential Professional (RP) Zones. The application is for a proposed parking lot expansion at the Eyecare Medical Group, located at 53 Sewall Street in Portland, ME. Small Residential (R-5) zoning standards require Conditional Use approval for off-street parking.

Proposed improvements include the construction of twenty-three (23) new parking spaces, associated ditching, one light pole, and an underdrained soil filter. On November 29<sup>th</sup>, 2006 the Portland Planning Authority granted minor Site Plan and Conditional Use approval for the construction of a similar parking lot immediately adjacent to the proposed parking lot expansion. The proposed parking lot will be constructed in a similar manner to mainly serve employees. A lease agreement from Central Maine Power Company to Eyecare Medical Group was initiated for the subject lease area, which was identified by both parties to be a suitable location for this type of project.

The project parcel is in the City's R-5 Small Residential Zone that is intended to achieve an attractive and comfortable neighborhood environment identified in the City's Comprehensive Plan. Areas surrounding the parcel are mainly residential with exception to the Residential Professional (R-P) Zone that borders the site to the east which includes the existing Eye Care Medical Group building. Overall, 5,526 s.f. of new pavement surface and 4,948 s.f. of new landscaped area will be created, for a total of 10,474 s.f. of disturbed area.

**Parking Demand**

The need for expanding the parking capacity stems from operational growth and corresponding demand at the project site. Currently, when parking is unavailable in designated off-street parking areas, Eyecare Medical Group employees and patients park in undesignated parking

areas along Hooper Street and within portions of the existing CMP owned area proposed for development. The CMP owned land contains gravel areas that previously served as a material storage and laydown area for the building expansion project in 2013. Currently the laydown area is serving as a vital parking area for employees since onsite parking is at capacity. The proposed 23-space parking lot will provide additional parking for employees.

#### **Stormwater Management Plan:**

We have prepared a post development stormwater inspection and maintenance plan which is enclosed. The paved parking area will be graded to convey surface runoff southwesterly across the parking area as sheet flow to an underdrained soil filter. The proposed stormwater management design exceeds Maine DEP Chapter 500 General Standard for treatment requirements. 100.0% of the surface runoff from impervious areas and roughly 98.0% of surface runoff from developed areas (impervious and landscaped areas) will be collected within the underdrained soil filter that is designed to provide temporary flood control as well as water quality treatment, stormwater cooling, and downstream channel protection. Also, please note that with the removal of an existing underdrained soil filter, the proposed soil filter is sized to treat and detain runoff from the parking area constructed in 2006.

#### **Compact Parking & Bicycle Parking:**

The parking lot expansion will include eleven compact spaces. Considering the amount existing parking spaces (83) for the facility and the additional parking spaces as proposed, approximately 20.19% of parking will be compact. The end result is a right-sized parking lot to meet the current needs.

A bicycle rack was installed as part of the 2013 building expansion project. Two Dero bike racks were installed with the capacity for four bicycles.

#### **Landscaping:**

Landscaping is currently provided as part of the adjacent parking areas and medical facility. Due to the project location, we have not proposed any site landscaping since the new parking expansion will be located behind the existing medical facility and is bounded by existing parking to the north and east, wooded areas to the west and CMP owned land to the south. The proposed parking layout will protect existing landscaping.

#### **Waivers:**

We respectfully request a waiver from a Preliminary Landscape Plan in accordance with Section 4 of the Technical Manual. We also request a relaxation of the standard for compact parking (Section 1.14 of Technical Manual) and lane width requirements (Details I-27 and I-29 of Technical Manual) because the proposed parking lot will be a low turnover lot that primarily serves employees. Generally, one way traffic will be promoted with employees parking in the

morning and leaving in the afternoon. The percentage of compact parking spaces (20.19%) slightly exceeds the 20.0% standard.

**Closure:**

On behalf of Eyecare Medical Group, we look forward to working with the staff to permit this project. As you consider the application, please contact us if you have any questions.

Sincerely,

SEBAGO TECHNICS, INC.

A handwritten signature in cursive script that reads "Craig Burgess".

Craig A. Burgess, P.E.  
Project Engineer

CAB/llg  
Enc.

# Table of Contents

---

Exhibit 1	Application Form (Level 1 Site Alteration)
Exhibit 2	Application Form (Conditional Use)
Exhibit 3	USGS Location Map
Exhibit 4	City Assessor's Map
Exhibit 5	Right, Title or Interest
Exhibit 6	Stormwater Management Report, Inspection, Maintenance and Housekeeping Plan & Stormwater Calculations
Exhibit 7	Lighting Specifications

# **Exhibit 1**

---

## **Application Form (Level 1 Site Alteration)**



Jeff Levine, AICP, Director  
Planning & Urban Development Department

**Electronic Signature and Fee Payment Confirmation**

Notice: Your electronic signature is considered a legal signature per state law.

By digitally signing the attached document(s), you are signifying your understanding this is a legal document and your electronic signature is considered a **legal signature** per Maine state law. You are also signifying your intent on paying your fees by the opportunities below.

I, the undersigned, intend and acknowledge that no Site Plan or Historic Preservation Applications can be reviewed until payment of appropriate application fees are **paid in full** to the Inspections Office, City of Portland Maine by method noted below:

- Within 24-48 hours, once my complete application and corresponding paperwork has been electronically delivered, I intend to **call the Inspections Office** at 207-874-8703 and speak to an administrative representative and provide a credit/debit card over the phone.
- Within 24-48 hours, once my application and corresponding paperwork has been electronically delivered, I intend to **call the Inspections Office** at 207-874-8703 and speak to an administrative representative and provide a credit/debit card over the phone.
- I intend to deliver a payment method through the U.S. Postal Service mail once my application paperwork has been electronically delivered.

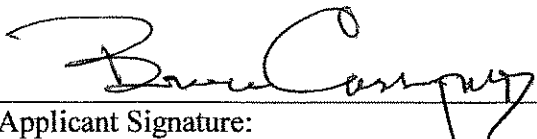
  
Applicant Signature:

11/12/14  
Date:

I have provided digital copies and sent them on:

Date:

**NOTE:** All electronic paperwork must be delivered to [buildinginspections@portlandmaine.gov](mailto:buildinginspections@portlandmaine.gov) or by physical means i.e. a thumb drive or CD to the Inspections Office, City Hall, 3<sup>rd</sup> Floor, Room 315.



## Level I – Site Alteration Development Review Application Portland, Maine

Planning and Urban Development Department  
Planning Division

Portland's Planning and Urban Development Department coordinates the development review process for site plan, subdivision and other applications under the City's Land Use Code. Attached is the application form for a Level I: Site Alterations. Please note that Portland has delegated review from the State of Maine for reviews under the Site Location of Development Act, Chapter 500 Stormwater Permits, and Traffic Movement Permits.

### Level I: Site Alteration Development includes:

- Alteration of a watercourse or wetland as defined in Section 14-47 of the City Code.
- Alteration of a site. The disturbance of land areas of less than one (1) acre that are stripped, graded, grubbed, filled or excavated. The Planning Authority shall exempt from review the loam and seeding of lawns and the cumulative placement of less than fifteen (15) cubic yards of fill on any lot provided such loaming or placement does not alter a drainage course, swale, wetland or redirect water onto adjoining property and does not violate any other provision of the Portland City Code or state or federal law. "Disturbed area" does not include routine maintenance, but does include re-development and new impervious areas.
- The construction of any temporary or permanent parking area, paving of existing unpaved surface parking areas between 1,000 and 7,500 sq. ft., or creation of other impervious surface areas between 1,000 and 7,500 sq. ft.
- The rehabilitation or reconstruction, but not new construction, of piers, docks, wharves, bridges, retaining walls, and other structures located within the shoreland zone.
- A site alteration in which vehicle access is proposed from more than one (1) street.

Portland's development review process and requirements are outlined in the Land Use Code (Chapter 14) which is available on our website:

Land Use Code: <http://me-portland.civicplus.com/DocumentCenter/Home/View/1080>

Design Manual: <http://me-portland.civicplus.com/DocumentCenter/View/2355>

Technical Manual: <http://me-portland.civicplus.com/DocumentCenter/View/2356>

#### **Planning Division**

Fourth Floor, City Hall  
389 Congress Street  
(207) 874-8719

#### **Office Hours**

Monday thru Friday  
8:00 a.m. – 4:30 p.m.



**PROJECT NAME:** Parking lot expansion, Eyecare Medical Group

**PROPOSED DEVELOPMENT ADDRESS:**

53 Sewall Street, Portland, ME 04102-2692

**PROJECT DESCRIPTION:**

Proposed off street parking area that will create 13 standard (9'x18') parking spaces and  
10 compact (8'x15') parking spaces.

**CHART/BLOCK/LOT:** Map 190, Block H, Lots 24, 25, 26, 27

**CONTACT INFORMATION:**

<b>Applicant – must be owner, Lessee or Buyer</b> Name: Eyecare Medical Group, attn: Terry Wogan Business Name, if applicable: Eyecare Medical Group Address: 53 Sewall Street City/State : Portland, ME      Zip Code: 04102-2692	<b>Applicant Contact Information</b> Work # (207) 828-2020 Home# N/A Cell # N/A      Fax# (207) 773-7034 e-mail: twogen@eyecaremed.com
<b>Owner – (if different from Applicant)</b> Name: Central Maine Power Company Address: 70 Farm View Drive City/State : New Gloucester, ME      Zip Code: 04260	<b>Owner Contact Information</b> Work # (207) 623-3521 Home# Cell #      Fax# e-mail:
<b>Agent/ Representative Name:</b> Sebago Technics, Inc. attn: Craig Burgess, PE Address: 75 John Roberts Road, Suite 1A City/State : South Portland, ME      Zip Code: 04106-6963	<b>Agent/Representative Contact information</b> Work # (207) 200-2073 Cell # (207) 837-1092 e-mail: cburgess@sebagotechnics.com
<b>Billing Information Name:</b> Eyecare Medical Group, attn: Terry Wogan Address: 53 Sewall Street City/State : Portland, ME      Zip Code: 04102-2692	<b>Billing Information</b> Work # (207) 828-2020 Cell # N/A      Fax# (207) 773-7034 e-mail: twogen@eyecaremed.com

<b>Engineer</b> Name: *see agent/representative Address: City/State :                      Zip Code:	<b>Engineer Contact Information</b> Work #    see agent/representative Cell #                              Fax# e-mail:
<b>Surveyor</b> Name: *see agent/representative Address: City/State :                      Zip Code:	<b>Surveyor Contact Information</b> Work #    see agent/representative Cell #                              Fax# e-mail:
<b>Architect</b> Name: N/A Address: City/State :                      Zip Code:	<b>Architect Contact Information</b> Work #    N/A Cell #                              Fax# e-mail:
<b>Attorney</b> Name: N/A Address: City/State :                      Zip Code:	<b>Attorney Contact Information</b> Work #    N/A Cell #                              Fax# e-mail:

**APPLICATION FEES:**

**(Payment may be made by Credit Card, Cash or Check payable to the City of Portland.)**

<input checked="" type="checkbox"/> Level 1 Site Alteration (\$200.00)	The City invoices separately for the following: <ul style="list-style-type: none"> <li>• Notices (\$.75 each)</li> <li>• Legal Ad (% of total Ad)</li> <li>• Planning Review (\$40.00 hour)</li> <li>• Legal Review (\$75.00 hour)</li> </ul> Third party review fees are assessed separately. Any outside reviews or analysis requested from the Applicant as part of the development review, are the responsibility of the Applicant and are separate from any application or invoice fees.
--	---

**APPLICATION SUBMISSION:**

1. All site plans and written application materials must be submitted electronically on a CD or thumb drive with each plan submitted as separate files, with individual file which can be found on the **Electronic Plan and Document Submittal** page of the City's website at <http://me-portland.civicplus.com/764/Electronic-Plan-and-Document-Submittal>
2. In addition, one (1) paper set of the plans (full size), one (1) paper set of plans (11 x 17), paper copy of written materials, and the application fee must be submitted to the Building Inspections Office to start the review process.

The application must be complete, including but not limited to the contact information, project data, application checklists, wastewater capacity, plan for fire department review, and applicant signature. The submissions shall include one (1) paper packet with folded plans containing the following materials:

1. One (1) full size site plans that must be folded.
2. One (1) copy of all written materials or as follows, unless otherwise noted:
  - a. Application form that is completed and signed.
  - b. Cover letter stating the nature of the project.
  - c. All Written Submittals (Sec. 14-527 (c), including evidence of right, title and interest.
3. A stamped standard boundary survey prepared by a registered land surveyor at a scale not less than one inch to 50 feet.
4. Plans and maps based upon the boundary survey and containing the information found in the attached sample plan checklist.
5. One (1) set of plans reduced to 11 x 17.

Please refer to the application checklist (attached) for a detailed list of submission requirements.

**APPLICANT SIGNATURE:**

I hereby certify that I am the Owner of record of the named property, or that the owner of record authorizes the proposed work and that I have been authorized by the owner to make this application as his/her authorized agent. I agree to conform to all applicable laws of this jurisdiction. In addition, if a permit for work described in this application is issued, I certify that the Planning Authority and Code Enforcement's authorized representative shall have the authority to enter all areas covered by this permit at any reasonable hour to enforce the provisions of the codes applicable to this permit.

This application is for a Level II Site Plan review. It is not a permit to begin construction. An approved site plan, a Performance Guarantee, Inspection Fee, Building Permit, and associated fees will be required prior to construction. Other Federal, State or local permits may be required prior to construction, which are the responsibility of the applicant to obtain.

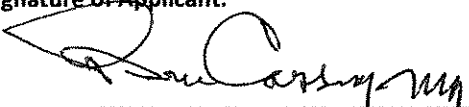
Signature of Applicant: 	Date: 4/12/14
--	------------------

## PROJECT DATA

The following information is required where applicable, in order to complete the application.

\*numbers in parenthesis denote lot #'s

<b>Total Area of Site</b>	10,010 (24,25) 9,409 (26,27) sq. ft.
<b>Proposed Total Disturbed Area of the Site</b>	2,232 (24,25) 8,242 (26,27) sq. ft.
If the proposed disturbance is greater than one acre, then the applicant shall apply for a Maine Construction General Permit (MCGP) with DEP and a Stormwater Management Permit, Chapter 500, with the City of Portland	
<b>Impervious Surface Area</b> (on lots 24, 25, 26, 27)	
Impervious Area (Total Existing)	5,655 (24,25) 0 (26,27) sq. ft.
Impervious Area (Total Proposed)	1,325 (24,25) 4,201 (26,27) sq. ft.
<b>Parking Spaces</b>	
# of Parking Spaces (Total Existing)	83 sq. ft.
# of Parking Spaces (Total Proposed)	23 sq. ft.
# of Handicapped Spaces (Total Proposed)	0 sq. ft.

<b>Level 1 Site Alteration</b>			
Applicant Checklist	Planner Checklist	# of Copies	<b>GENERAL WRITTEN SUBMISSIONS CHECKLIST</b>
X		1	Completed Application form
X		1	Application fees
X		1	Written description of project
X		1	Evidence of right, title and interest
X		1	Evidence of state and/or federal approvals, if applicable
X		1	Written assessment of proposed project's compliance with applicable zoning requirements
X		1	Summary of existing and/or proposed easement, covenants, public or private rights-of-way, or other burdens on the site
X		1	Written requests for waivers from site plan or technical standards, if applicable.
X		1	Evidence of financial and technical capacity
Applicant Checklist	Planner Checklist	# of Copies	<b>SITE PLAN SUBMISSIONS CHECKLIST</b>
X		1	Boundary Survey meeting the requirements of Section 13 of the City of Portland's Technical Manual
X		1	Preliminary Site Plan including the following: (information provided may be preliminary in nature during preliminary plan phase)
X			Proposed grading and contours;
X			Existing structures with distances from property line;
X			Proposed site layout and dimensions for all proposed structures (including piers, docks or wharves in Shoreland Zone), paved areas, and pedestrian and vehicle access ways;
X			Preliminary design of proposed stormwater management system in accordance with Section 5 of the Technical Manual (note that Portland has a separate applicability section);
X			Preliminary infrastructure improvements;
N/A			Preliminary Landscape Plan in accordance with Section 4 of the Technical Manual;

## Site Plan Standards for Review of Level I: Site Alteration

Level I: Site alteration plans shall only be subject to the following site plan standards, as applicable, as contained in section 14-526:

- (a) Transportation standards:
  1. Impact on surrounding street systems,
  2. Access and circulation, and
  4. Parking
- (b) Environmental quality standards
  1. Preservation of significant natural features,
  2. Landscaping and landscape preservation, and
  3. Water quality, stormwater management and erosion control.
- (c) Public infrastructure and community safety standards.
  1. Consistency with city master plans.
- (d) Site design standards
  5. Historic resources,
  6. Exterior lighting,
  8. Signage and wayfinding, and
  9. Zoning related design standards.

Except as provided in article III, or to conditions imposed under section 14-526(e) only, or to those submission requirements set forth in section 14-527 as relate solely thereto.



### PORTLAND FIRE DEPARTMENT SITE REVIEW FIRE DEPARTMENT CHECKLIST



A separate drawing[s] shall be provided to the Portland Fire Department for all site plan reviews.

1. Name, address, telephone number of applicant.
  2. Name address, telephone number of architect
  3. Proposed uses of any structures [NFPA and IBC classification]
  4. Square footage of all structures [total and per story]
  5. Elevation of all structures
  6. Proposed fire protection of all structures
- **As of September 16, 2010 all new construction of one and two family homes are required to be sprinkled in compliance with NFPA 13D. This is required by City Code. (NFPA 101 2009 ed.)**

7. Hydrant locations

# **Exhibit 2**

---

## **Application Form (Conditional Use)**



# Conditional Use for Planning Board Review Development Review Application Portland, Maine

Planning and Urban Development Department  
Planning Division

Portland's Planning and Urban Development Department coordinates the development review process for site plan, subdivision and other applications under the City's Land Use Code. Attached is the application form for a Conditional Use where the Planning Board is listed as the reviewing authority rather than the Zoning Board of Appeals. Please note that Portland has delegated review from the State of Maine for reviews under the Site Location of Development Act, Chapter 500 Stormwater Permits, and Traffic Movement Permits.

## **A. Conditional Use: Standards and Criteria – Section 14-474 and Zone Related Criteria**

Conditional uses are listed in the Zoning Ordinance for each zone and these proposed uses must address the criteria contained in Section 14-474 in the written application. In addition to the criteria in Section 14-474, each application must address any applicable conditional use standards contained in the applicable zone and the proposed specific use. The Zoning Ordinance specifies when the Planning Board is designated as the reviewing authority rather than the Zoning Board of Appeals. This application is for Planning Board reviews only.

Upon showing that a proposed use is a conditional use under this article, a conditional use permit shall be granted unless the Board determines that:

- a. The volume and type of vehicle traffic to be generated, hours of operation, expanse of pavement, and the number of parking spaces required are not substantially greater than would normally occur at surrounding uses or other allowable uses in the same zone; and
- b. The proposed use will not create unsanitary or harmful conditions by reason of noise, glare, dust, sewage disposal, emissions to the air, odor, lighting, or litter; and
- c. The design and operation of the proposed use, including but not limited to landscaping, screening, signs, loading, deliveries, trash or waste generation, arrangement of structures, and materials storage will not have a substantially greater effect/impact on surrounding properties than those associated with surrounding uses or other allowable uses in the zone.

## **B. Site Plan Application: Please submit the Conditional Use Application in addition to the applicable Site Plan Application.**

Portland's development review process and requirements are outlined in the Land Use Code (Chapter 14) which is available on our website:

Land Use Code: <http://me-portland.civicplus.com/DocumentCenter/Home/View/1080>

Design Manual: <http://me-portland.civicplus.com/DocumentCenter/View/2355>

Technical Manual: <http://me-portland.civicplus.com/DocumentCenter/View/2356>

**Planning Division**  
Fourth Floor, City Hall  
389 Congress Street  
(207) 874-8719

**Office Hours**  
Monday thru Friday  
8:00 a.m. – 4:30 p.m.



**PROJECT NAME:** Parking lot expansion, Eyecare Medical Group

**PROPOSED DEVELOPMENT ADDRESS:**

53 Sewall Street, Portland, ME 04102-2692

---

**ASSESSOR'S CHART/BLOCK/LOT (s):** Map 190, Block H, Lots 24, 25, 26, 27

**Applicable Zone:** RP, R-5

**CONTACT INFORMATION:**

<b>Applicant – must be owner, Lessee or Buyer</b> Name: Eyecare Medical Group, attn: Terry Wogan Business Name, if applicable: Eyecare Medical Group Address: 53 Sewall Street City/State : Portland, ME                      Zip Code: 04102-2692	<b>Applicant Contact Information</b> Work # (207) 828-2020 Home# N/A Cell # N/A                      Fax# (207) 773-7034 e-mail: twogen@eyecaremed.com
<b>Owner – (if different from Applicant)</b> Name: Central Maine Power Company, attn: Alice Richards Address: 70 Farm View Drive City/State : New Gloucester, ME   Zip Code: 04260	<b>Owner Contact Information</b> Work # (207) 626-9817 Home# Cell #                      Fax# e-mail:
<b>Billing Information</b> Name: Eyecare Medical Group, attn: Terry Wogan Address: 53 Sewall Street City/State : Portland, ME                      Zip Code: 04102-2692	<b>Billing Information</b> Work # (207) 828-2020 Cell # N/A                      Fax# (207) 773-7034 e-mail: twogen@eyecaremed.com

**RIGHT, TITLE OR INTEREST:**

See attached lease agreements

(Please identify the status provide documentary evidence, attached to this application, of the applicant's right, title, or interest in the subject property (ex: deed, option or contract to purchase or lease the property.)

**VICINITY MAP:** (Please attach a map showing the subject parcel and abutting parcels, labeled as to ownership and/or current use.)

**EXISTING USE:** Describe the existing use of the subject property.

Cleared gravel area previously used for material storage and laydown for building addition.

---

**PROPOSED USE:** Describe the proposed use of the subject property

Proposed off street parking area that will create 13 standard (9'x18') parking spaces and 10 compact (8'x15') parking spaces.

**TYPE OF CONDITIONAL USE PROPOSED (Refer To Specific Provisions Of Land Use Code Authorizing The Proposed Conditional Use).**

Off-street parking of passenger cars. Board of appeals may authorize parking in certain residential zones.

**SITE PLAN:** Submit a separate site plan application for the proposal that provides a site plan for the property, showing existing and proposed improvements, which meets the submission requirements of the applicable level of site plan review.

**CONDITIONAL USE STANDARDS AND CONDITIONS – 14-474**

Address the following criteria in your written application and any applicable conditional use standards contained in the zoning code for the specific use. Upon showing that a proposed use is a conditional use under this article, a conditional use permit shall be granted unless the Board determines that:

- a. The volume and type of vehicle traffic to be generated, hours of operation, expanse of pavement, and the number of parking spaces required are not substantially greater than would normally occur at surrounding uses or other allowable uses in the same zone; and
- b. The proposed use will not create unsanitary or harmful conditions by reason of noise, glare, dust, sewage disposal, emissions to the air, odor, lighting, or litter; and
- c. The design and operation of the proposed use, including but not limited to landscaping, screening, signs, loading, deliveries, trash or waste generation, arrangement of structures, and materials storage will not have a substantially greater effect/impact on surrounding properties than those associated with surrounding uses or other allowable uses in the zone.

**CONDITIONAL USE AUTHORIZED BY: SECTION 14- 118-C.1**

Address any specific conditional use standards for the specific use contained in the zoning code in the written submission.

**APPLICATION FEES:**

**(Payment may be made by Credit Card, Cash or Check payable to the City of Portland.)**

<p><input checked="" type="checkbox"/> Conditional Use Review (\$100.00)</p> <p>(Please submit a separate application for the applicable site plan review. Fees and charges are listed within the application)</p>	<p>The City invoices separately for the following:</p> <ul style="list-style-type: none"> <li>• Notices (\$.75 each)</li> <li>• Legal Ad (% of total Ad)</li> <li>• Planning Review (\$40.00 hour)</li> <li>• Legal Review (\$75.00 hour)</li> </ul> <p>Third party review fees are assessed separately. Any outside reviews or analysis requested from the Applicant as part of the development review, are the responsibility of the Applicant and are separate from any application or invoice fees.</p>
--	---

**APPLICATION SUBMISSION:**

1. All site plans and written application materials must be submitted electronically on a CD or thumb drive with each plan submitted as separate files, with individual file which can be found on the Electronic Plan and Document Submittal page of the City's website at <http://me-portland.civicplus.com/764/Electronic-Plan-and-Documents-Submittal>
2. In addition, one (1) paper set of the plans (full size), one (1) paper set of plans (11 x 17), paper copy of written materials, and the application fee must be submitted to the Building Inspections Office to start the review process.
3. The application must be complete, including but not limited to the contact information, project data, application checklists, wastewater capacity, plan for fire department review, and applicant signature. The submissions shall include one (1) paper packet with folded plans containing the following materials:
  1. One (1) full size site plans that must be folded.
  2. One (1) copy of all written materials or as follows, unless otherwise noted:

Applicant Checklist	Planner Checklist	# of Copies	
X		1	Application form that is completed and signed.
X		1	Cover letter stating the nature of the project.
X		1	Evidence of right, title and interest.
X		1	Written Submittals that address the conditional use standards of Sec. 14-474.
X		1	Written submittals that address any applicable standards of review contained in the zoning code for the specific use.
X		1	A stamped standard boundary survey prepared by a registered land surveyor at a scale not less than one inch to 50 feet and containing the information required for the applicable level of site plan review.
X		1	An accompanying site plan application, as applicable.

**APPLICANT SIGNATURE:**

I hereby certify that I am the Owner of record of the named property, or that the owner of record authorizes the proposed work and that I have been authorized by the owner to make this application as his/her authorized agent. I agree to conform to all applicable laws of this jurisdiction. In addition, if a permit for work described in this application is issued, I certify that the Planning Authority and Code Enforcement's authorized representative shall have the authority to enter all areas covered by this permit at any reasonable hour to enforce the provisions of the codes applicable to this permit.

**This application is for a Conditional Use Review. It is not a permit to begin construction. An approved site plan, a Performance Guarantee, Inspection Fee, Building Permit, and associated fees will be required prior to construction. Other Federal, State or local permits may be required prior to construction, which are the responsibility of the applicant to obtain.**

Signature of Applicant: 	Date: 01/12/17
--	-------------------

# **Exhibit 3**

---

## **USGS Location Map**



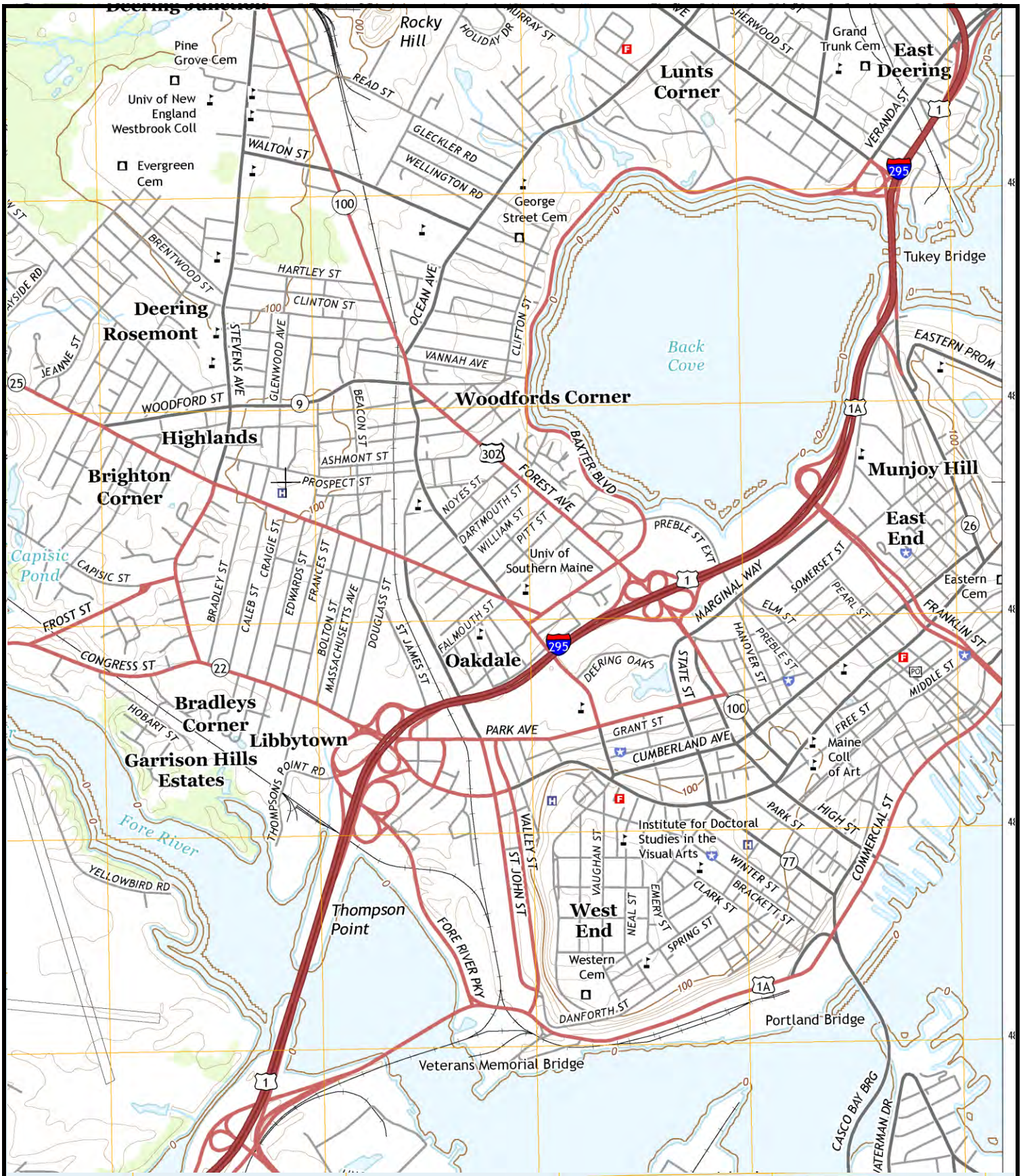

WWW.SE BAGOTECHNICS.COM  
 75 John Roberts Rd. - Suite 1A    250 Goddard Rd. - Suite B  
 South Portland, ME 04106    Lewiston, ME 04240  
 (207) 200-2100    (207) 783-5656

**SITE LOCATION MAP**  
**PROPOSED PARKING LOT EXPANSION**

LOCATION:  
 53 SEWALL STREET PORTLAND, ME

FOR:  
 EYE CARE MEDICAL GROUP

SCALE: 1"=2000'

DATE: 11/06/14

SHEET:  
 1 OF 1

# **Exhibit 4**

---

## **City Assesor's Map**



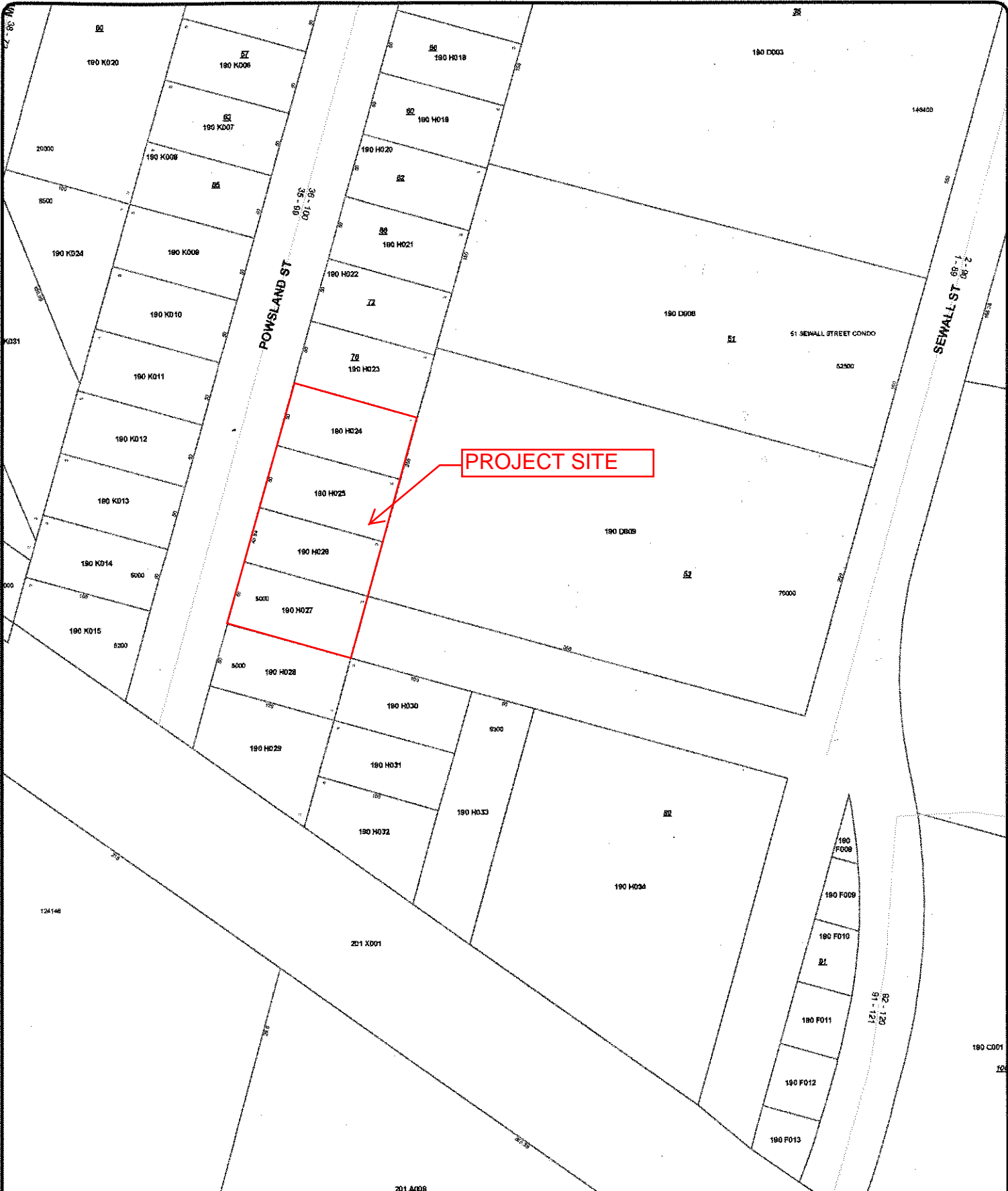

**PROJECT SITE**



75 John Roberts Rd. - Suite 1A South Portland, ME 04106  
 250 Goddard Rd. - Suite B Lewiston, ME 04240  
 Tel: 207-783-5456  
 www.sebagotechnics.com

**TAX MAP**  
 OF PROPOSED PARKING LOT EXPANSION

LOCATION:  
 EYECARE MEDICAL GROUP  
 53 SEWALL STREET, PORTLAND, ME 04102

FOR:  
 EYECARE MEDICAL GROUP  
 53 SEWALL STREET, PORTLAND, ME 04102

SCALE: 1" = 100'  
 DATE: 11-10-14  
 SHEET: 1 OF 1

# **Exhibit 5**

---

**Right, Title or Interest**



## LEASE AGREEMENT

**THIS LEASE** is effective this 9<sup>th</sup> day of Sept, 2013 by and between **Central Maine Power Company**, a Maine corporation having a place of business at 83 Edison Drive, Augusta, Maine 04336 (hereinafter called "Landlord"), and **Eyecare Medical Group** with a principal place of business at 53 Sewall Street, Portland, Maine 04102-2692 (hereinafter called "Tenant").

### Section One Premises

Landlord does hereby lease unto Tenant, and Tenant does hereby rent from Landlord, for the term and upon and subject to the terms and conditions set forth in this Lease, a certain lot or parcel of land situated on the westerly side of Hooper Street and adjacent to Landlord's Sewall Street Substation located in the City of Portland, Cumberland County, Maine being a portion of Landlord's property identified by the Portland Tax Assessor as Lots H026 and H027 of Map 190, and described as lots 73 and 74 in a deed from Myers and Mahoney Plumbing Company to Cumberland County Power and Light Company dated May 21, 1930 and recorded in the Cumberland County Registry of Deeds in Book 1347, Page 143. Said portion shown on Exhibit A (herein referred to as the "Premises") attached hereto and made a part hereof.

### Section Two Term

- (a) The Initial Term of this Lease shall be for a period of five (5) years commencing on September 9, 2013 and ending on September 8, 2018.
- (b) Provided that Tenant is not then in default, this Lease may be renewed, at Tenant's option, for two (2) renewal terms of five (5) years, exercisable by notice to the Landlord in writing delivered at least six (6) months before the commencement of each said renewal term. The terms and conditions of such renewal term shall be those provided in this Lease except that Tenant shall have no further right to extend beyond the expiration of said renewal term.

### Section Three Rent

Annual rent for the initial term of this Lease shall be Five Thousand Dollars (\$5,000) payable by the Tenant to the Landlord in quarterly payments of One Thousand Two Hundred Fifty Dollars (\$1,250.00) due in advance on the 1st day of January, April, July, October of each and every year. On the anniversary of the first quarterly payment due date which falls after the effective date of the initial term of this agreement and each year after that annual rent shall be increased 2% over the rent for the prior year.

**Section Four**  
**Rent to be Net to Landlord**

It is the intention of the parties that the rent payable shall be net to Landlord so that this Lease shall yield to Landlord the net rent specified herein, including any additional rent, during the term of this Lease, and that all costs, expenses and obligations of every kind and nature whatsoever relating to the Premises during the term of this Lease shall be paid by Tenant, including but not limited to maintenance, repair (including structural repairs), governmental assessments and taxes, utility charges and fines. Tenant shall not be entitled to any abatement, reduction, setoff, counterclaim, defense or deduction with respect to any basic rent, additional rent or other sum payable hereunder, except as specifically provided in the Sections entitled "Eminent Domain" and "Defaults" herein.

**Section Five**  
**Taxes and Utility Expenses**

(a) Tenant shall, during the term of this Lease, as additional rent, pay and discharge punctually, or cause to be paid and discharged punctually, the following taxes and charges as and when the same shall become due and payable.

(i) all taxes, special and general assessments, levies, fees, water rents, rates and charges, sewer rents and other governmental impositions and charges of every kind and nature whatsoever, extraordinary as well as ordinary, foreseen and unforeseen, and each and every installment thereof which shall or may during the term of this Lease be charged, levied, laid, assessed or imposed for or with respect to the Premises or any part thereof, or any appurtenances or equipment owned by Tenant thereon or therein or any part thereof, together with all interest and penalties thereon, under or by virtue of all present or future laws, ordinances, requirements, orders, directives, rules or regulations of the federal, state, county and municipal governments and of all other governmental agencies and authorities whatsoever (all of which shall be hereinafter collectively referred to as "Taxes"); and

(ii) all other charges for water, gas, heat, hot water, oil, electricity, light and power, and other service or services furnished to the Premises or the occupants thereof during the term of this Lease (hereinafter collectively referred to as "Charges").

Tenant shall pay these Taxes and Charges within the period allowed by law or by the entity or governmental authority imposing the same during which payment is permitted without penalty or interest. Tenant shall notify the Taxing authorities, utilities and other vendors, that Tax notices and bills are to be sent to its attention.



(b) All Taxes which shall become payable during the calendar or fiscal tax years, as the case may be, in which the term of this Lease commences or terminates, shall be apportioned prorata between Landlord and Tenant in accordance with the respective portions of such year during which such term shall be in effect. Tenant's share of any such apportioned Taxes shall be paid to Landlord prior to the due date of said Taxes, provided that, in the case of Taxes apportioned at the end of the term of this Lease, Tenant shall pay its share to Landlord prior to the expiration date of this Lease.

(c) Tenant shall furnish Landlord, promptly after receipt thereof, copies of any Tax bills or notices received from any taxing authority. At Landlord's request, Tenant shall also furnish Landlord with satisfactory proof of payment of all items referred to in this Section which are payable by Tenant.

### **Section Six Maintenance, Improvements, Repairs, Additions**

(a) Landlord acknowledges that the premises is currently undeveloped land and expressly authorizes Tenant to install on the premises such surface material as Tenant deems appropriate for the use of the Premises as a parking lot at Tenant's sole cost and expense. To the extent that Tenant installs such surface Tenant shall, throughout the term of this Lease, at its sole cost and expense and to the extent necessary taking into account the parking surface intalled, maintain the parking areas, entrances, exits, sidewalks, roadways, service roads and other facilities within the Premises (the "parking areas and facilities") in good condition and repair, safe, reasonably clean and reasonably free of refuse, obstructions, ice and snow, and adequately paved and striped for parking and traffic flow. Tenant shall also, throughout the term of this Lease, and at its sole cost and expense, keep and maintain, or cause to be kept and maintained, in good repair (including structurally) and good condition, all buildings and improvements at any time situated on the Premises and shall use all reasonable precaution to prevent waste, damage or injury. All maintenance and repairs shall be in compliance with all governmental authorities. Landlord shall not be required to maintain the Premises, or to furnish any services, or to make any improvements, repairs (including structural repairs) or alterations in or to the Premises during the term of this Lease. In furtherance of its maintenance obligations under this Section, and not in limitation thereof, Tenant covenants and agrees as follows:

(i) to restripe the parking areas when necessary in order to keep the traffic lanes and parking stalls clearly and distinctly marked;

(ii) to promptly repair "pot holes" or other damages to the pavement occurring within the parking areas and facilities;

(iii) to remove all snow accumulations from the parking areas and facilities in order that the same shall remain safe for travel by vehicles and pedestrians and to not operate any type of mechanical loader in any manner that would endanger the life of the operator or others or that would damage or interfere with the continuous operation and maintenance of Landlord's electrical conductors and



associated equipment located over, along and across the Premises to accomplish such snow removal;

(iv) to promptly sand or salt any icy areas within the parking areas and facilities in order that the same shall remain safe for travel by vehicles and pedestrians;

(v) to maintain all landscaped and planted areas within the Premises in a neat and orderly condition, and to keep all grassy areas neatly mowed; and

(vi) to furnish the parking areas and facilities with a reasonable number of trash receptacles, and to periodically empty the same prior to their becoming overfilled;

### **Section Seven Use**

(a) Tenant may use the Premises for a parking area to support its abutting property.

(b) Tenant may construct a storm water management system to provide water quality treatment and quantity control of storm water runoff in accordance with the requirements of the City of Portland for the parking area.

(c) Tenant shall not bring any Hazardous Material onto the Premises, or cause or permit such materials to be brought onto the Premises. Any permitted materials must be disposed of in accordance with all applicable federal, state, county, and local laws, regulations, rules, ordinances, policies, orders, and directives (hereinafter collectively "Laws"). If, during the term of this Lease, any Hazardous Materials are brought onto the Premises, with or without the consent of Landlord, Tenant shall (1) conduct and complete all investigations, studies, sampling, and testing and all remedial, removal, and other actions necessary to clean up and remove all Hazardous Materials on, from, or affecting the Premises: (i) in accordance with all Laws; and (ii) to the satisfaction of Landlord, and (2) defend (at Landlord's option), indemnify, and hold harmless Landlord, its employees, agents, contractors, officers, and directors, from and against any and all claims, demands, penalties, fines, liabilities, settlements, damages, costs, or expenses (including, without limit, attorney and consultant fees, investigation and laboratory fees, court costs, and litigation expenses) of whatever kind or nature, known or unknown, contingent or otherwise, arising out of or in any way related to: (i) the presence, disposal, release, or threatened release of any Hazardous Materials which are on, from, or affecting the soil, water, vegetation, buildings, personal property, persons, animals, or otherwise; (ii) any personal injury (including wrongful death) or property damage (real or personal) arising out of or related to Hazardous Materials; (iii) any lawsuit brought or threatened, settlement reached, of government order relating to Hazardous Materials; (iv) any violation of Laws, or demands of government authorities; or (v) any policies or requirements of Landlord which are based upon or in any way related to Tenant's Hazardous Materials. For purposes of this Lease, "Hazardous Materials" includes, without limit, any flammable explosives, radioactive materials, hazardous materials, hazardous waste, hazardous or toxic substances, oil or petroleum products (other than those used in the motor vehicles on the Premises), asbestos, or related materials defined in the



Comprehensive Environmental Response, Compensation and Liability Act of 1980, as amended (42 U.S.C. §9601, et seq.), the Hazardous Materials Transportation Act, as amended (49 U.S.C. §2802, et seq.), the Resource Conservation and Recovery Act, as amended (42 U.S.C. §6901, et seq.), applicable Maine Statutes (including 38 M.R.S.A. Sec. 1361, et seq.; 38 M.R.S.A. §1301, et seq.; and 38 M.R.S.A. §1317, et seq.) and in the regulations adopted and publications promulgated pursuant thereto. The provisions of this Section shall be in addition to any other obligations and liabilities Tenant may have to Landlord at common law, and shall survive the termination or expiration of this Lease.

### **Section Eight Compliance with Public Authority**

During the term of this Lease, Tenant shall, at its sole cost and expense, promptly observe and comply with all present and future Laws, of all governmental authorities that relate to or govern Tenant's use of the Premises or appurtenances thereto or any part thereof whether the same are in force at the commencement of the term of this Lease or may in the future be passed, enacted or directed, and Tenant shall pay all of Landlord's costs, expenses, liabilities, losses, damages, fines, penalties, claims and demands, including reasonable attorney's fees that may in any manner arise out of or be imposed because of the failure of Tenant to comply with the covenants of this Section.

### **Section Nine Covenant Against Liens**

Tenant covenants and agrees that if any mechanics lien or other lien or claim of any kind whatsoever shall be filed or maintained against the Premises, or the Landlord, by any contractor, subcontractor, materialman or laborer employed by Tenant or Tenant's contractor or subcontractors for work done or material furnished in connection with the Premises, Tenant shall, within thirty (30) calendar days after the filing of such claim or lien, either

(i) provide a bond against the same and remove such claim or lien of record; or

(ii) furnish a waiver and release from the party originating such claim or lien as of the Premises or the Landlord.

If Tenant fails to discharge any claim or lien, Landlord shall have the right, but not the duty, to discharge any such claims or lien by payment or otherwise, and Tenant shall reimburse Landlord therefor and for all costs and expenses, including reasonable attorneys' fees, as additional rent. Tenant further agrees that all contractors, subcontractors, materialmen and laborers performing such work or providing such labor or materials shall look to and hold Tenant solely liable for all labor and materials furnished and work done for Tenant so that there shall not be any legal or lawful claim of any kind whatsoever against Landlord for any work done or labor or materials furnished in connection therewith (including but not limited to claims for unjust enrichment). Tenant shall indemnify and save harmless Landlord against and from all costs, damages,



liabilities, suits, penalties, claims and demands, including reasonable counsel fees, resulting from any such lien.

#### **Section Ten Access to Premises**

Landlord excepts and reserves to itself and its employees, agents, contractors, successors and assigns, the nonexclusive right in common with Tenant to pass and repass in suitable and convenient locations along and across the Premises to provide the Landlord, its employees, agents, contractors, successors and assigns access as it deems necessary to maintain, increase and improve its use of the Premises in its capacity as an electric utility. If such increase or improvement of use shall affect Tenant's use of the Premises, Landlord shall modify Tenant's rent accordingly. The provisions of this paragraph notwithstanding Landlord's improvements or use of the Premises shall not in any event prevent the Tenant from using at least 60% of the premises. In the event Landlord's use or improvements prevent Tenant from using at least 60% of the premises, Tenant shall have at its sole option the right to either terminate this Lease or continue this Lease at a rental rate discounted by a factor of 25% in excess of the proportional reduction in the rent for the area of the Premises no longer available to Tenant.

#### **Section Eleven Release/Indemnification**

(a) Tenant is fully familiar with the physical condition of the Premises and Landlord's adjacent property. Landlord has made no representations of whatever nature in connection with the condition of the Premises, and Tenant accepts the Premises "as is". Landlord shall not be liable for any latent or patent defects therein.

(b) Neither Landlord, nor its directors, officers, employees, agents or contractors shall be liable for, and Tenant hereby releases them from all claims for loss of life, personal injury or damage to property or business sustained by Tenant or any person claiming through Tenant resulting from any fire, accident, occurrence or condition in or upon the Premises except for claims caused solely by the negligent acts of Landlord, its employees, agents or contractors.

(c) The Tenant will defend at Landlord's option, indemnify and save harmless the Landlord and its affiliates and the directors, officers, employees, agents, and contractors of the Landlord and its affiliates, from and against any and all liabilities, penalties, claims, demands, damages, costs, fines, judgments and expenses; including, but not limited to, attorneys' fees and disbursements, and claims related to injury to or death of persons or from damage to or destruction of property of any kind or nature or damage or injury to the environment or failure of Tenant to comply with any Laws of any governmental agency or official; (i) occasioned by or arising from or out of any act or omission of Tenant or its invitees, employees, contractors, permitted subcontractors, sublessees, licensees, or its or their respective agents, employees or contractors; or (ii) related in any way to Tenant's use or occupation of the Premises or any part thereof, except for claims caused solely by the negligent acts of Landlord. Tenant shall also pay



all costs, expenses and reasonable attorneys' fees that may be expended or incurred by Landlord in successfully enforcing the terms of this Lease. Notwithstanding any other provision of this Lease, the provisions of this Section shall survive expiration or earlier termination of this Lease.

## **Section Twelve Insurance**

(a) Tenant covenants and agrees, at its sole cost and expense, to obtain, keep, and maintain in full force and effect for the term of this Lease for the mutual benefit of Landlord and Tenant, a comprehensive general liability insurance policy against claims for damage to persons or property arising out of the use and occupancy of the Premises or any part or parts whereof, with a combined limit of One Million Dollars (\$1,000,000.00) per injury or death of any one person or damage to property with no more than Five Thousand Dollars (\$25,000.00) deductible.

(b) All insurance required under this Section shall name the Landlord as an additional insured and be issued by insurers rated B+13 by the latest Best's rating guide. Tenant shall provide Landlord with a Certificate of Insurance prior to the commencement of this Lease. Such Certificate shall state that no material change or cancellation of the insurance coverage can be effective unless and until ten (10) days prior written notice has been given to Landlord. Tenant will maintain in force a Worker's Compensation policy that, at a minimum, meets state and federal requirements. Should any policy be canceled during the term of this Lease and Tenant fails to immediately procure equivalent insurance, Landlord shall have the right, at its option but without any duty to do so, to: (i) cancel this Lease as of the lapse of the policy; or (ii) pay the premiums and/or fees due and necessary to re-activate said policy, and Tenant shall repay to Landlord any such premiums and/or fees paid by Landlord together with interest from the time of payment until repaid by Tenant. Said premiums and/or fees shall be repaid to Landlord on demand as additional rent, and, without limiting Landlord's remedies, Tenant's failure to repay the same shall constitute a default under this Lease.

(c) Nothing contained in this Section shall diminish Tenant's obligations as provided elsewhere herein.

## **Section Thirteen Destruction/Eminent Domain**

(a) If the whole of the Premises shall be damaged or destroyed by fire, flood or other casualty or be taken for any public or quasi-public use under any statute or by right of eminent domain or by purchase in lieu thereof, or in the event of any other taking, purchase or casualty (hereinafter collectively "taking") which renders the remaining portion of the Premises not so taken not reasonably useable for the purposes for which the Premises were being used by Tenant just prior to such taking, then either party shall have the right, but not the obligation to terminate this Lease by giving written notice of such termination to the other party within thirty (30) days after the date of such taking, and upon the giving of such notice of termination, the term of this Lease shall expire and come to an end on the last day of the calendar month in which such notice shall be given with the same force and effect as if said day had been originally fixed herein as



the expiration date of the term of this Lease. In the event the Lease shall be so terminated, neither party shall have any further rights or liabilities hereunder, whether for the unexpired portion of this Lease or otherwise, except with respect to obligations and liabilities of Tenant hereunder, actual or contingent, which have arisen on or prior to such date of termination except as provided in the "Release/Indemnification" Section herein.

(b) Out of any award for any taking of the Premises, in condemnation proceedings or by right of eminent domain, Landlord shall be entitled to receive and retain the amounts awarded for the Premises and for Landlord's business loss. Tenant shall be entitled to receive and retain any amounts which may be specifically awarded to it in any such condemnation proceedings because of the taking of its improvements to the Premises or leasehold estate.

(c) In the event of a taking not resulting in the termination of this Lease pursuant to the provisions of this Section, this Lease shall continue in full force and effect and a proportion of the annual rent equal to the proportionate decrease in the value of the Premises as a result of such partial taking shall be abated, effective from the date of taking; provided that if the Landlord receives no award for the part so taken, then there shall be no abatement in rent.

(d) Tenant covenants that it will give notice to Landlord of any damage or casualty occurring in, on or about the Leased Premises within twenty-four (24) hours after Tenant has knowledge of the occurrence of such accident or damage.

(e) In the event of a taking (including a casualty), Landlord shall be under no obligation to repair, rebuild, or recreate any affected portion of the Premises.

#### **Section Fourteen Quiet Enjoyment**

Tenant, upon paying the basic rent, additional rent and all other sums and charges to be paid by it as herein provided, and observing and keeping all covenants, warranties, agreements and conditions of this Lease on its part to be kept, shall quietly have and enjoy the Premises during the term of this Lease, without hindrance or molestation by anyone claiming by, through or under Landlord.

#### **Section Fifteen Defaults**

The following events shall be deemed to be events of default under this Lease:

(a) Tenant shall fail to pay when due any sum of money due to be paid to Landlord, whether such sum be rent, additional rent, or any other payment or reimbursement Tenant is obligated to pay to Landlord, and such failure shall continue for a period of ten (10) business days from the date of written notice thereof to Tenant;



(b) Tenant shall fail to comply with any term, provision or covenant of this Lease other than defaults addressed in subsection 15(a) above , and shall not cure such failure within thirty (30) calendar days (or forthwith, if the default involves a hazardous condition) after written notice thereof to Tenant;

(c) The leasehold interest of Tenant shall be levied upon under execution or be attached by process of law or Tenant shall fail to contest diligently the validity of any lien or claimed lien and give sufficient security to Landlord to insure payment thereof or shall fail to satisfy any judgment rendered thereon and have the same released, and such default shall continue for thirty (30) calendar days after written notice thereof to Tenant;

(d) Tenant shall become insolvent, admit in writing its inability to pay its debts generally as they become due, file a petition in bankruptcy or a petition to take advantage of any insolvency statute, make an assignment for the benefit of creditors, make a transfer in fraud of creditors, apply for or consent to the appointment of a receiver of itself or of the whole or any substantial part of its property, or file a petition or answer seeking reorganization or arrangement under the federal bankruptcy laws, as now in effect or hereafter amended, or any other applicable law or statute of the United States or any state thereof except that Tenant shall not be in default unless and until it shall discontinue rent payments;

(e) A court of competent jurisdiction shall enter an order, judgment or decree adjudicating Tenant a bankrupt, or appointing a receiver of Tenant, or of the whole or any substantial part of its property, without the consent of Tenant, or approving a petition filed against Tenant seeking reorganization or arrangement of Tenant under the bankruptcy laws of the United States, as now in effect or hereafter amended, or any state thereof, and such order, judgment or decree shall not be vacated or set aside or stayed within ninety (90) calendar days from the date of entry thereof. Landlord shall in no event be in default in the performance of any of its obligations hereunder unless and until Landlord shall have failed to perform such obligations within thirty (30) calendar days or such additional time as is reasonably required to correct any such default after notice by Tenant to Landlord properly specifying wherein Landlord has failed to perform any such obligation.

#### **Section Sixteen Landlord's Remedies**

Upon the occurrence of any of such events of default as described in the "Default" Section of this Lease, Landlord shall have the option to pursue any one or more of the following remedies by written notice ,in addition to other remedies provided in this Lease or at law or in equity:

(a) Landlord may, at its option, terminate this Lease or terminate Tenant's right of possession only without terminating the Lease, and in the event Landlord elects to terminate this Lease as provided herein, Tenant shall not object to or in any way contest such termination;



(b) Landlord may re-enter the Premises immediately and remove property and personnel of Tenant, its successors or assigns or others using the Premises by permission of Tenant, its successors or assigns; repossess the Premises; store the property in a public warehouse or at a place selected by Landlord; all at the expense of Tenant and all without process of law, and without being deemed in any manner guilty of trespass, eviction, or forcible entry or detainer, or liable for any damage resulting therefrom; or

(c) Landlord may recover from Tenant all damages proximately resulting from the breach, which damages shall be deemed to include without limitation, damages to the Premises, and the cost of recovering the Premises, which sum shall be immediately due Landlord from Tenant. Tenant shall pay Landlord's reasonable attorney's fees for the service of Landlord's attorney in any action filed to enforce obligations under this Lease unless Tenant prevails by a final judgment and any appeal.

Pursuit of any of the foregoing remedies shall not preclude pursuit of any of the other remedies provided herein or provided by law or at equity (all such remedies being cumulative), nor shall pursuit of any remedy herein provided constitute a forfeiture or waiver of any rent due to Landlord hereunder or of any damages accruing to Landlord by reason of the violation of any of the terms, provisions and covenants herein contained. No act or thing done by Landlord or its agents during the term shall be deemed a termination of this Lease or an acceptance of the surrender of the Premises except an agreement to terminate this Lease or accept a surrender of said Premises in writing signed by Landlord. Landlord's acceptance of any payment after the occurrence of an event of default shall not be deemed as an accord, satisfaction, compromise or waiver of such default. Forbearance by Landlord in enforcing any remedy provided herein shall not be considered a waiver of such default or of Landlord's right to enforce any remedies with respect to such default. If, on account of any default beyond the period of time for cure by Tenant under the Lease, it shall become necessary or appropriate for Landlord to employ or consult with an attorney concerning, or to enforce or defend, any of Landlord's rights or remedies, Tenant agrees to pay all attorney's fees incurred by Landlord.

#### **Section Seventeen Assignment and Subletting**

(a) Tenant shall not assign, except to an affiliate of tenant, all or any part of this Lease or convey, mortgage, pledge, encumber or otherwise transfer any interest under this Lease, or permit the use or occupancy of the Premises, except to an affiliate of Tenant, unless it shall have first obtained the written consent of Landlord, which consent may not be unreasonably withheld.

(b) Within five (5) days of the execution by Tenant of any permitted assignment, sublease or other transfer, Tenant shall deliver to Landlord an executed copy thereof which, in the case of an assignment, shall contain, in a form acceptable to Landlord, a covenant on the part of the assignee to assume all the obligations of Tenant hereunder. Any such sublease shall contain a provision that is subject to all of the terms, covenants and conditions of this Lease. Tenant agrees to pay to Landlord, on demand, any reasonable costs, including attorney's fees, incurred by Landlord in connection with any request made by Tenant pursuant to this Section.



Failure of a subtenant to comply with the terms and conditions set forth for Tenant's use of the Premises shall be considered a default on the part of the Tenant. Upon cancellation, termination or expiration of this Lease, Tenant's subtenants shall become tenant(s)-at-will of the Landlord.

(c) Despite any permitted assignment, subletting or other transfer, Tenant shall not be relieved of its obligations under this Lease but shall continue to remain primarily liable hereunder and shall not be relieved of such liability by an extension of time or other indulgence granted by Landlord to any transferee, assignee or sublessee or by failure of Tenant to receive notice thereof and Tenant hereby waives all suretyship defenses.

### **Section Eighteen Force Majeure**

In any case where either party hereto is required to do any act (except for the payment of rent, additional rent and other charges by Tenant), the time for the performance thereof shall be extended by a period equal to any delay caused by or resulting from an act of God, war, civil commotion, fire or other casualty, labor difficulties, shortages of energy, labor, materials or equipment, government regulations, delays caused by either party to the other, or other causes beyond such party's reasonable control, whether such time be designated by a fixed date, a fixed time or a "reasonable time". In the event of such force majeure, the party requiring delay shall use its best efforts to minimize the extent of the delay.

### **Section Nineteen Holding Over**

In the event that Tenant shall continue to occupy the Premises after receipt of a notice to quit, after the expiration or termination of the term hereof, such occupancy shall not be deemed to extend or renew this Lease, but such occupancy shall continue as a tenancy-at-will from month-to-month upon the covenants, provisions and conditions herein contained at a rental equal to (one and one half) the rental in effect during the last year of the term hereof, prorated and payable for the period of such occupancy. This Section shall not be construed as giving Tenant any right to hold-over after the expiration of the term thereof except as is otherwise expressly provided in this Lease.

### **Section Twenty Waivers**

Failure of Landlord to complain of any act or omission on the part of Tenant, no matter how long the same may continue, shall not be deemed to be a waiver by Landlord of any of its rights hereunder. No waiver by Landlord at any time, express or implied of any breach of any provision of this Lease shall be deemed a waiver of a breach of any other provision of this Lease or a consent to any subsequent breach of the same or any other provision. If any action by Tenant shall require the consent or approval of Landlord, Landlord's consent or approval of such action on any one occasion shall not be deemed a consent to or approval of said action on any

subsequent occasion or a consent to or approval of any other action on the same or any subsequent occasion.

### **Section Twenty-One Notices**

All notices and other communications authorized or required hereunder shall be in writing and shall be personally delivered or sent by certified mail or registered mail, return receipt requested, postage prepaid or by facsimile (with oral confirmation if sent by facsimile transmission). Facsimile transmissions sent to Landlord shall be sent to the Lease Manager or another authorized real estate agent of Landlord. Any such notice or other communication shall be deemed to have been given when received by the party to whom such notice or other communication shall be addressed. Notices to the Tenant shall be mailed to the address in the first paragraph of this Lease. Notices to the Landlord shall be mailed to Landlord, Central Maine Power Company at 83 Edison Drive, Augusta, Maine 04336, Attention: Manager, Real Estate Services. Either party may change an address set forth in this Section by providing written notice of such change to the other; such change to be effective five (5) business days after receipt.

### **Section Twenty-Two Invalidity of Particular Provisions**

If any term or provision of this Lease or the application thereof to any person or circumstance shall, to any extent, be invalid or unenforceable, the remainder of this Lease, or the application of such term or provision to persons or circumstances other than those as to which it is held invalid or unenforceable, shall not be affected hereby, and each term and provision of this Lease shall be valid and enforced to the fullest extent permitted by law.

### **Section Twenty-Three Interpretation; Parties**

Any pronoun shall be read in the singular or plural number and in such gender as the context may require. Except as herein otherwise provided, the terms and provisions of this Lease shall be binding upon and inure to the benefit of the heirs, executors, administrators, successors and assigns, respectively, of Landlord and Tenant. The word "Landlord", as used herein, means only the owner for the time being of Landlord's interest in this Lease, and, in the event of any transfer of Landlord's interest in this Lease the transferor shall cease to be liable, and shall be released from all liability for the performance or observance of any agreements or conditions on the part of Landlord to be performed or observed subsequent to the time of said transfer, provided that from and after transfer the transferee shall assume and be liable for the performance and observance of said agreements and conditions.

### **Section Twenty-Four Entire Agreement**



This instrument contains the entire and only agreement between the parties, and no oral statements or representations or prior written matter not contained in this instrument shall have any force or effect. This Lease shall not be modified in any way except by a writing executed by both parties.

**Section Twenty-Five  
Estoppel Certificates**

The Tenant agrees, at any time, and from time to time, upon not less than ten (10) days' prior request by Landlord, to execute, acknowledge and deliver to Landlord a statement in writing certifying, if such be the case, that this Lease is unmodified and in full force and effect (or, if there have been modifications, stating the modifications, and that the lease as modified is in full force and effect), and that there are no defenses or offsets thereto then accrued, or stating those claimed by Tenant, and the dates to which the rent and other charges have been paid, it being intended that any such statement delivered pursuant to this Section may be relied upon by any prospective purchaser of, or any prospective holder of a mortgage upon the fee of the Premises, or by any other properly interested party.

**Section Twenty-Six  
Limitation of Liability**

Tenant agrees to look solely to Landlord's interest in the Premises for recovery of any judgment from Landlord; it being agreed that Landlord is not corporately liable for any such judgment. The provision contained in the foregoing sentence shall not limit any right that Tenant might otherwise have to obtain any injunctive relief against Landlord or Landlord's successors in interest, or any other action not involving the corporate liability of Landlord.

**Twenty-Seven  
Termination**

Upon expiration, or termination of this Lease, Tenant shall quit and peacefully surrender the Premises and improvements thereon, as improved during the term of this Lease, except for ordinary wear and tear. At termination, title to all improvements constructed on the premises by Tenant and not removed by Tenant prior to termination, shall transfer to Landlord, at Landlord's option, without additional consideration. Tenant may not remove pavement or fixtures installed on the premises without Landlord's prior written consent.

**Section Twenty-Eight  
Successors and Assigns**

The obligation of this Lease shall run with the land, and this Lease shall be binding upon and inure to the benefit of the parties hereto and their respective successors and assigns, except that the original Landlord named herein and each successive owner of the Premises shall be liable only for the obligations accruing during the period of its ownership.

*IN WITNESS WHEREOF*, the duly authorized representatives of the parties have executed this Lease, for the parties, under seal, as of the day and year first above written.

**WITNESSES**

**LANDLORD  
CENTRAL MAINE POWER COMPANY**

\_\_\_\_\_

\_\_\_\_\_  
BY: Alice Richards  
ITS: Supervisor, Real Estate Services

**TENANT  
Eyecare Medical Group**

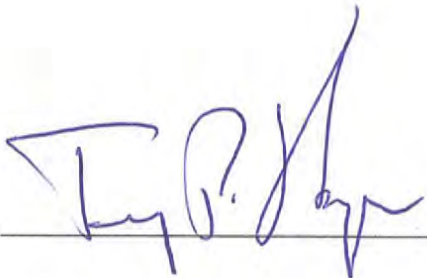
  
\_\_\_\_\_

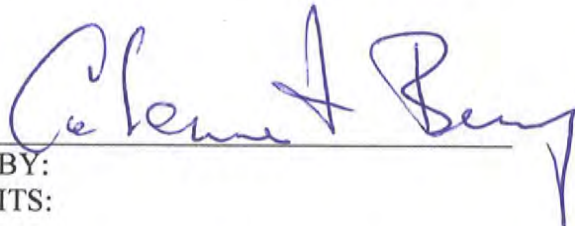
  
\_\_\_\_\_  
BY:  
ITS:





## GOVERNOR'S DEED

KNOW ALL PERSONS BY THESE PRESENTS, that the STATE OF MAINE, acting by and through its Governor, on recommendation of the Commissioner of its DEPARTMENT OF TRANSPORTATION, under and pursuant to the provisions of 23 M.R.S.A., Section 61, for consideration, the sufficiency of which is hereby acknowledged, RELEASES to EYE VENTURE ASSOCIATES, LLP a Maine limited liability partnership with a contact partner address at 53 Sewall Street, Portland, Maine, its successors and assigns, forever, all its right, title and interest in and to a certain lot or parcel of land situated on the easterly side of Powsland Street, so-called, in Portland, County of Cumberland and State of Maine, and being as shown on a Right-of-way Map for State Highway "295", Portland, Cumberland County, Federal Aid Project No. I-295-3(24), Temporary Road, File Number 3-185, Sheet 42 of 73 Sheets, dated November 1968, bounded and described as follows:

BEGINNING at a point on the easterly line of Powsland Street, so called, about two hundred four (204) feet northerly from the northerly line of Portland Terminal Co., as measured along the easterly line of Powsland Street;

THENCE northerly along the easterly line of Powsland Street one hundred (100) feet to land now or formerly of Louis P. Conley et. al.;

THENCE easterly along land of said Conley one hundred (100) feet to land now or formerly of Portland Terminal Co.;

THENCE southerly along land of said Portland Terminal Co. one hundred (100) feet to land now or formerly of Central Maine Power Co.;



THENCE westerly along land of said Central Maine Power Co. one hundred (100) feet to the POINT OF BEGINNING, and containing about ten thousand square feet, more or less (10,000 sq. ft ±).

SUBJECT TO all utility easements and installations located on the above described premises, including those shown on the herein referred to Right-of-way Map, and to those rights which any utility enjoys over the subject premises for maintenance, location or relocation of poles and other installations.

BEING the same premises acquired by the State of Maine from Arthur John Gallant and Viola M. Gallant by warranty deed dated December 15, 1972 and recorded December 20, 1972 at the Cumberland County Registry of Deeds in Volume 3341 at Page 52.

THE STATE OF MAINE makes no representations or warranties with respect to the premises hereby conveyed. The representations and warranties so excluded encompass, but are not limited to, those pertaining to: land use and environmental matters; fitness of the premises or any portion thereof for any particular purposes; water quality or quantity; the condition or quality of the soil; inchoate or unrecorded liens; status of title to or rights within that area lying between the high and low water marks; or the existence, status, or condition of access to, or public utilities serving the premises. Any subsequent use of, improvement to, or construction on the parcel shall be subject to all applicable laws, regulations, ordinances, and permitting requirements.

IN WITNESS WHEREOF, I, John E. Baldacci, Governor of the State of Maine, have caused the name and Great Seal of the State of Maine to be hereunto affixed this 18<sup>th</sup> day of June in the year two thousand six.

STATE OF MAINE

By: John E. Baldacci, Governor  
John E. Baldacci



Affixed by: [Signature]  
Secretary of State

STATE OF MAINE  
Kennebec, ss.

June 1, 2006

Personally appeared the above-named, John E. Baldacci, Governor of the State of Maine and acknowledged the foregoing instrument to be his free act and deed in his said capacity and the free act and deed of the State of Maine.

Before me, Rosemarie D. Smith  
Notary Public/Attorney at Law

Print Name: ROSEMARIE D. SMITH

My commission expires January 6, 2009  
Notary Public, Maine  
My Commission Expires

28966

Know All Men by These Presents, That We, Arthur John Gallant and Viola M. Gallant, both of Portland, County of Cumberland and State of Maine,

in consideration of ONE DOLLAR and other valuable considerations paid by the State of Maine, the receipt whereof is hereby acknowledged, do hereby give, grant, bargain, sell and convey unto the said State of Maine, its successors and assigns forever, the following described lot or parcel of land ~~known~~ with buildings situated in Portland, County of Cumberland and State of Maine, bounded and described as follows, to wit:

Beginning at a point on the present easterly line of Powland Street, so-called, about two hundred four (204) feet northerly from the intersection of the easterly line of Powland Street and the northerly line of Portland Terminal Co.;

Thence northerly along the easterly line of Powland Street one hundred (100) feet to land now or formerly of Louis P. Conley et al;

Thence easterly along land now or formerly of said Conley et al one hundred (100) feet to land now or formerly of Portland Terminal Co.;

Thence southerly along land now or formerly of said Portland Terminal Co. one hundred (100) feet to land now or formerly of Central Maine Power Co.;

Thence westerly along land now or formerly of said Central Maine Power Co. one hundred (100) feet to the point of beginning.

Said lot or parcel of land contains about 10,000 square feet.

Meaning and intending to convey and hereby conveying the same premises conveyed to the Grantors herein as joint tenants by Warranty Deed of Ashley L. and Verna D. Jordan dated October 30, 1950 and recorded in the Cumberland County Registry of Deeds, Book 2024, Page 42.

Being lots 76 and 77 as shown on a plan of land of Martin Curran, Jr. which plan is recorded in the Cumberland County Registry of Deeds, Plan Book 9, Page 121.

TO HAVE AND TO HOLD the aforegranted premises, with all the privileges and appurtenances thereof, to the said State of Maine, its successors and assigns forever. AND we do covenant with the said Grantee, its successors and assigns that we are lawfully seized in fee of the premises; that they are free of all incumbrances; that we have good right to sell and convey the same to the said Grantee and that we and our heirs shall and will warrant and defend the same to the said Grantee, its successors and assigns forever, against the lawful claims and demands of all persons.

IN WITNESS WHEREOF, We, the said Arthur John Gallant and Viola M. Gallant, husband and wife,

Signed, sealed and delivered in the presence of us, the undersigned, this 15th day of DECEMBER in the year of our Lord one thousand nine hundred and seventy-two.

SIGNED, SEALED and DELIVERED In the presence of [Signature] To [Signature]

Arthur J. Gallant Viola M. Gallant

STATE OF MAINE, COUNTY of Cumberland:

Personally appeared the above named Arthur John Gallant and acknowledged the above instrument to be his free act and deed.

DEC 15 19 72 [Signature] Justice of Peace. Notary Public.

REGISTRY OF DEEDS, CUMBERLAND COUNTY, MAINE Before me, Received at 2 H 05 PM, and recorded on DEC 20 1972 BOOK 3341 PAGE 52 to with Reg Co Register

## **Exhibit 6**

---

### **Stormwater Management Report, Inspection, Maintenance and Housekeeping Plan & Stormwater Calculations**



## **Stormwater Management Report**

EyeCare Medical Group  
53 Seawall Street  
Portland, Maine 04102

### **General**

The following Stormwater Management Plan has been prepared for EyeCare Medical Group to evaluate stormwater runoff and erosion control for the proposed parking lot expansion.

Project improvement will include a 23-space paved parking lot expansion with a vegetated underdrained soil filter for treating and controlling stormwater runoff from the site.

We designed this project in accordance with the General Standards of Maine Department of Environmental Protection's Stormwater Management Law, even though the proposed development size (roughly 6,000 square feet), and age of the existing development does not trigger a State of Maine DEP review or permit. The existing site development was built prior to 1997 Chapter 500 Stormwater regulations and the new impervious surface is less than the 1-acre minimum.

### **Site Characteristics**

The project is located near the southerly end of Powsland Street, and between a residential home and vacant land owned by Central Maine Power. The site is currently forested. The topography slopes at a rate of 2-3% in a southwesterly direction across the site towards the discontinuous portion of Powsland Street. This runoff eventually drains to a large pond adjacent to the railroad tracks. This pond provides stormwater detention for this development area. We found no apparent outlet from the pond.

### **Stormwater Management**

To mitigate peak runoff and treat stormwater, we have proposed a vegetated underdrained soil filter. The proposed filter has been designed in accordance with the latest MDEP Chapter 500 regulations. An existing underdrained soil filter that provides stormwater treatment for an existing parking lot constructed in 2009 will be decommissioned with the creation of the new parking lot. Consequently, the proposed underdrained soil filter is designed with the capacity to treat runoff from the existing parking lot immediately to the north. Stormwater runoff from the existing and proposed parking lots will be directed to a pretreatment sediment trap before entering the filter system. Stormwater will be detained within the soil filter's water quality volume (WQV) and slowly filtrate through the soil media filter where it will be conveyed via a 6" underdrain pipe to a catch basin which discharges directly into an existing storm drain pipe on site. The existing storm drain system outlets to the same large pond adjacent to the railroad tracks as in the pre-development.

### **Summary**

The EyeCare Medical project will include a comprehensive grading and drainage plan responsive to site characteristics and topographical conditions. We designed this project to meet the Maine Department of

Environmental Protection's Stormwater Management Law. As presented in the analysis and depicted on the site plans, stormwater runoff discharging from the site will be collected and pretreated in a sediment forebay before entering underdrained vegetated filter system. A site-specific erosion and sedimentation control plan is also proposed to address during and after construction conditions. Temporary erosion control measures will be implemented during the construction phase of the project as specified on the Erosion & Sedimentation Control Plan as provided on the site plans.

Permanent erosion control measures have also been incorporated into the plan for long-term stabilization of the site. These measures will be integrated with the overall site development, which includes limits for disturbance and clearing (see clearing limits on site plans), and a permanent revegetation plan.

Prepared by:

SEBAGO TECHNICS, INC.

A handwritten signature in black ink that reads "Craig Burgess". The signature is written in a cursive, flowing style.

Craig Burgess, PE  
Project Engineer

CAB/llg

## INSPECTION, MAINTENANCE, AND HOUSEKEEPING PLAN

**Eyecare Medical Group  
53 Sewall Street  
Portland, Maine 04102**

### Introduction

The following plan outlines the anticipated inspection and maintenance procedures for the erosion and sedimentation control measures as well as stormwater management facilities for the project. This plan also outlines several housekeeping requirements that shall be followed during and after construction. These procedures shall be followed in order to ensure the intended function of the designed measures and to prevent unreasonably adverse impacts to the surrounding environment.

The procedures outlined in this Inspection, Maintenance and Housekeeping Plan are provided as an overview of the anticipated practices to be used on this site. In some instances, additional measures may be required due to unexpected conditions. For additional detail on any of the erosion and sedimentation control measures or stormwater management devices to be utilized on this project, refer to the most recently revised edition of the "Maine Erosion and Sedimentation Control BMP" manual and/or the "Stormwater Management for Maine: Best Management Practices" manual as published by the Maine Department of Environmental Protection (MDEP).

### During Construction

1. **Inspection:** During the construction process, it is the Contractor's responsibility to comply with the inspection and maintenance procedures outlined in this section. These responsibilities include inspecting disturbed and impervious areas, erosion control measures, materials storage areas that are exposed to precipitation, and locations where vehicles enter or exit the site. These areas shall be inspected at least once a week as well as before and after a storm event, and prior to completing permanent stabilization measures. A person with knowledge of erosion and stormwater control, including the standards and conditions in any applicable permits, shall conduct the inspections.
2. **Maintenance:** All measures shall be maintained in an effective operating condition until areas are permanently stabilized. If Best Management Practices (BMPs) need to be maintained or modified, additional BMPs are necessary, or other corrective action is needed, implementation must be completed within 7 calendar days and prior to any storm event (rainfall).
3. **Documentation:** A log summarizing the inspections and any corrective action taken must be maintained on-site. The log must include the name(s) and qualifications of the person making the inspections, the date(s) of the inspections, and major observations about the operation and maintenance of erosion and sedimentation controls, material storage areas, and vehicle access points to the site. Major observations must include BMPs that need maintenance, BMPs that failed to operate as designed or proved inadequate for a particular location, and locations where additional BMPs are needed. For each BMP requiring maintenance, BMP needing replacement, and location needing additional BMPs, note in the log the corrective action taken and when it was

taken. The log must be made accessible to the appropriate regulatory agency upon request. The permittee shall retain a copy of the log for a period of at least three years from the completion of permanent stabilization.

4. **Specific Inspection and Maintenance Tasks:** The following is a list of erosion control and stormwater management measures and the specific inspection and maintenance tasks to be performed during construction.

A. Sediment Barriers:

- Hay bale barriers, silt fences, and filter berms shall be inspected immediately after each rainfall and at least daily during prolonged rainfall.
- If the fabric on a silt fence or filter barrier should decompose or become ineffective prior to the end of the expected usable life and the barrier is still necessary, it shall be replaced.
- Sediment deposits should be removed after each storm event. They must be removed before deposits reach approximately one-half the height of the barrier.
- Filter berms shall be reshaped as needed.
- Any sediment deposits remaining in place after the silt fence or filter barrier is no longer required should be dressed to conform to the existing grade, prepared, and seeded.

B. Riprap Materials:

- Once a riprap installation has been completed, it should require very little maintenance. It shall, however, be inspected periodically to determine if high flows have caused scour beneath the riprap or dislodged any of the stone.

C. Erosion Control Blankets:

- Inspect these reinforced areas semi-annually and after significant rainfall events for slumping, sliding, seepage, and scour. Pay close attention to unreinforced areas adjacent to the erosion control blankets, which may experience accelerated erosion.
- Review all applicable inspection and maintenance procedures recommended by the specific blanket manufacturer. These tasks shall be included in addition to the requirements of this plan.

D. Stabilized Construction Entrances/Exits:

- The exit shall be maintained in a condition that will prevent tracking of sediment onto public rights-of-way.
- When the control pad becomes ineffective, the stone shall be removed along with the collected soil material. The entrance should then be reconstructed.
- Areas that have received mud-tracking or sediment deposits shall be swept or washed. Washing shall be done on an area stabilized with aggregate, which drains into an approved sediment-trapping device (not into storm drains, ditches, or waterways).



E. Temporary Seed and Mulch:

- Mulched areas should be inspected after rain events to check for rill erosion.
- If less than 90% of the soil surface is covered by mulch, additional mulch shall be applied in bare areas.
- In applications where seeding and mulch have been applied in conjunction with erosion control blankets, the blankets must be inspected after rain events for dislocation or undercutting.
- Mulch shall continue to be reapplied until 95% of the soil surface has established temporary vegetative cover.

F. Stabilized Temporary Drainage Swales:

- Sediment accumulation in the swale shall be removed once the cross section of the swale is reduced by 25%.
- The swales shall be inspected after rainfall events. Any evidence of sloughing of the side slopes or channel erosion shall be repaired and corrective action should be taken to prevent reoccurrence of the problem.
- In addition to the stabilized lining of the channel (i.e. erosion control blankets), stone check dams may be needed to further reduce channel velocity.

5. **Housekeeping:** The following general performance standards apply to the proposed project.

- A. Spill prevention: Controls must be used to prevent pollutants from being discharged from materials on-site, including storage practices to minimize exposure of the materials to stormwater, and appropriate spill prevention, containment, and response planning and implementation.
- B. Groundwater protection: During construction, liquid petroleum products and other hazardous materials with the potential to contaminate groundwater may not be stored or handled in areas of the site draining to an infiltration area. An "infiltration area" is any area of the site that by design or as a result of soils, topography and other relevant factors, accumulates runoff that infiltrates into the soil. Dikes, berms, sumps, and other forms of secondary containment that prevent discharge to groundwater may be used to isolate portions of the site for the purposes of storage and handling of these materials.
- C. Fugitive sediment and dust: Actions must be taken to insure that activities do not result in noticeable erosion of soils or fugitive dust emissions during or after construction. Oil may not be used for dust control.
- D. Debris and other materials: Litter, construction debris, and chemicals exposed to stormwater must be prevented from becoming a pollutant source.
- E. Trench or foundation dewatering: Trench dewatering is the removal of water from trenches, foundations, cofferdams, ponds, and other areas within the construction area that retain water after excavation. In most cases, the collected water is heavily silted and hinders correct and safe construction practices. The collected water must be removed from the ponded area, either through gravity or pumping, and must be spread through natural wooded buffers or removed to areas that are specifically designed to

collect the maximum amount of sediment possible, like a cofferdam sedimentation basin. Avoid allowing the water to flow over disturbed areas of the site. Equivalent measures may be taken if approved.

### **Post-Construction**

1. **Inspection:** After construction, it is the responsibility of the owner or assigned heirs to comply with the inspection and maintenance procedures outlined in this section. All measures must be maintained in effective operating condition. The owner or operator of a BMP shall hire a qualified post-construction stormwater inspector to at least annually, inspect the BMPs, including but not limited to any parking areas, catch basins, drainage swales, detention basins and ponds, pipes and related structures, in accordance with all municipal and state inspection, cleaning and maintenance requirements of the approved post-construction stormwater management plan.
2. **Specific Inspection and Maintenance Tasks:** The following is a list of permanent erosion control and stormwater management measures and the inspection and maintenance tasks to be performed after construction. If the BMP requires maintenance, repair or replacement to function as intended by the approved post-construction stormwater management plan, the owner or operator of the BMP shall take corrective action(s) to address the deficiency or deficiencies as soon as possible after the deficiency is discovered and shall provide a record of the deficiency and corrective action(s) to the department of public services (“DPS”) in the annual report

A. Vegetated Areas:

- Inspect vegetated areas, particularly slopes and embankments, early in the growing season or after heavy rains to identify active or potential erosion problems.
- Replant bare areas or areas with sparse growth. Where rill erosion is evident, armor the area with an appropriate lining or divert the erosive flows to on-site areas able to withstand the concentrated flows.

B. Ditches, Swales and Other Open Channels:

- Inspect ditches, swales, level spreaders and other open stormwater channels in the spring, in the late fall, and after heavy rains to remove any obstructions to flow. Remove accumulated sediments and debris, remove woody vegetative growth that could obstruct flow, and repair any erosion of the ditch lining.
- Vegetated ditches must be mowed at least annually or otherwise maintained to control the growth of woody vegetation and maintain flow capacity.
- Any woody vegetation growing through riprap linings must also be removed. Repair any slumping side slopes as soon as practicable.
- If the ditch has a riprap lining, replace riprap in areas where any underlying filter fabric or underdrain gravel is showing through the stone or where stones have dislodged.

C. Culverts:

- Inspect culverts in the spring, in the late fall, and after heavy rains to remove any obstructions to flow.
- Remove accumulated sediments and debris at the inlet, at the outlet, and within the conduit.
- Inspect and repair any erosion damage at the culvert's inlet and outlet.

D. Removal of Winter Sand:

- Clear accumulations of winter sand in parking lots and along roadways at least once a year, preferably in the spring.
- Accumulations on pavement may be removed by pavement sweeping.
- Accumulations of sand along road shoulders may be removed by grading excess sand to the pavement edge and removing it manually or by a front-end loader or other acceptable method.

E. Underdrained Soil Filter:

- During the first year, the basin shall be inspected semi-annually and following major storm events.
- Debris and sediment buildup shall be removed from the forebay and basin as needed. Mowing of a grassed basin can occur semiannually to a height no less than 6 inches. Any bare area or erosion rills shall be repaired with new filter media or sandy loam then seeded and mulched. Maintaining good grass cover will minimize clogging with fine sediments and if ponding exceeds 48 hours, the top of the filter bed must be rototilled to reestablish the soil's filtration capacity.
- The soil filter should be inspected after every major storm in the first year to be sure it is functioning properly. Thereafter, the filter should be inspected at least once every six months to ensure that it is draining within 48 hours following a one inch storm or greater. Following storms that fill the system and overflow is observed, the soil filter should drain in no less than 36 to 60 hours. If the system drains too fast, an orifice may need to be added on the underdrain outlet or, if already present, may need to be modified.
- Soil Filter Replacement: The top several inches of the filter shall be replaced with fresh material when water ponds on the surface of the bed for more than 72 hours. Removed sediments should be disposed of in an acceptable manner.
- Sediment Removal: Sediment and plant debris should be removed from the pretreatment structure at least annually.
- Mowing: If mowing is desired, only handheld string trimmers or push-mowers are allowed on the filter (no tractor) and the grass bed should be mowed no more than 2 times per growing season to maintain grass heights of no less than 6 inches.
- Fertilization: Fertilization of the underdrained filter area should be avoided unless absolutely necessary to establish vegetation.
- Harvesting and Weeding: Harvesting and pruning of excessive growth will need to be done occasionally. Weeding to control unwanted or invasive plants may also be necessary.
-

**3. Documentation:**

- A. The owner or operator of a BMP or a qualified post-construction stormwater inspector hired by that person, shall, on or by June 30 of each year, provide a completed and signed certification to DPS in a form provided by DPS, certifying that the person has inspected the BMP(s) and that they are adequately maintained and functioning as intended by the approved post-construction stormwater management plan, or that they required maintenance or repair, including the record of the deficiency and corrective action(s) taken.
  
- B. A log summarizing the inspections and any corrective action taken must be maintained. The log must include the name(s) and qualifications of the person making the inspections, the date(s) of the inspections, and major observations about the operation and maintenance of controls. Major observations must include BMPs that need maintenance, BMPs that failed to operate as designed or proved inadequate for a particular location, and locations where additional BMPs are needed. For each BMP requiring maintenance, BMP needing replacement, and location needing additional BMPs, note in the log the corrective action taken and when it was taken. The log must be made accessible to the appropriate regulatory agency upon request. A sample “Stormwater Inspection and Maintenance Form” has been included as Attachment 1 of this Inspection, Maintenance, and Housekeeping Plan.

- 4. **Duration of Maintenance:** Perform maintenance as described and required for any associated permits unless and until the system is formally accepted by a municipality or quasi-municipal district, or is placed under the jurisdiction of a legally created association that will be responsible for the maintenance of the system. If a municipality or quasi-municipal district chooses to accept a stormwater management system, or a component of a stormwater system, it must provide a letter to the MDEP stating that it assumes responsibility for the system. The letter must specify the components of the system for which the municipality or district will assume responsibility, and that the municipality or district agrees to maintain those components of the system in compliance with MDEP standards. Upon such assumption of responsibility, and approval by the MDEP, the municipality, quasi-municipal district, or association becomes a co-permittee for this purpose only and must comply with all terms and conditions of the permit.

**Attachments**

Attachment 1 – Sample Stormwater Inspection and Maintenance Log Form

**ATTACHMENT 1 - STORMWATER INSPECTION AND MAINTENANCE LOG**

**Eyecare Medical Group  
53 Sewall Street  
Portland, Maine 04102**

This log is intended to accompany the Inspection, Maintenance and Housekeeping Plan for the proposed parking lot expansion at 53 Sewall Street, Portland, Maine. The following items shall be checked, cleaned and maintained on a regular basis as specified in the Maintenance Plan and as described in the table below. This log shall be kept on file for a minimum of five (5) years and shall be available for review by the municipality. Qualified personnel familiar with drainage systems shall perform all inspections. Attached is a copy of the construction and post-construction maintenance logs.

	INSPECTOR NAME	DATE PERFORMED	SUGGESTED INTERVAL
<b>Vegetated Areas</b>			
Inspect all slopes and embankments			Annually
Replant bare areas or areas with sparse growth			Annually
<b>Gravel Surfaces</b>			
Clear accumulated winter sand			Annually
Remove sediment along edges and in pockets			Annually
<b>Ditches &amp; Swales</b>			
Remove any obstructions and accumulated sediments and debris			Monthly
Repair any erosion of ditch lining			Annually
Mow vegetated ditches			Annually
Remove woody vegetation growing through riprap			Annually
Repair any slumping side slopes			Annually
Replace riprap where stones have dislodged			Annually
<b>Culverts</b>			
Remove accumulated sediments and debris at the inlet, outlet, within conduit			Annually
Repair any erosion at inlet and outlet			Annually
Sump Depth			Annually
<b>Underdrained Soil Filter</b>			
Remove sediment & debris			Monthly
Remove weeds			Monthly (during growing season)
Erosion (side slopes, embankment)			Monthly
Inspection after major storm to verify proper function			Bi-Annually
Mowed			As-needed

**SEBAGO TECHNICS, INC.**

75 John Roberts Road Suite 1A

South Portland, Maine 04106

Tel. (207) 200-2100

JOB 06267

SHEET NO.

1

OF

1

CALCULATED BY

ACH

DATE

11/3/2014

FILE NAME

PRNT DATE

11/11/2014

UNDERDRAINED SOIL FILTER									
Task:	Calculate water quality volume per MDEP Chapter 500 regulations								
References	1. Maine DEP Chapter 500, Section 4.B.(2)(b)								
	a.	"must detain a runoff volume equal to 1.0 inch times the subcatchment's impervious area plus 0.4 inch times the subcatchment's landscaped area"							
	2. Maine DEP Best Management Practices Stormwater Manual, Section 7.1								
	a.	"surface area of the filter must be no less than the sum of 5% of the impervious area and 2% of the landscaped area draining to the filter"							
<u>Tributary to Underdrained Filter</u>									
	Landscaped Area	0.093	acres						
	Impervious Area	0.268	acres						
<u>Minimum Surface Area</u>									
	Required	(2% x Landscaped + 5% x Impervious)							
	Total Landscaped Area	0.093	acres	=	81.0	SF			
	Total Impervious Area	0.268	acres	=	583.7	SF			
	Required Minimum Surface Area				664.7	SF			
	Provided Surface Area				687.2	SF			
<u>Channel Protection Volume (CPV)</u>									
	Required	(0.4" x Landscaped + 1.0" x Impervious)							
	Landscaped Area	0.093	acres	Volume	135.0	CF			
	Impervious Area	0.268	acres	Volume	972.8	CF			
	CPV Required				1,107.9	CF			
	Provided CPV				1,151.0	CF	(Elevation 29.50 to 30.66)		

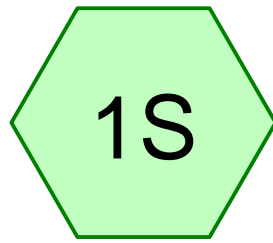

1S

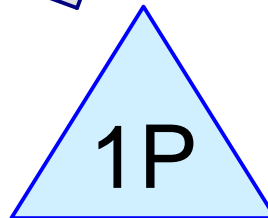
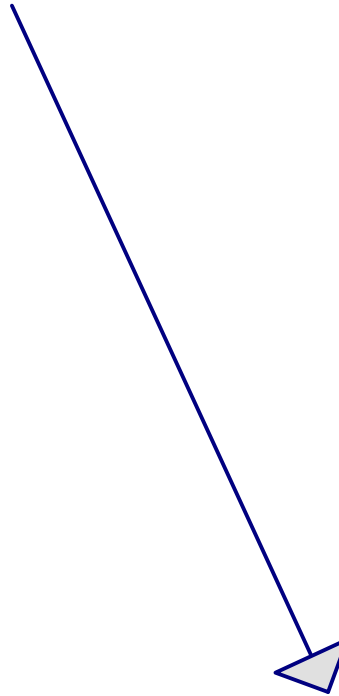

UDSF

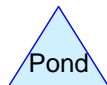
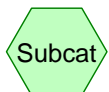

**Summary for Subcatchment 1S: 1S**

Runoff = 1.89 cfs @ 12.07 hrs, Volume= 0.138 af, Depth= 4.58"

Runoff by SCS TR-20 method, UH=SCS, Time Span= 0.00-36.00 hrs, dt= 0.01 hrs  
Type III 24-hr 25yr Rainfall=5.50"

Area (ac)	CN	Description
* 0.268	98	Parking Lot
0.093	74	>75% Grass cover, Good, HSG C
0.361	92	Weighted Average
0.093		Pervious Area
0.268		Impervious Area

Tc (min)	Length (feet)	Slope (ft/ft)	Velocity (ft/sec)	Capacity (cfs)	Description
5.0					Direct Entry,

**Summary for Pond 1P: UDSF**

Inflow Area = 0.361 ac, 74.24% Impervious, Inflow Depth = 4.58" for 25yr event  
 Inflow = 1.89 cfs @ 12.07 hrs, Volume= 0.138 af  
 Outflow = 1.60 cfs @ 12.12 hrs, Volume= 0.138 af, Atten= 15%, Lag= 2.8 min  
 Primary = 1.60 cfs @ 12.12 hrs, Volume= 0.138 af  
 Secondary = 0.00 cfs @ 0.00 hrs, Volume= 0.000 af

Routing by Stor-Ind method, Time Span= 0.00-36.00 hrs, dt= 0.01 hrs  
 Peak Elev= 30.75' @ 12.12 hrs Surf.Area= 1,360 sf Storage= 1,803 cf

Plug-Flow detention time= 191.0 min calculated for 0.138 af (100% of inflow)  
 Center-of-Mass det. time= 190.9 min ( 969.8 - 778.8 )

Volume	Invert	Avail.Storage	Storage Description		
#1	27.00'	3,958 cf	<b>Custom Stage Data (Prismatic)</b> Listed below		
Elevation (feet)	Surf.Area (sq-ft)	Voids (%)	Inc.Store (cubic-feet)	Cum.Store (cubic-feet)	
27.00	688	30.0	0	0	
29.49	688	30.0	514	514	
29.50	688	100.0	7	521	
30.00	945	100.0	408	929	
30.66	1,306	100.0	743	1,672	
31.00	1,502	100.0	477	2,149	
32.00	2,115	100.0	1,809	3,958	

Device	Routing	Invert	Outlet Devices
#1	Primary	26.20'	<b>8.0" x 4.0' long 8" SD</b> CPP, projecting, no headwall, Ke= 0.900 Outlet Invert= 25.50' S= 0.1750 1/ Cc= 0.900 n= 0.013 Corrugated PE, smooth interior
#2	Device 1	30.66'	<b>0.17' x 0.17' Horiz. CB Grate X 36.00</b> Limited to weir flow C= 0.600



#3	Device 1	27.00'	<b>6.0" x 82.0' long 6" UD</b> CPP, projecting, no headwall, Ke= 0.900 Outlet Invert= 26.26' S= 0.0090 '/' Cc= 0.900 n= 0.013 Corrugated PE, smooth interior
#4	Device 3	27.00'	<b>2.410 in/hr Filtration to UD over Surface area</b>
#5	Secondary	30.90'	<b>5.0' long x 4.0' breadth Overflow Spillway</b> Head (feet) 0.20 0.40 0.60 0.80 1.00 1.20 1.40 1.60 1.80 2.00 2.50 3.00 3.50 4.00 4.50 5.00 5.50 Coef. (English) 2.38 2.54 2.69 2.68 2.67 2.67 2.65 2.66 2.66 2.68 2.72 2.73 2.76 2.79 2.88 3.07 3.32

**Primary OutFlow** Max=1.60 cfs @ 12.12 hrs HW=30.75' (Free Discharge)

- ↑ 1=8" SD (Passes 1.60 cfs of 2.73 cfs potential flow)
- ↑ 2=CB Grate (Orifice Controls 1.53 cfs @ 1.47 fps)
- ↑ 3=6" UD (Passes 0.08 cfs of 1.09 cfs potential flow)
- ↑ 4=Filtration to UD (Exfiltration Controls 0.08 cfs)

**Secondary OutFlow** Max=0.00 cfs @ 0.00 hrs HW=27.00' (Free Discharge)

- ↑ 5=Overflow Spillway ( Controls 0.00 cfs)

**06267 ACH 110314**

Prepared by Sebago Technics

HydroCAD® 8.50 s/n 001856 © 2007 HydroCAD Software Solutions LLC

*Type III 24-hr 2yr Rainfall=3.00"*

Printed 11/11/2014

Page 4

Time span=0.00-36.00 hrs, dt=0.01 hrs, 3601 points

Runoff by SCS TR-20 method, UH=SCS

Reach routing by Stor-Ind+Trans method - Pond routing by Stor-Ind method

**Subcatchment 1S: 1S**

Runoff Area=0.361 ac 74.24% Impervious Runoff Depth=2.16"

Tc=5.0 min CN=92 Runoff=0.93 cfs 0.065 af

**Pond 1P: UDSF**

Peak Elev=30.34' Storage=1,313 cf Inflow=0.93 cfs 0.065 af

Primary=0.06 cfs 0.065 af Secondary=0.00 cfs 0.000 af Outflow=0.06 cfs 0.065 af

**Total Runoff Area = 0.361 ac Runoff Volume = 0.065 af Average Runoff Depth = 2.16"**  
**25.76% Pervious = 0.093 ac 74.24% Impervious = 0.268 ac**

Time span=0.00-36.00 hrs, dt=0.01 hrs, 3601 points

Runoff by SCS TR-20 method, UH=SCS

Reach routing by Stor-Ind+Trans method - Pond routing by Stor-Ind method

**Subcatchment 1S: 1S**

Runoff Area=0.361 ac 74.24% Impervious Runoff Depth=3.80"

Tc=5.0 min CN=92 Runoff=1.59 cfs 0.114 af

**Pond 1P: UDSF**

Peak Elev=30.71' Storage=1,740 cf Inflow=1.59 cfs 0.114 af

Primary=0.86 cfs 0.114 af Secondary=0.00 cfs 0.000 af Outflow=0.86 cfs 0.114 af

**Total Runoff Area = 0.361 ac Runoff Volume = 0.114 af Average Runoff Depth = 3.80"**  
**25.76% Pervious = 0.093 ac 74.24% Impervious = 0.268 ac**

# **Exhibit 7**

---

## **Lighting Specifications**

TYPE:

CATALOG #:

McGraw-Edison®

DESCRIPTION

The McGraw-Edison Concourse III is the most versatile, functionally designed, universally adaptable outdoor lighting luminaire available. Through a variety of mounting styles, it offers a family of low profile sharp-cutoff luminaires that make optimum use of today's high output HID sources.

APPLICATION

Enhancing natural landscapes as well as cityscapes, the Concourse III brings outstanding performance and style to walkways, parking lots, roadways, loading docks, building areas, and any security lighting application. U.L. listed and CSA certified for wet locations.

SPECIFICATION FEATURES

A...Latches

Two spring-steel quick release latches on housing for toolless entry.

B...Socket

Porcelain mogul-base screw shell type lamp socket with spring-loaded center contact.

C...Housing

One-piece, die-cast aluminum housing features aesthetically pleasing soft-corner design.

D...Gasketing

Closed cell gas-filled high temperature silicone gasketing completely seals optical system from dirt, bugs or other foreign material.

E...Lens

Thermal shock- and impact-resistant clear tempered glass.

F...Optics

Optional high efficiency segmented or hydroformed reflectors available in a range of distributions. Reflector modules attach to the housing. All reflectors are field rotatable in 90° increments.<sup>(B)</sup>

G...Mounting

Universal mounting clamp concealed in housing fits 1 1/2" to 2 3/8" O.D. horizontal tenons without adapters. Provides a +5° vertical leveling adjustment.

H...Ballast

Easily removable high power factor HID multi-tap ballast is standard.

J...Hinges

Integral hinges prevent door rocking and optimize sealing capabilities.

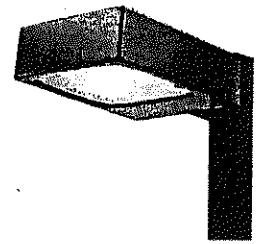

CAL CONCOURSE III

70 - 400 W

High Pressure Sodium Metal Halide

ARCHITECTURAL AREA LUMINAIRE

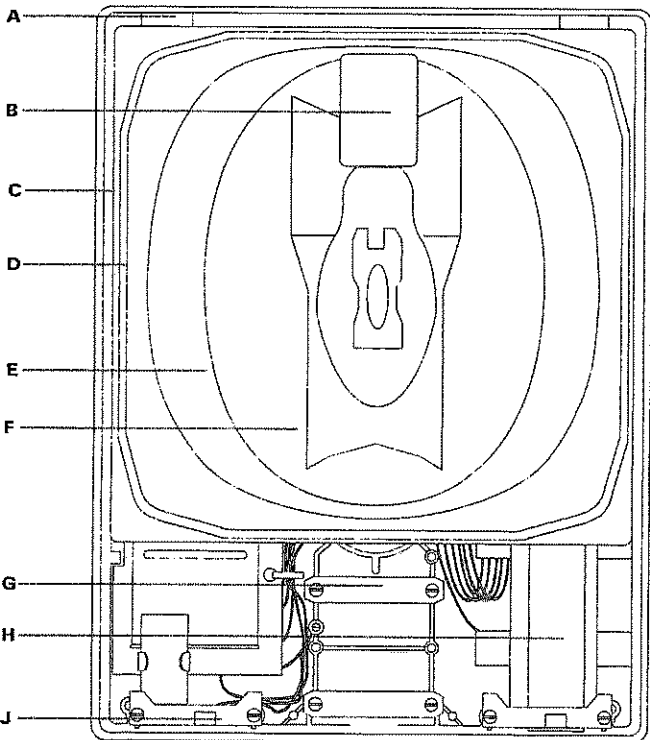

DIRECT ARM MOUNTINGS

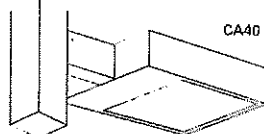
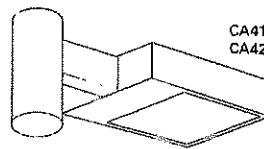

WALL MOUNT ADAPTER

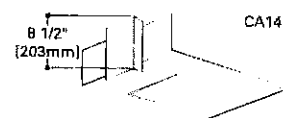

Change

DIMENSIONS

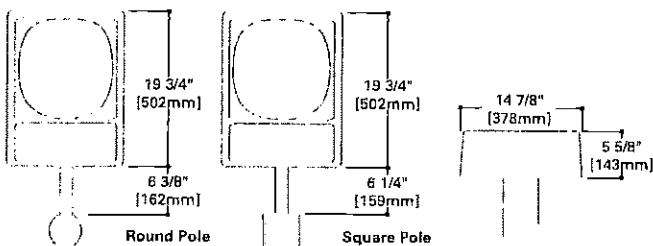

ENERGY DATA

- Hi-Reactance Ballast Input Watts
- 70W HPS HPF (95 Watts)
- 70W MH HPF (94 Watts)
- 100W HPS HPF (130 Watts)
- 100W MH HPF (129 Watts)
- CWA Ballast Input Watts
- 150W MH HPF (210 Watts)
- 175W MH HPF (210 Watts)
- 250W HPS HPF (300 Watts)
- 250W MH HPF (295 Watts)
- 400W HPS HPF (465 Watts)
- 400W MH HPF (455 Watts)

EPA

Effective Projected Area: 0.9

SHIPPING DATA

Approximate Net Weight: 39 lbs. (18 kgs.)

PHOTOMETRICS

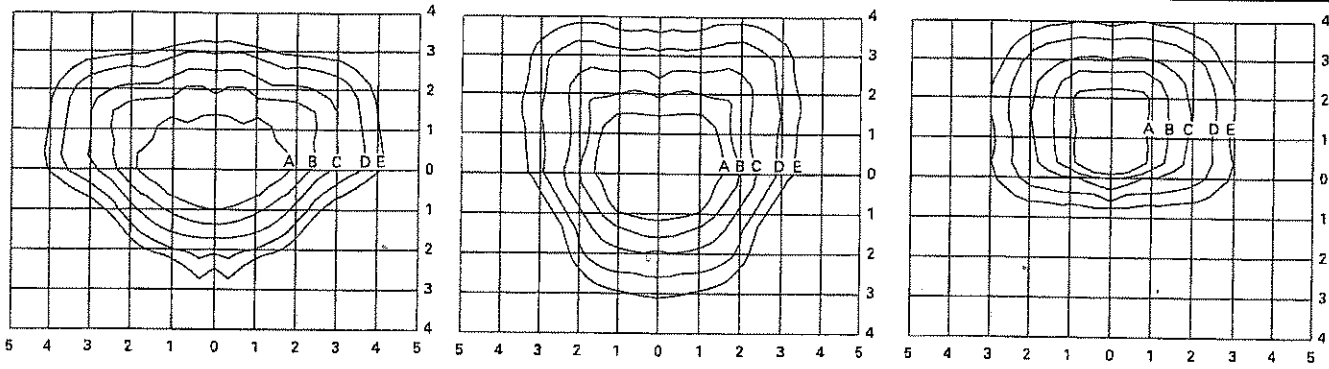

**CAL-400-MH-MT-3S**  
400-Watt MH Type III Segmented  
40,000-Lumen Clear Lamp

**CAL-400-MH-MT-4S**  
400-Watt MH Type IV Segmented  
40,000-Lumen Clear Lamp

**CAL-400-MH-MT-SL**  
400-Watt MH Forward Throw Spill Light Eliminator  
40,000-Lumen Clear Lamp

**Footcandle Table**

Select mounting height and read across for footcandle values of each isofootcandle line. Distance in units of mounting height.

Mounting Height	Footcandle Values for Isofootcandle Lines				
	A	B	C	D	E
20'	3.00	1.50	0.75	0.30	0.15
25'	2.00	1.00	0.50	0.20	0.10
30'	1.38	0.69	0.34	0.13	0.08

**Top Mounting for Square and Round Poles (order separately)**

Accommodates 2 3/8"–3" O.D. vertical tenons (arm included). Catalog number includes slipfitter and mounting arm(s). Square unit height is 6 1/4". Round unit height is 6 3/4".

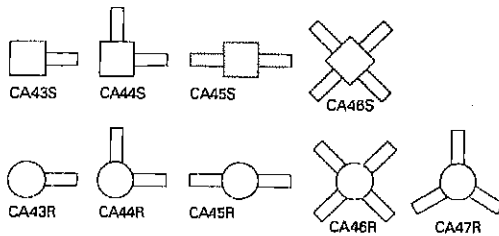

Catalog Number	E.P.A.	Wt. (lbs.)
CA43S	1.2	39
CA44S	2.3	75
CA45S	2.3	75
CA46S	2.3	146
CA43R	1.2	39
CA44R	2.3	75
CA45R	2.3	75
CA46R	2.3	145
CA47R	2.4	111

ORDERING INFORMATION

SAMPLE NUMBER: CAL-400-MH-MT-SL-BZ

<p><b>Product Family</b> CAL=Concourse III</p> <p><b>Lamp Wattage</b> 70=70 100=100W 150=150W 175=175W 250=250W 400=400W*</p>	<p><b>Lamp Type</b> MH=Metal Halide HPS=high Pressure Sodium</p>	<p><b>Voltage</b><sup>1</sup> 120 208 240 277 480 TT=Triple-Tap* MT=Multi-Tap*</p>	<p><b>Optics</b> 2F=Design 20 Formed 2S=Segmented Type II 3F=Design 30 Formed 3S=Segmented Type III 4F=Design 40 Formed 4S=Segmented Type IV* 5F=Design 50 Formed 5S=Segmented Type V SL=Forward Throw Spill Light Eliminator</p>	<p><b>Options (add as suffix)</b><sup>4</sup> F=Single Fuse (120, 277 or 347V) FF=Double Fuse (208, 240 or 480V) Q=Quartz Restrike (limit to 150W maximum, quartz lamp only. Lamp not included.)<sup>7</sup> P=Button Type Photocontrol (Specify Voltage) R=NEMA Twistlock Photocontrol Receptacle V=Vandal Shield HS=House Side Shield* L=Lamp Included</p> <p><b>Colors (add as suffix/must specify color)</b> BK=Black AP=Grey BZ=Bronze WH=White DP=Dark Platinum GM=Graphite Metallic</p>	<p><b>Accessories (order separately)</b> CA1A-XX=Wall Mount Adapter* CA1B=House Side Shield—Design 40 MA1055=House Side Shield (Type 2F &amp; 3F only) CA40-XX=Direct Arm Mount for Square Pole (EPA 0.2)* CA41-XX=Direct Arm Mount for 3" O.D. Round Pole (EPA 0.2)* CA42-XX=Direct Arm Mount for 3 1/2"-4" O.D. Round Pole (EPA 0.2)* CA43S-XX=Single Arm Tenon Adapter for 2 3/8"-3" O.D. Tenon Square Pole CA43R-XX=Single Arm Tenon Adapter for 2 3/8"-3" O.D. Tenon Round Pole CA44S-XX=2 @ 90° Arm Tenon Adapter for 2 3/8"-3" O.D. Tenon Square Pole CA44R-XX=2 @ 90° Arm Tenon Adapter for 2 3/8"-3" O.D. Tenon Round Pole CA45S-XX=2 @ 180° Arm Tenon Adapter for 2 3/8"-3" O.D. Tenon Square Pole CA45R-XX=2 @ 180° Arm Tenon Adapter for 2 3/8"-3" O.D. Tenon Round Pole CA46S-XX=4 @ 90° Arm Tenon Adapter for 2 3/8"-3" O.D. Tenon Square Pole CA46R-XX=4 @ 90° Arm Tenon Adapter for 2 3/8"-3" O.D. Tenon Round Pole CA47S-XX=3 @ 180° Arm Tenon Adapter for 2 3/8"-3" O.D. Tenon Square Pole CA47R-XX=3 @ 180° Arm Tenon Adapter for 2 3/8"-3" O.D. Tenon Round Pole CA9005-XX=Adjustable Fitter, FA55B2 Required (fits 2 3/8" O.D. Vertical Tenon)* OA/RA1016=Photocontrol-Multi-Tap OA/RA1027=Photocontrol-480V OA1046=120V Button Photocontrol for Field Installation OA1047=208/240V Button Photocontrol for Field Installation OA1048=277V Button Photocontrol for Field Installation</p>
---	--	--	---	--	--

NOTES: 1 Bracket arms are not included with standard unit. One bracket arm must be ordered for each standard unit (see Accessories). 2 400W Metal Halide fixtures use E28 lamps only. 3 Products also available in non-US voltages and 50Hz for international markets. Consult factory for availability and ordering information. 4 Multi-Tap ballast is 120/208/240/277V wired 277V. Triple Tap ballast is 120/277/347V wired 347V. 5 Type 4S optic not rotatable with 400W HPS systems. 6 Must be listed in the order shown and separated by a dash. 7 Not available with quartz on "SL" optic. 8 Available for 2S, 3S, 4S, 2F, 3F, 4F distributions only. 9 Add fixture color at end of number. 10 Products also available in non-US voltages and frequencies for international markets. 11 Consult your Cooper Lighting Representative for availability and ordering information.

NOTE: Specifications and dimensions subject to change without notice.

Visit our web site at [www.cooperlighting.com](http://www.cooperlighting.com)

Customer First Center 1121 Highway 74 South Peachtree City, GA 30269 770.486.4800 FAX 770.486.4801 ADH041193

TYPE:

CATALOG #:

**COOPER LIGHTING®**

DETAILS

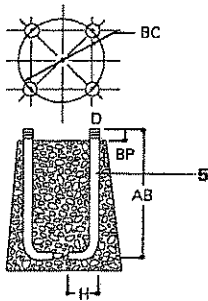
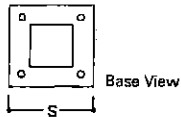
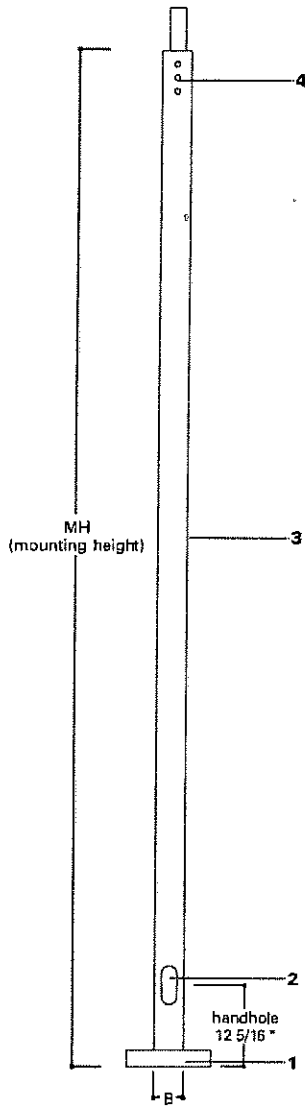

**SPECIFICATION FEATURES**

- 1...ASTM Grade steel base plate with ASTM A366 base cover.
- 2...Hand hole assembly 3" x 5" on 5" end 6" pole; and 2" x 4" on 4" pole.
- 3...ASTM A500 grade "B" steel shaft. Shot blasted and painted with polyester powder coat.
- 4...Drilled or Tenon (specify).
- 5...Anchor bolt per ASTM A576 with (2) nuts, (2) flat washer, and (1) lock washer. Nuts, washers and threaded portion of bolt are hot dip galvanized. 3" hook for 3/4" bolt. 4" hook for 1" bolt.

**FOUR BOLT ANCHORAGE (see ordering information)**

- BC=Bolt Circle
- BP=Bolt Projection
- AB=Bolt Dimensions
- D=Bolt Diameter
- H=Bolt Dimensions

**FINISH COLORS**

- F=Dark Bronze
- G=Galvanized
- V=Grey
- W=White
- Y=Black

**SSSSQUARE STRAIGHT STEEL**

10' - 39'

Mounting Height

SQUARE STRAIGHT STEEL



**ORDERING INFORMATION**

The following information illustrates the correct way to enter an order for SSS5A20SFM1XG. The ordering designation is detailed as follows.

Square	Straight	Steel	Shaft <sup>3</sup> Size	Wall Thickness	Mounting Height (ft.)	Base Type	Finish	Fixture Mounting & Type	No. & Location of Arms	Arm Lengths	Accessories (Ground Lug)
S	S	S	5	A	20	S	F	M	1	X	G

Mtg. Height	Catalog <sup>1,2</sup> Number	Wall Thickness	Base Square (In.)	Bolt Circle Dia. (In.)	Bolt Proj. (In.)	Shaft Size (In.)	Anchor Bolt Dia. & Length (In.)	Net. Wt. (Lbs.)	EPA (Sq. Ft.) <sup>4</sup> At Pole Top				EPA (Sq. Ft.) <sup>4</sup> 2' Above Pole Top				Max. Fixture Load—Include Bracket (Lbs.)
									70	80	90	100	70	80	90	100	
10	SSS4A10SF	.120	10 1/2	11.0	4 1/2	4	3/4 x 25 x 3	96	39.8	29.9	23.2	18.4	33.0	24.8	19.3	15.3	150
15	SSS4A15SF	.120	10 1/2	11.0	4 1/2	4	3/4 x 25 x 3	133	19.6	14.4	10.8	8.2	17.2	12.7	9.5	7.3	150
20	SSS4A20SF	.120	10 1/2	11.0	4 1/2	4	3/4 x 25 x 3	152	12.9	9.1	6.5	4.6	11.7	8.2	5.9	4.2	200
25	SSS4A25SF	.120	10 1/2	11.0	4 1/2	4	3/4 x 25 x 3	208	8.7	5.6	3.6	2.1	8.0	5.2	3.3	2.0	200
20	SSS5A20SF	.120	10 1/2	11.0	4 1/2	5	3/4 x 25 x 3	202	21.9	15.7	11.6	8.5	19.9	14.3	10.5	7.7	200
25	SSS5A25SF	.120	10 1/2	11.0	4 1/2	5	3/4 x 25 x 3	248	15.5	10.5	7.2	4.8	14.3	9.8	6.6	4.4	200
30	SSS5A30SF	.120	10 1/2	11.0	4 1/2	5	3/4 x 25 x 3	293	8.2	4.6	2.1	--	7.7	4.3	2.0	--	300
35	SSS5M35SF	.188	10 1/2	11.0	4 1/2	5	3/4 x 25 x 3	480	11.8	7.1	3.8	1.5	11.1	6.6	3.6	1.4	300
25	SSS6A25SF	.120	12 1/2	12.5	5	6	1 x 36 x 4	295	24.1	16.8	12.0	8.5	22.2	15.6	11.1	7.8	200
30	SSS6A30SF	.120	12 1/2	12.5	5	6	1 x 36 x 4	347	14.0	8.7	5.0	2.5	13.1	8.2	4.7	2.3	300
30	SSS6M30SF	.188	12 1/2	12.5	5	6	1 x 36 x 4	505	26.4	18.1	12.5	8.4	24.7	16.9	11.6	7.9	300
35	SSS6M35SF	.188	12 1/2	12.5	5	6	1 x 36 x 4	584	19.7	12.7	7.9	4.4	18.6	12.0	7.5	4.2	300
35	SSS6X35SF	.250	12 1/2	12.5	5	6	1 x 36 x 4	696	28.9	19.7	13.4	8.9	8.7	18.6	12.7	8.4	300
39	SSS6M39SF	.188	12 1/2	12.5	5	6	1 x 36 x 4	647	15.4	9.1	4.8	1.8	14.6	8.7	4.6	1.7	300
39	SSS6X39SF	.250	12 1/2	12.5	5	6	1 x 36 x 4	822	23.5	15.4	9.8	5.7	22.4	14.6	9.3	5.4	300

NOTES: <sup>1</sup> Catalog number includes pole with anchor bolts with double nuts (BEFORE INSTALLING ANCHOR BOLTS MAKE SURE PROPER ANCHOR BOLT TEMPLATE IS OBTAINED FROM COOPER LIGHTING). <sup>2</sup> Tenon size or machining for rectangular arms must be specified. Hand hole is located 180° from single arm. <sup>3</sup> Shaft size, base plate, anchor bolts and projections may vary slightly—all dimensions nominal. <sup>4</sup> EPA's based on shaft properties with wind normal to flat. EPA's calculated using base wind velocity as indicated plus 30% gust factor.

**DRILLING PATTERN**

Type "M"

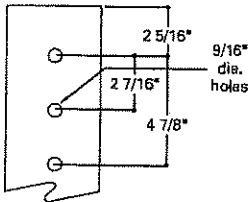

Type "E"

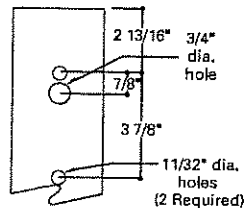

Type "Z"

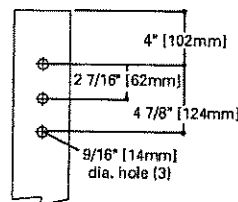

**MOUNTING OPTIONS (add as suffix)**

Fixed Tenon	Designation Number	O.D. (In.)	Length (In.)
	1	2 3/8	3 1/2
	2	2 3/8	4
	3	3 1/2	5
	9	3	4

Type "M" Drill Pattern = Hammer, Landau, Galleria, and Vision Area

Type "E" Drill Pattern = Concourse III

Type "Z" Drill Pattern = Credenza and Cirrus

**MACHINING FOR RECTANGULAR ARMS (add as suffix)**

Designation Letter & Number	Designation (UCS Only) Letter & Number	Designation (Cirrus / Credenza Only) Letter & Number	Quantity & Location
M1	E1	Z1	Single
M2	E2	Z2	2 @ 180°
M3	E3	Z3	3 @ 120°
M4	E4	Z4	4 @ 90°
M5	E5	Z5	2 @ 90°
M8	E6	Z6	3 @ 90°
M7	E7	Z7	2 @ 120°

**ACCESSORIES**

- A=1/2" tapped hub<sup>1</sup>
- B=3/4" tapped hub<sup>1</sup>
- C=Convenience outlet<sup>2</sup>
- G=Grounding lug (max. wire #8 AWG)
- H=Additional hand hole and cover—12" below pole top—90° from hand hole.

NOTES: <sup>1</sup> Location is 3' above base—90° from hand hole, <sup>2</sup> Outlet is located 4' above base and on same side of pole as hand hole, unless specified otherwise. Receptacle not included, provision only.

NOTE: Specifications and dimensions subject to change without notice.

Visit our web site at [www.cooperlighting.com](http://www.cooperlighting.com)

Customer First Center 1121 Highway 74 South Peachtree City, GA 30269 770.486.4800 FAX 770.486.4801 ADH020021





Eyecare Medical Group  
Tomorrow's eyecare today.

FAX COVER SHEET

Date:	7/23
To:	Bill Wilson
From:	Terry Wayne
Dept. or Dr's Office: (See Dr's Fax #s at right)	
Number of pages including cover sheet:	6

Comments: Bill - The price for  
 this light was \$421.00.  
 Included was soft pole and  
 light box. Thanks TW

William S. Holt, M.D.  
(207) 773-0432  
FAX: (207) 874-6755

Elizabeth G. Serrage, M.D.  
(207) 773-4607  
FAX: (207) 874-6755

Bruce R. Cassidy, M.D.  
(207) 773-6058  
FAX: (207) 874-6756

Robert W. Daly, M.D.  
(207) 874-6754  
FAX: (207) 773-1077

Samuel P. Solish, M.D.  
(207) 773-4723  
FAX: (207) 874-6756

Scott M. Steidl, M.D.  
(207) 828-1479  
FAX: (207) 773-1077

Jordan E. Sterrer, M.D.  
(207) 773-4607  
FAX: (207) 874-6755

Ruth E. Stevens, O.D., M.B.A.  
(207) 773-0545  
FAX: (207) 874-2803

Blaine A. Littlefield, O.D.  
(207) 773-0545  
FAX: (207) 874-2803

Clement M. Berry, C.E.O.  
(207) 828-2020  
(207) 874-6752  
FAX: (207) 773-7034

Main Fax  
FAX: (207) 773-7034

Billing Office  
FAX (207) 874-2938

This information has been disclosed to you from records whose confidentiality is protected by state regulations and statute.

State and Federal regulations limit the right to make any further disclosures of this information without prior consent of the patient to whom it pertains.

53 Sewall Street, Portland, Maine 04102-2625  
Telephone: (207) 828-2020 \* Toll-Free: 1-(888)-374-2020  
www.eyecaremed.com

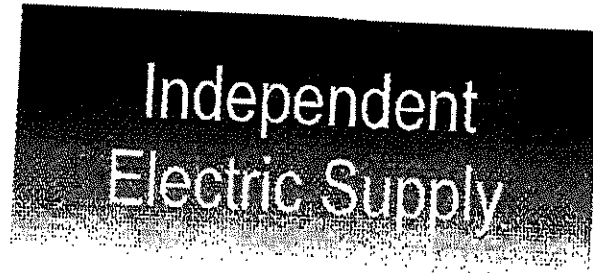

Phone: 207-347-7210

Fax: 207-347-7217

www.iesbuy.com

To: Terry % Eye Care & Surgery

From: JACK MURPHY

Fax: 773-7034

Pages: 5

Phone:

Date: 10-12-2006

Re: 30' Pole and Fixture Cut sheets

CC:

---

Terry,

Cut sheets per Bill Wilson's request attached.

Any questions please call me @ 252-1027 to discuss

Thank you, Jack Murphy

[400 WATT MAX.]

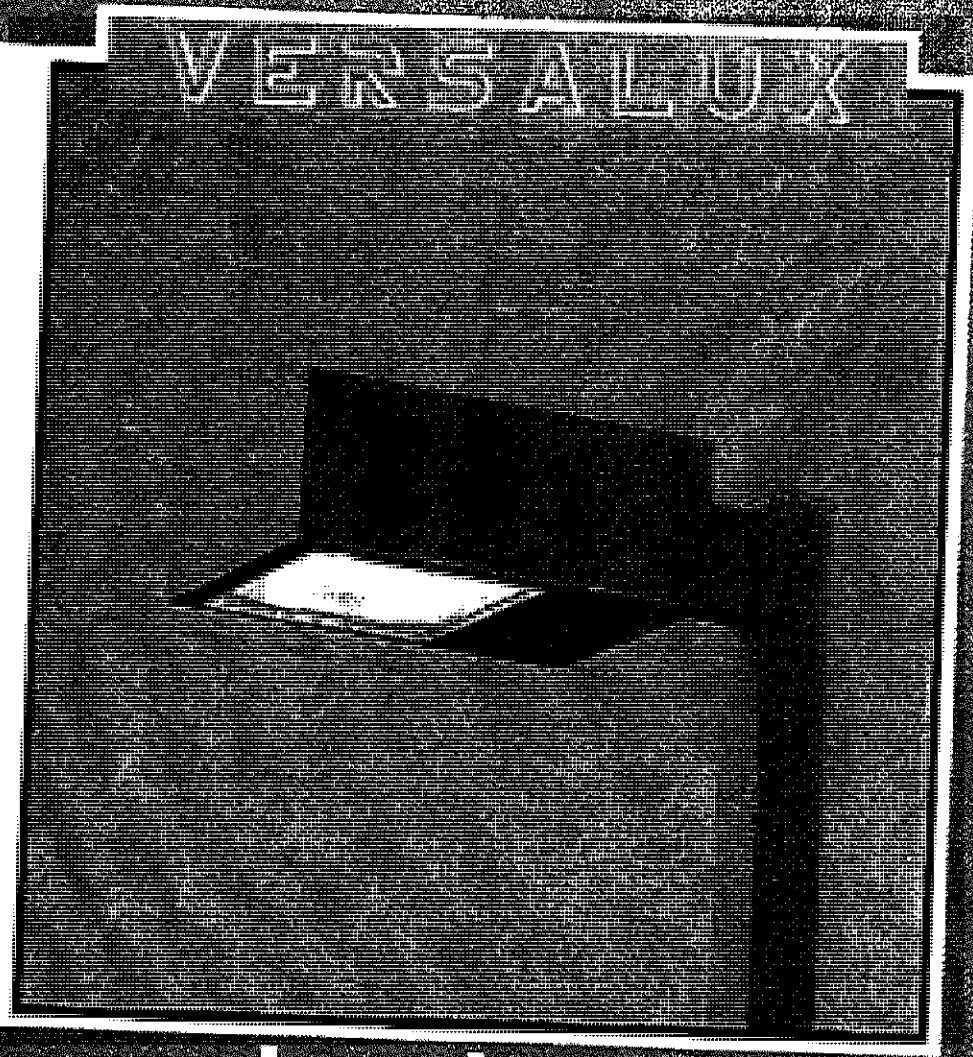
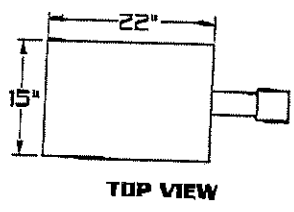
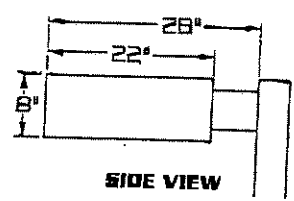

E.P.A.- 1.72



### SPECIFICATIONS

- HOUSING:** ONE PIECE HEAVY GAUGE DIE FORMED ALUMINUM CONSTRUCTION WITH SEPARATE BALLAST COMPARTMENT.
- LENS ASS'Y:** ONE PIECE HINGED HEAVY GAUGE DIE FORMED ALUMINUM OODR FRAME SURROUNDS 3/16" CLEAR TEMPERED GLASS LENS. GLASS IS SEALED TO OODR WITH HIGH TEMPERATURE SILICONE SEAL. TWO CAPTIVE THUMB SCREWS DISENGAGE LENS ASSEMBLY FROM HOUSING WITHOUT THE USE OF TOOLS.
- OPTICS:** COMPUTER DESIGNED ONE PIECE SEMI SPECULAR HYDROFORMED REFLECTOR COMBINES WITH LENS TO PRODUCE A HIGHLY EFFICIENT, SHARP CUTOFF. OPTICS ARE FIELD ROTATABLE.
- GASKETING:** CLOSED CELL EPDM GASKETING COMPRESSED BETWEEN OODR AND HOUSING SEALS OPTICAL CHAMBER.
- LAMP HOLDER:** MDSUL BASE PORCELAIN.
- LAMP:** (BY OTHERS)
- BALLAST:** H.P.F./C.W.A. AUTOTRANSFORMER, -20° STARTING TEMPERATURE. ELECTRICAL COMPONENTS ARE MOUNTED TO HINGED REMOVABLE TRAY FOR EASY ACCESS.
- ARM:** 3"X5"X6" LONG HEAVY WALL EXTRUDED ALUMINUM. ARM IS SECURED TO HOUSING AND TO POLE WITH STAINLESS STEEL RODS.
- FINISH:** POLYESTER POWDER COAT-STATE OF THE ART 20 PSI PRESSURE POWER WASH AT 140° TEMPERATURE INCORPORATES FOUR STEP IRON PHOSPHATE PROCESS TO CLEANSE AND PRETREAT THE METAL SURFACE FOR MAXIMUM PAINT ADHESION. ELECTROSTATICALLY APPLIED TEXTURED POLYESTER POWDER TOP COAT IS BAKED AT 400° TEMPERATURE FOR MAXIMUM HARDNESS AND EXTERIOR DURABILITY.



# SNTS 5"

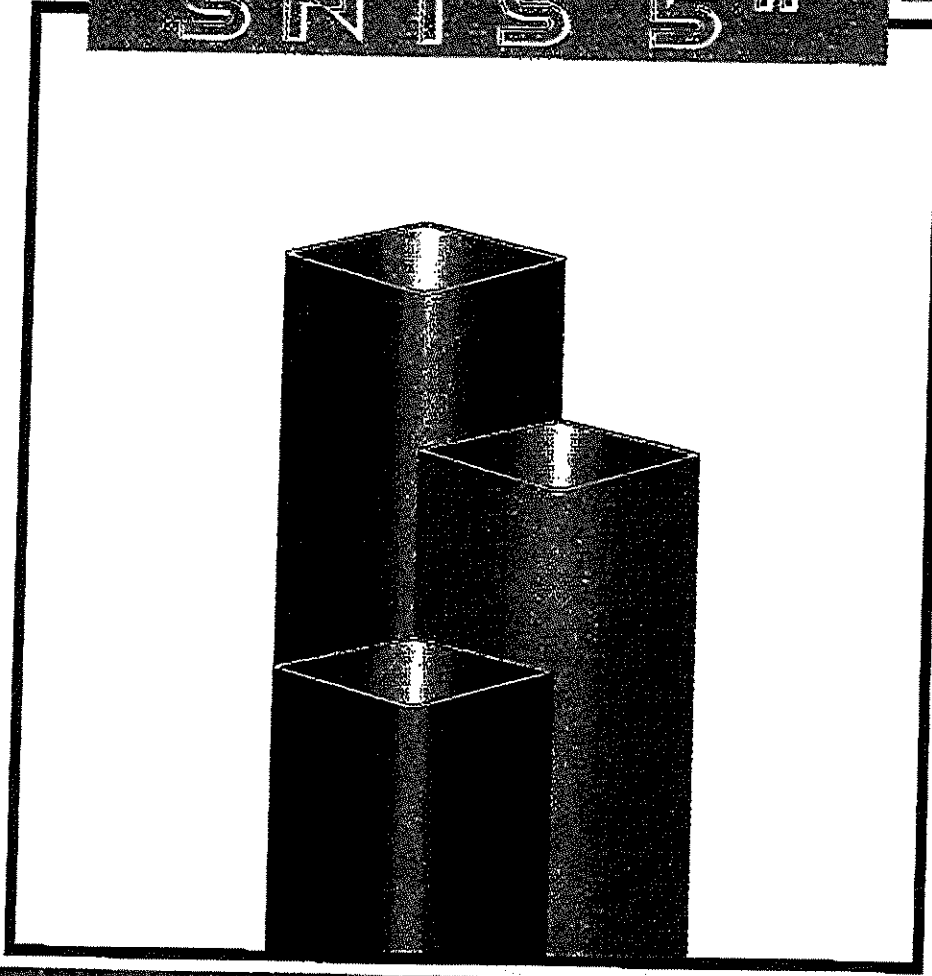
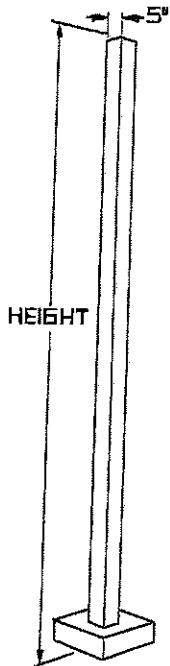

## 5" SQUARE STRAIGHT STEEL

### SPECIFICATIONS

- SHAFT:** 5" SQUARE, FABRICATED FROM HIGH GRADE STRUCTURAL STEEL TUBE. SHAFT CONFORMS TO ASTM-A-501-68 SPECIFICATIONS. MEETS OR EXCEEDS MINIMUM YIELD STRENGTH OF 46,000 P.S.I. WALL THICKNESS 11 GA. (.120 WALL) OR 7 GA. (.180 WALL) AS SPECIFIED. REINFORCED HAND HOLE IS FURNISHED WITH COVER. SHAFT IS FURNISHED WITH GROUND LUG LOCATED INSIDE POLE ON WALL OPPOSITE HAND HOLE.
- BASE PLATE:** FABRICATED FROM STRUCTURAL QUALITY HOT ROLLED STEEL. MEETS OR EXCEEDS MINIMUM YIELD STRENGTH OF 36,000 P.S.I. BASE TELESCOPES AND IS CIRCUMFERENTIALLY WELDED TO POLE SHAFT. SLOTTED BOLT HOLES PROVIDE 1" FLEXIBILITY ON EITHER SIDE OF BOLT CIRCLE CENTERLINE.
- ANCHORAGE:** (4) ANCHOR BOLTS FABRICATED FROM HOT ROLLED STEEL BAR. MINIMUM YIELD STRENGTH OF 50,000 P.S.I. BOLTS HAVE "L" BEND ON ONE END AND ARE THREADED ON THE OTHER END. BOLTS ARE FULLY GALVANIZED AND ARE FURNISHED WITH TWO NUTS AND TWO WASHERS.
- BASE COVER:** FABRICATED FROM HEAVY GAUGE QUALITY CARBON STEEL. TWO PIECE COVER CONCEALS BASE.
- FINISH:** FOUR (4) STAGE FINISH PROCESS IS TOPPED BY TWO (2) COLOR COATS OF ULTRAVIOLET RESISTANT ACRYLIC ENAMEL. THE UNIQUE SURFACE PREPARATION PROCESS INCLUDES TWO (2) CLEANING AND TWO (2) PRIME COATS WHICH PROVIDE A RUST FREE SUBSTRATE PRIOR TO APPLICATION OF THE FINISH COATS.

**TYPICAL SQUARE POLE TEMPLATE**

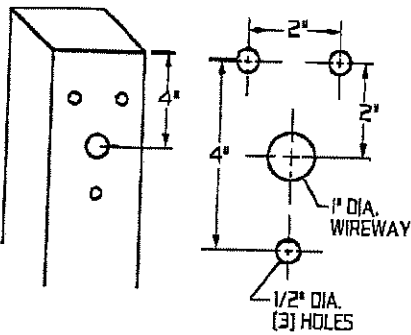

**WALL MOUNT**

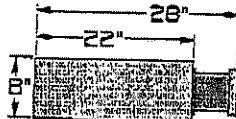
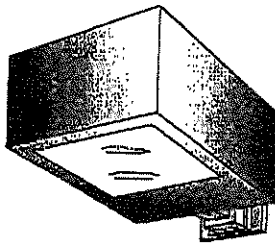

**LAMP SIZE:  
100 - 400 WATT**

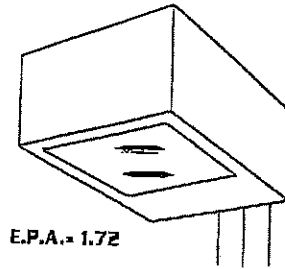

**TYPICAL ROUND POLE TEMPLATE**

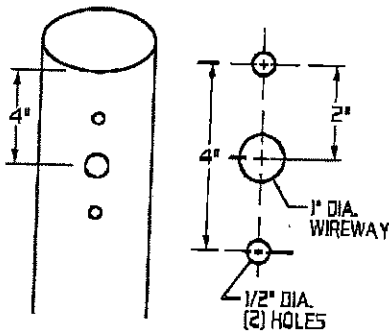

EXTRUDED ALUMINUM ARM AND CAST ALUMINUM WALL BRACKET ASSEMBLY PROVIDED WITH BUILT IN BASKETED WIRE ACCESS FOR FIXTURE/SUPPLY WIRE CONNECTION.

**WALL PLATE**

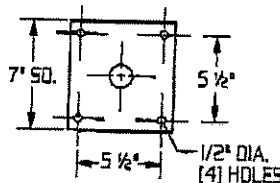

RECTILINEAR HEAVY GAUGE ALUMINUM HOUSING.

FIELD ROTATABLE OPTICS.

FIELD ADJUSTABLE OPTICS, TYPE II AND III LIGHT DISTRIBUTION.

HINGED BALLAST TRAY, WITH QUICK DISCONNECT PLUG FOR EASY ACCESS TO ELECTRICAL COMPONENTS.

TOOLLESS LUMINAIRE ACCESS.

**ORDERING INFORMATION**

MODEL NO.:	OPTICS	WATTAGE TYPE VOLTAGE	MOUNTING	FINISH	OPTIONS
VRS					
MODEL NO.:	OPTICS	LAMP	MOUNTING	FINISH	OPTIONS
VRS	<input type="checkbox"/> TYPE I I..... (hydroform)	WATTAGE TYPE VOLTAGE <input checked="" type="checkbox"/> 400 <input checked="" type="checkbox"/> HPS <input type="checkbox"/> 120 <input type="checkbox"/> 250 <input type="checkbox"/> MH <input type="checkbox"/> 208 <input type="checkbox"/> 200 <input type="checkbox"/> MV <input type="checkbox"/> 240 <input type="checkbox"/> 175 <input type="checkbox"/> 277 <input type="checkbox"/> 150 <input type="checkbox"/> 480 <input type="checkbox"/> 100 <input checked="" type="checkbox"/> MT	ARM MOUNT <input checked="" type="checkbox"/> 1..... STREET LIGHTING ARM MOUNT <input type="checkbox"/> ST23..... (TO FIT OVER 2 3/8" O.D. ARM) ADJUSTABLE KNUCKLE <input type="checkbox"/> NKLE23..... (TO FIT OVER 2 3/8" O.D.) <input type="checkbox"/> NKLE27..... (TO FIT OVER 2 7/8" O.D.) WALL MOUNT <input type="checkbox"/> WM.....	<input checked="" type="checkbox"/> DARK BRONZE DBM <input type="checkbox"/> MEDIUM BRONZE MBM <input type="checkbox"/> BLACK BKM <input type="checkbox"/> WHITE WTM <input type="checkbox"/> SILVER SLM OPTION: <input type="checkbox"/> ANODIZED AZ ANODIZED HOUSING MUST HAVE PAINT FINISH COAT EXAMPLE: AZDBM	<input type="checkbox"/> CLEAR POLYCARBONATE DIFFUSER..... LEX <input type="checkbox"/> HOUSE SIDE SHIELD..... HS <input type="checkbox"/> PHOTO CELL + VOLTAGE (EXAMPLE: PC120V)..... PC+V <input type="checkbox"/> TWIST LOCK PHOTO CELL+VOLTAGE (EXAMPLE TPC120V)..... TPC+V <input type="checkbox"/> TWIST LOCK RECEPTACLE ONLY..... TPR <input type="checkbox"/> SINGLE FUSE (120V., 277V)..... SF <input type="checkbox"/> DOUBLE FUSE (208V., 240V)..... DF <input type="checkbox"/> TAMPER PROOF..... TP
	<input checked="" type="checkbox"/> TYPE II II..... (hydroform)	METAL HALIDE UNITS ONLY USE ED28 LAMP FOR 400 W. USE MEDIUM BASE LAMP FOR 100 W.	SEE ACCESSORIES SECTION FOR ST23 AND NKLE DETAILS	SEE PAGE 3 FOR ADDITIONAL COLORS	
<input type="checkbox"/> TYPE III III..... (hydroform)					
<input checked="" type="checkbox"/> TYPE IV (FORWARD THROW) IV..... (segmented)					
<input type="checkbox"/> TYPE V V-SQ... (segmented)					



# SNTS SERIES

## ENGINEERING DATA

### Maximum EPA - Square Feet

Catalog Number	Maximum Fbct. wgt.	100 MPH	90 MPH	80 MPH	70 MPH
SNTS 185-11	400	10.9	14.5	20.2	27.0
SNTS 205-11	400	8.8	12.0	16.6	23.3
SNTS 205-7	450	15.7	19.2	25.1	31.2
SNTS 255-11	400	5.1	6.5	9.8	14.6
SNTS 255-7	400	9.4	12.4	17.0	23.8
SNTS 305-11	350	N/A	2.8	5.7	7.5
SNTS 305-7	375	5.6	8.7	12.1	18.2
SNTS 355-7	350	2.5	5.2	9.3	14.9

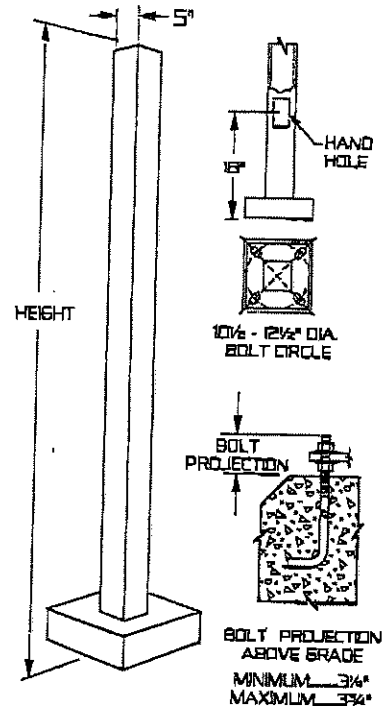

All above design calculations are based on sustained wind forces plus additional 1.3 wind gust  
 (Example: Pole rated at 80 MPH withstands 104 MPH gusts)

## ORDERING INFORMATION

MODEL NO. : SNTS	POLES				MOUNTING		FINISH	OPTIONS
MODEL NO. : SNTS	POLES				MOUNTING		FINISH	OPTIONS
<b>SNTS</b>	<input type="checkbox"/> 185-11	18'	11	1 1/2"	1"X36"X4"	<input type="checkbox"/> 2 3/8"X4" TENON PT23	<input checked="" type="checkbox"/> DARK BRONZE DBM	<input type="checkbox"/> DUPLEX RECEPTACLE DUP
	<input type="checkbox"/> 205-11	20'	11	1 1/2"	1"X36"X4"	<input type="checkbox"/> 2 7/8"X4" TENON PT27	<input type="checkbox"/> MEDIUM BRONZE MBM	<input type="checkbox"/> GFI RECEPTACLE GFI
	<input type="checkbox"/> 205-7	20'	7	1 1/2"	1"X36"X4"	<input type="checkbox"/> OTHER TENON MT _____	<input type="checkbox"/> BLACK BKM	<input type="checkbox"/> 3 WAY ADAPTER T3120
	<input type="checkbox"/> 255-11	25'	11	1 1/2"	1"X36"X4"	<b>DRILL MOUNT</b>	<input type="checkbox"/> WHITE WTM	<input type="checkbox"/> 1/2" COUPLING CPLN1/2
	<input type="checkbox"/> 255-7	25'	7	1 1/2"	1"X36"X4"	<input checked="" type="checkbox"/> 1"..... <input type="checkbox"/> 3-90.....	<input type="checkbox"/> SILVER SLM	<input type="checkbox"/> 3/4" COUPLING CPLN3/4
	<input checked="" type="checkbox"/> 305-11	30'	11	1 1/2"	1"X36"X4"	<input type="checkbox"/> 2-180.....	<b>OPTION:</b>	<input type="checkbox"/> 2" COUPLING CPLN2
	<input type="checkbox"/> 305-7	30'	7	1 1/2"	1"X36"X4"	<input type="checkbox"/> 4-90.....	<input type="checkbox"/> PRIME PAINT PP	(SPECIFY COUPLING LOCATION)
	<input type="checkbox"/> 355-7	35'	7	1 1/2"	1"X36"X4"	<input type="checkbox"/> 2-90.....	<input type="checkbox"/> GALVANIZED GLV	SEE ACCESSORIES SECTION FOR OTHER OPTIONS.
					<input type="checkbox"/> 3-120.....	<input type="checkbox"/> THERMOSET POLYESTER POWDER PDR		
					3-120 REQUIRES PT27 AND T3120 ADAPTER	SEE PAGE 3 FOR ADDITIONAL COLORS		