

**City of Portland, Maine - Building or Use Permit Application**

389 Congress Street, 04101 Tel: (207) 874-8703, FAX: (207) 8716

Job No: 2012-11-5371-ALTR <i>2012 50084</i>	Date Applied: 11/8/2012	CBL: 182- C-004-001	
Location of Construction: 132 WAYSIDE RD	Owner Name: DIRECT REAL ESTATE HOLDINGS, LLC	Owner Address: 66 PEARL ST PORTLAND, ME 04101	Phone: 207-252-7574
Business Name:	Contractor Name: Rob Wing	Contractor Address: 66 PEARL ST PORTLAND MAINE 04101	Phone: 207-252-7574
Lessee/Buyer's Name:	Phone:	Permit Type: Building	Zone: R-3
Past Use: Single family	Proposed Use: Same - Single family - build an <i>20'x22'</i> attached garage. <i>22'x22'</i>	Cost of Work: \$21,000.00	CEO District:
		Fire Dept: <input checked="" type="checkbox"/> Approved <i>w/conditions per Ct. Wallace</i> <input type="checkbox"/> Denied <input type="checkbox"/> N/A	Inspection: Use Group: <i>R3</i> Type: <i>SB</i> <i>IRC, 2009</i> <i>MUBEC</i> Signature: <i>[Signature]</i>
Proposed Project Description: New Attached Garage <i>20'x22'</i> <i>22'x22'</i>		Permit Activities District (P.A.D.)	
Permit Taken By: Lannie	<b>Zoning Approval</b>		

<ol style="list-style-type: none"> <li>This permit application does not preclude the Applicant(s) from meeting applicable State and Federal Rules.</li> <li>Building Permits do not include septic or electrical work.</li> <li>Building permits are void within six (6) months of the date of issuance. False information may invalidate a permit and stop all work.</li> </ol>	<p><i>CLOSED</i></p> <p><i>NO PERMITS</i></p> <p><i>11/2 ARM</i></p>	<b>Zoning Appeal</b> <input type="checkbox"/> Variance <input type="checkbox"/> Miscellaneous <input type="checkbox"/> Conditional Use <input type="checkbox"/> Interpretation <input type="checkbox"/> Approved <input type="checkbox"/> Denied  Date:	<b>Historic Preservation</b> <input checked="" type="checkbox"/> Not in Dist or Landmark <input type="checkbox"/> Does not Require Review <input type="checkbox"/> Requires Review <input type="checkbox"/> Approved <input type="checkbox"/> Approved w/Conditions <input type="checkbox"/> Denied  Date: <i>ARM</i>
	<b>CERTIFICATION</b>		

I hereby certify that I am the owner of record of the named property, or that the proposed work is authorized by the owner of record and that I have been authorized by the owner to make this application as his authorized agent and I agree to conform to all applicable laws of this jurisdiction. In addition, if a permit for work described in the application is issued, I certify that the code official's authorized representative shall have the authority to enter all areas covered by such permit at any reasonable hour to enforce the provision of the code(s) applicable to such permit.

SIGNATURE OF APPLICANT	ADDRESS	DATE	PHONE
RESPONSIBLE PERSON IN CHARGE OF WORK, TITLE		DATE	PHONE

12-7-12

GF

F-D-OK  
SET BACK-OK

595-8325

Gary Works

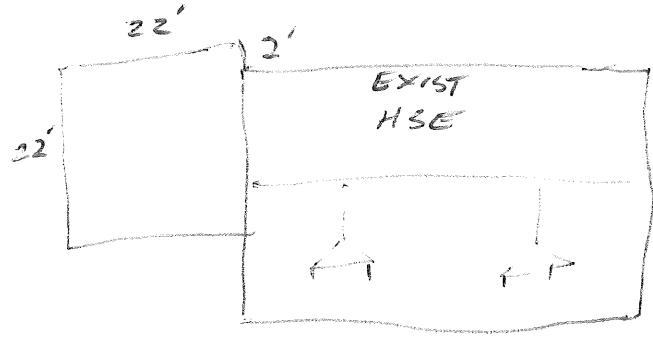

DISPLAY THIS CARD ON PRINCIPAL FRONTAGE OF WORK



# CITY OF PORTLAND

# BUILDING PERMIT

This is to certify that Direct Real Estate Holding, LLC

Located At 132 WAYSIDE RD

Job ID: 2012-11-5371-ALTR

CBL: 182- C-004-001

has permission for an addition of 22' by 22' attached garage (Single Family Residence).

provided that the person or persons, firm or corporation accepting this permit shall comply with all of the provisions of the Statutes of Maine and of the Ordinances of the City of Portland regulating the construction, maintenance and use of the buildings and structures, and of the application on file in the department.

Notification of inspection and written permission procured before this building or part thereof is lathed or otherwise closed-in. 48 HOUR NOTICE IS REQUIRED.

A final inspection must be completed by owner before this building or part thereof is occupied. If a certificate of occupancy is required, it must be

12/05/2012

\_\_\_\_\_  
**Fire Prevention Officer**

\_\_\_\_\_  
**Code Enforcement Officer / Plan Reviewer**

THIS CARD MUST BE POSTED ON THE STREET SIDE OF THE PROPERTY  
PENALTY FOR REMOVING THIS CARD

SCANNED



# PORTLAND MAINE

*Strengthening a Remarkable City. Building a Community for Life* • [www.portlandmaine.gov](http://www.portlandmaine.gov)

Director of Planning and Urban Development  
Jeff Levine

Job ID: 2012-11-5371-ALTR

Located At: 132 WAYSIDE RD

CBL: 182- C-004-001

## **Conditions of Approval:**

### **Zoning**

1. This permit is being approved on the basis of plans submitted. Any deviations shall require a separate approval before starting that work.
2. As discussed during the review process, the property must be clearly identified prior to pouring concrete and compliance with the required setbacks must be established. Due to the proximity of the setbacks of the proposed addition, it may be required to be located by a surveyor.
3. This property shall remain a single family dwelling. Any change of use shall require a separate permit application for review and approval.

### **Building**

1. Separate permits are required for any electrical: plumbing, sprinkler, fire alarm, HVAC systems, commercial hood exhaust systems and fuel tanks. Separate plans may need to be submitted for approval as a part of this process.
2. Frost protection must be installed per the enclosed detail as discussed w/owner/contractor (at least 4' from grade).
3. Section R317 Protection of Wood and Wood Based Products against decay. All wood framing members that rest on concrete or masonry exterior foundation walls and are less than 8 inches from the exposed ground.
4. A graspable handrail (34-38 inches in height) shall be provided on at least one side of each continuous run of treads or flight with four or more risers. Fall protection (36 inches) from exterior decks may be required if floor joist are at or above thirty (30) inches from grade.
5. R807.1 Attic access. Buildings with combustible ceiling or roof construction shall have an attic access opening to attic areas that exceed 30 square feet and have a vertical height of 30 inches or greater. The vertical height shall be measured from the top of the ceiling framing members to the underside of the roof framing members. The rough-framed opening shall not be less than 22 inches by 30 inches and shall be located in a hallway or other readily accessible location.

6. The door opening between the garage and residence shall be equipped with solid wood doors not less than 1 3/8" inches in thickness, solid or honeycomb core steel doors not less than 1 3/8 inches thick, or 20-minute fire-rated doors.
7. Note: Submit specifications for engineered trusses & beams to this office prior to construction.

**TABLE R302.6  
DWELLING/GARAGE SEPARATION**

SEPARATION	MATERIAL
From the residence and attics	Not less than 1/2 inch gypsum board or equivalent applied to the garage side
From all habitable rooms above the garage	Not less than 5/8-inch Type X gypsum board or equivalent
Structure(s) supporting floor/ceiling assemblies used for separation required by this section	Not less than 1/2 inch gypsum board or equivalent
Garages located less than 3 feet from a dwelling unit on the same lot	Not less than 1/2-inch gypsum board or equivalent applied to the interior side of exterior walls that are within this area

For SI: 1 inch = 25.4 mm, 1 foot = 304.8 mm.

Job ID: 2012-11-5371-ALTR

132 Wayside Rd

## **Fire**

1. This permit is to build an attached garage only. No interior renovations or additional living space.
2. A sprinkler system is not required with this scope of work.
3. A final fire inspection is not required.

2012-11-5371 Lanna



# General Building Permit Application

If you or the property owner owes real estate or personal property taxes or user charges on any property within the City, payment arrangements must be made before permits of any kind are accepted.

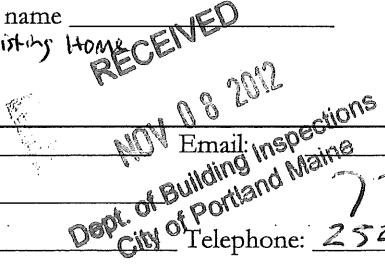
Location/Address of Construction: <u>132 Wayside Rd</u>		
Total Square Footage of Proposed Structure/Area	Square Footage of Lot <u>80/100</u>	Number of Stories
Tax Assessor's Chart, Block & Lot Chart# <u>182</u> Block# <u>C</u> Lot# <u>Y</u>	Applicant: (must be owner, lessee or buyer) Name Address City, State & Zip	Telephone: <u>252-7574</u>  <u>21,000</u>
Lessee/DBA	Owner: (if different from applicant) Name <u>Direct Real Estate Holdings LLC</u> Address <u>66 Pearl St</u> City, State & Zip <u>Portland 04101</u>	Cost of Work: <u>\$20,900.00</u> C of O Fee: \$ Historic Review: \$ Planning Amin.: \$ Total Fee: \$ <u>230-</u>
Current legal use (i.e. single family) <u>single family home</u> Number of Residential Units _____ If vacant, what was the previous use? _____ Proposed Specific use: _____ Is property part of a subdivision? <u>No</u> If yes, please name _____ Project description: <u>New Garage To Be Built on corner of Existing Home 22' x 22'</u>		
Contractor's name: <u>Direct Realty</u> Address: <u>66 pearl st apt 321</u> City, State & Zip: <u>Portland ME</u>		<div style="text-align: right;">             Email: _____            Telephone: <u>775-0333</u>  <u>252 7574</u>  <u>207-4503893</u> </div>
Who should we contact when the permit is ready: <u>Rob Wang</u>		Telephone: <u>252 7574</u>
Mailing address: <u>66 pearl ST suit 321</u>		

Please submit all of the information outlined on the applicable checklist. Failure to do so will result in the automatic denial of your permit.

In order to be sure the City fully understands the full scope of the project, the Planning and Development Department may request additional information prior to the issuance of a permit. For further information or to download copies of this form and other applications visit the Inspections Division on-line at [www.portlandmaine.gov](http://www.portlandmaine.gov), or stop by the Inspections Division office, room 315 City Hall or call 874-8703.

and I hereby certify that I am the Owner of record of the named property, or that the owner of record authorizes the proposed work and that I have been authorized by the owner to make this application as his/her authorized agent. I agree to conform to all applicable laws of this jurisdiction. In addition, if a permit for work described in this application is issued, I certify that the Code Official's authorized representative shall have the authority to enter all areas covered by this permit at any reasonable hour to enforce the provisions of the codes applicable to this permit.

Signature: [Signature] Date: 11-8-12

This is not a permit; you may not commence ANY work until the permit is issued

THIS IS NOT A BOUNDARY SURVEY

This copyrighted document expires 02-02-13. Reproduction and/or dissemination after this date is unauthorized.

MORTGAGE INSPECTION OF: DEED BOOK 458 PAGE 165 COUNTY Cumberland  
 PLAN BOOK 58 PAGE 9 LOT 54

ADDRESS: 132 Wayside Road, Portland, Maine

Job Number: 760-63

Inspection Date: 11-02-12

Owner: Direct Real Estate Holdings, LLC

Scale: 1" = 20'

*R-3*  
 lot size - 8003.  
 front - 25' min - 31' actual *(OK)*  
 rear - 25' min - 26' actual *(OK)*  
 side - 1 or 1 1/2 stories - 8' - 11' 5" min *(OK)*  
 lot coverage - 35% = 2801.05 sq ft

existing 1048  
 proposed 4400 sq ft *(OK)*  
 153 *(OK)*

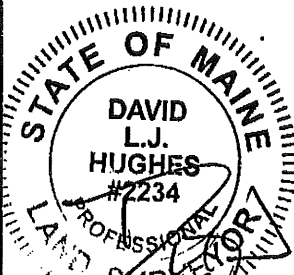
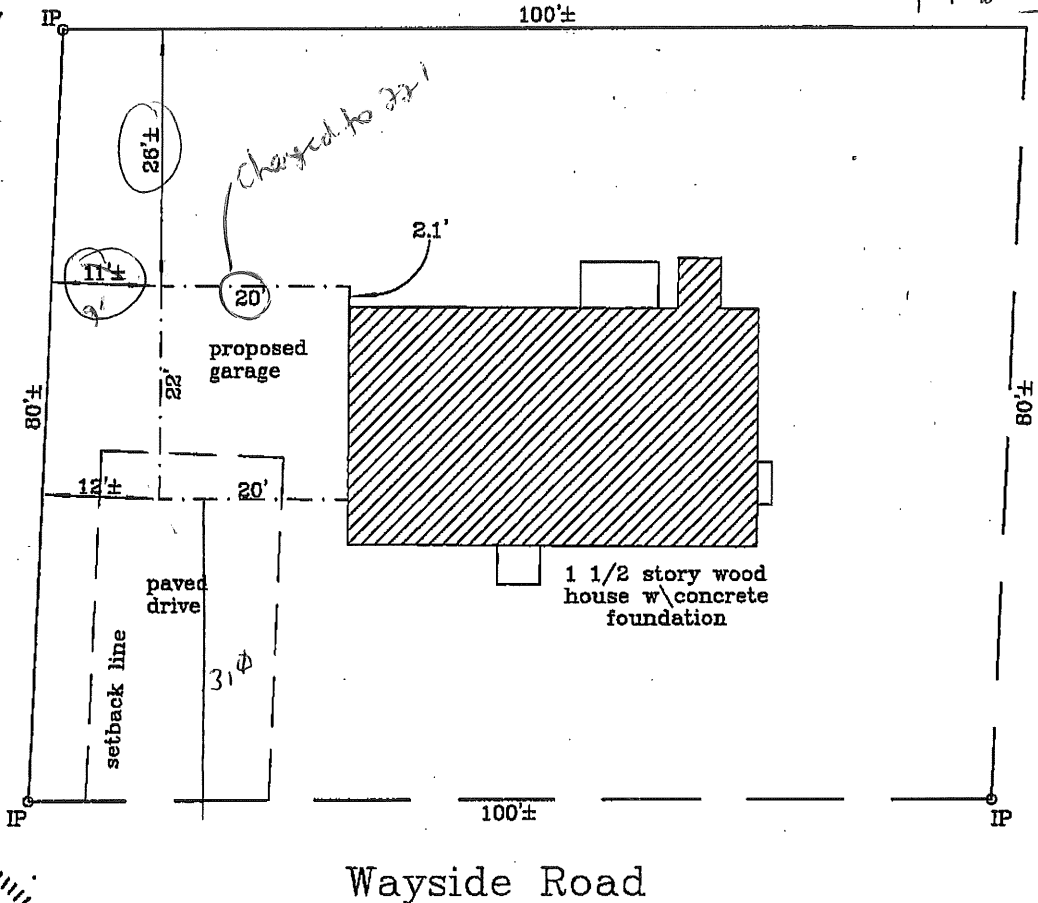
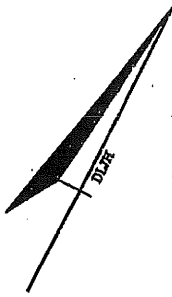

I HEREBY CERTIFY TO: Gordon Holmes, Direct Real Estate Holdings LLC., and its title insurer.

- Monuments found did not conflict with the deed description.
- The dwelling setbacks do not violate town zoning requirements.
- As delineated on the Federal Emergency Management Agency Community Panel 230051 0006C:
- The structure does not fall within the special flood hazard zone.
- The land does not fall within the special flood hazard zone.
- A wetlands study has not been performed.

APPARENT EASEMENTS AND RIGHTS OF WAY ARE SHOWN. OTHER ENCUMBRANCES, RECORDED OR NOT, MAY EXIST. THIS SKETCH WILL NOT REVEAL ABUTTING DEED CONFLICTS, IF ANY.

**Livingston-Hughes**  
 Professional Land Surveyors  
 88 Guinea Road  
 Kennebunkport, Maine 04046  
 207-967-9761 phone      207-967-4831 fax  
 www.livingstonhughes.com

THIS SKETCH IS FOR MORTGAGE PURPOSES ONLY



**STATUTORY WARRANTY DEED**  
(Maine Statutory Short Form)

ABRAHAM V. BENJAMEN, of the City of Portland, County of Cumberland and State of Maine

For Consideration Paid, GRANTS with WARRANTY COVENANTS TO:

DIRECT REAL ESTATE HOLDINGS, LLC, a Maine Limited Liability Company, with a mailing address of 66 Pearl Street, Portland, Maine 04101

the following described real property situated in the City of Portland, Cumberland County, Maine:

A certain lot or parcel of land with the buildings thereon, situated on the northerly side of Wayside Road, in the City of Portland, County of Cumberland, and State of Maine, being Lot 54 as shown on a Plan of Property in Longfellow Woods, Section D, recorded in the Cumberland County Registry of Deeds in Plan Book 58, Page 9, to which plan reference is made for a more complete description.

This conveyance is made SUBJECT to the current real estate taxes to the City of Portland subject to proration at the closing, which the Grantee herein by acceptance of this deed hereby assumes and agrees to pay.

Being the same premises conveyed to Abraham V. Benjamen and Judith Benjamen by deed of Joseph M. Barbara and Wilma F. Barbara, dated July 16, 1979, and recorded in the Cumberland County Registry of Deeds in Book 458, Page 165. The said Judith Benjamen having died in Portland, Maine, on January 10, 2006, and the Grantor herein is the surviving joint tenant.

Witness my hand this 28<sup>th</sup> day of September, 2012.

  
\_\_\_\_\_

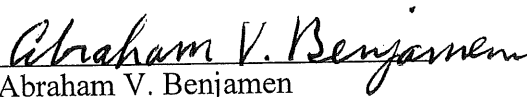
  
Abraham V. Benjamen

THE STATE OF MAINE

Cumberland, ss.

September 28, 2012

Then personally appeared the above-named Abraham V. Benjamen, and acknowledged the foregoing instrument to be his free act and deed.

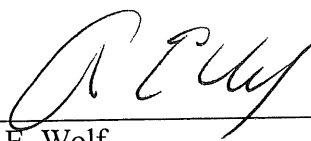
  
\_\_\_\_\_  
Alan E. Wolf  
Attorney at Law, Me Bar. #3453

**A. U.S. Department of Housing and Urban Development**

**B. Type of Loan**

1. <input type="checkbox"/> FHA	2. <input type="checkbox"/> FMHA	3. <input type="checkbox"/> Conv. Unins.
4. <input type="checkbox"/> VA	5. <input type="checkbox"/> Conv. Ins.	
6. File Number 12749		7. Loan Number
8. Mortgage Ins. Case No.		

**Settlement Statement**

**Note:** This form is furnished to give you a statement of actual settlement costs. Amounts paid to and by the settlement agent are shown. Items marked ("POC") were paid outside the closing: they are shown here for information purposes and are not included in the totals.

**Name of Borrower:** Direct Real Estate Holdings, LLC, 66 Pearl Street - Suite 321, Portland, ME 04101

**Name of Seller:** Abraham V. Benjamen, 132 Wayside Road, Portland, ME 04102

**Name of Lender:** Northeast Trading Corp., 28 Woodside Lane, Frerport, ME 04032

**Property Location:** 132 Wayside Road, Portland, ME 04102

**Settlement Agent:** Bay Area Title Services LLC (207) 775-5900

**Place of Settlement:** The Olde Grange Hall at Stroudwater, 1711 Congress Street, Portland, ME 04102

**Settlement Date:** 9/28/2012      **Proration Date:** 9/28/2012

J. Summary of Borrower's Transaction			K. Summary of Seller's Transaction		
<b>0. Gross amount due from borrower:</b>			<b>400. Gross amount due to seller:</b>		
1. Contract sales price	140,000.00		401. Contract sales price		140,000.00
2. Personal property			402. Personal property		
3. Settlement charges to borrower (line 1400)	6,647.00		403.		
4.			404.		
5.			405.		
<b>Adjustments for items paid by seller in advance:</b>			<b>Adjustments for items paid by seller in advance:</b>		
6. City/town taxes 9/28/2012 to 1/1/2013	886.63		406. City/town taxes 9/28/2012 to 1/1/2013		886.63
7. County taxes			407. County taxes		
8. Assessments			408. Assessments		
9.			409.		
0.			410.		
1. Assignment Fee	5,000.00		411.		
2. Funds withheld by lender	12,466.37		412.		
<b>0. Gross amount due from borrower:</b>	<b>165,000.00</b>		<b>420. Gross amount due to seller:</b>		<b>140,886.63</b>
<b>0. Amounts paid by or in behalf of the borrower:</b>			<b>500. Reduction in amount due to seller:</b>		
1. Deposit or earnest money			501. Excess deposit (see instructions)		
2. Principal amount of new loan(s)	175,000.00		502. Settlement charges to seller (line 1400)		333.00
3. Existing loan(s) taken subject to			503. Existing loan(s) taken subject to		
4.			504. Payoff of first mortgage loan		
5.			505. Payoff of second mortgage loan		
6.			506. Maine REW Tax		
7.			507.		
8.			508.		
9.			509.		
<b>Adjustments for items unpaid by seller:</b>			<b>Adjustments for items unpaid by seller:</b>		
10. City/town taxes			510. City/town taxes		
11. County taxes			511. County taxes		
12. Assessments			512. Assessments		
13.			513.		
14.			514.		
15.			515.		
16.			516.		
17.			517.		
18.			518.		
19.			519.		
<b>20. Total paid by/for borrower:</b>	<b>175,000.00</b>		<b>520. Total reduction in amount due seller:</b>		<b>333.00</b>
<b>00. Cash at settlement from/to borrower:</b>			<b>600. Cash at settlement to/from seller:</b>		
01. Gross amount due from borrower (line 120)	165,000.00		601. Gross amount due to seller (line 420)		140,886.63
02. Less amount paid by/for borrower (line 220)	175,000.00		602. Less total reduction in amount due seller(line 520)		333.00
03. <b>CASH (A)FROM (X)TO BORROWER</b>	<b>10,000.00</b>		603. <b>CASH (I)FROM (X)TO SELLER</b>		<b>140,553.63</b>

120. Gross amount due from borrower:	165,000.00	420. Gross amount due to seller:	140,886.63
200. Amounts paid by or in behalf of the borrower:		500. Reduction in amount due to seller:	
201. Deposit or earnest money		501. Excess deposit (see instructions)	
202. Principal amount of new loan(s)	175,000.00	502. Settlement charges to seller (line 1400)	333.00
203. Existing loan(s) taken subject to		503. Existing loan(s) taken subject to	
204.		504. Payoff of first mortgage loan	
205.		505. Payoff of second mortgage loan	
206.		506. Maine REW Tax	
207.		507.	
208.		508.	
209.		509.	
Adjustments for items unpaid by seller:		Adjustments for items unpaid by seller:	
210. City/town taxes		510. City/town taxes	
211. County taxes		511. County taxes	
212. Assessments		512. Assessments	
213.		513.	
214.		514.	
215.		515.	
216.		516.	
217.		517.	
218.		518.	
219.		519.	
220. Total paid by/for borrower:	175,000.00	520. Total reduction in amount due seller:	333.00
300. Cash at settlement from/to borrower:		600. Cash at settlement to/from seller:	
301. Gross amount due from borrower (line 120)	165,000.00	601. Gross amount due to seller (line 420)	140,886.63
302. Less amount paid by/for borrower (line 220)	175,000.00	602. Less total reduction in amount due seller(line 520)	333.00
303. CASH (FROM X) TO BORROWER	10,000.00	603. CASH (FROM X) TO SELLER	140,553.63

**SUBSTITUTE FORM 1099 SELLER STATEMENT** - The information contained in Blocks E, G, H and I and on line 401 (or, if line 401 is asterisked, lines 403 and 404), 406, 407 and 408-412 (applicable part of buyer's real estate tax reportable to the IRS) is important tax information and is being furnished to the Internal Revenue Service. If you are required to file a return, a negligence penalty or other sanction will be imposed on you if this item is required to be reported and the IRS determines that it has not been reported.

**SELLER INSTRUCTION** - If this real estate was your principle residence, file form 2119, Sale or Exchange of Principal Residence, for any gain, with your income tax return; for other transactions, complete the applicable parts of form 4797, Form 6252 and/or Schedule D (Form 1040).

You are required by law to provide Bay Area Title Services LLC (207) 775-5900 with your correct taxpayer identification number.

If you do not provide Bay Area Title Services LLC (207) 775-5900 with your correct taxpayer identification number, you may be subject to civil or criminal penalties.

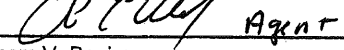
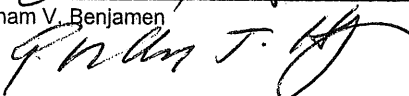
  
 Abraham V. Benjamin  

L. Settlement Charges		9/28/12 1:21 PM	File Number: 12749	
700.	Total sales/broker commission		Paid From	Paid From
	Division of commission (line 700) as follows:		Borrower's	Seller's
701.	\$		Funds at	Funds at
702.	\$		Settlement	Settlement
703.	Commission paid at settlement			
704.				
800.	Items payable in connection with loan			
801.	Loan origination fee to Northeast Trading Corp. (3%)		5,250.00	
802.	Loan discount			
803.	Appraisal fee			
804.	Credit report			
805.	Lender's inspection fee			
806.	Mortgage insurance application fee			
807.	Assumption fee			
808.				
809.				
810.				
811.				
812.				
813.				
814.				
900.	Items required by lender to be paid in advance			
901.	Interest from			
902.	Mortgage insurance premium for			
903.	Hazard insurance premium for			
904.				
905.				
1000.	Reserves deposited with lender			
1001.	Hazard insurance			
1002.	Mortgage insurance			
1003.	City property taxes			
1004.	County property taxes			
1005.	Annual assessments (maint.)			
1006.				
1007.				
1008.	Aggregate Accounting Adjustment			
1009.				
1100.	Title charges			
1101.	Settlement or closing fee to Bay Area Title Services LLC		595.00	
1102.	Abstract or title search			
1103.	Title examination			
1104.	Title insurance binder			
1105.	Document preparation			
1106.	Notary fees			
1107.	Attorney's fees to <i>includes above items no.:</i>			
1108.	Title insurance to Stewart Title Guaranty Company <i>includes above items no.:</i>		420.00	
1109.	Lender's coverage \$175,000.00			
1110.	Owner's coverage \$140,000.00 \$420.00			
1111.				
1112.	Registry Copies			
1113.	REW Transmittal Fee			
1200.	Government recording and transfer charges			
1201.	Recording fees: Deed \$18.00 Mortgage \$56.00		74.00	
1202.	City/county tax/stamps:			
1203.	State tax/stamps: Deed \$616.00		308.00	308.00
1204.				
1205.	Mtge Discharge Compliance Fee			
1206.	Wire/Overnight Payoff to Lender			
1207.	Portland Tax Certification Fee to City of Portland			25.00
1300.	Additional settlement charges			
1301.	Survey			

101.	Hazard insurance			
102.	Mortgage insurance			
103.	City property taxes			
104.	County property taxes			
105.	Annual assessments (maint.)			
106.				
107.				
108.	Aggregate Accounting Adjustment			
109.				
<b>00. Title charges</b>				
01.	Settlement or closing fee	to Bay Area Title Services LLC	595.00	
02.	Abstract or title search			
03.	Title examination			
04.	Title insurance binder			
05.	Document preparation			
06.	Notary fees			
07.	Attorney's fees to			
	<i>includes above items no.:</i>			
108.	Title insurance	to Stewart Title Guaranty Company	420.00	
	<i>includes above items no.:</i>			
109.	Lender's coverage	\$175,000.00		
110.	Owner's coverage	\$140,000.00	\$420.00	
111.				
112.	Registry Copies			
113.	REW Transmittal Fee			
<b>200. Government recording and transfer charges</b>				
201.	Recording fees:	Deed \$18.00 Mortgage \$56.00	74.00	
202.	City/county tax/stamps:			
203.	State tax/stamps:	Deed \$616.00	308.00	308.00
204.				
205.	Mtge Discharge Compliance Fee			
206.	Wire/Overnight Payoff to Lender			
207.	Portland Tax Certification Fee	to City of Portland		25.00
<b>300. Additional settlement charges</b>				
301.	Survey			
302.	Pest inspection			
303.	Overnight Fee for Payoff			
304.	Courier Fee for Documents			
305.	Incoming Wire Fee			
400.	Total settlement charges (entered on lines 103, section J and 502, section K)		6,647.00	333.00

**CERTIFICATION:** I have carefully reviewed the HUD-1 Settlement Statement and to the best of my knowledge and belief, it is a true and accurate statement of all receipts and disbursements made on my account or by me in this transaction. I further certify that I have received a copy of HUD-1 Settlement Statement.

Robert T. [Signature] 9/28/12  
 Director Real Estate Holdings, LLC

Abraham V. Benjamen Agent  
 Abraham V. Benjamen

To the best of my knowledge, the HUD-1 Settlement Statement which I have prepared is a true and accurate account of the funds which were received and have been or will be disbursed by the undersigned as part of the settlement of this transaction.

[Signature]  
 Bay Area Title Services LLC

9/28/12  
 Date

# PROPOSAL / CONTRACT

## Action Electric Inc.

79 Longview Drive, Portland, Maine 04103  
(207) 650-1651 LIC #MS60019031

Date: 11/6/2012

Contract: 1526

"Action Electric Inc.", hereinafter referred to as "Electric Contractor", proposes to furnish material and labor in accordance with the job description identified in this Proposal/Contract pursuant to the following:

1. SUBMITTED TO: Rob Wing, 87 Cumberland Ave. Apt. #2, Portland, Maine 04101
2. JOB PHONES: Phone1: 207-252-7574
3. JOB LOCATION: 132 Wayside Road, Portland Maine
4. PLANS DESCRIPTION:

5. JOB DESCRIPTION: Wire garage being built at 132 Wayside Road.

- (1) 15amp (light circuit) & (1) 20amp (outlet circuit) from existing panel in basement
- (1) outlet for the garage door opener
- (3) convenience outlets in garage(GFI protected)
- (4) porcelain lights in garage with 3-way switching
- (1) motion sensor light outside on single switch(motion sensor light & bulbs included)

Proposal includes Portland electrical permit.

**WE PROPOSE to perform the work as stated in this Contract in accordance with the specifications and plans submitted and completed in a workmanlike manner**

**for the sum of: \$1025.**

**with payments: 1/3 to start, 1/3 after rough-in, final upon completion**

**This Contract is executed in "Portland, Maine" by Electric Contractor**

**ACCEPTANCE OF PROPOSAL: The prices, specifications, terms and conditions are hereby accepted. You are authorized to do the work as specified. Payment will be made as outlined above.**

It is understood and agreed that this work is not provided for in any other agreement and no other contractual rights arise until this proposal is accepted in writing.

Date ..... Signature .....

## TERMS AND CONDITIONS

6. Electrical shall be installed to standards of the National Electric Code and is guaranteed free from short circuits for one year. No other warranties are expressed or implied.
7. Electric Contractor is not responsible or liable in any way, for any part of the existing electrical system.
8. Electric Contractor shall make holes in the building to gain access for routing cables & conduits and shall not be held liable in any way for labor or costs incurred for painting, texturing, repairing walls or ceilings.
9. Time and materials work shall be charged \$55 an hour plus materials. Service calls shall be charged \$75 for the first half-hour, then \$55 per hour. \$75 is minimum charge.
10. Permits, inspections and/or plans required for this work are the responsibility and liability of the party submitted to in section 1.
11. Change orders: Any alteration or deviation from the above specifications involving extra costs will be made only upon written agreement, and will become an extra charge above the contract price to be paid immediately.
12. Delay: Electric Contractor will be excused for any delay beyond our control. These delays may include, but are not limited to Acts of God, labor disputes, inclement weather, acts of owner or public authority, or other unforeseen contingencies.
13. Right to Stop Work: If any payment under this Contract is not made when due, Electric Contractor may stop suspend work until all payments have been made.
14. Any failure to make payments to Electric Contractor is subject to a claim against the property in accordance with applicable lien laws.
15. It is agreed that payment to Electric Contractor shall not be withheld due to any delay or failed payments to the party submitted to in section 1.
16. Malicious mischief and vandalism on the job is the responsibility of the party submitted to in section 1. Electric Contractor shall not be responsible for any damage resulting therefrom. Party submitted to shall carry needed insurance.
17. Overdue accounts will be charged a late charge at the rate of 1.5% per month, or the maximum rate permitted by law, whichever is less.
18. In the event any party to this Contract commences any action, legal or otherwise, to collect the contract price, the prevailing party shall be entitled to recover attorneys fees and all other costs incurred in connection with the action.
19. This Proposal shall be effective for thirty days from the date first set forth above. If this Proposal is not accepted within this time it shall be expired. This Proposal may be withdrawn any time before acceptance.
20. The language of all parts of this Contract shall in all cases be construed as a whole, according to its fair meaning, and not strictly for or against any of the parties. No provision shall be deemed dependant upon any other.
21. If any provision of this Contract is held by an arbitrator or court to be unenforceable, invalid or illegal, said provision shall be deemed to be deleted and shall not affect the validity of the remaining provisions of this contract.
22. Party submitted to shall give written notice of a back charge to Electric Contractor within ten days of the act giving rise to a back charge. If no such notice is given within the ten day period the back charge shall not be allowed.
23. In the event party submitted to does not request work to begin and/or the project is not in good condition to commence the work within 30 days after the acceptance of this Contract, Electric Contractor shall have the option to terminate this Contract.

# Garage proposal

10/31/12

132 wayside Rd      Frame to Finish

Foundation      \$5750.00

Action Electric      \$1025.00

Framing Siding Roofing      14,125.00

all work to be completed in a workmanlike manner

Total 20,900.00

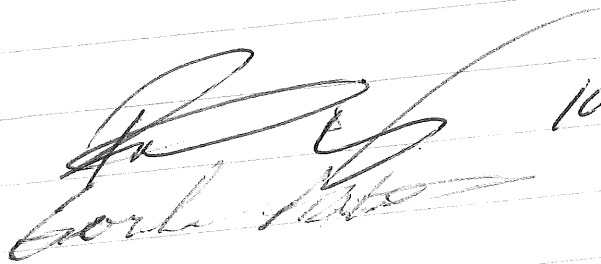

10-31-12

# Framing Plan

Wind

9'  
from studs  
to top  
plate

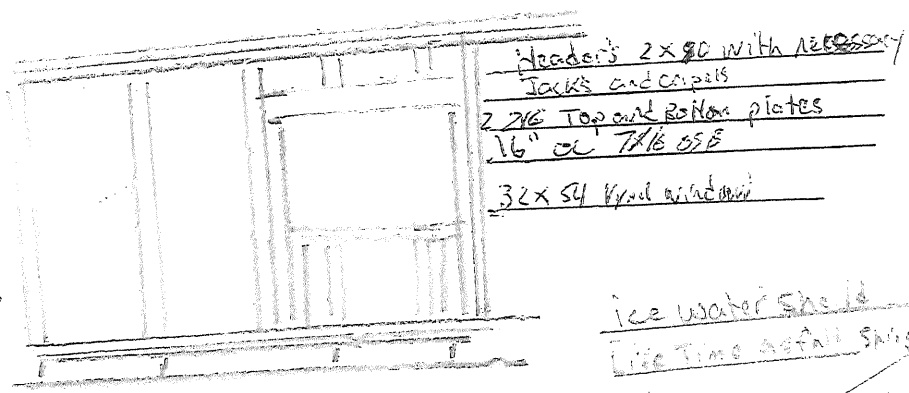

1' Foot over hang

Ice water shield  
Life Time Asphalt Shingles  
8" Alum S/D

5/8 OSB  
On Trusses with 80 psf snow load

Soffit vent  
Trim to match existing  
8" pine fir 3 1/2" on top

2 2x6 Top Plate

Curb head across 24x30

2x6 studs 16" oc

Stair 2x6 @ OC TO SIT ON LVL  
ON TRIP JACKS 15" 10" OPENING

7/16 OSB  
with White Vinyl Siding

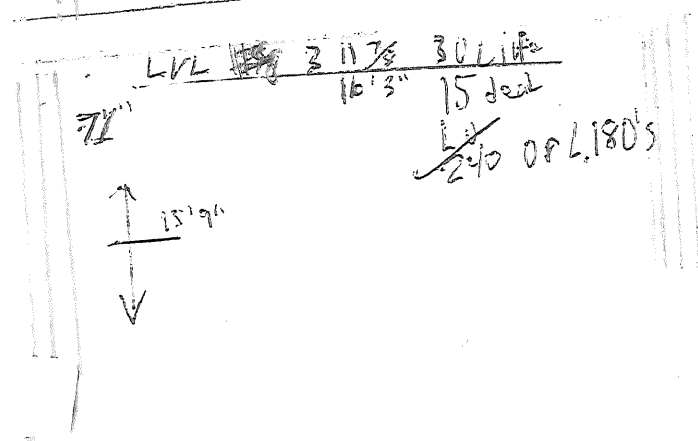

2x6 sit TO BOIS with 5/8 4' OC

8"



Wint

2x6 FT Plate

Slab 6"

1' above grade

5/8 40c

To float

4' Frost wall 18/10 footing

1' above grade

5/8 40c 4' oc 1' to corner

18/10 Footing

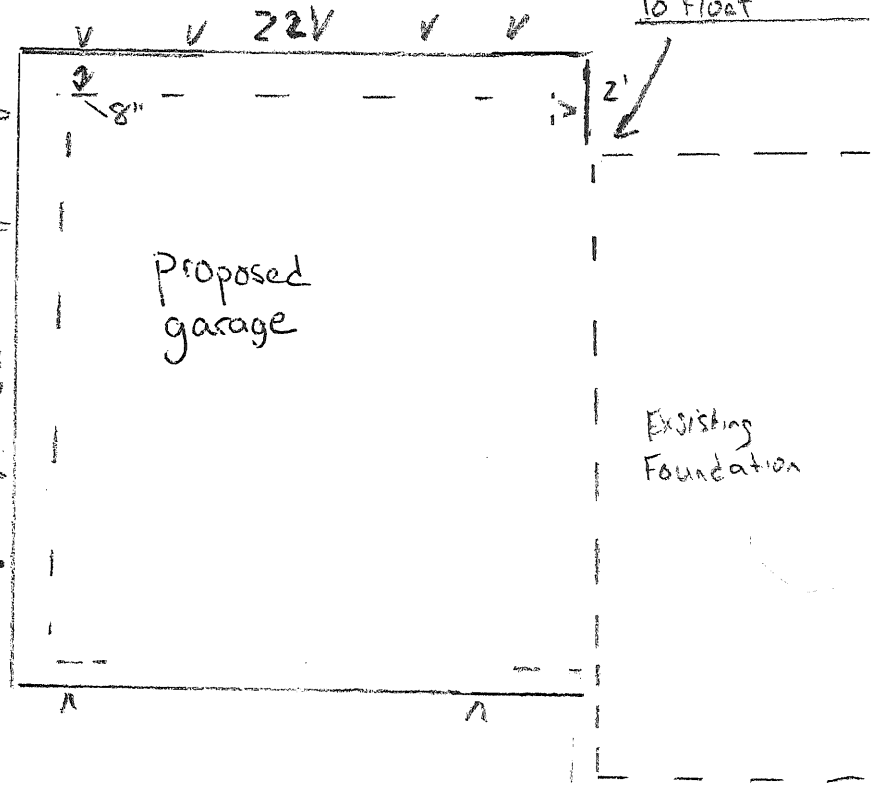

# Framing plane

100 WINDMILL RD  
WIND

Direct Head access  
24 x 30 11' to center from walls  
7' from existing wall

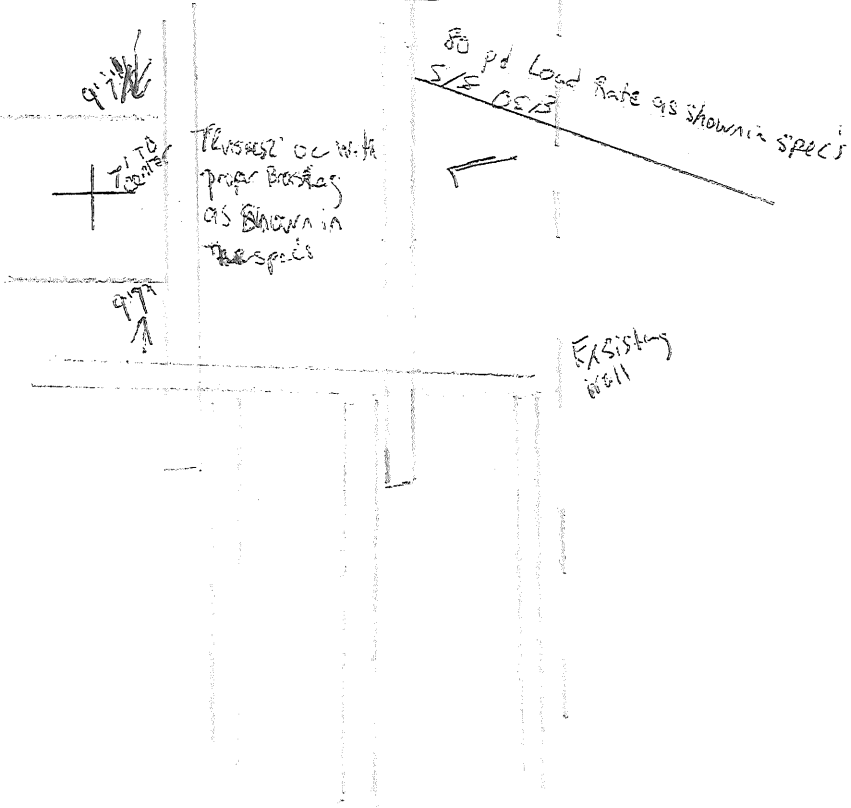

New TD Be Laged TO Existing with  
1/2 AS Lag Bolts

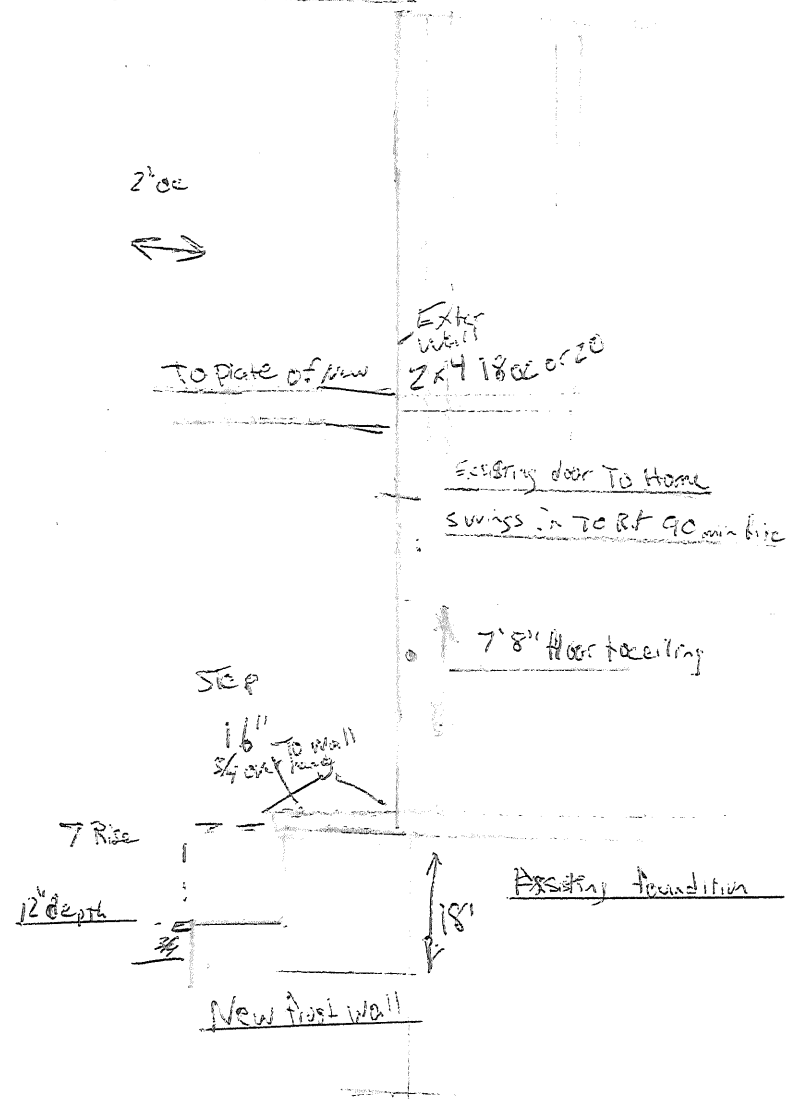

495-1297

132 Wayside Rd

Win 6  
**Hammond**  
Lumber Company

# Take Off Spec List

DATE:	LEAD TIME:	ESTIMATOR
SALES:	KIT. SALES:	FLR. SALES:

CUST/ACCT #		
CLIENT:	HOME PHONE:	JOB LOCATION:
ADDRESS:	WORK PHONE:	START DATE:
CITY/ZIP:	CELL PHONE:	E-MAIL:

BUILDER:	WORK PHONE:	CELL PHONE:
----------	-------------	-------------

## Information

HOUSE SIZE	DAYLIGHT BASEMENT <input type="checkbox"/> YES <input type="checkbox"/> NO	FOUNDATION <input type="checkbox"/> YES <input type="checkbox"/> NO
HOUSE STYLE	FINISHED BASEMENT <input type="checkbox"/> YES <input type="checkbox"/> NO	BULKHEAD <input type="checkbox"/> YES <input type="checkbox"/> NO
GARAGE <input type="checkbox"/> YES <input type="checkbox"/> NO	STYROFOAM <input type="checkbox"/> YES <input type="checkbox"/> NO	ATTIC <input type="checkbox"/> YES <input type="checkbox"/> NO
DRAWING #		DESIGNER

## Framing

SILL PLATE	<input checked="" type="checkbox"/> 2x4	<input type="checkbox"/> 2x6	<input type="checkbox"/> 2x8				NOTES:
FLOOR FRAMING	<input type="checkbox"/> 2x10	<input type="checkbox"/> 2x12	<input type="checkbox"/> I-JOIST	<input type="checkbox"/> TRUSSES			Slab
JOIST BRIDGING	<input type="checkbox"/> WOOD	<input type="checkbox"/> METAL	<input type="checkbox"/> SOLID				NA
SUBFLOOR	<input type="checkbox"/> 3/4 T&G FIR	<input type="checkbox"/> 3/4 T&G ADV	<input type="checkbox"/> 3/4 T&G OSB	<input type="checkbox"/> 3/4 T&G DRY PLY			NA
EXTERIOR WALL STUDS	<input type="checkbox"/> 2X6	<input checked="" type="checkbox"/> 2X4	<input type="checkbox"/> 8 FT	<input type="checkbox"/> 9 FT	<input type="checkbox"/> 10 FT		
GARAGE WALL STUDS	<input type="checkbox"/> 2 X 6	<input checked="" type="checkbox"/> 2 X 4	<input type="checkbox"/> 8 FT	<input type="checkbox"/> 9 FT	<input type="checkbox"/> 10 FT		
WALL SHEATHING	<input type="checkbox"/> 1/2 CDX	<input type="checkbox"/> 1/2 ADV	<input checked="" type="checkbox"/> 7/16 OSB	<input type="checkbox"/> 7/16 ZIP WALL	<input type="checkbox"/> SIS		
CEILING FRAMING	<input type="checkbox"/> 2x6	<input type="checkbox"/> 2x8	<input type="checkbox"/> 2x10				
ROOF FRAMING	<input type="checkbox"/> 2x10	<input type="checkbox"/> 2x12	<input type="checkbox"/> I-JOIST	<input checked="" type="checkbox"/> TRUSSES			

## Roofing

ROOF SHEATHING	<input type="checkbox"/> ZIP ROOF	<input type="checkbox"/> 5/8 CDX	<input type="checkbox"/> 5/8 T&G ADV	<input type="checkbox"/> 5/8 ADV	<input checked="" type="checkbox"/> 5/8 WTG		NOTES:
ROOFING TYPE	<input type="checkbox"/> 3 TAB	<input checked="" type="checkbox"/> ARCHITECTURAL	<input type="checkbox"/> METAL SCREW DOWN	<input type="checkbox"/> STANDING SEAM			
SHINGLE BRAND	<input checked="" type="checkbox"/> CERTAINTEED	<input type="checkbox"/> IKO					
UNDERLAYMENT	<input type="checkbox"/> 15 # FELT	<input type="checkbox"/> 30 # FELT	<input checked="" type="checkbox"/> A1WS <i>Phib</i>	<input type="checkbox"/> RTG			
DRIP EDGE	<input type="checkbox"/> GALVANIZED	<input checked="" type="checkbox"/> ALUMINUM	<input type="checkbox"/> WHITE	<input type="checkbox"/> BROWN	<input type="checkbox"/> RITE FLOW		
RIDGE VENT	<input type="checkbox"/> VENT 2	<input checked="" type="checkbox"/> COBRA VENT	<input type="checkbox"/> LOR30	<input type="checkbox"/> CORAVENT			

## Siding

SIDING	<input checked="" type="checkbox"/> VINYL	<input type="checkbox"/> 4200	<input checked="" type="checkbox"/> 4400	<input type="checkbox"/> VINYL SHUTTERS			NOTES:
	<input type="checkbox"/> HARDI	<input type="checkbox"/> 126CVG	<input type="checkbox"/> PLS	<input type="checkbox"/> CEDAR SHAKE	<input type="checkbox"/> 1261PC		
FASCIA/RAKE TRIM	<input type="checkbox"/> #2 PINE	<input checked="" type="checkbox"/> PRIMED PINE	<input type="checkbox"/> CEDAR	<input type="checkbox"/> AZEK	<input type="checkbox"/> #4 PINE & COIL		
SOFFIT/PORCH CEILING	<input type="checkbox"/> WOOD/PLY	<input checked="" type="checkbox"/> ALUMINUM	<input checked="" type="checkbox"/> VINYL	<input type="checkbox"/> EDGE & CNTR BEAD	<input type="checkbox"/> V-MATCH		
CORNERS	<input type="checkbox"/> AZEK	<input type="checkbox"/> 5/4 X 5	<input type="checkbox"/> 5/4 X 6	<input type="checkbox"/> 1X6	<input checked="" type="checkbox"/> VINYL	<input type="checkbox"/> SUPER	
HOUSEWRAP	<input checked="" type="checkbox"/> TYPAR	<input type="checkbox"/> DOW WRAP	<input type="checkbox"/> SLICKER				

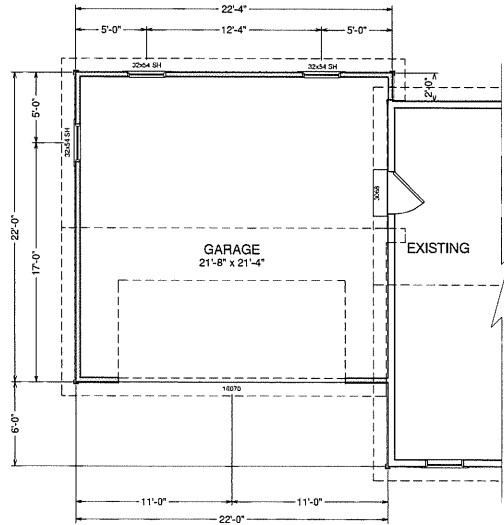

FLOOR PLAN

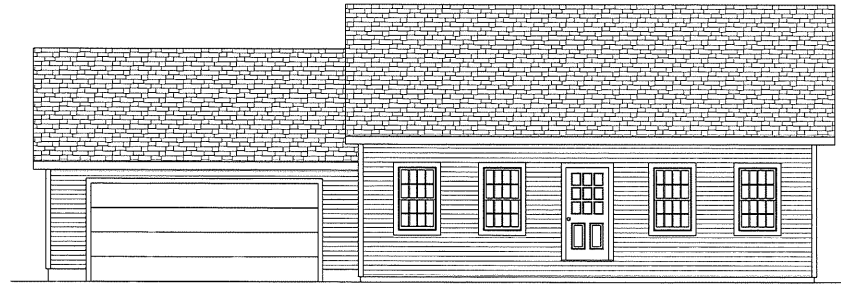

FRONT ELEVATION

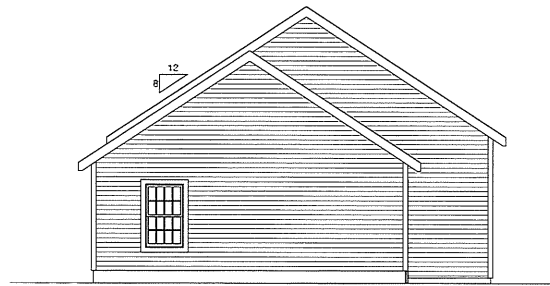

LEFT ELEVATION

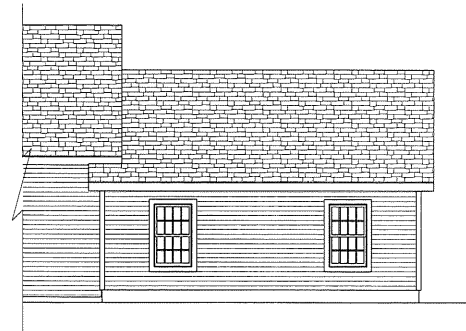

REAR ELEVATION

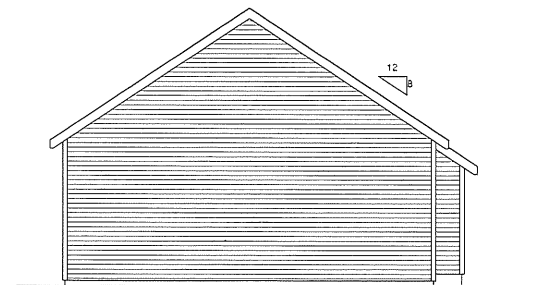

RIGHT ELEVATION

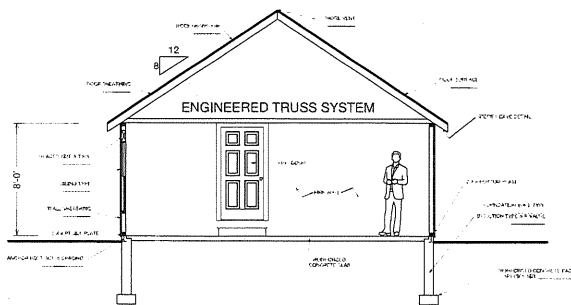

TYPICAL - NOT TO SCALE

"HOMEOWNER CONTRACTOR TO SPECIFY VALUES FOR EACH OF THE CALLOUTS. SOME CALLOUTS MAY NOT BE APPLICABLE"

"WHENEVER THERE ARE CONFLICTS BETWEEN THE CALLOUTS AND THE GENERAL NOTES, THE CALLOUTS SHALL PREVAIL. THE CONTRACTOR SHALL VERIFY THE CALLOUTS AND THE GENERAL NOTES WITH THE ARCHITECT BEFORE PROCEEDING WITH CONSTRUCTION."

**DISCLAIMER**  
 DRAWINGS ARE PREPARED BY HAMMOND HOME PLANNING CENTER INC. FOR THE ARCHITECT'S USE. THE ARCHITECT IS RESPONSIBLE FOR THE ACCURACY OF THE INFORMATION PROVIDED TO THE ARCHITECT AND FOR THE ACCURACY OF THE INFORMATION PROVIDED TO THE ARCHITECT. HAMMOND HOME PLANNING CENTER INC. IS NOT RESPONSIBLE FOR THE ACCURACY OF THE INFORMATION PROVIDED TO THE ARCHITECT.

**HAMMOND HOME PLANNING CENTER**  
 Drafting & Estimating  
 1000 Commercial Street  
 Portland, ME 04101  
 (207) 774-1111  
 www.hammondhpc.com

**REVISIONS**

PROJECT NO.	AD12151
DATE	12/4/2012
PROJECT	22' x 22' GARAGE ADDITION
SCALE	1/4" = 1'-0"
REV.	DESCRIPTION
PREL. 11/05/12	PRELIMINARY
RI. 11/06/12	REVISIONS
RE. 11/07/12	REVISIONS
FINL. 12/04/12	FINAL

**22' x 22' GARAGE ADDITION**

**ROB WING**

**HAMMOND HOME PLANNING CENTER**  
 12 LOCATIONS TO SERVE YOU BETTER  
 www.hammondhpc.com

RECEIVED

DEC 04 2012

Dept. of Building Inspections  
 City of Portland Maine

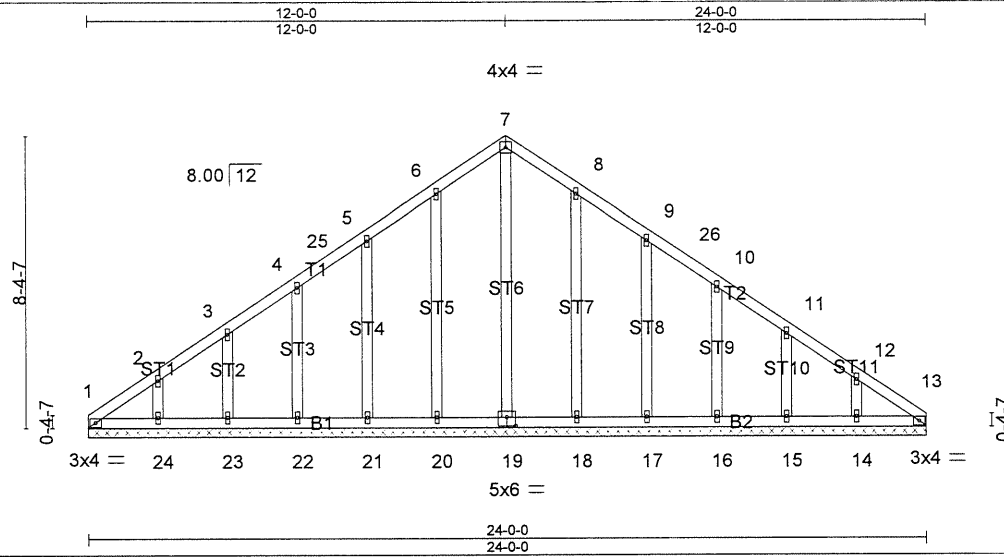

Plate Offsets (X,Y): [19:0-3-0,0-3-0]

<b>LOADING</b> (psf)	<b>SPACING</b>	<b>CSI</b>	<b>DEFL</b>	<b>PLATES</b>	<b>GRIP</b>
TCLL 61.6 (Ground Snow=80.0)	2-0-0 Plates Increase 1.15 Lumber Increase 1.15 Rep Stress Incr YES Code IBC2009/TPI2007	TC 0.14 BC 0.07 WB 0.42 (Matrix)	in (loc) l/defl L/d Vert(LL) n/a - n/a 999 Vert(TL) n/a - n/a 999 Horz(TL) 0.01 13 n/a n/a	MT20	169/123
TCDL 10.0				Weight: 106 lb FT = 0%	
BCLL 0.0 *					
BCDL 10.0					

<b>LUMBER</b>	<b>BRACING</b>
TOP CHORD 2x4 SPF 1650F 1.5E	TOP CHORD Structural wood sheathing directly applied or 6-0-0 oc purlins.
BOT CHORD 2x4 SPF 1650F 1.5E	BOT CHORD Rigid ceiling directly applied or 10-0-0 oc bracing.
OTHERS 2x4 SPF-S No.2	

MiTek recommends that Stabilizers and required cross bracing be installed during truss erection, in accordance with Stabilizer Installation guide.

**REACTIONS** (lb/size) 1=164/24-0-0 (min. 0-6-2), 13=164/24-0-0 (min. 0-6-2), 19=263/24-0-0 (min. 0-6-2), 20=323/24-0-0 (min. 0-6-2), 21=327/24-0-0 (min. 0-6-2), 22=329/24-0-0 (min. 0-6-2), 23=315/24-0-0 (min. 0-6-2), 24=368/24-0-0 (min. 0-6-2), 18=323/24-0-0 (min. 0-6-2), 17=327/24-0-0 (min. 0-6-2), 16=329/24-0-0 (min. 0-6-2), 15=315/24-0-0 (min. 0-6-2), 14=368/24-0-0 (min. 0-6-2)

Max Horz 1=-482(LC 6)  
 Max Uplift 1=-133(LC 6), 13=-37(LC 7), 20=-110(LC 7), 21=-122(LC 9), 22=-146(LC 8), 23=-180(LC 8), 24=-212(LC 8), 18=-97(LC 6), 17=-121(LC 8), 16=-146(LC 9), 15=-180(LC 9), 14=-211(LC 9)  
 Max Grav 1=225(LC 7), 13=164(LC 1), 19=263(LC 1), 20=463(LC 2), 21=437(LC 2), 22=341(LC 2), 23=315(LC 1), 24=369(LC 2), 18=463(LC 3), 17=437(LC 3), 16=341(LC 3), 15=315(LC 1), 14=369(LC 3)

**FORCES** (lb) - Maximum Compression/Maximum Tension

TOP CHORD 1-2=-436/284, 2-3=-342/268, 3-4=-258/258, 4-25=-173/240, 5-25=-166/246, 5-6=-167/264, 6-7=-175/366, 7-8=-175/366, 8-9=-167/264, 9-26=-61/145, 10-26=-140/133, 10-11=-140/91, 11-12=-176/102, 12-13=-268/116

BOT CHORD 1-24=-93/250, 23-24=-93/250, 22-23=-93/250, 21-22=-93/250, 20-21=-93/250, 19-20=-93/250, 18-19=-93/250, 17-18=-93/250, 16-17=-93/250, 15-16=-93/250, 14-15=-93/250, 13-14=-93/250

WEBS 7-19=-241/0, 6-20=-423/160, 5-21=-397/205, 4-22=-299/191, 3-23=-282/208, 2-24=-304/220, 8-18=-423/160, 9-17=-397/205, 10-16=-299/191, 11-15=-282/208, 12-14=-304/220

Continued on page 2

Job	Truss	Truss Type	Qty	Ply	
643488	1001	GER	1	1	A_MGE_E125954_10/31/2012 2:57:12 PM Job Reference (optional)

**NOTES (12)**

- 1) Wind: ASCE 7-05; 120mph (3-second gust); TCDL=6.0psf; BCDL=6.0psf; h=35ft; Cat. II; Exp C; enclosed; MWFRS (low-rise) gable end zone and C-C Corner(3) 0-0-0 to 3-0-0, Exterior(2) 3-0-0 to 9-0-0, Corner(3) 9-0-0 to 12-0-0, Exterior(2) 15-0-0 to 21-0-0 zone; cantilever left and right exposed ;C-C for members and forces & MWFRS for reactions shown; Lumber DOL=1.15 plate grip DOL=1.15
- 2) Truss designed for wind loads in the plane of the truss only. For studs exposed to wind (normal to the face), see Standard Industry Gable End Details as applicable, or consult qualified building designer as per ANSI/TPI 1.
- 3) TCLL: ASCE 7-05; Pg= 80.0 psf (ground snow); Pf=61.6 psf (flat roof snow); Category II; Exp C; Partially Exp.; Ct=1.1
- 4) Unbalanced snow loads have been considered for this design.
- 5) All plates are 1.5x4 MT20 unless otherwise indicated.
- 6) Gable requires continuous bottom chord bearing.
- 7) Gable studs spaced at 2-0-0 oc.
- 8) This truss has been designed for a 10.0 psf bottom chord live load nonconcurrent with any other live loads.
- 9) \* This truss has been designed for a live load of 20.0psf on the bottom chord in all areas where a rectangle 3-6-0 tall by 2-0-0 wide will fit between the bottom chord and any other members.
- 10) Provide mechanical connection (by others) of truss to bearing plate capable of withstanding 133 lb uplift at joint 1, 37 lb uplift at joint 13, 110 lb uplift at joint 20, 122 lb uplift at joint 21, 146 lb uplift at joint 22, 180 lb uplift at joint 23, 212 lb uplift at joint 24, 97 lb uplift at joint 18, 121 lb uplift at joint 17, 146 lb uplift at joint 16, 180 lb uplift at joint 15 and 211 lb uplift at joint 14.
- 11) This truss is designed in accordance with the 2009 International Building Code section 2306.1 and referenced standard ANSI/TPI 1.
- 12) Drawing prepared exclusively for manufacturing by Boise Structural Solutions

**LOAD CASE(S)** Standard

Job	Truss	Truss Type	Qty	Ply	
643488	1001	GER	1	1	A_MGE_E125954_10/31/2012 2:57:12 PM Job Reference (optional)

4' frost walls  
6" slab  
10" footing To Be  
Tie in To Existing Foundation

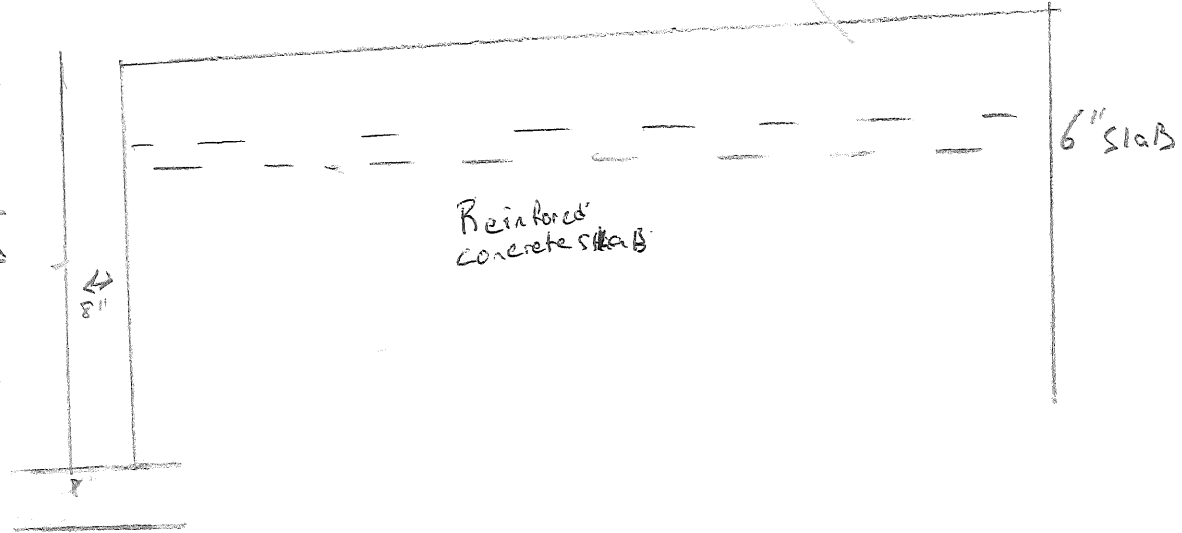

- 1/8 Bolts min
- 4-0' O.C.

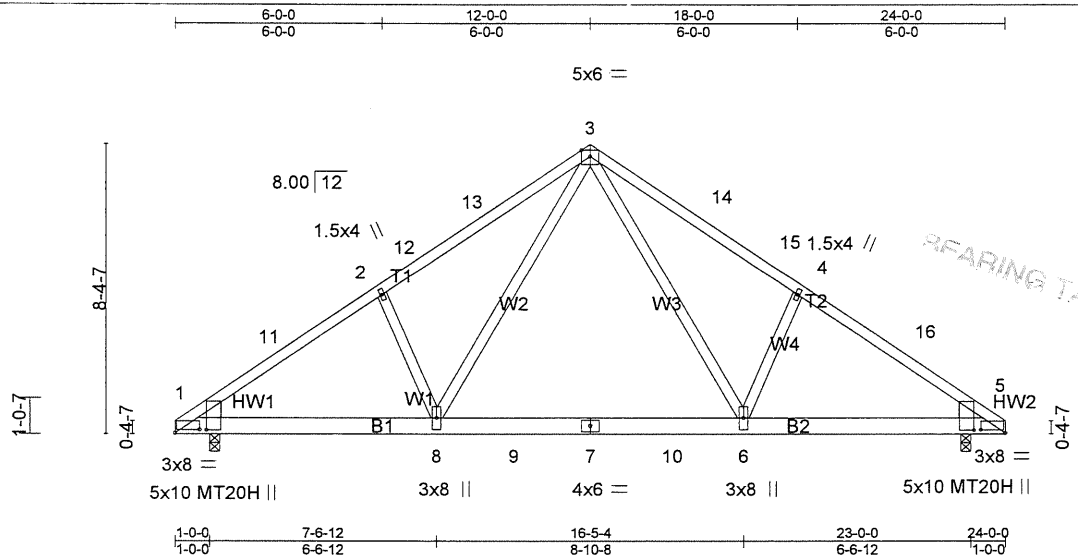

BRACING TAGS REQUIRED

Plate Offsets (X,Y): [1:0-8-8,0-1-2], [1:0-1-0,0-10-14], [5:0-8-8,0-1-2], [5:0-1-0,0-10-14]

<b>LOADING</b> (psf)	<b>SPACING</b>	<b>CSI</b>	<b>DEFL</b>	<b>PLATES</b>	<b>GRIP</b>
TCLL 61.6 (Ground Snow=80.0)	2-0-0 Plates Increase 1.15 Lumber Increase 1.15 Rep Stress Incr YES Code IBC2009/TPI2007	TC 0.89 BC 0.74 WB 0.75 (Matrix)	in (loc) l/defl L/d Vert(LL) -0.18 6-8 >999 240 Vert(TL) -0.27 6-8 >999 180 Horz(TL) 0.05 5 n/a n/a	MT20 MT20H	169/123 148/108
TCDL 10.0				Weight: 104 lb FT = 0%	
BCLL 0.0 *					
BCDL 10.0					

<b>LUMBER</b>	<b>BRACING</b>
TOP CHORD 2x4 SPF 2100F 1.8E BOT CHORD 2x6 SPF 1650F 1.5E WEBS 2x4 SPF-S No.2 WEDGE Left: 2x6 SPF 1650F 1.5E, Right: 2x6 SPF 1650F 1.5E	TOP CHORD Structural wood sheathing directly applied or 2-2-0 oc purlins. BOT CHORD Rigid ceiling directly applied or 10-0-0 oc bracing.
	MiTek recommends that Stabilizers and required cross bracing be installed during truss erection, in accordance with Stabilizer Installation guide.

**REACTIONS** (lb/size) 1=2023/0-3-8 (min. 0-3-3), 5=2023/0-3-8 (min. 0-3-3)  
Max Horz 1=-477(LC 6)  
Max Uplift 1=-486(LC 8), 5=-486(LC 9)

**FORCES** (lb) - Maximum Compression/Maximum Tension  
TOP CHORD 1-11=-3132/762, 2-11=-2891/784, 2-12=-2823/881, 12-13=-2580/897, 3-13=-2558/917, 3-14=-2558/917, 14-15=-2580/897, 4-15=-2823/881, 4-16=-2891/784, 5-16=-3132/762  
BOT CHORD 1-8=-508/2429, 8-9=-148/1555, 7-9=-148/1555, 7-10=-148/1555, 6-10=-148/1555, 5-6=-508/2429  
WEBS 2-8=-937/478, 3-8=-405/1327, 3-6=-405/1327, 4-6=-937/478

- NOTES** (12)
- 1) Wind: ASCE 7-05; 120mph (3-second gust); TCDL=6.0psf; BCDL=6.0psf; h=35ft; Cat. II; Exp C; enclosed; MWFRS (low-rise) gable end zone and C-C Exterior(2) 0-1-12 to 3-1-12, Interior(1) 3-1-12 to 9-0-0, Exterior(2) 9-0-0 to 12-0-0, Interior(1) 15-0-0 to 20-10-4 zone; cantilever left and right exposed ;C-C for members and forces & MWFRS for reactions shown; Lumber DOL=1.15 plate grip DOL=1.15
  - 2) TCLL: ASCE 7-05; Pg= 80.0 psf (ground snow); Pf=61.6 psf (flat roof snow); Category II; Exp C; Partially Exp.; Ct=1.1
  - 3) Unbalanced snow loads have been considered for this design.
  - 4) All plates are MT20 plates unless otherwise indicated.
  - 5) The solid section of the plate is required to be placed over the splice line at joint(s) 7.

Job	Truss	Truss Type	Qty	Ply	
643488	1000	REG	11	1	A_PMT_E125954_10/31/2012 2:57:12 PM Job Reference (optional)



**NOTES** (12)

- 7) This truss has been designed for a 10.0 psf bottom chord live load nonconcurrent with any other live loads.
- 8) \* This truss has been designed for a live load of 20.0psf on the bottom chord in all areas where a rectangle 3-6-0 tall by 2-0-0 wide will fit between the bottom chord and any other members, with BCDL = 10.0psf.
- 9) Provide mechanical connection (by others) of truss to bearing plate capable of withstanding 486 lb uplift at joint 1 and 486 lb uplift at joint 5.
- 10) This truss is designed in accordance with the 2009 International Building Code section 2306.1 and referenced standard ANSI/TPI 1.
- 11) "Semi-rigid pitchbreaks including heels" Member end fixity model was used in the analysis and design of this truss.
- 12) Drawing prepared exclusively for manufacturing by Boise Structural Solutions

**LOAD CASE(S)** Standard

Job	Truss	Truss Type	Qty	Ply	
643488	1000	REG	11	1	A_PMT_E125954_10/31/2012 2:57:12 PM Job Reference (optional)

# ALTERNATIVE BRACING INFORMATION

Trusses in some roof systems (IE: hip & gable end trusses) are not conducive to installation of lateral bracing. As an alternative in these special cases installation of "T" bracing is recommended. "T" bracing is, however, an alternative and should only be used in these special cases and is not intended to be used in lieu of an achievable lateral bracing system.

"T" BRACING CHART		
Number of Truss Plies	Lateral Bracing Required	Replace With
1	1 Row	2 X 4 "T" Brace
1	2 Rows	2 X 6 "T" Brace
2	1 Row	2 X 6 "T" Brace
2	2 Rows	2 X 6 "T" Brace
3	1 Row	2 X 6 "T" Brace
3	2 Rows	2 X 8 "T" Brace
4	1 Row	2 X 8 "T" Brace
4	2 Rows	2 X 8 "T" Brace

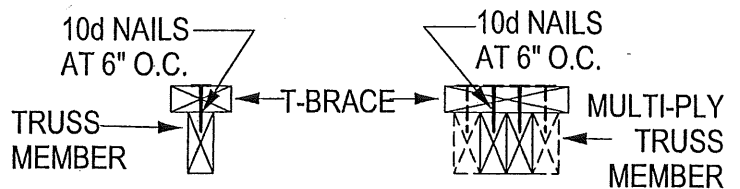
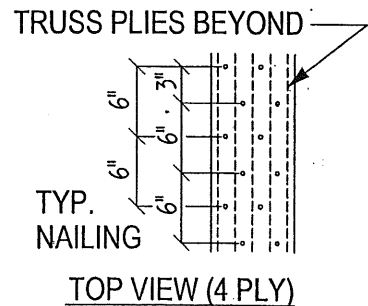
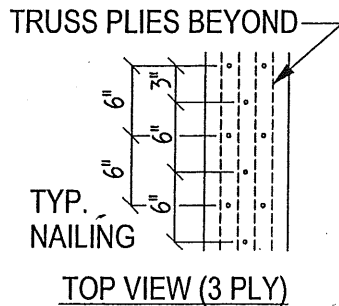
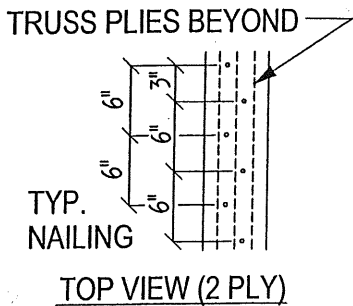

SEE TOP VIEWS ABOVE

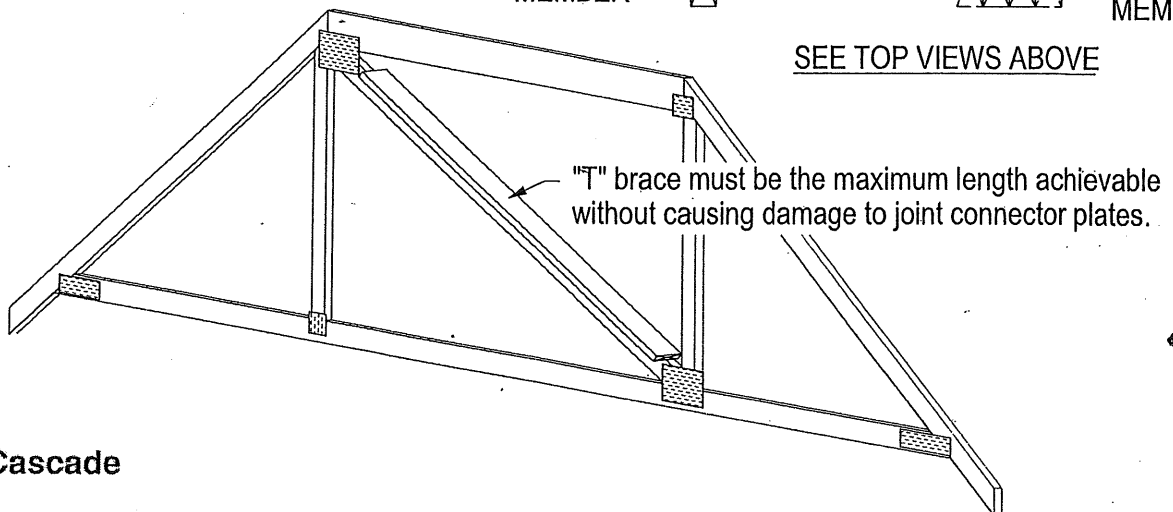

# Livingston-Hughes Surveyors

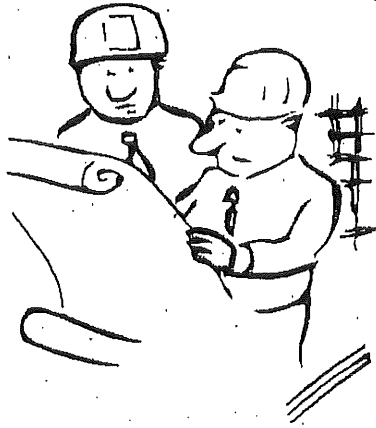

To: GORDON

From: DAVE

Date: 11/5

Please be aware of these important notes for  
the attached MLIP: Job # 760-63

NOTES:

THE GARAGE WIDTH OF 20' WILL WORK

22' DEPTH IS O.K. W/ THE REAR  
OF GARAGE BACK 2.1' FROM THE  
REAR OF HOUSE.

THE EXISTING REAR DECK AND BULKHEAD  
ARE INTO THE 25' REAR SETBACK.

*Please call with questions. Thanks!*

Side wall

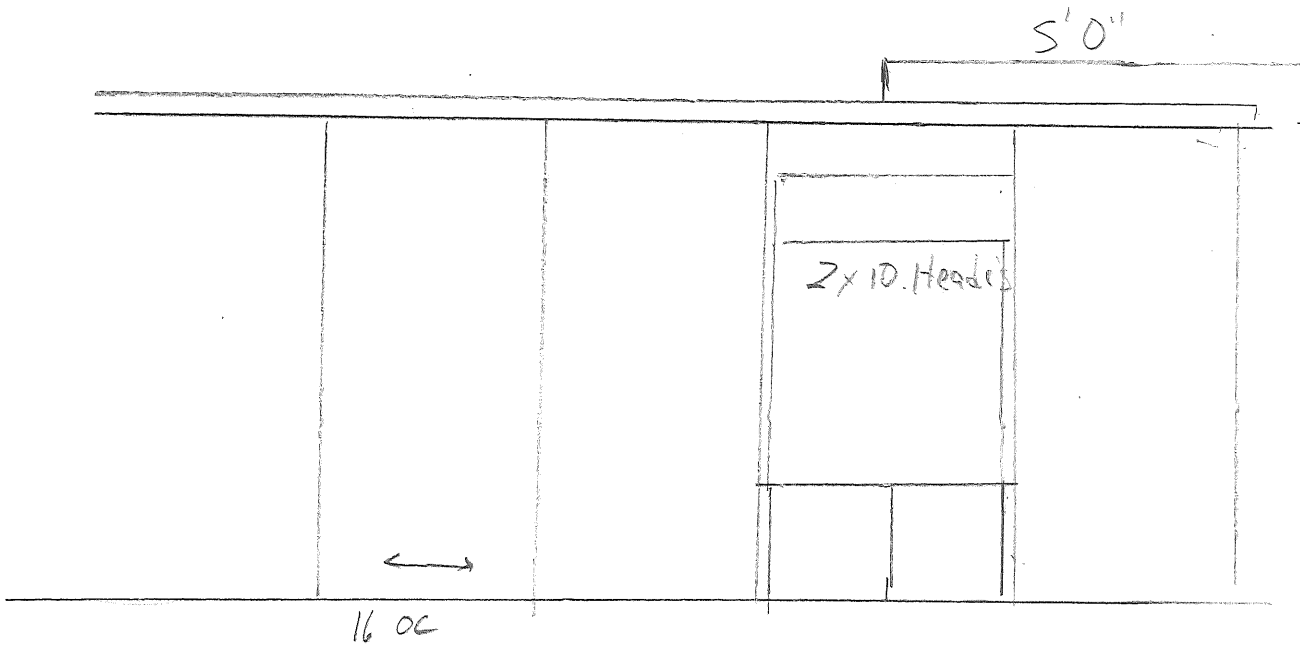

all Framing To Be 16 OC  
headers 2x10 with Jacks

Rear

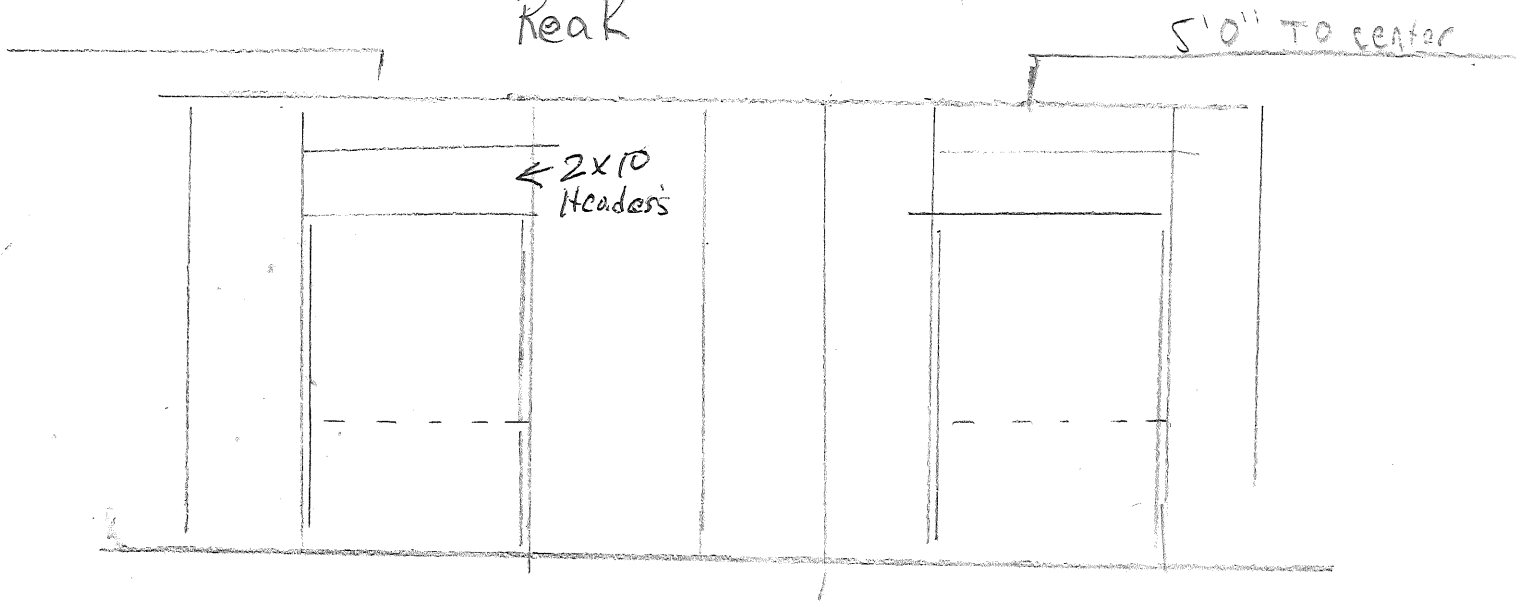

New to be Layed TO EXISTING WITH  
1/2" x 5" Lag Bolts

Direct Head access  
24 x 30 11' to exterior walls  
7' from Existing wall

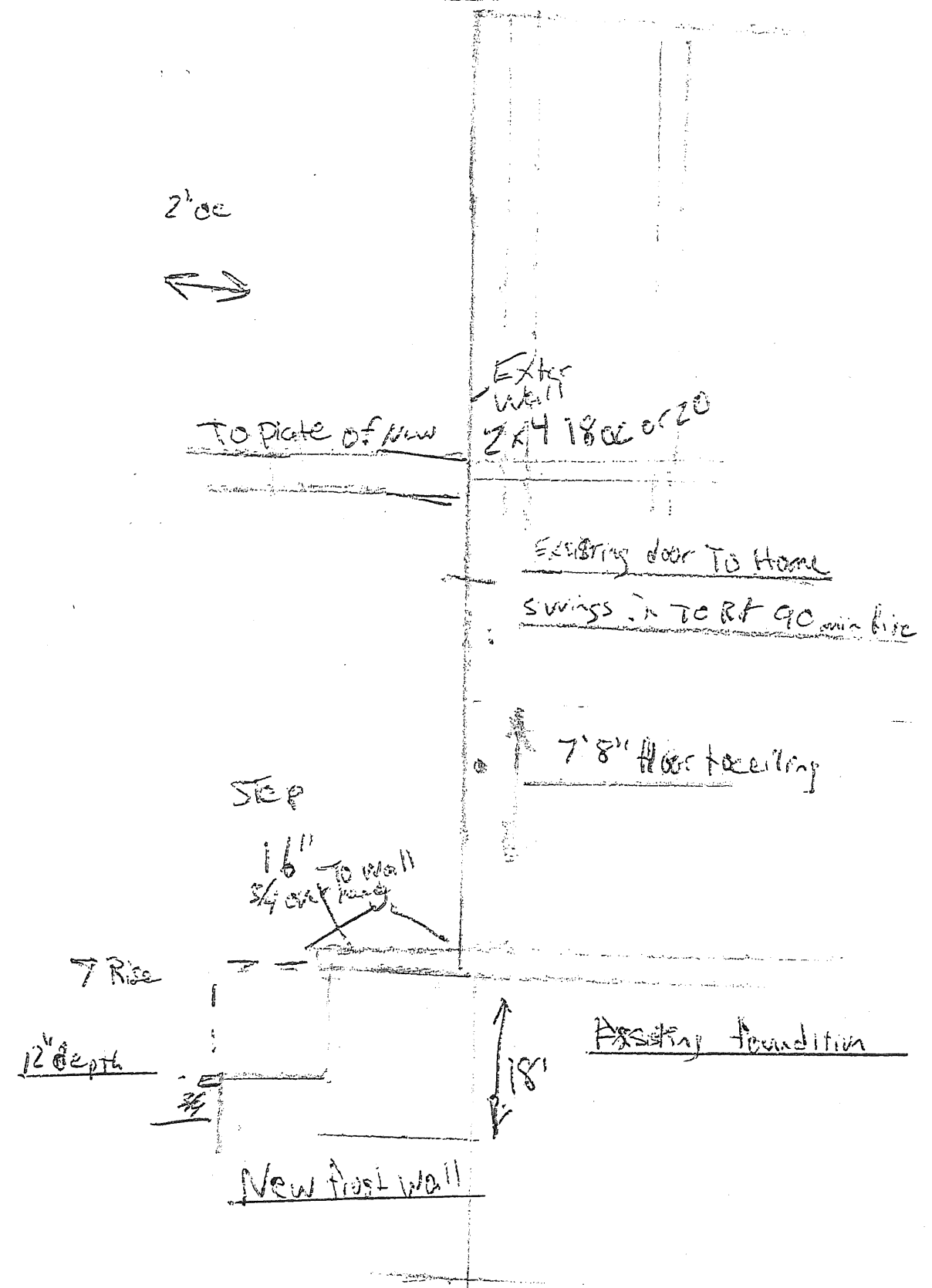
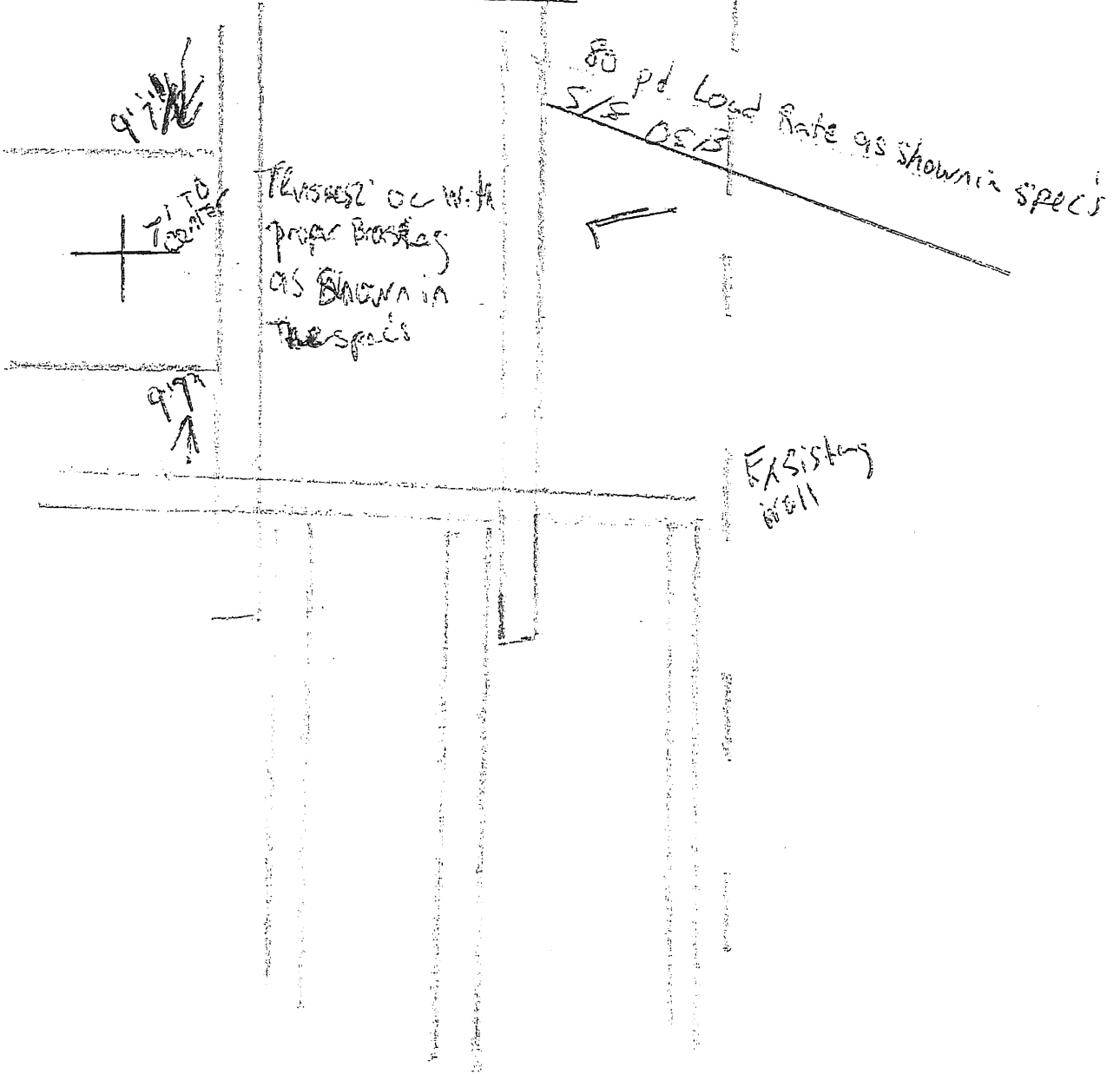

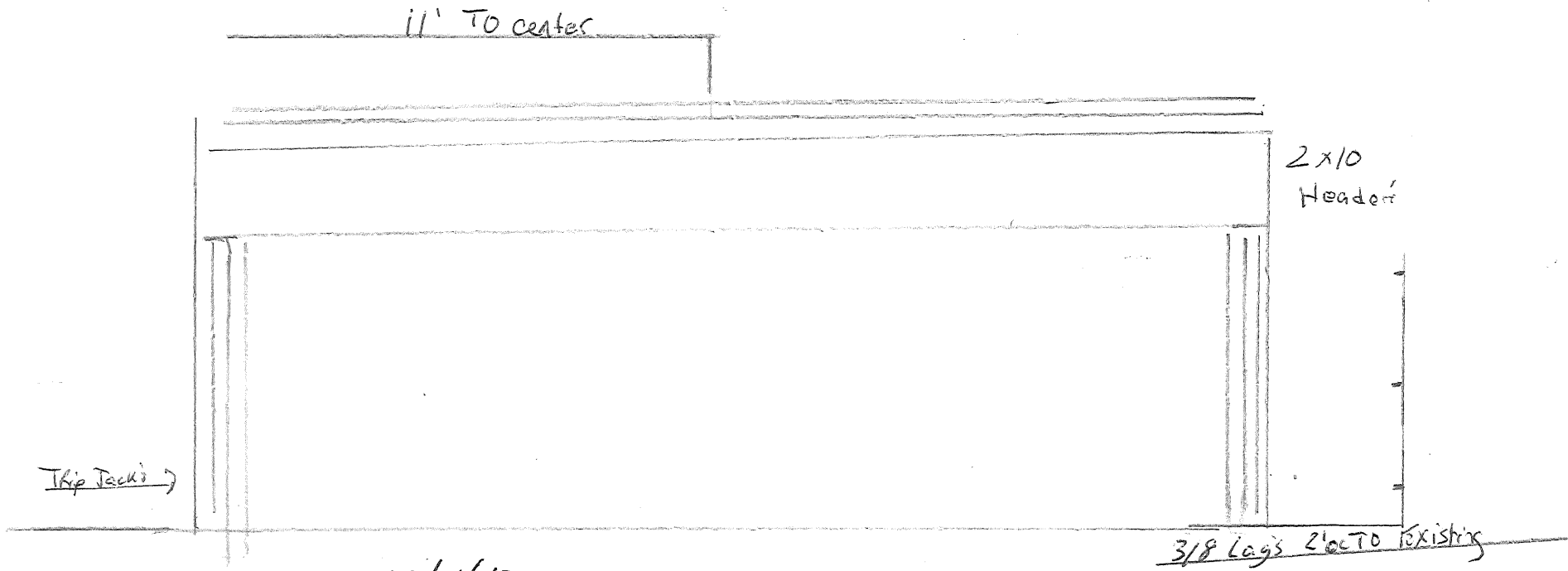

12/4/12  
 Applant to match

New Door TO BE installed For Entry

1/2 Sheet Rock on this side

7/16 OSB TO match existing

with 5/8 sheet Rock over

7/16 OSB For 1 hr fire

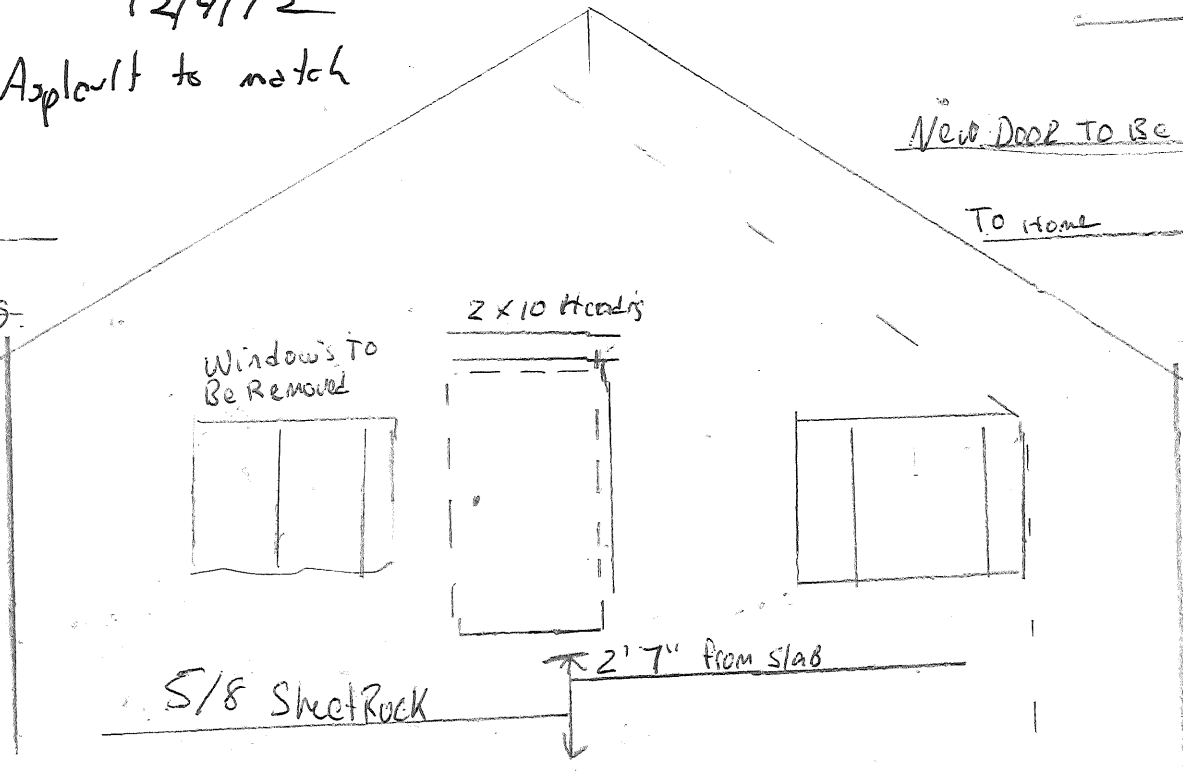

5/8 Sheet Rock

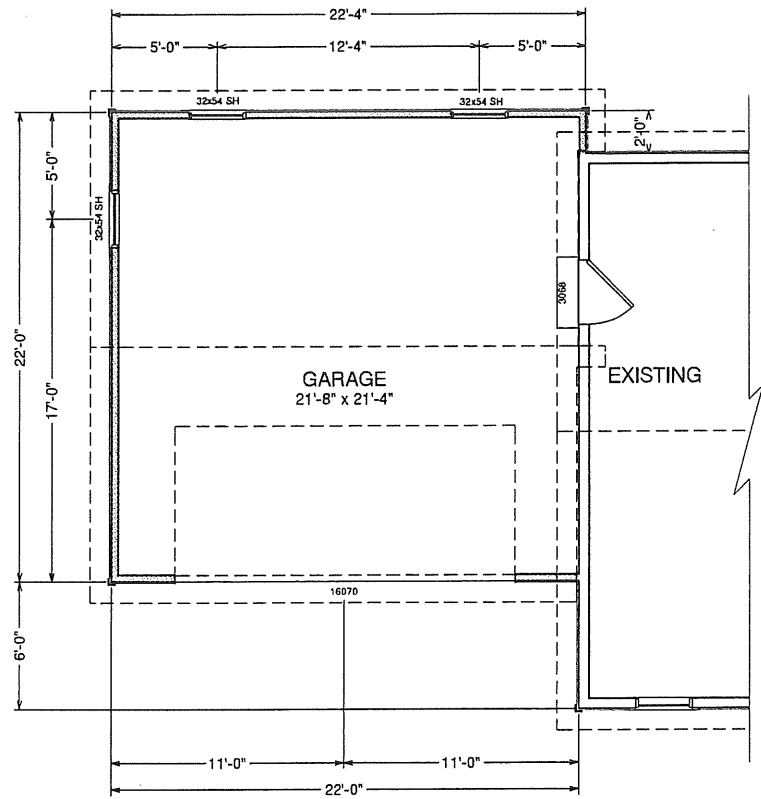

FLOOR PLAN

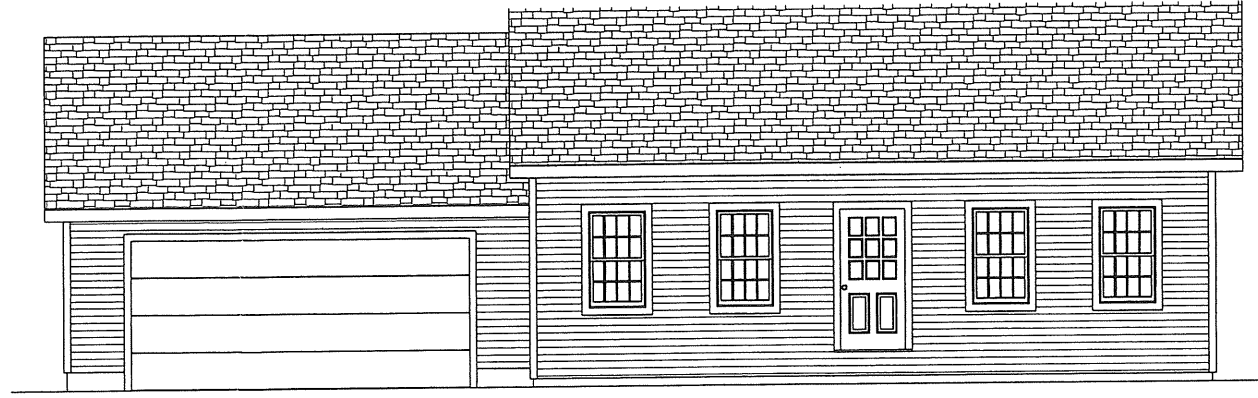

FRONT ELEVATION

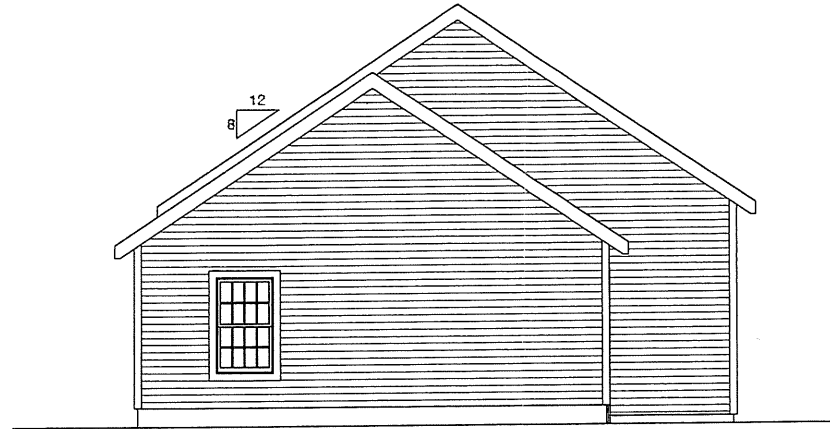

LEFT ELEVATION

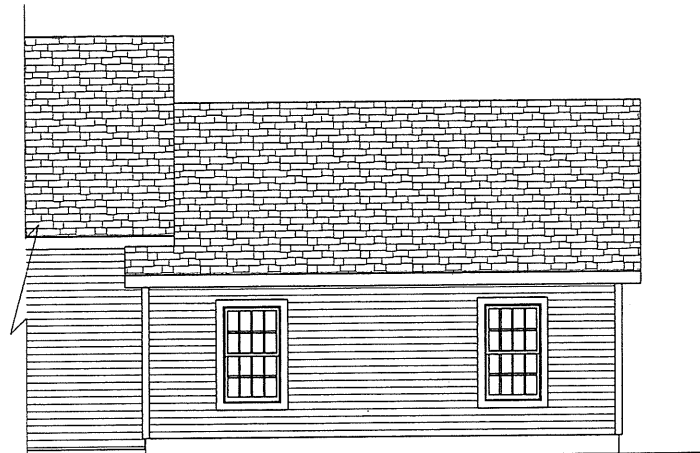

REAR ELEVATION

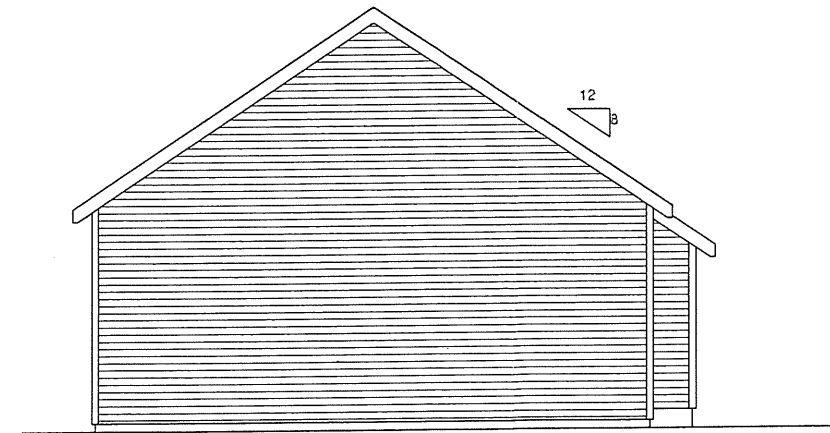

RIGHT ELEVATION

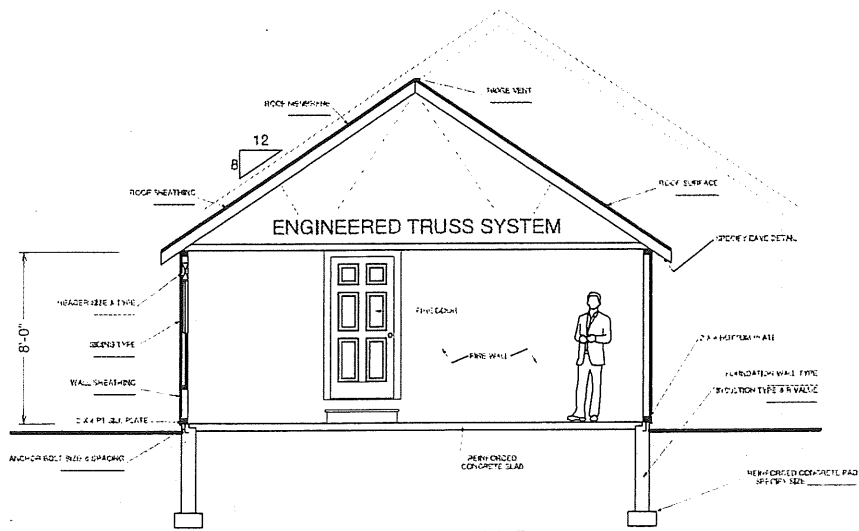

TYPICAL - NOT TO SCALE

\*HOMEOWNER/CONTRACTOR TO SPECIFY VALUES FOR EACH OF THE CALLOUTS. SOME CALLOUTS MAY NOT BE APPLICABLE\*

HAMMOND LUMBER COMPANY HAS PROVIDED THESE DRAWINGS FOR ILLUSTRATIVE AND INFORMATIONAL PURPOSES ONLY. THE HOMEOWNER/CONTRACTOR SHALL BE RESPONSIBLE FOR VERIFYING THAT THE MATERIALS PROVIDED WILL COMPLY WITH LOCAL, STATE, FEDERAL, AND ALL APPLICABLE CODES AND REGULATIONS. HAMMOND LUMBER COMPANY DOES NOT WARRANT THE ACCURACY OF THESE DRAWINGS. THE HOMEOWNER/CONTRACTOR SHALL BE RESPONSIBLE FOR VERIFYING THAT THE MATERIALS PROVIDED WILL COMPLY WITH LOCAL, STATE, FEDERAL, AND ALL APPLICABLE CODES AND REGULATIONS. THE DRAWINGS MUST BE USED AS A GUIDE ONLY AND NOT AS A SUBSTITUTE FOR PROFESSIONAL ENGINEERING. THE DRAWINGS MUST BE USED AS A GUIDE ONLY AND NOT AS A SUBSTITUTE FOR PROFESSIONAL ENGINEERING. THE DRAWINGS MUST BE USED AS A GUIDE ONLY AND NOT AS A SUBSTITUTE FOR PROFESSIONAL ENGINEERING.

**DISC**  
DRAWINGS ARE THE PROPERTY OF HAMMOND LUMBER COMPANY. NO PART OF THESE DRAWINGS MAY BE REPRODUCED OR TRANSMITTED IN ANY FORM OR BY ANY MEANS, ELECTRONIC OR MECHANICAL, INCLUDING PHOTOCOPYING, RECORDING, OR BY ANY INFORMATION STORAGE AND RETRIEVAL SYSTEM, WITHOUT THE WRITTEN PERMISSION OF HAMMOND LUMBER COMPANY.

**HOME PLANNING CENTER**  
Drafting & Estimating  
**Hammond Lumber Company**

**REVISIONS**

DATE	DESCRIPTION
12/4/2012	POR
1/4" = 10'	1 of 1

**PREPARED BY:** BEP  
**SCALE:** MRF

**REVISIONS:**

PRE:	11/05/12
R1:	11/06/12
R2:	11/07/12
FNL:	12/04/12

**22' x 22' GARAGE ADDITION**

**ROB WING**

**12 LOCATIONS TO SERVE YOU BETTER**  
www.hammondlum.com

**AUBURN** 282 POLAND RD. 04210 TOLL FREE 800-333-2836  
**BANGOR** 1097 HAMMOND ST. TOLL FREE 866-333-2264  
**BELGRADE** P.O. BOX 500 04017 TOLL FREE 800-333-2264  
**BOOTHBAY HARBOR** 218 TOWNSEND AVE TOLL FREE 1-866-HAMMOND  
**BRUNSWICK** 20 SPRING ST. TOLL FREE 800-333-2821  
**DAMARISCOTTA** 511 MAIN ST. TOLL FREE 1-866-HAMMOND  
**FAIRFIELD** 5 SUMMIT ST. 04937 TOLL FREE 866-333-2347  
**FARMINGTON** 388 FARMINGTON FALLS RD TOLL FREE 800-333-2328  
**GREENVILLE** 17 HANSEN ST. 04411 TOLL FREE 800-333-2786  
**PORTLAND** 300 RIVERSIDE ST. 04103 TOLL FREE 866-333-1950  
**SKOWHEGAN** 34 FENWELL ST. 04958 TOLL FREE 800-333-7346

RECEIVED  
DEC 04 2012

Dept. of Building Inspections  
City of Portland Maine