

**City of Portland, Maine - Building or Use Permit Application**  
 389 Congress Street, 04101 Tel: (207) 874-8703, Fax: (207) 874-8716

<b>PERMIT ISSUED</b>	
Permit No: 01-0758UN	Issue Date: 29 2001
CBL: 172 E002001	

<b>Location of Construction:</b> 14 Anthony Ave	<b>Owner Name:</b> Williams Brian K &	<b>Owner Address:</b> 14 Anthony Ave Portland, ME 04103	<b>Phone:</b> 207-797-5484
<b>Business Name:</b> n/a	<b>Contractor Name:</b> The Pool Shed	<b>Contractor Address:</b> Po Box 124: Rt. 35 W. Buxton	<b>Phone:</b> 2077975484
<b>Lessee/Buyer's Name:</b> n/a	<b>Phone:</b> n/a	<b>Permit Type:</b> Swimming Pools	<b>Zone:</b> R-3

<b>Past Use:</b> Single Family	<b>Proposed Use:</b> Same: Install a 18' X 36' Inground Swimming Pool. Call Catherine at 797-5484 when ready.	<b>Permit Fee:</b> \$96.00	<b>Cost of Work:</b> \$12,000.00	<b>CEO District:</b> 2
-----------------------------------	--	-------------------------------	-------------------------------------	---------------------------

<b>Proposed Project Description:</b> Install an 18' X 36' Inground Swimming Pool.	<b>FIRE DEPT:</b> <input type="checkbox"/> Approved <input type="checkbox"/> Denied <b>INSPECTION:</b> Use Group: <u>U</u> Type: <b>PERMIT ISSUED WITH REQUIREMENTS</b> Signature: <i>[Signature]</i> Signature: <i>[Signature]</i> PEDESTRIAN ACTIVITIES DISTRICT (P.A.D.) Action: <input type="checkbox"/> Approved <input type="checkbox"/> Approved w/Conditions <input type="checkbox"/> Denied Signature: _____ Date: _____
--	--

<b>Permit Taken By:</b> cjh	<b>Date Applied For:</b> 06/26/2001	<b>Zoning Approval</b>	
--------------------------------	--	------------------------	--

1. This permit application does not preclude the Applicant(s) from meeting applicable State and Federal Rules. 2. Building permits do not include plumbing, septic or electrical work. 3. Building permits are void if work is not started within six (6) months of the date of issuance. False information may invalidate a building permit and stop all work..	<b>Special Zone or Reviews</b> <input type="checkbox"/> Shoreland <input type="checkbox"/> Wetland <input type="checkbox"/> Flood Zone <input type="checkbox"/> Subdivision <input type="checkbox"/> Site Plan Maj <input type="checkbox"/> Minor <input type="checkbox"/> MM <input type="checkbox"/> Date: <i>06/29/01</i>	<b>Zoning Appeal</b> <input type="checkbox"/> Variance <input type="checkbox"/> Miscellaneous <input type="checkbox"/> Conditional Use <input type="checkbox"/> Interpretation <input type="checkbox"/> Approved <input type="checkbox"/> Denied Date: _____	<b>Historic Preservation</b> <input checked="" type="checkbox"/> Not in District or Landmark <input type="checkbox"/> Does Not Require Review <input type="checkbox"/> Requires Review <input type="checkbox"/> Approved <input type="checkbox"/> Approved w/Conditions <input type="checkbox"/> Denied Date: <i>9</i>
--	---	---	---

**PERMIT ISSUED WITH REQUIREMENTS**

**CERTIFICATION**

I hereby certify that I am the owner of record of the named property, or that the proposed work is authorized by the owner of record and that I have been authorized by the owner to make this application as his authorized agent and I agree to conform to all applicable laws of this jurisdiction. In addition, if a permit for work described in the application is issued, I certify that the code official's authorized representative shall have the authority to enter all areas covered by such permit at any reasonable hour to enforce the provision of the code(s) applicable to such permit.

SIGNATURE OF APPLICANT \_\_\_\_\_ ADDRESS \_\_\_\_\_ DATE \_\_\_\_\_ PHONE \_\_\_\_\_

RESPONSIBLE PERSON IN CHARGE OF WORK, TITLE \_\_\_\_\_ DATE \_\_\_\_\_ PHONE \_\_\_\_\_

# All Purpose Building Permit Application

If you or the property owner owes real estate or personal property taxes or user charges on any property within the City, payment arrangements must be made before permits of any kind are accepted.

Location/Address of Construction: 14 Anthony Avenue

Total Square Footage of Proposed Structure <u>18' x 36'</u>	Square Footage of Lot <u>See drawing</u>
--	---

<b>Tax Assessor's Chart, Block &amp; Lot</b>	Owner:	Telephone:
Chart# <u>172</u> Block# <u>E</u> Lot# <u>002</u>	<u>Brian &amp; Catherine Williams</u>	<u>797-5484</u>

Lessee/Buyer's Name (if Applicable)	Applicant name, address & telephone:	Cost Of Work: <u>\$12,000</u>  Fee: \$ <u>96.00</u>
-------------------------------------	--------------------------------------	---

Current use: Residential Home - Grass

If the location is currently vacant, what was prior use: \_\_\_\_\_

Approximately how long has it been vacant: \_\_\_\_\_

Proposed use: Swimming Pool 18' x 36' Inground

Project description:

Contractor's name, address & telephone:	<u>The Pool Shed P.O. Box 124, Route 35, West Buxton, ME 04093</u>
Who should we contact when the permit is ready:	<u>Catherine Williams - 797-5484</u>
Mailing address:	<u>MA <del>14</del> Anthony Avenue Portland, ME 04103</u>
	Phone: _____

**IF THE REQUIRED INFORMATION IS NOT INCLUDED IN THE SUBMISSIONS THE PERMIT WILL BE AUTOMATICALLY DENIED AT THE DISCRETION OF THE BUILDING/PLANNING DEPARTMENT, WE MAY REQUIRE ADDITIONAL INFORMATION IN ORDER TO APPROVE THIS PERMIT.**

*I hereby certify that I am the Owner of record of the named property, or that the owner of record authorizes the proposed work and that I have been authorized by the owner to make this application as his/her authorized agent. I agree to conform to all applicable laws of this jurisdiction. In addition, if a permit for work described in this application is issued, I certify that the Code Official's authorized representative shall have the authority to enter all areas covered by this permit at any reasonable hour to enforce the provisions of the codes applicable to this permit.*

Signature of applicant: <u>Catherine A Williams</u>	Date: <u>6/26/01</u>
---	----------------------

**This is not a permit, you may not commence ANY work until the permit is issued**

6

**BUILDING PERMIT REPORT**

DATE: 28 June 2001 ADDRESS: 14 Anthony Ave. CBL: 172-5-002  
REASON FOR PERMIT: 18'x36' inground swimming pool  
BUILDING OWNER: Brian K Williams  
PERMIT APPLICANT: \_\_\_\_\_ CONTRACTOR: The Pool Shed  
USE GROUP: U CONSTRUCTION TYPE: \_\_\_\_\_ CONSTRUCTION COST: 12,000.00 PERMIT FEES: 96.00

The City's Adopted Building Code (The BOCA National Building Code/1999 with City Amendments)  
The City's Adopted Mechanical Code (The BOCA National Mechanical Code/1993)

**CONDITION(S) OF APPROVAL**

This permit is being issued with the understanding that the following conditions shall be met: \*1/43

1. This permit does not excuse the applicant from meeting applicable State and Federal rules and laws.
2. Before ~~the City's Building Code walls~~ ~~concrete for foundation is placed~~, approval from the Development Review Coordinator and Inspection Services must be obtained. (A 24 hour notice is required prior to inspection) **"ALL LOT LINES SHALL BE CLEARLY MARKED BEFORE CALLING."**
3. Foundation drain shall be placed around the perimeter of a foundation that consists of gravel or crushed stone containing not more than 10 percent material that passes through a No. 4 sieve. The drain shall extend a minimum of 12 inches beyond the outside edge of the footing. The thickness shall be such that the bottom of the drain is not higher than the bottom of the base under the floor, and that the top of the drain is not less than 6 inches above the top of the footing. The top of the drain shall be covered with an approved filter membrane material. Where a drain tile or perforated pipe is used, the invert of the pipe or tile shall not be higher than the floor elevation. The top of joints or top of perforations shall be protected with an approved filter membrane material. The pipe or tile shall be placed on not less than 2" of gravel or crushed stone, and shall be covered with not less than 6" of the same material. Section 1813.5.2
4. Foundations anchors shall be a minimum of 1/2" in diameter, 7" into the foundation wall, minimum of 12" from corners of foundation and a maximum 6' O.C. between bolts. Section 2305.17
5. Waterproofing and dampproofing shall be done in accordance with Section 1813.0 of the building code.
6. Precaution must be taken to protect concrete and masonry. Concrete Sections 1908.9-19.8.10/ Masonry Sections 2111.3-2111.4.
7. It is strongly recommended that a registered land surveyor check all foundation forms before concrete is placed. This is done to verify that the proper setbacks are maintained.
8. Private garages located beneath habitable rooms in occupancies in Use Group R-1, R-2, R-3 or I-1 shall be separated from adjacent interior spaces by fire partitions and floor/ceiling assembly which are constructed with not less than 1-hour fire resisting rating. Private garages attached side-by-side to rooms in the above occupancies shall be completely separated from the interior spaces and the attic area by means of 1/2 inch gypsum board or the equivalent applied to the garage side. (Chapter 4, Section 407.0 of the BOCA/1999)
9. All chimneys and vents shall be installed and maintained as per Chapter 12 of the City's Mechanical Code. (The BOCA National Mechanical Code/1993). Chapter 12 & NFPA 211
10. Sound transmission control in residential building shall be done in accordance with Chapter 12, Section 1214.0 of the City's Building Code.
11. Guardrails & Handrails: A guardrail system is a system of building components located near the open sides of elevated walking surfaces for the purpose of minimizing the possibility of an accidental fall from the walking surface to the lower level. Minimum height all Use Groups 42". In occupancies in Use Group A, B,H-4, I-1, I-2, M, R, public garages and open parking structures, open guards shall have balusters or be of solid material such that a sphere with a diameter of 4" cannot pass through any opening. Guards shall not have an ornamental pattern that would provide a ladder effect. Handrails shall be a minimum of 34" but not more than 38". Exception: Handrails that form part of a guard shall have a height not less than 36 inches (914 mm) and not more than 42 inches (1067 mm). Handrail grip size shall have a circular cross section with an outside diameter of at least 1 1/4" and not greater than 2". (Sections 1021 & 1022.0). Handrails shall be on both sides of stairway. (Section 1014.7) **R-3 (ONE & TWO FAMILY DWELLINGS) GUARD HEIGHT IS 36" MINIMUM.**
12. Headroom in habitable space is a minimum of 7'6". (Section 1204.0)
13. Stair construction in Use Group R-3 & R-4 is a minimum of 10" tread and 7 1/2" maximum rise. All other Use Group minimum 11" tread, 7" maximum rise. (Section 1014.0)
14. The minimum headroom in all parts of a stairway shall not be less than 80 inches. (6'8") 1014.4
15. The Minimum required width of a corridor shall be determined by the most restrictive of the criteria under section 1011.3 but not less than 36".
16. Every sleeping room below the fourth story in buildings of Use Groups R and I-1 shall have at least one operable window or exterior door approved for emergency egress or rescue. The units must be operable from the inside without the use of special knowledge or separate tools. Where windows are provided as means of egress or rescue they shall have a sill height not more than 44 inches (1118mm) above the floor. All egress or rescue windows from sleeping rooms shall have a minimum net clear opening height dimension of 24 inches (610mm). The minimum net clear opening width dimension shall be 20 inches (508)mm, and a minimum net clear opening of 5.7 sq. ft. (Section 1010.4)
17. Each apartment shall have access to two (2) separate, remote and approved means of egress. A single exit is acceptable when it exits directly from the apartment to the building exterior with no communications to other apartment units. (Section 1010.1)
18. All vertical openings shall be enclosed with construction having a fire rating of at least one (1) hour, including fire doors with self closure's. (Over 3 stories in height requirements for fire rating is two (2) hours. (Section 710.0)
19. The boiler shall be protected by enclosing with (1) hour fire rated construction including fire doors and ceiling, or by providing automatic extinguishment. (Table 302.1.1)

6/26

20. All single and multiple station smoke detectors shall be of an approved type and shall be installed in accordance with the provisions of the City's Building Code Chapter 9, Section 920.3.2 (BOCA National Building Code/1999), and NFPA 101 Chapter 18 & 19. (Smoke detectors shall be installed and maintained at the following locations):
  - In the immediate vicinity of bedrooms
  - In all bedrooms
  - In each story within a dwelling unit, including basements
21. A portable fire extinguisher shall be located as per NFPA #10. They shall bear the label of an approved agency and be of an approved type. (Section 921.0)
22. The Fire Alarm System shall be installed and maintained to NFPA #72 Standard.
23. The Sprinkler System shall be installed and maintained to NFPA #13 Standard.
24. All exit signs, lights and means of egress lighting shall be done in accordance with Chapter 10 Section & Subsections 1023.0 & 1024.0 of the City's Building Code. (The BOCA National Building Code/1999)
25. Section 25 – 135 of the Municipal Code for the City of Portland states, "No person or utility shall be granted a permit to excavate or open any street or sidewalk from the time of November 15 of each year to April 15 of the following year".
26. The builder of a facility to which Section 4594-C of the Maine State Human Rights Act Title 5 MRSA refers, shall obtain a certification from a design professional that the plans commencing construction of the facility, the builder shall submit the certification the Division of Inspection Services.
27. Ventilation and access shall meet the requirements of Chapter 12 Sections 1210.0 and 1211.0 of the City's Building Code. (Crawl spaces & attics).
- \*28. All electrical, plumbing and HVAC permits must be obtained by Master Licensed holders of their trade. No closing in of walls until all electrical (min. 72 hours notice) and plumbing inspections have been done.
29. All requirements must be met before a final Certificate of Occupancy is issued.
30. All building elements shall meet the fastening schedule as per Table 2305.2 of the City's Building Code (The BOCA National Building Code/1996).
31. Ventilation of spaces within a building shall be done in accordance with the City's Mechanical code (The BOCA National Mechanical Code/1993). (Chapter M-16)
32. Please read and implement the attached Land Use Zoning report requirements.
33. Boring, cutting and notching shall be done in accordance with Sections 2305.3, 2305.3.1, 2305.4.4 and 2305.5.1 of the City's Building Code.
34. Bridging shall comply with Section 2305.16.
35. Glass and glazing shall meet the requirements of Chapter 24 of the building code. (Safety Glazing Section 2406.0)
36. All flashing shall comply with Section 1406.3.10.
37. All signage shall be done in accordance with Section 3102.0 signs of the City's Building Code, (The BOCA National Building Code/1999).
- \*38. Read and implement attached Section 421.0 Swimming pool rules and regulations.

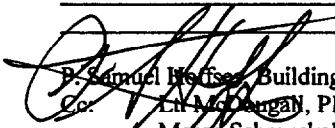
  
 P. Samuel Hennessey, Building Inspector  
 Co. Lt. M. Morgan, PFD  
 Marge Schmuckal, Zoning Administrator  
 Michael Nugent, Inspection Service Manager

PSH 10/1/00

**\*\*This permit is herewith issued, on the basis of plans submitted and conditions placed on these plans, any deviations shall require a separate approval.**

**\*\*\*THIS PERMIT HAS BEEN ISSUED WITH THE UNDERSTANDING THAT ALL THE CONDITIONS OF THE APPROVAL SHALL BE COMPLETED. THEREFORE, BEFORE THE WORK IS COMPLETED A REVISED PLAN OR STATEMENT FROM THE PERMIT HOLDER SHALL BE SUBMITTED TO THIS OFFICE SHOWING OR EXPLAINING THAT THE CONDITIONS HAVE BEEN MET. IF THIS REQUIREMENT IS NOT RECEIVED YOUR CERTIFICATE OF OCCUPANCY SHALL BE WITHHELD. ( You Shall Call for Inspections )**

**\*\*\*\*ALL PLANS THAT REQUIRE A PROFESSIONAL DESIGNER'S SEAL, (AS PER SECTION 114.0 OF THE BUILDING CODE) SHALL ALSO BE PRESENTED TO THIS DIVISION ON AUTO CAD LT. 2000, DXF FORMAT OR EQUIVALENT.**

**\*\*\*\*\*CERTIFICATE OF OCCUPANCY FEE \$50.00**



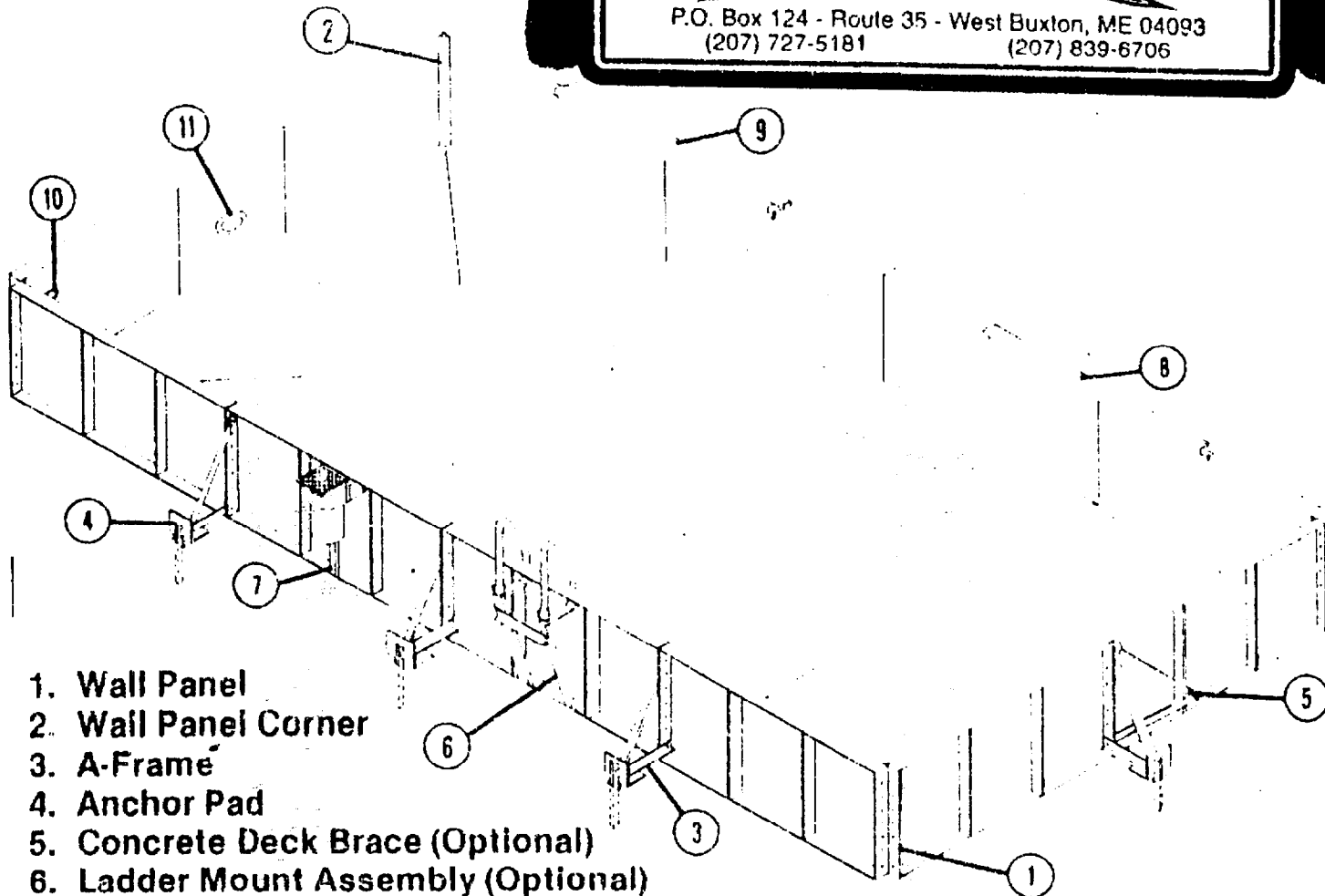

1. Wall Panel
2. Wall Panel Corner
3. A-Frame
4. Anchor Pad
5. Concrete Deck Brace (Optional)
6. Ladder Mount Assembly (Optional)
7. Skimmer Support
8. "Holiday" Rim Coping
9. 8" Snap-Strip Coping (Optional)
10. Return Fitting
11. Underwater Light (Optional)

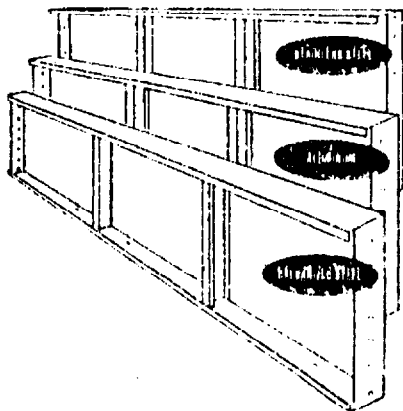

Stainless steel walls are manufactured from super-strong .060 stainless steel to withstand unusual stress conditions. This structurally superior material offers exceptional strength, optimum corrosion resistance and ease of installation.

ALCLAD aluminum 5" walls provide added protection against corrosive attack by water and soil. Features two 5" extruded aluminum upright braces on each panel.

Galvanized 14 gauge corrosion-resistant 5" steel walls feature two 5" upright braces specially welded for unmatched support.

FIGURE 1 -- POOL EXCAVATION LAYOUT

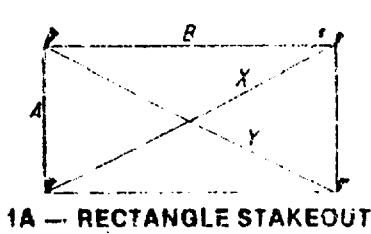

1A -- RECTANGLE STAKEOUT

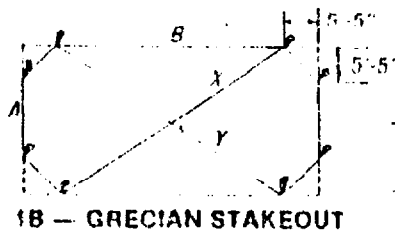

1B -- GRECIAN STAKEOUT

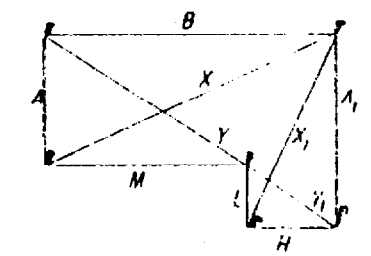

1C -- TRUE "L" STAKEOUT

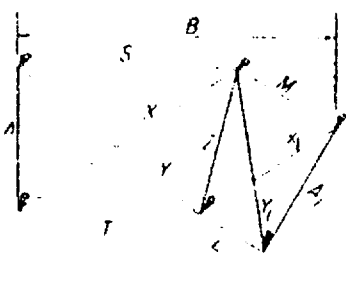

1D -- LAZY "L" STAKEOUT

EXCAVATION NOT POOL MEASUREMENTS

POOL SIZE	EXCAVATION SIZE		EXCAVATION DIAGONALS	
	A	B	X	Y
12' x 24'	16'	20'	32' - 3"	
14' x 28'	18'	32'	36' - 0 1/2"	
16' x 24'	20'	28'	34' - 4 1/2"	
16' x 32'	20'	36'	41' - 2 1/2"	
16' x 34'	20'	38'	42' - 11 1/2"	
16' x 40'	20'	44'	48' - 4"	
18' x 36'	22'	40'	45' - 7 1/2"	
20' x 40'	24'	44'	50' - 1 1/2"	
24' x 48'	28'	52'	59' - 6 3/4"	
30' x 60'	34'	64'	72' - 5 1/2"	
16 1/2' x 32 1/2'	20 1/2'	36 1/2'	32' - 10 1/2"	
16 1/2' x 35'	20 1/2'	39 1/2'	35' - 2 1/2"	
18 1/2' x 40 1/2'	22 1/2'	44 1/2'	40' - 5 1/2"	
20 1/2' x 44 1/2'	24 1/2'	40 1/2'	44' - 11 1/2"	

FIGURE 2 -- INITIAL FORMING OF POOL BOTTOM

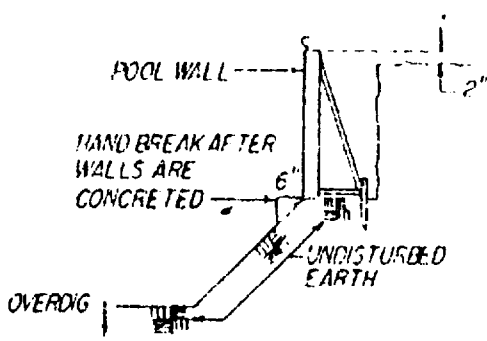

EXCAVATION SIZE	POOL SIZE			
	16'x36'x24' "L"	20'x44'x36' "L"	18'x40'x20' "L"	20'x46'x24' "L"
A	20'	24'	20'	24'
B	40'	48'	44' - 11 1/2"	50' - 10 1/2"
A <sub>1</sub>	28'	40'	20'	24'
H	16'	20'	---	---
L	8'	16'	10' - 2 1/2"	10' - 2 1/2"
M	24'	28'	15' - 6 1/2"	16' - 6 1/2"
S	---	---	31' - 6 1/2"	36' - 6 1/2"
T	---	---	26' - 2 1/2"	30' - 2 1/2"
EXCAVATION DIAGONALS				
X	44' - 8 1/2"	53' - 8"	37' - 4 1/2"	43' - 6 1/2"
Y	31' - 2 1/2"	36' - 10 1/2"	32' - 11 1/2"	38' - 6 1/2"
X <sub>1</sub>	32' - 3"	44' - 8 1/2"	22' - 5 1/2"	26' - 0 1/2"
Y <sub>1</sub>	17' - 10 1/2"	25' - 7 1/2"	35' - 3 1/2"	29' - 1 1/2"
Z	---	---	20' - 8 1/2"	24' - 10"

FIGURE 3 -- POOL EXCAVATION

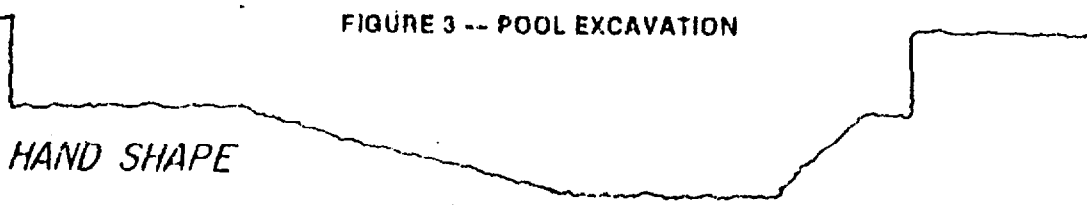

3A -- ROUGH EXCAVATION

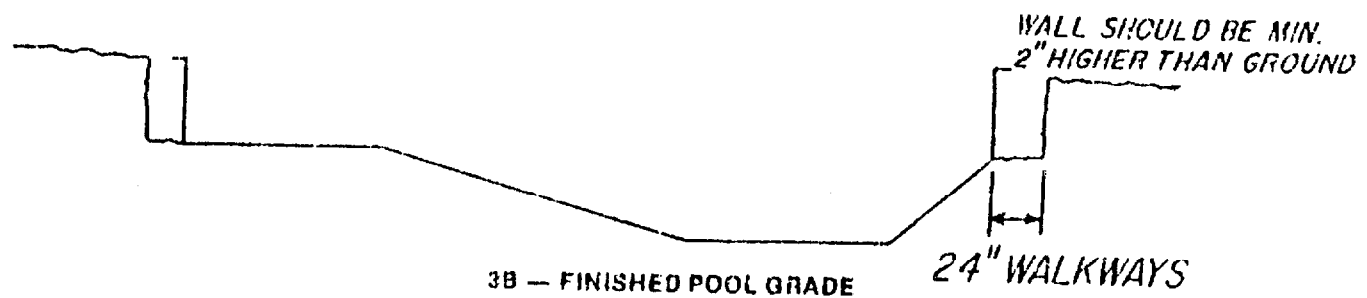

3B -- FINISHED POOL GRADE