

City of Portland Fire Alarm Permits

1. 52 Center St Permit# 090850
2. India St Engine House Permit# (last year) 091448
3. 535 Ocean Ave Permit# 091293
4. Forest Ave plaza Permit# 091416
5. Americold Permit# 100150
6. Waste Management Permit# 10033
7. Pat's Pizza Permit# 100112
8. Serenity House Permit# 091241 (phone line issue) last year.



Fire Alarm Permit

If you or the property owner owes real estate or property taxes or user charges on any property within the city, payment arrangements must be made before permits of any kind are accepted.

Installation address: 165 Read Street CBL: _____

Exact location: (within structure) Enter center door of building

Type of occupancy(s) (NFPA & ICC): Warehousing

Building owner: Americold

System Designer (point of contact): ^{Must be} Robin Russell

Designer phone: (207) 347-5327 E-mail: rrussell@protectionone.com

Installing contractor: Protection One Certificate of Fitness No: 1003

Contractor phone: (207) 347-5316 E-mail: johnkempton@protectionone.com

This is a new application: YES NO

This is an amendment to an existing permit: YES NO Permit no: _____

The following documents shall be provided with this application:

- Floor plans
- Wiring diagram
- Annunciator details
- Equipment data sheets
- Battery & voltage drop calculations
- Input/ Output Matrix
- Designer qualifications
- Electrical Permit Pulled (check alarm/com)

<p>COST OF WORK: <u>3850</u></p> <p>PERMIT FEE: <u>50</u> <small>(\$10 PER \$1,000 + \$30 FOR THE FIRST \$1,000)</small></p>

The designer shall be the responsible party for this application. Download a new copy of this application at www.portlandmaine.gov/fire for every submittal. Submit all plans in electronic PDF in addition to full sized plans to the Building Inspections Department, 389 Congress Street, Room 315, Portland, Maine 04101.

Prior to acceptance of any fire alarm system, a complete commissioning and acceptance test must be coordinated with all fire system contractors and the Fire Department, and proper documentation of such test(s) provided.

All installation(s) must comply with the *City of Portland Technical Standard for Signaling Systems for the Protection of Life and Property*, available at www.portlandmaine.gov/fire.

Applicant signature: Robin Russell Date: 2/18/10

DISPLAY THIS CARD ON PRINCIPAL FRONTAGE OF WORK

CITY OF PORTLAND

BUILDING INSPECTION

PERMIT

Permit Number: 100150

Please Read Application And Notes, if Any, Attached

This is to certify that Mrs Real Estate Lp/Protection One has permission to Install Fire Alarm System AT 165 Read St CBI 148 A003001

provided that the person or persons, firm or corporation accepting this permit shall comply with all of the provisions of the Statutes of Maine and of the Ordinances of the City of Portland regulating the construction, maintenance and use of buildings and structures, and of the application on file in this department.

Apply to Public Works for street line and grade if nature of work requires such information.

PERMIT IS 24 HOUR NOTICES REQUIRED.

Notification of inspection must be given and written permission procured before this building or part thereof is attached for otherwise closed-in. 24

A certificate of occupancy must be procured by owner before this building or part thereof is occupied.

OTHER REQUIRED APPROVALS

Fire Dept 2/2/10
Health Dept 2/2/10
Appeal Board CITY OF PORTLAND
Other Department

James Bowke
Director - Building & Inspection Services

PENALTY FOR REMOVING THIS CARD

INPUT/OUTPUT MATRIX

	Heat Detector	Manual Pulbox	Trouble	Battery fault	Power fault	Ground fault
Activate Fire Alarm Horn (TEMPORAL)/ Strobes	X	X				
Sound local piezo	X	X	X	X	X	X
Indicate at annunciator	X	X	X	X	X	X
Send alarm signal to remote monitoring	X	X				
Send trouble signal to remote monitoring			X	X	X	X
Send supervisory signal to remote monitoring						
Illuminate LED on the device						

MS-10UD-7 Battery Calculations

Note 1: You can edit all current draws and are fully responsible for verifying these calculations.
Note 2: You only need to make entries in the yellow cells.

Device Type	Primary Non-Alarm (Amps)			Primary Alarm (Amps)			Secondary Non-Alarm (Amps)					
	Qty	Current Draw	Total	Qty	Current Draw	Total	Qty	Current Draw	Total			
1. System												
Main Circuit Board	1	x	0.08500	0.08500	1	x	0.17500	0.17500	1	x	0.08500	0.08500
4XTMF	1	x	0.00500	0.00500	1	x	0.01100	0.01100	1	x	0.00500	0.00500
CAC-5X	0	x	0.00100		0	x	0.00100		0	x	0.00100	
IPDACT	0	x	0.10000		0	x	0.30000		0	x	0.10000	
2. Annunciators												
ANN-80	0	x	0.03700		0	x	0.04000		0	x	0.01500	
ANN-RLY	1	x	0.01500	0.01500	1	x	0.07500	0.07500	1	x	0.01500	0.01500
ANN-I/O	0	x	0.03500		0	x	0.20000		0	x	0.03500	
ANN-I/O LEDs	0	x	0.00000		0	x	0.01000		0	x	0.00000	
ANN-S/PG	0	x	0.04500		0	x	0.04500		0	x	0.04500	
ANN-LED	0	x	0.02800		0	x	0.06800		0	x	0.02800	
3. Resettable Power												
2-wire Detector Heads	0	x	0.00000		0	x	0.00000		0	x	0.00000	
4-Wire Detector Heads	0	x	0.00000		0	x	0.00000		0	x	0.00000	
Power SuperVision Relays	0	x	0.02500		0	x	0.02500		0	x	0.02500	
4. Notification Appliances												
NAC #1					1	x	0.91800	0.91800				
NAC #2					0	x	0.00000					
NAC #3					0	x	0.00000					
NAC #4					0	x	0.00000					
TB9 (Non)Resettable (Term 1+2)	0	x	0.00000		0	x	0.00000		0	x	0.00000	
TB9 Resettable (Term 3+4)	0	x	0.00000		0	x	0.00000		0	x	0.00000	
Sum each column for totals			Total Current	0.10500			Total Current	1.17900			Total Current	0.10500

MS-10UD-7 Secondary Battery Calculations

Note: You can edit all current draws and are fully responsible for verifying these calculations. Only enter values in yellow cells.

Secondary Non-Alarm Load (Amps)	0.105 A	x	Required Standby Time	24 Hours	=	2.52 AH
			Required Alarm Time	5 Minutes		
Secondary Alarm Load (Amps)	1.179 A	x		0.084	=	0.10 AH
Standby and Alarm Load Subtotal						2.62 AH
Derating Factor						x 1.2
Total Ampere Hours Required						3.14 AH

Battery Check

The batteries can be housed in the MS-10UD-7 cabinet
An external battery charger is not required for this system

Current Draw Check

NAC#1 current is within the limitations of the circuit.
NAC#2 current is within the limitations of the circuit.
NAC#3 current is within the limitations of the circuit.
NAC#4 current is within the limitations of the circuit.
TB9 (Non)Resettable Power (Terminals 1+2) is within the limitations of the circuit.
TB9 Resettable Power (Terminals 3+4) is within the limitations of the circuit.
The standby current is within the limitations of the panel.
The alarm current is within output limitations of the panel.



Job Name: Amerlcold - Blueberry Buil...
 Amerlcold
 165 Read Street
 Portland, ME 04103
 AHJ: Portland Fire Department

Prepared By:
 Robin Russell
 Protection One
 10 Manuel Drive
 Portland, ME 04103
 (207) 347-5327
 NICET # 110826

Circuit Information

Panel Name: Fire-Lite 10UD-7
 Circuit Name: Blueberry Building
 Starting Voltage: Starting Voltage = 20.4

(1) amp circuit
 Class B @ 14 AWG
 DC 24 - volt Supply

Type and Model	Candela	Current	Tone and Volume	Dist from last device (ft)	Dist from source (ft)	14
Horn/Strobe PC2R	95	0.194	Temporal, High	200	355	19.326
Horn/Strobe PC2R	95	0.194	Temporal, High	35	355	19.181
Strobe SR	15	0.066		40	355	19.065
Horn/Strobe PC2R	95	0.194	Temporal, High	40	355	18.966
Horn/Strobe PC2R	95	0.194	Temporal, High	40	355	18.917
Total current/amps 0.842		Total Dist:355		voltage drop		1.48

4.1 Panel Control Buttons

4.1.1 Acknowledge/Step

The first press of the *Acknowledge/Step* key silences the piezo sounder, changes flashing LEDs to steady and also changes the status field on the LCD display from capital letters to small letters (*TROUBL* to *Troubl*). When the piezo is silenced, an *acknowledge* message is sent to the printer and the history file. *Acknowledge* also sends a *silence piezo* command to the optional annunciators connected to the FACP. The Acknowledge key will have no effect on the Notification Appliance Circuits.

When more than one event exists, the first press of the Acknowledge/Step key functions as described in the preceding paragraph. Subsequent pressing of the key *steps* through each active event.

4.1.2 Alarm Silenced

The *Alarm Silenced* key performs the same functions as Acknowledge/Step except it will not step through each event when multiple events are present at the panel. If an alarm exists, the Alarm Silenced key turns off all silenceable NACs (Notification Appliance Circuits) and causes the Alarm Silenced LED to turn on. It also sends an 'alarm silenced' message to the printer, history file and optional annunciators. A subsequent new alarm will resound the system NACs. The Alarm Silenced LED is turned off by pressing the Reset key, the Drill key or subsequent activation of the NACs.

Note that if Silence Inhibit has been enabled, NACs cannot be silenced for one minute following initiation of an alarm.

4.1.3 Drill/Hold 2 Sec

When the *Drill* key is held for a minimum of two seconds (time required to prevent accidental activations), the FACP turns on all NAC outputs and turns off the Alarm Silenced LED if it was previously on. The *EVAC IN SYSTEM* message is shown on the LCD display. The same message is sent to the printer and history file. The *Alarm Silence* key can be used to turn off all silenceable NAC outputs following activation by the *Drill* key.

4.1.4 Reset

Pressing and releasing the *Reset* key turns off all NACs, temporarily turns off resettable power to 4-wire detectors, causes a *RESET IN SYSTEM* message to be displayed on the LCD and sends the same message to the printer and history file. It also performs a lamp test by turning on all LEDs, piezo sounder and LCD display segments after the *Reset* key is released. Any alarm or trouble that exists after a reset will resound the system.

Note that if Silence Inhibit has been enabled, the FACP cannot be reset for one minute following initiation of an alarm.

4.2 LED Indicators

The five LED indicators, which are located on the front panel, operate as follows:

AC Power

This is a green LED which illuminates if AC power is applied to the FACP. A loss of AC power will turn off this LED.

Fire Alarm

This red LED flashes when one or more alarms occur. It illuminates steady when the *Acknowledge/Step* or *Alarm Silence* key is pressed. The Fire Alarm LED turns off when the *Reset* key is pressed. The LED will remain off if all alarms have been cleared.

Supervisory

This is a yellow LED that flashes when one or more supervisory conditions occur, such as a sprinkler valve tamper condition. It illuminates steady when the *Acknowledge/Step* or *Alarm Silence* key is pressed. It turns off when the *Reset* key is pressed and remains off if all supervisory alarms have been cleared.

Trouble

This is a yellow LED that flashes when one or more trouble conditions occur. It stays on steady when the *Acknowledge/Step* or *Alarm Silence* key is pressed. The LED turns off when all trouble conditions are cleared. This LED will also illuminate if the microprocessor watchdog circuit is activated.

Alarm Silenced

This is a yellow LED that turns on after the *Alarm Silence* key is pressed while an alarm condition exists. It turns off when the *Drill* or *Reset* key is pressed.

4.3 Normal Operation

With no alarms or troubles in the system, the display message is *System All Normal* along with the current time and date as shown below. To set the time and date, refer to the appropriate section in this manual.

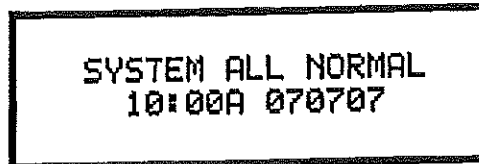

```

SYSTEM ALL NORMAL
10:00A 070707

```

The FACP performs the following functions at regular intervals in Normal mode:

- ✓ Monitors AC input voltage and battery voltage
- ✓ Monitors and reports status option cards and control panel
- ✓ Refreshes LCD display and updates time
- ✓ Scans control panel keypad for key presses
- ✓ Tests memory
- ✓ Updates and reads all communications busses (EIA-485, etc.)
- ✓ If smoke detectors will be polled for maintenance and freeze conditions on initial entry into Normal mode. Thereafter, each device will be polled every hour for freeze and every four hours for maintenance conditions

Note: To ensure that the system is functioning properly, the FACP will perform a freeze check five minutes after the panel is reset, followed by a maintenance check. If there is no freeze or maintenance condition, the panel will continue to monitor for freeze conditions every hour and maintenance conditions every four hours.

4.4 Trouble Operation

With no alarms in the system, the detection of a trouble will cause the following:

- The piezo to pulse 1 second On and 1 second Off
- The system Trouble LED to flash one second On and one second Off
- The trouble relay to activate
- *TROUBL* with device type, noun/adjective, address and trouble description will appear on the LCD display
- The same message, along with the time and date, is sent to the optional printer and the history buffer.
- Communicate the trouble conditions to the Central Station
- Terminate upload or download communications

Note that specific troubles will initiate additional actions; for example, loss of AC power will turn off the AC Power LED, etc.

Input Zone

For Input Zones, the following is a typical message that could appear on the LCD display for a device trouble:

TROUBL PULL STATION
 <ADJ> <NOUN>
 ZONE 10 OPEN FAULT
 10:00A 070707

The information displayed in the above example provides the following information:

- First line in display:
 - ✓ The type of event; in this example *OPEN* indicating a circuit trouble
 - ✓ Device type identifier; in this example, *PULL STATION* indicates a manual device. Other device type identifiers which can be displayed include *SMOKE* for Smoke Detector, *HEAT* for Heat Detector, etc.
- Second line in display:
 - ✓ <ADJ>; refers to the user programmed adjective descriptor from library list resident in the control panel or custom entry via PC.
 - ✓ <NOUN>; refers to the user programmed noun descriptor from library list resident in the control panel or custom entry via PC.
- Third line in display indicates Zone and the fault condition. Other possible troubles include:
 - OPEN* - indicating an open circuit
 - DIRTY* - maintenance alert indicating that an I³ detector is near but below the allowed alarm limit and is in need of maintenance before the performance is compromised
- Fourth line in display:
 - ✓ Time; the current time in this example is *10:00A* which represents 10:00 AM
 - ✓ Date; the current month, day and year in this example is *09* for September, *08* for the 8th day of the month and *07* for the year 2007

Pressing the *Acknowledge/Step* or *Alarm Silence* key will cause the pulsing piezo to silence and the system Trouble LED to change from flashing to on steady. This block acknowledgment occurs regardless of the number of troubles, alarms and supervisory events active in the system. When the *Acknowledge/Step* key is pressed and at least one new alarm or trouble exists in the system, the 'acknowledge' message is sent to the printer and history file. If the trouble clears, either before or after the *Acknowledge/Step* key is pressed, the 'clear trouble' message is sent to the printer and history file.

If all troubles clear and there are no supervisory or fire conditions active in the system, the system returns to normal mode operation and the *System All Normal* message is shown on the LCD display and sent to the history and printer files. The auto-restore feature will restore cleared troubles even if the troubles were never acknowledged. Note that pressing the *Alarm Silence* key when only troubles exist in the system will have the same effect as pressing the *Acknowledge/Step* key except the Alarm Silenced LED will light.

4.5 Alarm Operation

Alarm operation is similar to trouble operation with the following differences:

- The piezo sounder produces a steady output as opposed to a pulsed output
- The Fire Alarm LED flashes 1 second On and 1 second Off
- The LCD displays *Alarm* along with the device name, type, adjective/noun, associated zones and time/date
- Communicate the alarm to the Central Station
- Alarms latch and *are not allowed to clear automatically*
- Timers for Silence Inhibit, Autosilence and Trouble Reminder are started
- Alarms activate the alarm relay
- Silenced alarms are resounded
- The trouble relay is not activated
- Store event in history buffer
- Terminate upload or download communications

A typical alarm display would be as illustrated below:

```

ALARM  PULL STATION
      <ADJ> <NOUN>
ZONE 10
10:00A 070707
  
```

Note that the device type, which in this example is *PULL STATION*, can be any other programmable alarm type.

The information displayed in the above example provides the following information:

- First line in display:
 - ✓ The type of event; in this example *ALARM* indicating an alarm condition
 - ✓ Device type identifier; in this example, *PULL STATION* indicates a manual pull box. Other device type identifiers which can be displayed include *SMOKE* for Smoke Detector, *HEAT* for Heat Detector, etc.
- Second line in display:
 - ✓ <ADJ>; refers to the user programmed adjective descriptor from library list resident in the control panel or custom entry via PC.
 - ✓ <NOUN>; refers to the user programmed noun descriptor from library list resident in the control panel or custom entry via PC.
- Third line in display: *Zone 10* indicates the zone programmed to this device which, in this example, is Input Zone 10.

- Fourth line in display:
 - ✓ Time; the current time in this example is *10:00A* which represents 10:00 AM
 - ✓ Date; the current month, day and year in this example is *09* for September, *08* for the 8th day of the month and *07* for the year 2007

4.6 Supervisory Operation

Supervisory operation is similar to alarm operation but with the following differences:

- The piezo sounder pulses ½ second On and ½ second Off
- The Supervisory LED flashes ½ second On and ½ second Off
- The LCD displays the status label *Active Supervisory* along with the device name, type, adjective/noun, associated zones and time/date
- Communicate the supervisory condition to the Central Station
- The supervisory relay is activated
- The alarm relay is not activated
- Silenced alarms are not resounded
- Timers are not started
- Store event in history buffer
- Terminate upload or download communications

A typical Supervisory event would be displayed as illustrated in the following:

```

FREEZE SUPERVISORY
  <ADJ> <NOUN>
ZONE 05 FROZEN SUPRV
10:00A 070707
  
```

In the preceding example:

- ☐ *FROZEN SUPRV* - indicates zone detector is below approximately 45°F

Note that, like alarms, supervisory signals latch, except when programmed for supervisory autoresettable. Supervisory activations do not cause silenced alarms to resound, as do other alarm conditions. Open circuits in supervisory wiring are processed by the control panel the same way as other trouble conditions. Refer to "Alarm Operation" on page 112, for a description of the information displayed on the control panel LCD.

4.7 Process Monitor Operation

Process Monitor operation will initiate the following events:

- The piezo sounder pulses ¼ second On and ¼ second Off
- The LCD displays a process monitor message along with the device name, type, adjective/noun, associated zones and time/date
- Communicate the process monitor condition to the Central Station
- Relays programmed for process monitoring will be activated
- The alarm relay is not activated
- Silenced alarms are not resounded
- Timers are not started
- Store event in history buffer

Note that, like supervisories, process monitor signals latch, except when programmed for process monitor autoresettable.

4.8 Hazard/Tornado Condition Operation

Hazard/Tornado Condition operation will initiate the following events:

- The piezo sounder pulses ½ second On, ½ second Off
- The LCD displays a hazard message along with the device name, type, adjective/noun, associated zones and time/date
- Communicate the hazard condition to the Central Station
- Relays programmed for hazard will be activated
- The alarm relay is not activated
- Silenced alarms are not resounded
- Timers are not started
- Store event in history buffer
- Supervisory LED flashes ½ second On, ½ second Off

Hazard conditions latch.

4.9 Medical Alert Condition Operation

Medical Alert Condition operation will initiate the following events:

- The piezo sounder ½ second On, ½ second Off
- The LCD displays a medical alert message along with the device name, type, adjective/noun, associated zones and time/date
- Communicate the medical alert condition to the Central Station
- Relays programmed for medical alert will be activated
- The alarm relay is not activated
- Silenced alarms are not resounded
- Timers are not started
- Store event in history buffer
- Supervisory LED flashes ½ second On, ½ second Off

Medical alert conditions latch.

4.10 Disable/Enable Operation

Input zones which are disabled do not cause an alarm or any zone activation. Disabled NACs are held in the off state. All disabled zones/NACs are treated as if they were in trouble, with the exception being the status label that will be displayed is *DISABL*.

4.11 Waterflow Circuits Operation

If an alarm exists from a zone that is a waterflow non-silenceable type, the Alarm Silence key will not function.

4.12 Detector Functions

Maintenance Alert

Smoke detectors will be polled for maintenance and freeze conditions on initial entry into Normal mode. Thereafter, each device will be polled every hour for freeze and every four hours for maintenance conditions. All alarm and system trouble conditions are annunciated on the control panel's LCD.

Note: To ensure that the system is functioning properly, the FACP will perform a freeze check five minutes after the panel is reset, followed by a maintenance check. If there is no freeze or maintenance condition, the panel will continue to monitor for freeze conditions every hour and maintenance conditions every four hours.

System Alarm Verification

The control panel may be programmed to perform alarm verification to help eliminate the nuisance of false alarms. Alarm verification applies to smoke detectors only.

4.13 Time Functions: Real-Time Clock

The FACP includes a crystal-based clock that provides time of day, date and day of week. Time is displayed as 12 or 24 hour time with month/day/year and is stored in RAM. Daylight savings time change-over is programmable and automatic. If both AC and battery are lost, the time must be reprogrammed.

4.14 Coded Operation

The NAC circuits resident on the control panel main circuit board can be programmed for coded operation. The available pulse rates which can be programmed for coded operation are as follows:

- Continuous: Steady output with no pulsing
- March Time: Pulses at 120 ppm (pulses per minute)
- Temporal Code: Pulses at ½ second On, ½ second Off, ½ second On, ½ second Off, ½ second On, 1½ second Off
- California Code: 10 seconds On, 5 seconds Off
- Two-Stage: Pulses at 20 ppm (pulses per minute) for 3 or 5 minutes and then changes to Temporal

MS-5UD/MS-10UD(E) Series

Five Zone Fire Alarm Control Panel
Ten Zone Fire Alarm Control Panel

 **FIRE-LITE Alarms**
by Honeywell

Control/Communicators

General

The MS-5UD-3 is a five-zone FACP (Fire Alarm Control Panel) and the MS-10UD-7(E) is a ten-zone FACP. These control panels provide reliable fire signaling protection for small to medium-sized commercial, industrial, and institutional buildings. Both panels include built-in communicators for Central Station Service and remote upload/download.

Each of these FACP's is compatible with System Sensor's microprocessor-based I³ series detectors. These conventional smoke detectors can transmit a maintenance trouble signal to the FACP indicating the need for cleaning and a supervisory "freeze" signal when the ambient temperature falls below the detector rating. Additionally, both the MS-5UD-3 and MS-10UD-7 are compatible with conventional input devices such as two- and four-wire smoke detectors, pull stations, waterflow devices, tamper switches, and other normally-open contact devices. Refer to the *Fire-Lite Device Compatibility Document* for a complete listing of compatible devices.

Outputs include four NACs (Notification Appliance Circuits), three programmable Form-C relays (factory programmed for Alarm, Trouble, and Supervisory) and 24 VDC special application resettable and nonresettable power outputs. The FACP's supervise all wiring, AC voltage, battery level and telephone line integrity.

Activation of a compatible smoke detector or any normally-open fire alarm initiating device will activate audible and visual signaling devices, illuminate an indicating LED, sound the piezo sounder at the FACP, activate the communicator and FACP alarm relay, and operate an optional module used to notify a remote station or initiate an auxiliary control function.

New options include a UL listed printer, PRN-6F and FireLite's ACT Internet Monitoring module. The FireWatch Series Internet monitoring modules IPDACT-2 and IPDACT-2UD permit monitoring of alarm signals over the Internet saving the monthly cost of two telephone lines. Although not required, the secondary telephone line may be retained providing backup communication over the public switched telephone line.

NOTE: The MS-10UD-7E offers the same features as the MS-10UD-7 but allows connection to 240 VAC. Unless otherwise specified, the information in this data sheet applies to both the 120 VAC and the 240 VAC versions of these panels.

NOTE: For ULC-listed models, see df-60440.

Features

- Listed to UL Standard 864, 9th edition.
- Built-in DACT (Digital Alarm Communicator/Transmitter).
- Style B (Class B) IDC (Initiating Device Circuit)
 - MS-5UD-3 - five IDCs.
 - MS-10UD-7 - ten IDCs.
- Style Y (Class B) NAC (Notification Appliance Circuit) - special application power
 - MS-5UD-3 - four NACs.
 - MS-10UD-7 - four NACs.
- Notification Appliances may be programmed as
 - Silence Inhibit.
 - Auto-Silence.

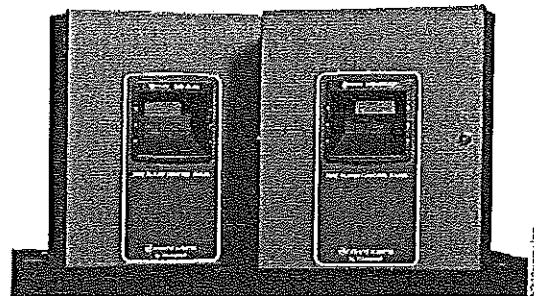

- Strobe Synchronization for System Sensor, Wheelock, Gentex, Faraday, or Amseco devices.
- Selective Silence (horn-strobe mute).
- Temporal or Steady Signal.
- Silenceable or Nonsilenceable.
- Optional CAC-5X Style Z (Class A) Converter Module for NACs and IDCs (2 required for MS-10UD-7).
- Form-C Relays for Alarm, Trouble and Supervisory - Contact Ratings 2.0 A @ 30 VDC or 30 VAC (resistive).
- 3.0 A total system current for MS-5UD-3.
- 7.0 A total system current for MS-10UD-7.
- Optional Dress Panel DP-51050
- Optional Trim Ring TR-CE for semi-flush mounting.
- 24 volt operation.
- Low AC voltage sense.
- Alarm Verification.
- PAS (Positive Alarm Sequence).
- Automatic battery trickle charger.
- Up to eight ANN-BUS annunciators:
 - Optional 8 zone Relay Module ANN-RLY.
 - Optional LED Annunciator Module ANN-LED.
 - Optional Remote Annunciator ANN-80.
 - Optional Remote Printer Gateway ANN-S/PG.
 - Optional LED Annunciator Driver ANN-I/O.
- Optional 4XTMF module (conventional reverse polarity/city box transmitter).

PROGRAMMING AND SOFTWARE:

- Can be programmed at the panel with no special software or additional equipment.
- Programmable Make/Break Ratio.
- Upload/Download (local or remote) of program and data via Integral DACT.

USER INTERFACE:

- Built-in DACT (Digital Alarm Communicator/Transmitter).
- Integral 80-character LCD display with backlighting and keypad.
- Real-time clock/calendar with automatic daylight savings adjustments.
- ANN-BUS for connection to remote annunciators.
- Audible or silent walk test capabilities.
- Piezo sounder for alarm, trouble, and supervisory.

Controls and Indicators

LED INDICATORS

- FIRE ALARM (red)
- SUPERVISORY (yellow)
- TROUBLE (yellow)
- AC POWER (green)
- ALARM SILENCED (yellow)

CONTROL BUTTONS

- ACKNOWLEDGE
- ALARM SILENCE

- SYSTEM RESET (lamp test)
- DRILL

Terminal Blocks

AC Power – TB1:

- MS-5UD-3 (FLPS-3 Power Supply): 120 VAC, 50/60 HZ, 1.00 A.
- MS-10UD-7 (FLPS-7 Power Supply): 120 VAC, 50/60 HZ, 3.80 A.
- MS-10UD-7E (FLPS-7 Power Supply): 240 VAC, 50 HZ, 2.20 A.

Wire size: minimum 14 AWG (2.00 mm²) with 600 V Insulation, Supervised, nonpower-limited.

Battery (sealed lead acid only) – J12:

- Maximum Charging Circuit - Normal Flat Charge: 27.6 VDC @ 1.4 A, Supervised, nonpower-limited.
- Maximum Charger Capacity: 18 AH battery for MS-5UD-3, and 26 AH battery for MS-10UD-7(E). [Two 18 Ah batteries can be housed in the FACP cabinet. Larger batteries require separate battery box such as the BB-26 or BB-55.]
- Minimum Battery Size: 7 AH.

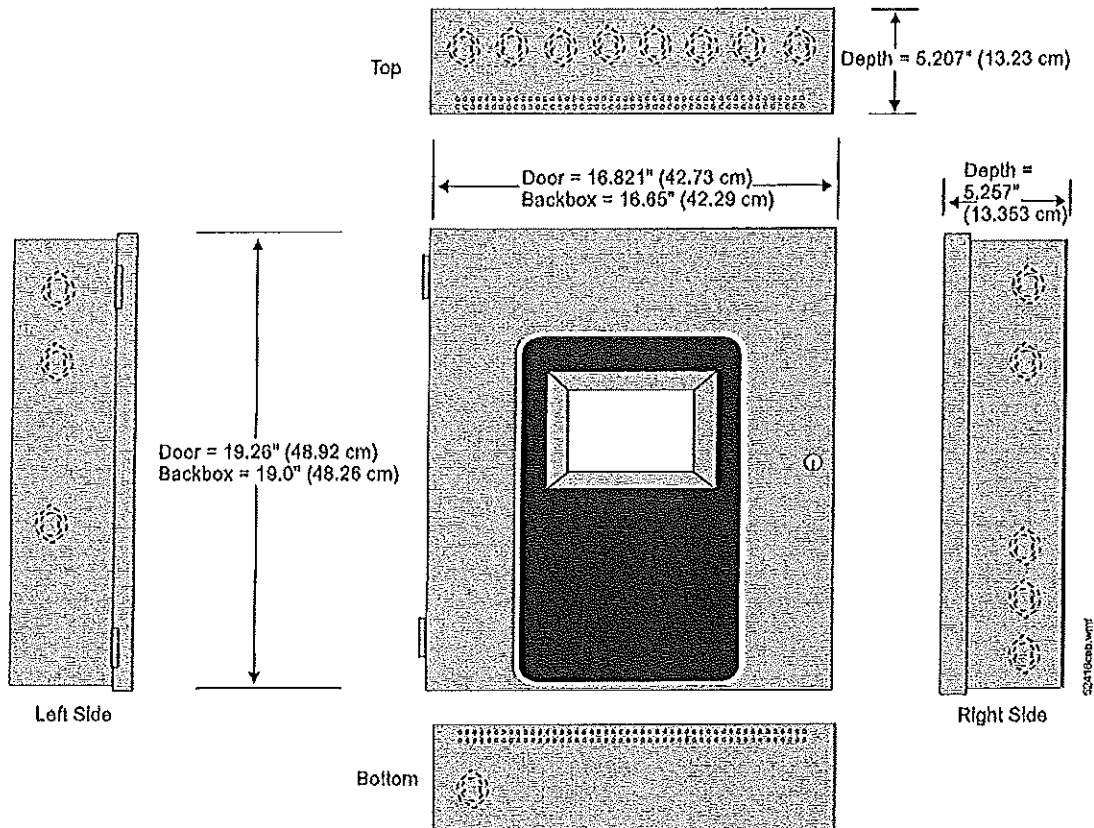

Cabinet Measurements

Initiating Device Circuits – TB4 (and TB 6 on MS-10UD-7 only):

- Alarm Zones 1 - 5 on TB 4 (MS-5UD-3 and MS-10UD-7).
- Alarm Zones 6 - 10 on TB6 (MS-10UD-7 only).
- Supervised and power-limited circuitry.
- Operation: All zones Style B (Class B).
- Normal Operating Voltage: Nominal 20 VDC.
- Alarm Current: 15 mA minimum.
- Short Circuit Current: 40 mA max.
- Maximum Loop Resistance: 100 ohms.
- End-of-Line Resistor: 4.7K ohm, 1/2 watt (P/N 71252 UL-listed).
- Standby Current: 2 mA.

Refer to the *Fire-Lite Device Compatibility Document* for listed compatible devices.

Notification Appliance Circuits – TB5 (and TB 7 on MS-10UD-7 only):

- Four NACs
- Operation: Style Y (Class B)
- Special Application power
- Supervised and power-limited circuitry
- Normal Operating Voltage: Nominal 24 VDC
- Maximum Signalling Current: 3.0 A for MS-5UD-3, 2.5 A maximum per NAC; 7.0 A for MS-10UD-7(E), 3.0 A maximum per NAC.
- End-of-Line Resistor: 4.7K ohm, 1/2 watt (Part #71252)
- Max. Wiring Voltage Drop: 2 VDC

Refer to the *Fire-Lite Device Compatibility Document* for compatible listed devices.

Form C Relays – TB8:

- *Relay 1* (factory default programmed as Alarm Relay)
- *Relay 2* (factory default programmed as fail-safe Trouble Relay)
- *Relay 3* (factory default programmed as Supervisory Relay)

Special Application Resettable Power – TB9:

- Jumper selectable by JP31 for resettable or nonresettable power.
- Operating voltage: 24 VDC nominal.
- Maximum available current: 500 mA - appropriate for powering four-wire smoke detectors.
- Power-limited circuit.

Refer to the *Fire-Lite Device Compatibility Document* for listed compatible devices.

Remote Sync Output - TB2: Remote power supply synchronization output, only required for the MS-5UD-3. 24 VDC nominal special application power. Maximum current is 40 mA. End-of-Line Resistor: 4.7K ohm. Supervised and power-limited circuit.

Product Line Information

MS-5UD-3: Five-zone, 24-volt Fire Alarm Control Panel (includes backbox, FLPS-3 power supply, technical manual, and a frame & post operating instruction sheet).

MS-10UD-7: Ten-zone, 24-volt Fire Alarm Control Panel (includes backbox, FLPS-7 power supply, technical manual, and a frame & post operating instruction sheet).

MS-10UD-7E: Same as above with 240 VAC FLPS-7.

IPDACT, IPDACT-2/2UD Internet Monitoring Module: Mounts in bottom of enclosure with optional mounting kit (PN IPBRKT). Connects to primary and secondary DACT tele-

phone output ports for Internet communications over customer provided ethernet internet connection. Requires compatible Teldat Visoralarm Central Station Receiver. Can use DHCP or static IP. (See data sheet df-52424 for more information.)

IPBRKT: Mounting kit for IPDACT in common enclosure.

IPSPLT: Y Adaptor option to allow connection of both panel dialer outputs to one cable input to IPDACT (sold separately).

OPTIONAL MODULES

CAC-5X: Optional (Class A) Converter Module. Converts Style B (Class B) Initiating Device Circuits to Style D (Class A); and Style Y (Class B) Notification Appliance Circuits to Style Z (Class A). Connects to J2 on the MS-5UD-3 and MS-10UD-7(E) main circuit board and to J7 on the MS-10UD-7(E).

NOTE: Two Class A Converter Modules are required for the ten-zone panel.

4XTMF: Transmitter module. Provides a supervised output for local energy municipal box transmitter and alarm and trouble reverse polarity. Includes a disable switch and disable trouble LED. A module jumper option allows the reverse polarity circuit to open with a system trouble condition if no alarm conditions exist. Mounts to the main circuit board connectors J4 and J5.

COMPATIBLE ANNUNCIATORS

ANN-80: Remote LCD Annunciator. Mimics the information displayed on the FACP's LCD. Red. (For white, order: ANN-80-W.)

ANN-LED: LED Annunciator with three LEDs for each zone: Alarm, Trouble, and Supervisory. Mounts in the DP-51050(B) dress panel. (For white, order: ANN-80-W.)

ANN-ILED: LED Annunciator with three alarm (red) indicators for up to 30 input zones or addressable points. (See DF-60241).

ANN-RLY: Relay module. Mounts inside the cabinet. Provides ten Form C relays.

ANN-S/PG: Serial/parallel printer gateway. Provides a connection for a serial or parallel printer.

ANN-I/O: Driver module. Provides connections to a user-supplied graphic annunciator.

ACCESSORIES

DP-51050: Optional dress panel. Restricts access to the system wiring while allowing access to the membrane switch panel.

BB-26: Battery backbox, holds up to two 26 AH batteries and CHG-75.

BB-55: Battery backbox, holds up to two 26 AH batteries.

TR-CE: Optional trim-ring for semi-flush mounted cabinets.

PRN-6F: UL listed printer.

SYSTEM SPECIFICATIONS

System Capacity

- Annunciators 8

Electrical Specifications

- MS-5UD-3 (FLPS-3 Power Supply): 120 VAC, 60 HZ, 1.0 A
- MS-10UD-7 (FLPS-7 Power Supply): 120 VAC, 60 HZ, 3.90 A
- MS-10UD-7E (FLPS-7 Power Supply): 240 VAC, 60 HZ, 2.20 A.
- Wire size: minimum 14 AWG (2.0 mm²) with 600 V insulation, supervised, nonpower-limited

Cabinet Specifications

Door: 19.28" (48.92 cm.) high x 16.82" (42.73 cm.) wide x 0.72" (1.82 cm.) deep. Backbox: 19.00" (48.26 cm.) high x 16.65" (42.29 cm.) wide x 5.25" (13.34 cm.) deep. Trim Ring (TR-CE): 22.00" (55.88 cm.) high x 19.65" (49.91 cm.) wide.

Shipping Specifications

Dimensions:

- 20.00" (50.80 cm.) high
- 22.5" (57.15 cm.) wide
- 8.5" (21.59 cm.) deep.

Weight: 27 lb (12.20 kg)

Temperature and Humidity Ranges

This system meets NFPA requirements for operation at 0 – 49°C/32 – 120°F and at a relative humidity 93% ± 2% RH (noncondensing) at 32°C ± 2°C (90°F ± 3°F). However, the useful life of the system's standby batteries and the electronic components may be adversely affected by extreme temperature ranges and humidity. Therefore, it is recommended that this system and its peripherals be installed in an environment with a normal room temperature of 15 – 27°C/60 – 80°F.

Agency Listings and Approvals

The listings and approvals below apply to the basic MS-5UD-3 and MS-10UD-7 control panels. In some cases, certain modules or applications may not be listed by certain approval agencies, or listing may be in process. Consult factory for latest listing status.

- UL Listed: File S624
- FM Approved
- CSFM: 7165-0075:214
- MEA: MEA: 333-07-E

NOTE: For ULC-listed models, see df-60440.

NFPA Standards

The MS-5UD/MS-10UD(E) Series complies with the following NFPA 72 Fire Alarm Systems requirements:

- LOCAL (Automatic, Manual, Waterflow and Sprinkler Supervisory).
- AUXILIARY (Automatic, Manual and Waterflow) (requires 4XTMF).
- REMOTE STATION (Automatic, Manual and Waterflow) (Where a DACT is not accepted, the alarm, trouble and supervisory relays may be connected to UL 884 listed transmitters. For reverse polarity signaling of alarm and trouble, 4XTMF is required.)
- PROPRIETARY (Automatic, Manual and Waterflow).
- CENTRAL STATION (Automatic, Manual and Waterflow, and Sprinkler Supervised).
- OT, PSDN (Other Technologies, Packet-switched Data Network)

FireLite® Alarms and System Sensor® are registered trademarks of Honeywell International Inc.

©2009 by Honeywell International Inc. All rights reserved. Unauthorized use of this document is strictly prohibited.



This document is not intended to be used for installation purposes.
We try to keep our product information up-to-date and accurate.
We cannot cover all specific applications or anticipate all requirements.
All specifications are subject to change without notice.



Made in the U.S.A.

For more information, contact FireLite Alarms. Phone: (800) 627-3473, FAX: (877) 699-4105.
www.firelite.com



5600 Series Mechanical Heat Detectors

System Sensor's 5600 series mechanical heat detectors offer a low-cost means for property protection against fire, and for non-life-safety installations where smoke detectors are inappropriate.

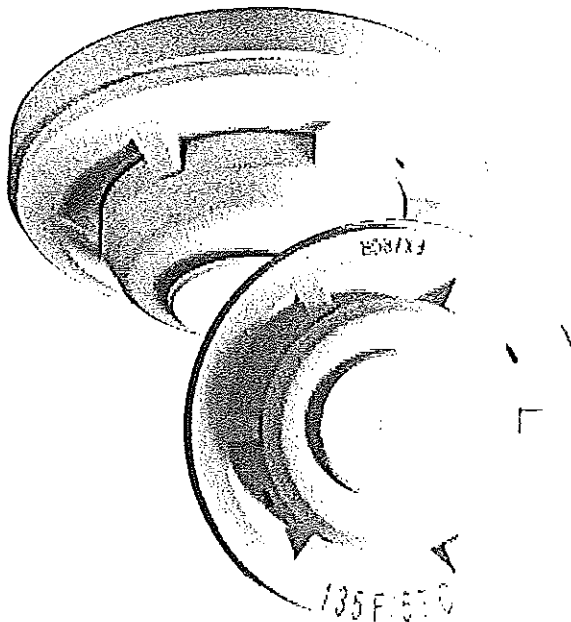

Features

- Multiple configurations for installations:
 - Single- and dual-circuit models
 - Fixed temp and combination fixed- temp/rate-of-rise 135°F or 194°F ratings.
- Plain housing for residential installations (Model 5601P)
- Easy-to-use terminal screws
- A broad range of back box mounting options:
 - Single gang
 - 3.5" and 4" Octagonal
 - 4" square with square to round plaster ring
- Reversible mounting bracket

Multiple configurations. The 5600 series offers a full-line of configurations to accommodate a broad range of applications. Both single- and dual-circuit models are available for low- and high-temperature ratings with either fixed temperature or combination fixed temperature/rate-of-rise (ROR) activation. The ROR element of the fixed/ROR models is restorable to accommodate field-testing.

Installation flexibility. To satisfy a variety of installation needs, the 5600 series easily mounts to single-gang and octagonal back boxes. And these models accommodate four-square back boxes, when used with a square to round plaster ring. The reversible mounting bracket permits both flush- and surface-mount back box installations.

Visual identification. The 5600 series provides clear markings on the exterior of the unit to ensure that the proper detector is being used. Alphanumeric characters identify the activation method, as well as the temperature rating, in Fahrenheit and Celsius degrees. Fixed temperature models are identified FX, while combination fixed/rate-of-rise units are marked FX/ROR. The 5600 series also provides a post-activation indicator in the form of a collector. When the detector is activated, the collector drops from the unit, making it easy to identify the unit in alarm.

Agency Listings



Specifications

Architectural/Engineering Specifications

Mechanical heat detector shall be a System Sensor 5600 series model number _____, listed to Underwriters Laboratories UL 521 for Heat Detectors for Fire Protective Signaling Systems. The detector shall be either a single-circuit or a dual-circuit type, normally open. The detector shall be rated for activation at either 135°F (57°C) or 194°F (90°C), and shall activate by means of a fixed temperature thermal sensor, or a combination fixed temperature/rate-of-rise thermal sensor. The rate-of-rise element shall be activated by a rapid rise in temperature, approximately 15°F (8.3°C) per minute. The detector shall include a reversible mounting bracket for mounting to 3½-inch and 4-inch octagonal, single gang, and 4-inch square back boxes with a square to round plaster ring. Wiring connections shall be made by means of SEMS screws that shall accommodate 14–22 AWG wire. The detector shall contain alphanumeric markings on the exterior of the housing to identify its temperature rating and activation method. The rate-of-rise element of combination fixed temperature/rate-of-rise models shall be restorable, to allow for field-testing. The detectors shall include an external collector that shall drop upon activation to identify the unit in alarm.

Physical/Operating Specifications

Maximum Installation Temperature	5601P, 5603, 5621, and 5623: 100°F (38°C) 5602, 5604, 5622, and 5624: 150°F (65.6°C)
Operating Humidity Range	5 to 95% RH non-condensing
Dimensions with mounting bracket	Diameter: 4.57 Inches (11.6cm) Height: 1.69 Inches (4.3cm)
Alarm Temperature	5601P, 5603, 5621, and 5623: 135°F (57°C) 5602, 5604, 5622, and 5624: 194°F (90°C)
Weight	6 oz. (170 grams)
Rate-of-Rise Threshold	15°F (8.3°C) rise per minute (models 5601P, 5602, 5621, and 5622 only)
Mounting	3½-inch octagonal back box 4-inch octagonal back box Single gang back box 4-inch square back box with a square to round plaster ring

Electrical Specifications

Operating Voltage / Contact Ratings	6–125VAC / 3A 6–28VDC / 1A 125VDC / 0.3A 250VDC / 0.1A
Input Terminals	14–22 AWG

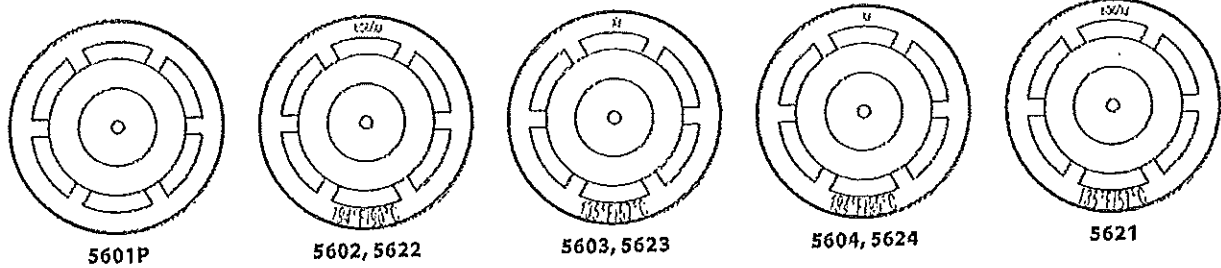

Ordering Information

Model	Circuit	Identification Method on Exterior	Temperature Rating	Activation	UL Protected Spacing – 10 Foot Ceiling*
5601P	Single	None	135°F (57°C)	Fixed Temperature / Rate-of-Rise	50 feet x 50 feet (15.24m x 15.24m)
5602	Single	Lettering	194°F (90°C)	Fixed Temperature / Rate-of-Rise	50 feet x 50 feet (15.24m x 15.24m)
5603	Single	Lettering	135°F (57°C)	Fixed Temperature	25 feet x 25 feet (7.62m x 7.62m)
5604	Single	Lettering	194°F (90°C)	Fixed Temperature	25 feet x 25 feet (7.62m x 7.62m)
5621	Dual	Lettering	135°F (57°C)	Fixed Temperature / Rate-of-Rise	50 feet x 50 feet (15.24m x 15.24m)
5622	Dual	Lettering	194°F (90°C)	Fixed Temperature / Rate-of-Rise	50 feet x 50 feet (15.24m x 15.24m)
5623	Dual	Lettering	135°F (57°C)	Fixed Temperature	25 feet x 25 feet (7.62m x 7.62m)
5624	Dual	Lettering	194°F (90°C)	Fixed Temperature	25 feet x 25 feet (7.62m x 7.62m)

*NOTE: Refer to NFPA72 guidelines for spacing reductions when ceiling heights exceed 10 feet.



3825 Ohio Avenue • St. Charles, IL 60174
Phone: 800-SENSOR2 • Fax: 630-377-6495

©2006 System Sensor.
Product specifications are subject to change without notice. Visit www.systemsensor.com for current product information, including the latest version of this data sheet.
A06-0351-022 • 11/06 • #1676

A U D I B L E / V I S I B L E N O T I F I C A T I O N

SPECTRAlert

Ceiling Mount Series Strobes and Horn/Strobes



Models Available

Strobe Models

White	Red
SC2415W	SC2415
SC241575W	SC241575
SC2430W	SC2430
SC2475W	SC2475
SC2495W	SC2495
SC24115W	SC24115
SC24177W	SC24177

Horn/Strobe Models

White	Red
PC2415W	PC2415
PC241575W	PC241575
PC2430W	PC2430
PC2475W	PC2475
PC2495W	PC2495
PC24115W	PC24115
PC24177W	PC24177

Accessory Mounting Plates

White	Red
BBSCW	BBSC

SC241575W



PC2475W

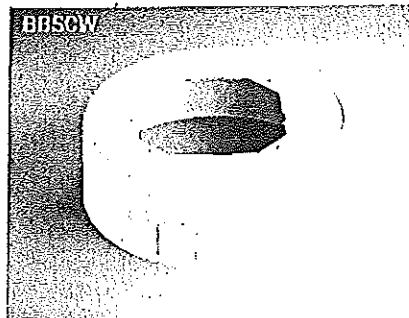

Product Overview

Lower current draw

Available in 15, 15/75, 30, 75, 95, 115, and 177 candela

Horn/strobe models include a three position switch for field-selecting horn tones:

- Electromechanical/3KHz
- Temporal 3/Non-temporal 3
- High/Low dBA output

Ceiling-specific shape, profile, and aesthetics

Synchronizable with MDL Sync • Circuit™ module

Mounts to 4"x4"x1½" back box

Round shape offers greater placement flexibility

System Sensor's SpectrAlert® ceiling mount series strobes and horn/strobes offer a fresh approach to addressing the unique needs for ceiling mount applications.

Technology. Like the original SpectrAlert, the SpectrAlert ceiling mount series offer significant current draw reductions over other ceiling mount strobes and horn/strobes.

Installation. SpectrAlert's compact design also offers installation savings. The strobe and horn/strobe models mount to a 4"x4"x1½" back box, and take up little room in the back box, making connections easier. And with SpectrAlert's round shape, it is not necessary to align the back box with the room's walls. SpectrAlert always lines up.

Flexibility. SpectrAlert ceiling mount strobes and horn/strobes are available in seven different candelas, including 177 candela for sleeping areas. The horn/strobe's tones are field-selectable through the use of a three position switch located on the back of the unit. Selections include electromechanical and 3 KHz tones, temporal 3 and non-temporal 3 patterns, and high and low volume.

Aesthetics. SpectrAlert ceiling strobes and horn/strobes offer a design that is sensitive to the aesthetic demands of ceiling mount applications. The round shape maintains a low profile appearance, similar to that of a smoke detector. Its stylish curves and design further refine the aesthetics over other generic wall/ceiling mount designs. Yet SpectrAlert's round shape provides clearly visible "FIRE" identification from all angles.



Engineering Specifications

Strobe

Strobe shall be a System Sensor SpectrAlert Model _____ listed to UL 1971 and be approved for fire protective service where ceiling mount strobes are permitted. The strobe shall be wired as a primary signaling notification appliance and shall flash at 1Hz over the strobe's entire operating range. The strobe light shall consist of a xenon flash tube and associated lens/reflector system.

Horn/Strobe Combination

Horn/strobe shall be a System Sensor SpectrAlert Model _____ listed to UL 1971 and UL 464 and be approved for fire protective service where ceiling mount horn/strobes are permitted. The horn/strobe shall be wired as a primary signaling notification appliance and shall flash at 1Hz over its entire operating range. The strobe light shall consist of a xenon flash tube and associated lens/reflector system. The horn shall have two tone options, two audibility options, and the option to switch between a temporal 3 pattern and a non-temporal continuous pattern. These options shall be selected by a multi-position switch. Strobes shall be powered independently of the sounder with the removal of factory installed jumper wires. The horn on horn/strobe models shall operate on a coded or non-coded power supply.

Note: The strobes must be powered continuously for the horn to operate.

General Specifications

Dimensions	Indoor Operating Temperature	Weight
6.8" diameter	32° to 120° F (0° to 49°C)	5.3 oz. (150 grams)
Mounting	Max. Humidity	
4"x4"x1½" back box	95% as tested per UL464	

SpectrAlert Mounting Diagrams

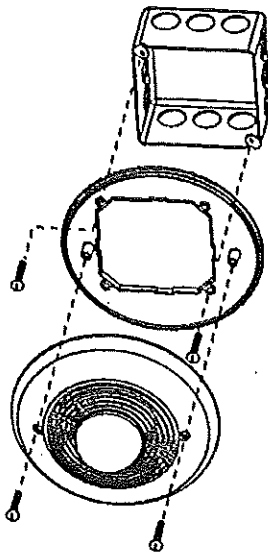

Strobe or Horn/Strobe with Mounting Plate

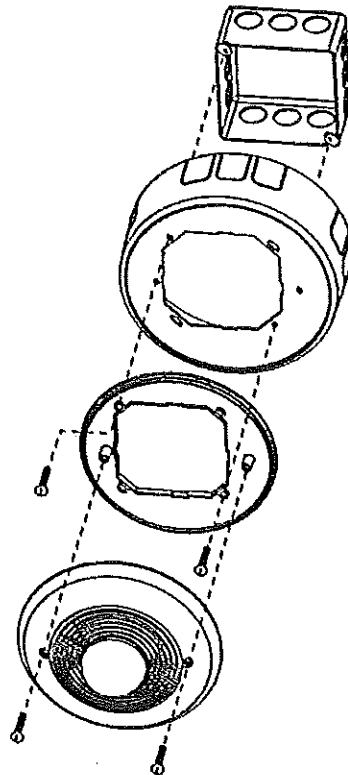

Strobe or Horn/Strobe with Accessory Back Box Skirt

Electrical Specifications

Operating Voltage 24 VDC and FWR unfiltered	Operating Voltage Range w/Sync • Circuit Module 24V, 17-33 V	U.S. Patent Numbers 6,049,446 6,057,778 D424,465
Input Terminals 12 to 18 AWG	Note: 177cd models tested at 21-33 V FWR and 17-33 VDC	
Operating Voltage Range 24V, 16-33 V Note: 177cd models tested at 20-33 V FWR and 16-33 VDC		

Current Draw

NOTE: All SC and PC strobes were only tested at the 16-33 Volt-FWR/DC limits. This does not include the 80% low end or 110% high end voltage limits.

	Model No.		Voltage	Candela	FWR Max. Operating Current - Strobe (mA RMS)	DC Max. Operating Current - Strobe (mA RMS)	FWR Max. Operating Current - Horn (mA RMS)	DC Max. Operating Current - Horn (mA RMS)	Horn Audibility (dBA)	
	Red	White								
Ceiling-mount Strobes	SC2415	SC2415W	24	15	68	64				
	SC241575	SC241575W	24	15/75	77	78				
	SC2430	SC2430W	24	30	107	113				
	SC2475	SC2475W	24	75	197	205				
	SC2495	SC2495W	24	95	239	274				
	SC24115	SC24115W	24	115	298	325				
	SC24177	SC24177W	24	177	399	489				
Ceiling-mount Horn/Strobes*	PC2415	PC2415W	24	15	68	64	57.5	57	75	
	PC241575	PC241575W	24	15/75	77	78	57.5	57	75	
	PC2430	PC2430W	24	30	107	113	57.5	57	75	
	PC2475	PC2475W	24	75	197	205	57.5	57	75	
	PC2495	PC2495W	24	95	239	274	57.5	57	75	
	PC24115	PC24115W	24	115	298	325	57.5	57	75	
	PC24177	PC24177W	24	177	399	489	57.5	57	75	
Sync • Circuit™ Module	MDL	MDLW	Average Current (mA)		Peak Current (mA)		In-rush Current (mA)			
			DC	FWR	DC	FWR	DC	FWR		

*Horn/strobe current draws assume horn is set at temporal 3, electromechanical tone, and high audibility.

Selectable Horn Tones

Temporal	Low Volume	Electromechanical 3000 Hz Interrupted
	High Volume	Electromechanical 3000 Hz Interrupted
Non-Temporal	Low Volume	Electromechanical 3000 Hz Interrupted
	High Volume	Electromechanical 3000 Hz Interrupted

SpectraAlert Dimensions

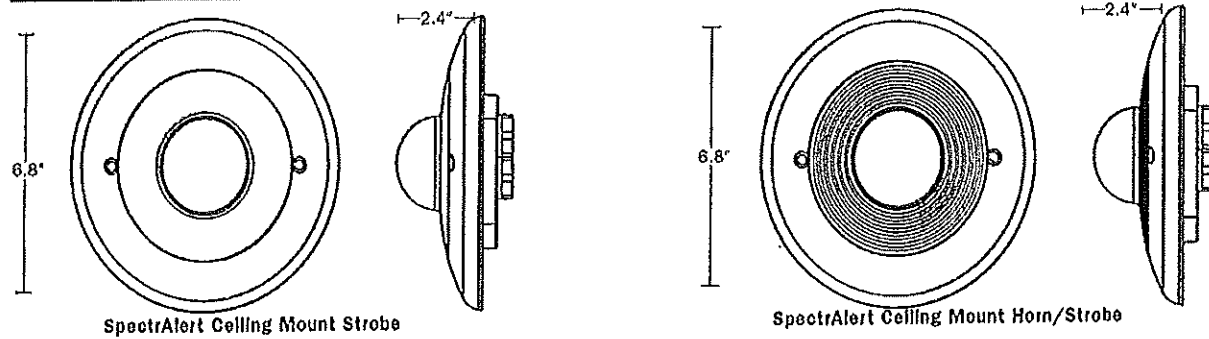

Ordering Information

Model No.	Description
SC2415	Ceiling-mount strobe, 24 volt, 15 candela, red
SC2415W	Ceiling-mount strobe, 24 volt, 15 candela, white
SC241575	Ceiling-mount strobe, 24 volt, 15/75 candela, red
SC241575W	Ceiling-mount strobe, 24 volt, 15/75 candela, white
SC2430	Ceiling-mount strobe, 24 volt, 30 candela, red
SC2430W	Ceiling-mount strobe, 24 volt, 30 candela, white
SC2475	Ceiling-mount strobe, 24 volt, 75 candela, red
SC2475W	Ceiling-mount strobe, 24 volt, 75 candela, white
SC2495	Ceiling-mount strobe, 24 volt, 95 candela, red
SC2495W	Ceiling-mount strobe, 24 volt, 95 candela, white
SC24115	Ceiling-mount strobe, 24 volt, 115 candela, red
SC24115W	Ceiling-mount strobe, 24 volt, 115 candela, white
SC24177	Ceiling-mount strobe, 24 volt, 177 candela, red
SC24177W	Ceiling-mount strobe, 24 volt, 177 candela, white
PC2415	Ceiling-mount horn/strobe, 24 volt, 15 candela, red
PC2415W	Ceiling-mount horn/strobe, 24 volt, 15 candela, white
PC241575	Ceiling-mount horn/strobe, 24 volt, 15/75 candela, red
PC241675W	Ceiling-mount horn/strobe, 24 volt, 15/75 candela, white
PC2430	Ceiling-mount horn/strobe, 24 volt, 30 candela, red
PC2430W	Ceiling-mount horn/strobe, 24 volt, 30 candela, white
PC2475	Ceiling-mount horn/strobe, 24 volt, 75 candela, red
PC2475W	Ceiling-mount horn/strobe, 24 volt, 75 candela, white
PC2495	Ceiling-mount horn/strobe, 24 volt, 95 candela, red
PC2495W	Ceiling-mount horn/strobe, 24 volt, 95 candela, white
PC24115	Ceiling-mount horn/strobe, 24 volt, 115 candela, red
PC24115W	Ceiling-mount horn/strobe, 24 volt, 115 candela, white
PC24177	Ceiling-mount horn/strobe, 24 volt, 177 candela, red
PC24177W	Ceiling-mount horn/strobe, 24 volt, 177 candela, white
Accessories	
MDL	Sync • Circuit™ Module, red
MDLW	Sync • Circuit™ Module, white
BBSC	Surface-mount back box skirt, red
BBSCW	Surface-mount back box skirt, white

System Sensor Sales and Service

System Sensor Headquarters
 3825 Ohio Avenue
 St. Charles, IL 60174
 Ph: 800/SENSOR2
 Fx: 630/377-6495
 Documents on Demand
 800/736-7672 x3
 www.systemsensor.com

System Sensor Canada
 Ph: 905.812.0767
 Fx: 905.812.0771

System Sensor Europe
 Ph: 44.1403.891920
 Fx: 44.1403.891921

System Sensor In China
 Ph: 86.29.524.6253
 Fx: 86.29.524.6259

System Sensor In Singapore
 Ph: 65.6273.2230
 Fx: 65.6273.2610

System Sensor - Far East
 Ph: 85.22.191.9003
 Fx: 85.22.736.6580

System Sensor - Australia
 Ph: 613.54.281.142
 Fx: 613.54.281.172

System Sensor - India
 Ph: 91.124.237.1770 x.2700
 Fx: 91.124.237.3118

System Sensor - Russia
 Ph: 70.95.937.7982
 Fx: 70.95.937.7983