

145-B-42

746 Stevens

Ave

Conditional Use

UNE

L:\PROJECTS\2000031\2000031 C4.dwg Tue Nov 07 13:06:21 2000 COPYRIGHT 2000 TAYLOR ENGINEERING ASSOCIATES

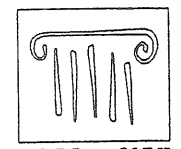
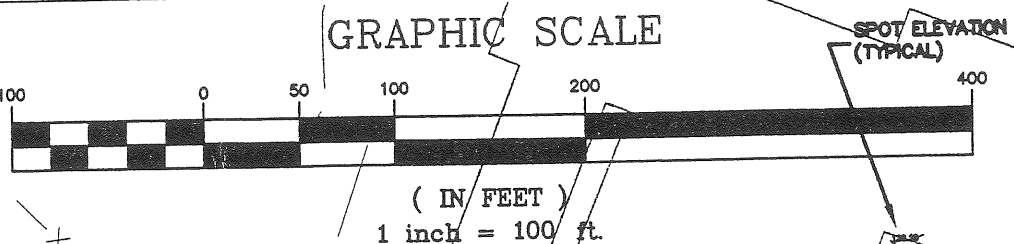
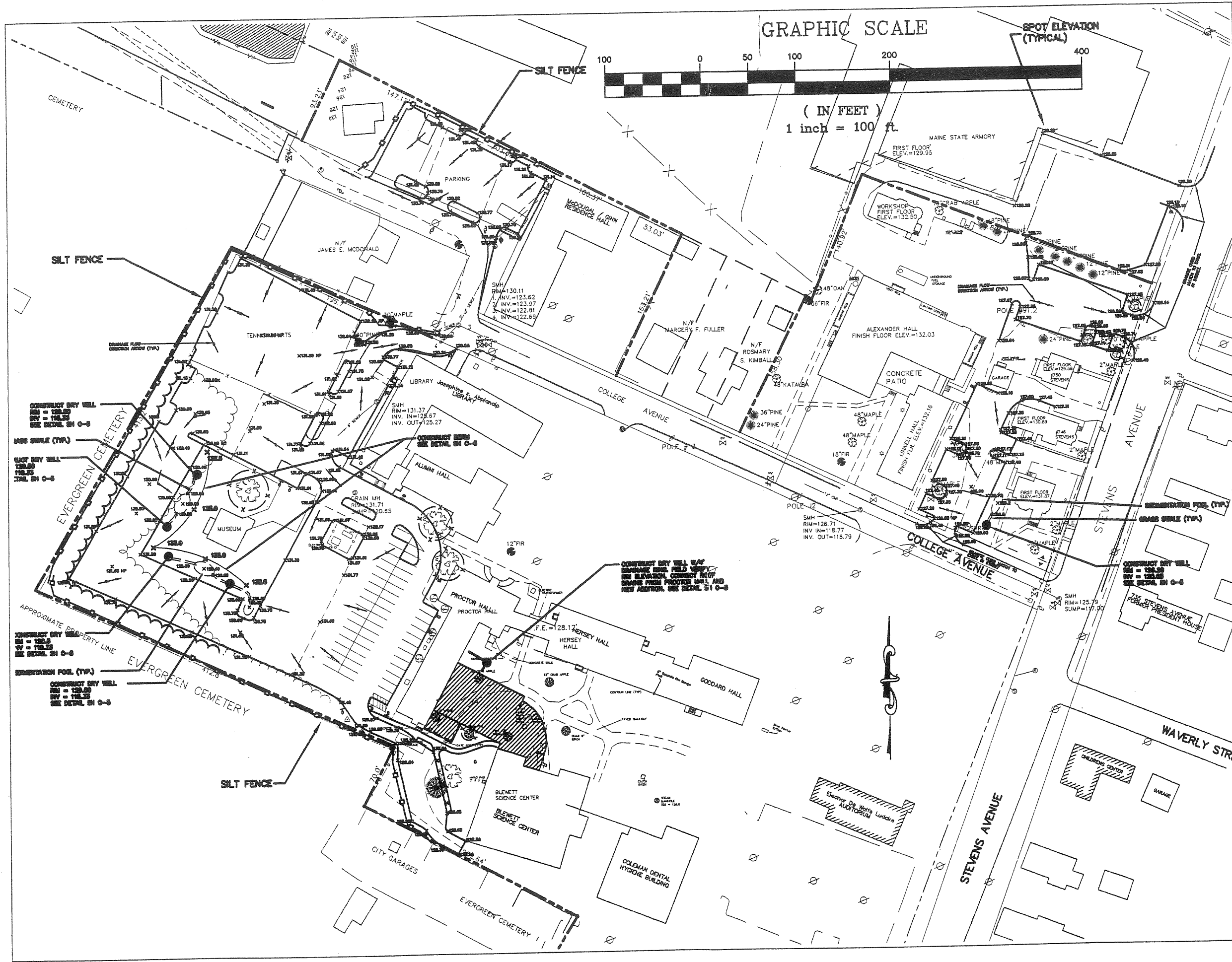

PORT CITY ARCHITECTURE  
66 NEWBURY STREET  
PORTLAND, ME 04101  
207.761.9000  
fax: 761.2010  
info@portcityarch.com

© COPYRIGHT  
Reuse or reproduction of the contents of this document is not permitted without the written permission of PORT CITY ARCHITECTURE PA



TAYLOR ENGINEERING ASSOCIATES  
410 SUMNER STREET, AUBURN, MAINE 04210 (207) 784-5471

College of Health Professions  
Building Renovation  
University of New England, Westbrook College Campus

JOB 99506

ISSUE DATE	
PRELIM.	11-7-00
APRVL.	
BID.	
C.D.'S	
REVISION 1	
PRINT	

GRADING & DRAINAGE PLAN  
SK-C-4

L:\PROJECTS\2000031\2000031details.dwg Tue Nov 07 12:59:49 2000 COPYRIGHT 2000 TAYLOR ENGINEERING ASSOCIATES

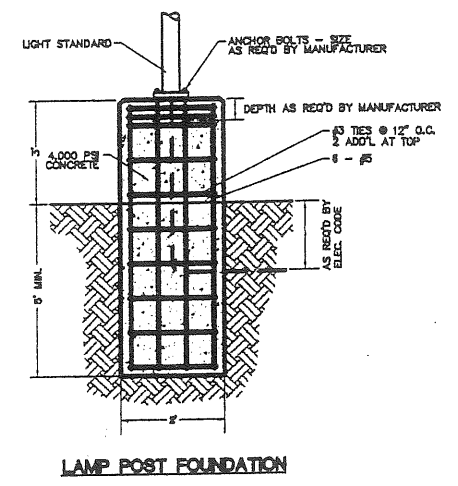
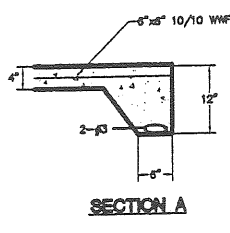
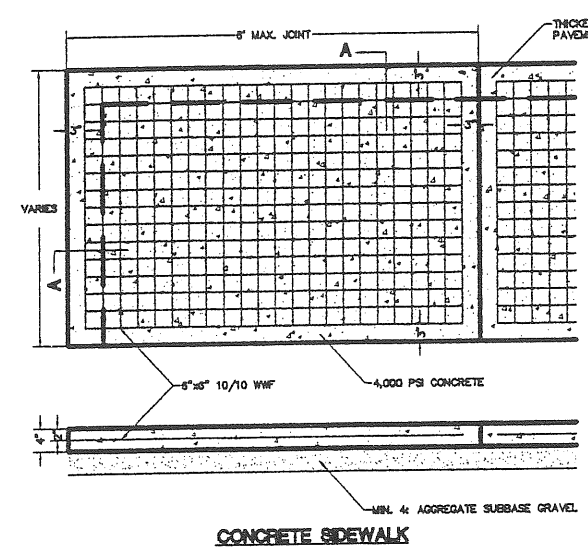

CONSTRUCT BERM DITCH AS SHOWN ON THE PLANS OR AS DIRECTED BY THE ENGINEER. WHERE A 2:1 SLOPE IS NOT PRACTICAL, USE A 1 1/2:1 SLOPE.

FOR ALL SECTIONS, DEPTH OF DITCH DEPENDS ON LOCAL CONDITIONS.

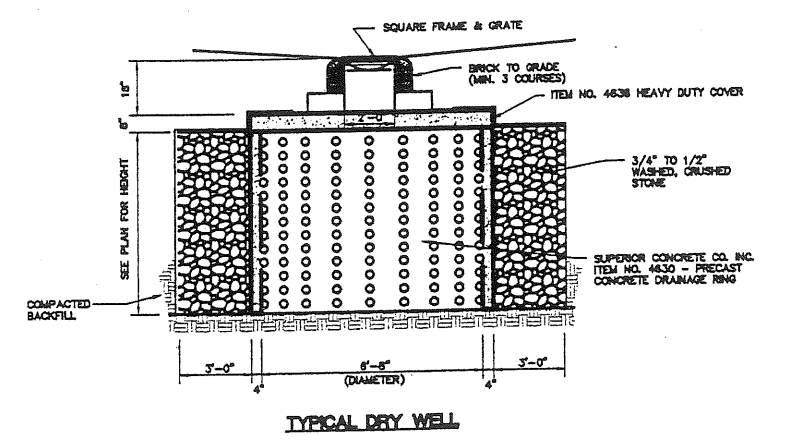
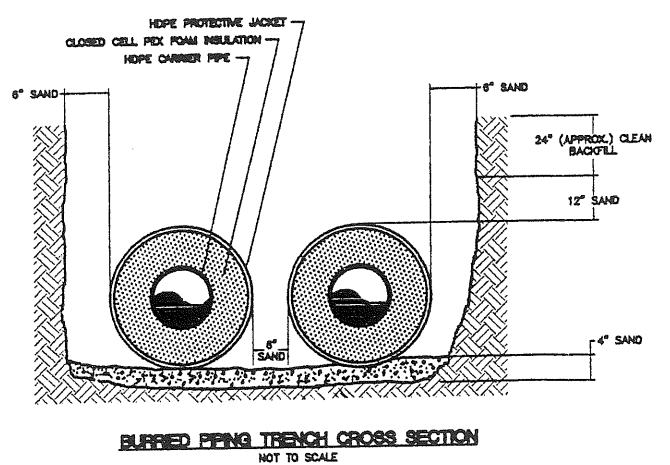
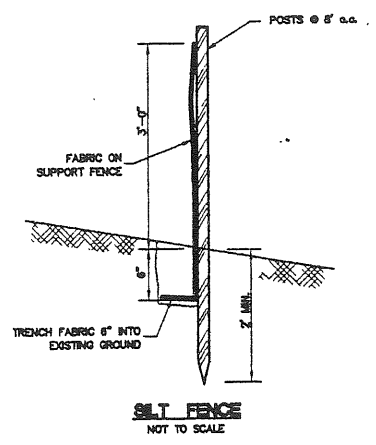
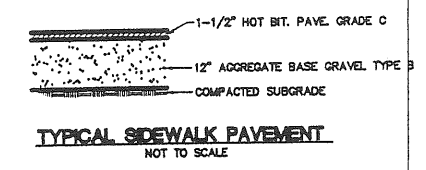
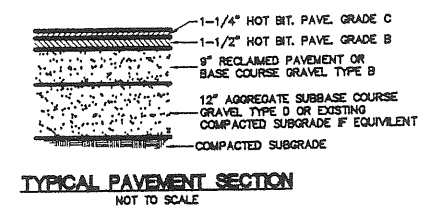
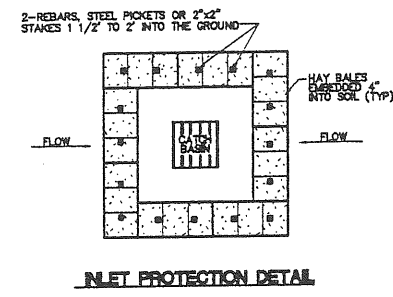
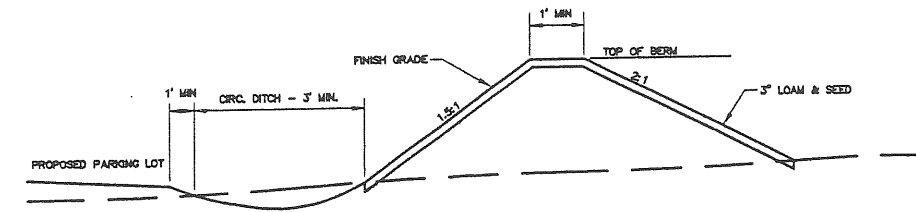

**PORT CITY ARCHITECTURE**  
65 NEWBURY STREET  
PORTLAND, ME 04101  
207.761.9000  
fax: 761.2010  
info@portcityarch.com

**© COPYRIGHT**  
Reuse or reproduction of the contents of this document is not permitted without written permission of PORT CITY ARCHITECTURE PA

**TAYLOR ENGINEERING ASSOCIATES**  
410 SUMNER STREET, AUBURN, MAINE 04210 (207) 784-5471

**College of Health Professions  
Building Renovations**  
University of New England, Westbrook College Campus

JOB 995006

ISSUE DATE	
PRELIM	11-7-00
APRVL	
BID	
C.D.'S	
REVISION 1	
PRINT	

DETAILS  
**SK-C-5**