

IF THIS SHEET IS NOT 24 X 36 IT IS A REDUCED SCALE PRINT - SCALE ACCORDINGLY

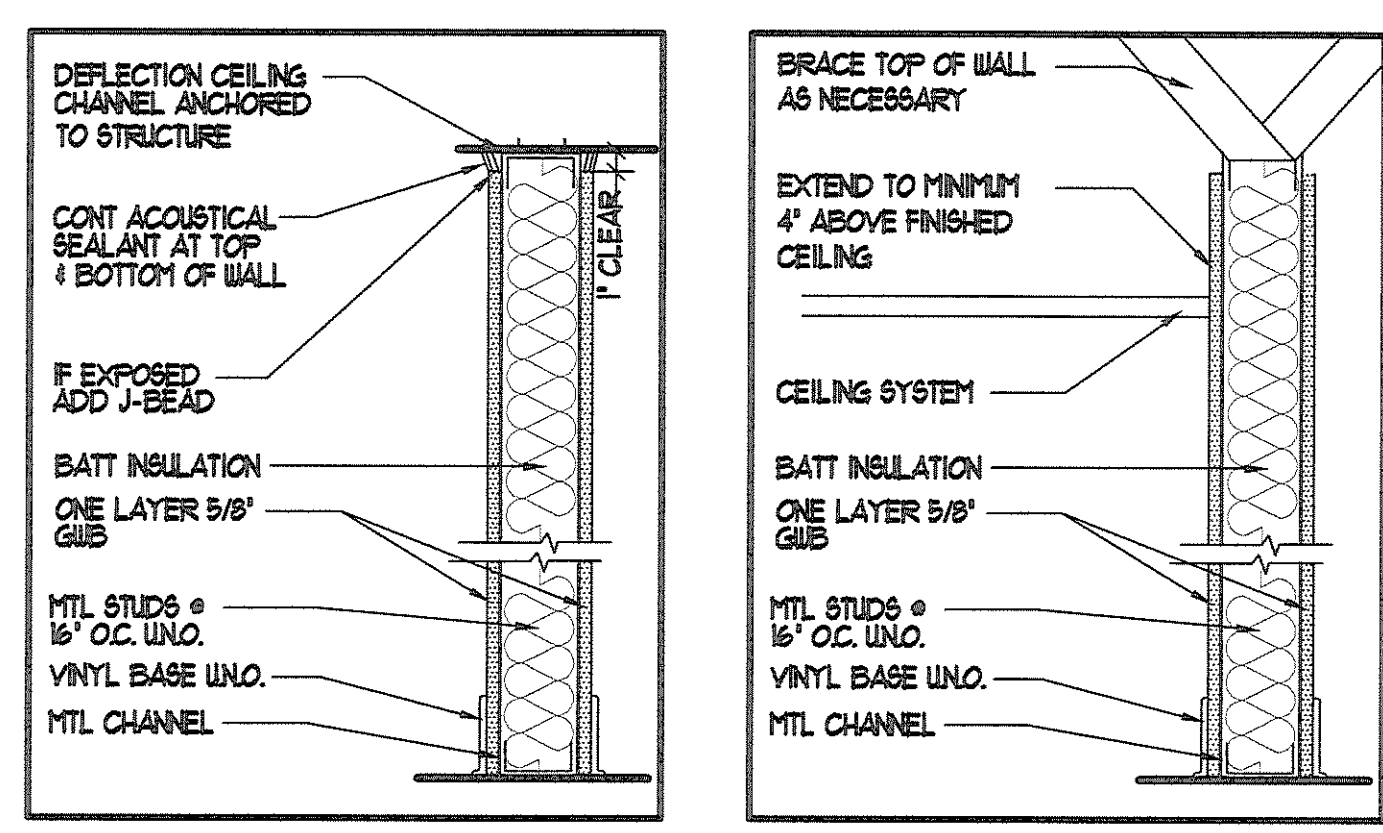

- 3 5/8" METAL STUD FULL HGT ACOUSTICAL WALL AA
- 6" METAL STUD FULL HGT ACOUSTICAL WALL AB
- (2) 3 5/8" METAL STUDS - FULL HGT ACOUSTICAL WALL (SEE PLAN FOR THICK) AC
- 2x4 STUD FULL HGT ACOUSTICAL WALL AD
- 2x8 STUD FULL HGT ACOUSTICAL WALL AE
- 3 5/8" METAL STUD PARTITION WALL EA
- 6" METAL STUD PARTITION WALL EB

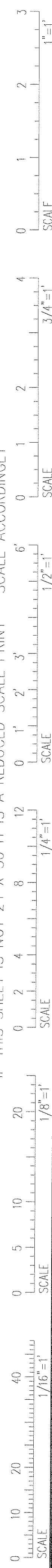
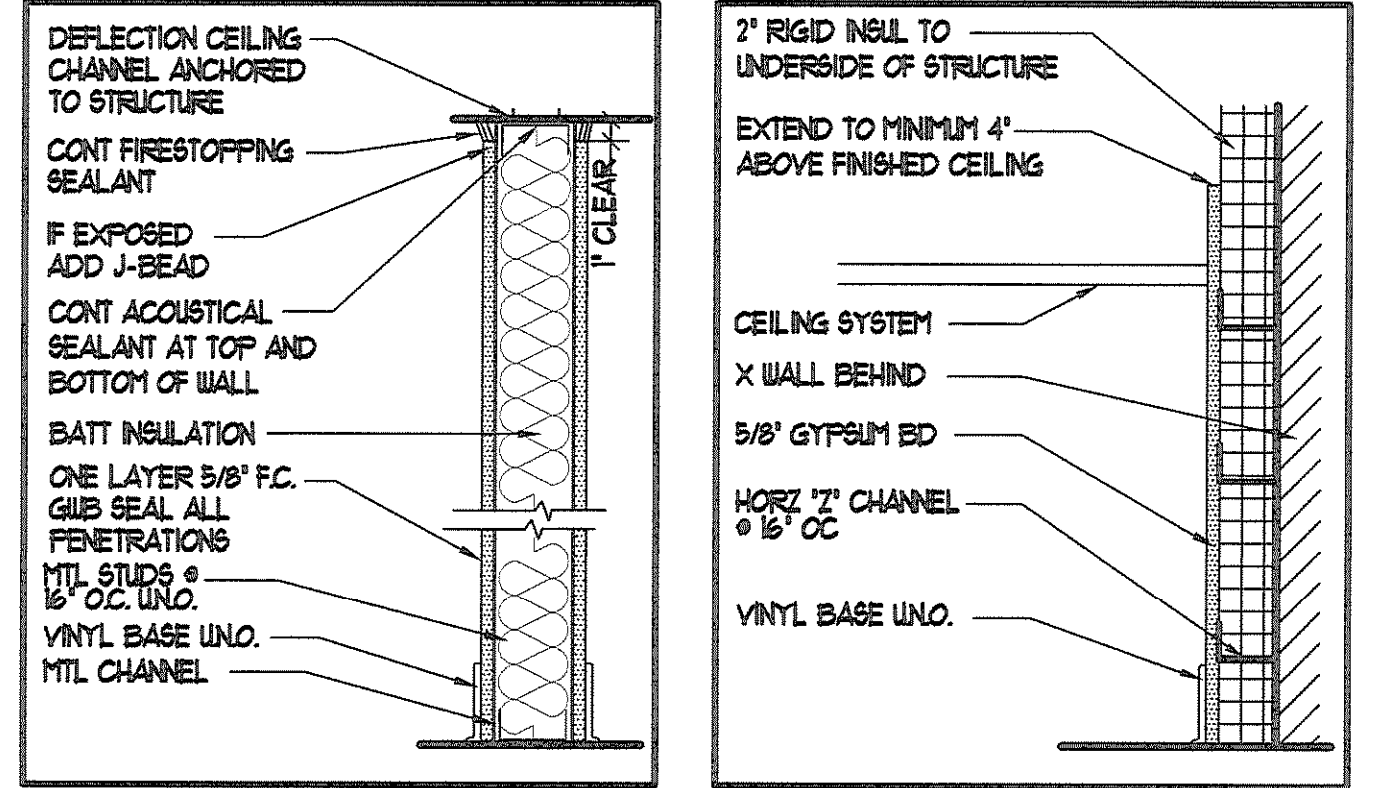

- 3 5/8" METAL STUD - FULL HGT 1 HOUR RATED UL 1455 WALL ASSEMBLY IA
- 2" RIGID INSUL TO UNDERSIDE OF STRUCTURE EXTEND TO MINIMUM 4" ABOVE FINISHED CEILING MA
- 2" RIGID INSUL TO UNDERSIDE OF STRUCTURE EXTEND TO MINIMUM 4" ABOVE FINISHED CEILING MB
- 3 3/8" MTL STUD W/ 2" INSUL GLUED HORIZONTALLY TO CONC BEHIND 3/8" GIB TO 4" ABOVE FIN. CEILING MC
- 3 3/8" MTL STUD W/ 2" INSUL GLUED HORIZONTALLY TO CONC BEHIND 3/8" GIB TO STRUCT. ABOVE MD
- 3 3/8" MTL STUD W/ AIR SPACE (SEE PLAN FOR THICK) 2" RIGID INSUL 3/8" GIB TO 4" ABOVE FIN. CEILING ME
- 3 3/8" MTL STUD W/ AIR SPACE (SEE PLAN FOR THICK) 2" RIGID INSUL 3/8" GIB TO STRUCT. ABOVE MF
- 2x4 WD STUD W/ 2" INSUL GLUED HORIZONTALLY TO CONC BEHIND 3/8" GIB TO STRUCT. ABOVE MG
- 2x4 WD STUD W/ 1/2" PLYWOOD BEHIND GIB MH

- FURRED WALL W/ 1/2" MTL HAT CHANNEL NA
- FURRED WALL W/ 3 5/8" MTL STUD - SEE PLAN FOR THICKNESS NB
- FURRED WALL W/ 3 5/8" MTL STUD TO UNDERSIDE OF STRUCT. ABOVE NC

GENERAL WALL TYPE NOTES:

- IN RESEARCH LABS, NMR AND VIVARIUM HOLD GIBS MINIMUM 1/2" FROM FINISH FLOOR
- AT ALL WET AREAS NOT ALREADY INDICATED AS WATER RESISTANT, WATER RESISTANT GIBS NEEDS TO BE PROVIDED

MECHANICAL SPACE PLAN

SCALE: 1/8" = 1'-0"

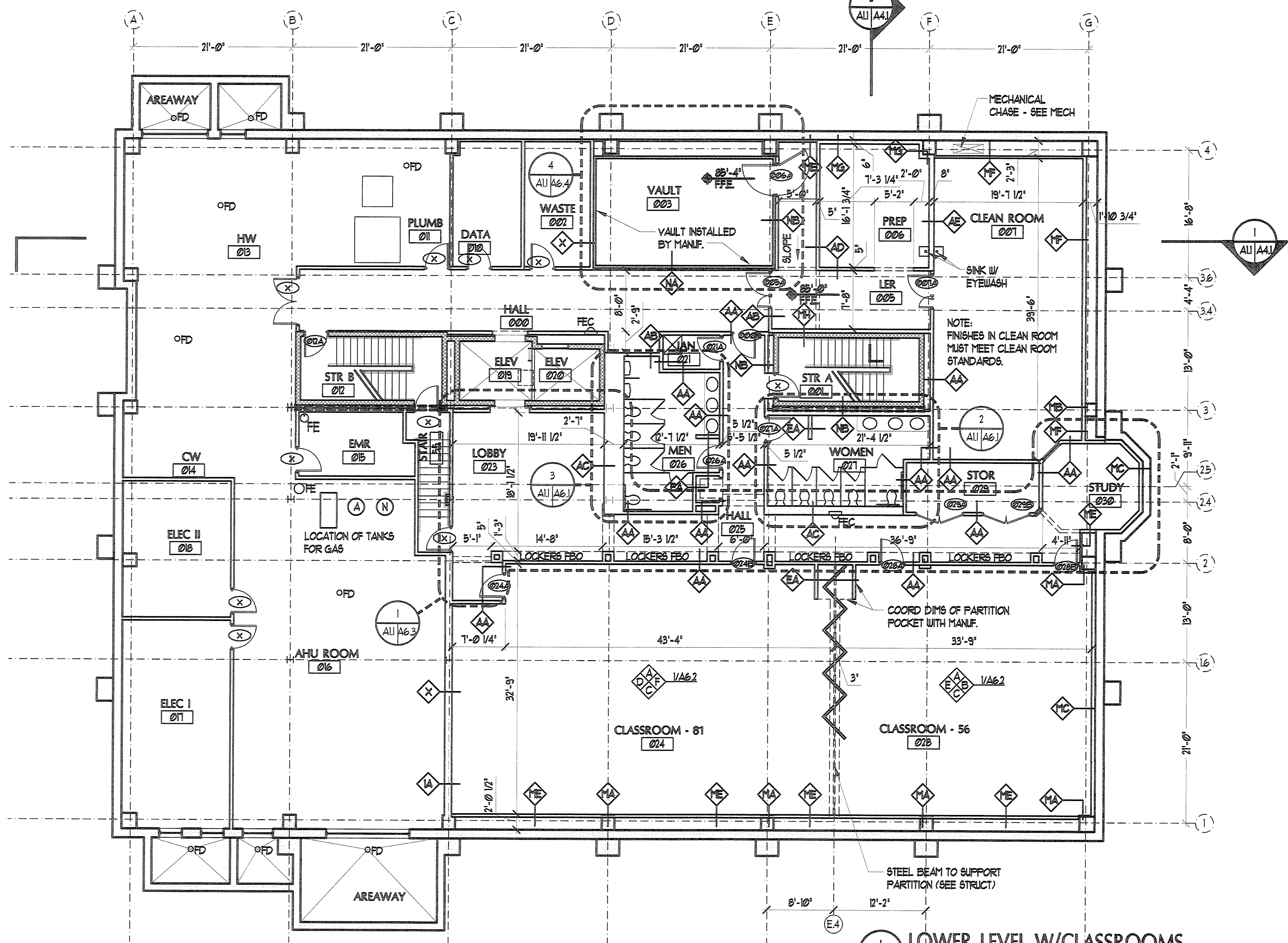
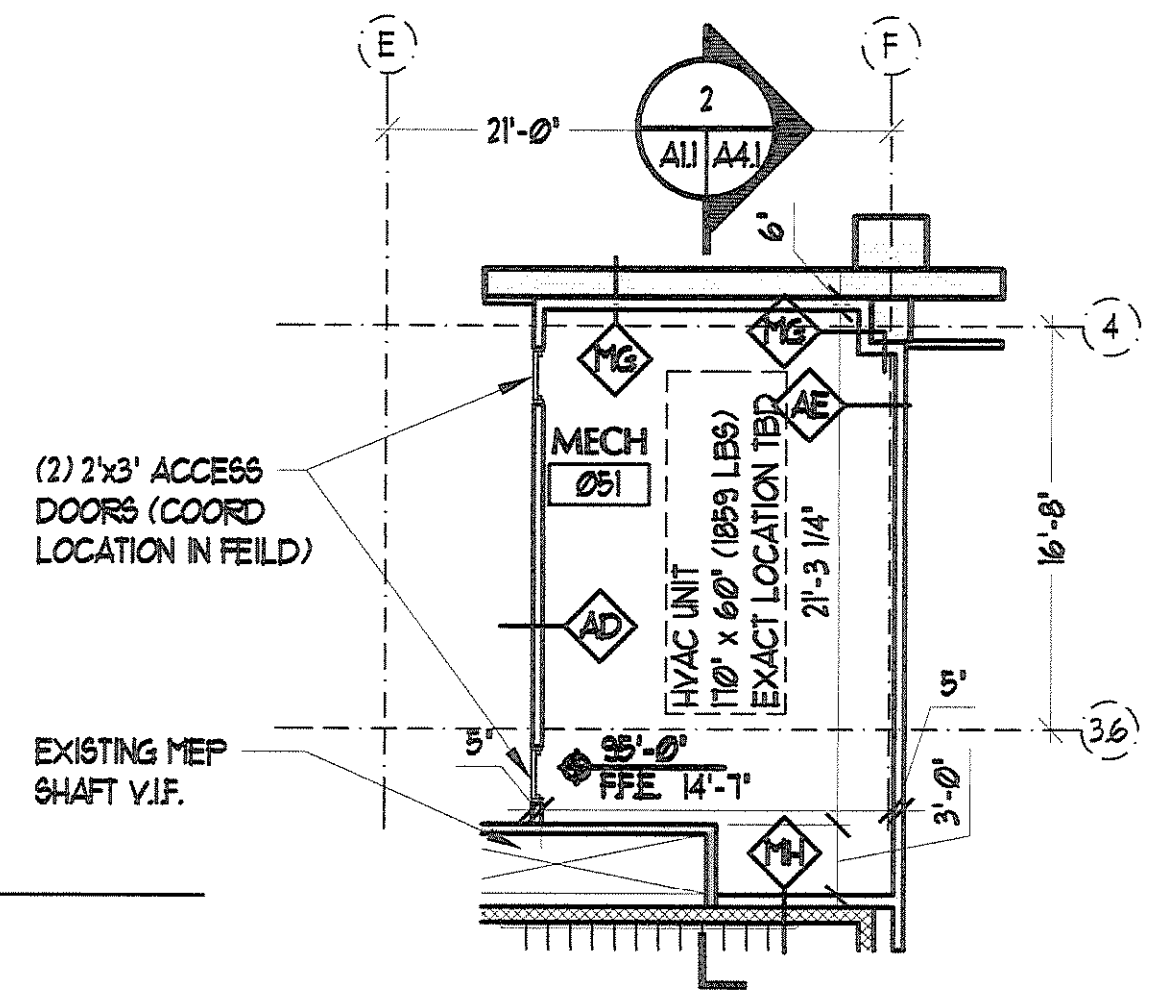

LOWER LEVEL W/CLASSROOMS

SCALE: 1/8" = 1'-0"

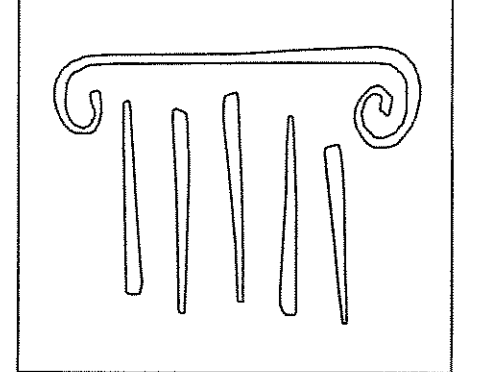

PORT CITY ARCHITECTURE

65 NEWBURY STREET
 PORTLAND, ME 04101
 207.761.9000
 fax: 207.761.2010
 lita@portcityarch.com

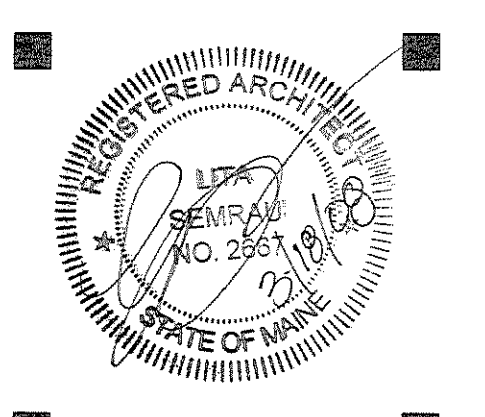

PERMIT SET NOT FOR CONSTRUCTION

**UNIVERSITY OF NEW ENGLAND
 COLLEGE OF PHARMACY
 CLASSROOMS**

75 STEVENS AVENUE, PORTLAND, ME

DATE	DESCRIPTION
3/1/2009	Date Issued
00518	Project Number

SHEET NAME
PLAN

Drawn By
 EAC
 Checked By
 LAS

**LL
 A1.1**

PERMIT SET - NOT FOR CONSTRUCTION