

CITY OF PORTLAND

BUILDING INSPECTION

PERMIT

Permit Number: 061317

Read
ation And
s, If Any,
ttached

is to certify that ALPINE REALTY CORP / Truckel Design and Fabrication

is permission to install hood system for "Izzy Cheese Co."

AT 135 WALTON ST

142 I001001

provided that the person or persons, firm or corporation accepting this permit shall comply with all of the provisions of the Statutes of Maine and of the Ordinances of the City of Portland regulating the construction, maintenance and use of buildings and structures, and of the Application on Line in this department.

PERMIT ISSUED
SEP 19 2006
CITY OF PORTLAND

Apply to Public Works for street line and grade if nature of work requires such information.

Notification of inspection must be given and written permission procured before this building or part thereof is entered or otherwise closed-in. 24 HOUR NOTICE IS REQUIRED.

A certificate of occupancy must be procured by owner before this building or part thereof is occupied.

OTHER REQUIRED APPROVALS

Fire Dept. Greg Cass PFJ

Health Dept. _____

Appeal Board _____

Other _____
Department Name

Michelle Collins 09/19/06
Director - Building & Inspection Services

PENALTY FOR REMOVING THIS CARD

City of Portland, Maine - Building or Use Permit Application

389 Congress Street, 04101 Tel: (207) 874-8703, Fax: (207) 874-8716

Permit No: 06-1317	Issue Date:	CBL: 142 I001001
-----------------------	-------------	---------------------

Location of Construction: 135 WALTON ST	Owner Name: ALPINE REALTY CORP	Owner Address: 120 EXCHANGE ST	Phone:
Business Name: Izzys Cheese Cake	Contractor Name: Henckel Design and Fabrication	Contractor Address: 134 Hartley Street Portland	Phone: 2073182623
Lessee/Buyer's Name	Phone:	Permit Type: Hood Systems, Commerical	Zone: IM

Past Use: Commercial - light manufacturing	Proposed Use: Commercial/ install hood system for "Izzy's Cheese Cake"	Permit Fee:	Cost of Work: \$3,321.00	CEO District: 4
		FIRE DEPT: <input checked="" type="checkbox"/> Approved <input type="checkbox"/> Denied NFPA 96	INSPECTION: Use Group: F1 Type: 3B Type II Hood IMC 2003	

Proposed Project Description: install hood system for "Izzy's Cheese Cake" 6" span - B" on floorplan.	Signature: <i>[Signature]</i>	Signature: <i>[Signature]</i> 09/19/06
PEDESTRIAN ACTIVITIES DISTRICT (P.A.D.)		
Action: <input type="checkbox"/> Approved <input type="checkbox"/> Approved w/Conditions <input type="checkbox"/> Denied		
Signature:		Date:

Permit Taken By: Idobson	Date Applied For: 09/08/2006	Zoning Approval
-----------------------------	---------------------------------	------------------------

- This permit application does not preclude the Applicant(s) from meeting applicable State and Federal Rules.
- Building permits do not include plumbing, septic or electrical work.
- Building permits are void if work is not started within six (6) months of the date of issuance. False information may invalidate a building permit and stop all work..

Special Zone or Reviews	Zoning Appeal	Historic Preservation
<input type="checkbox"/> Shoreland	<input type="checkbox"/> Variance	<input checked="" type="checkbox"/> Not in District or Landmark
<input type="checkbox"/> Wetland	<input type="checkbox"/> Miscellaneous	<input type="checkbox"/> Does Not Require Review
<input type="checkbox"/> Flood Zone	<input type="checkbox"/> Conditional Use	<input type="checkbox"/> Requires Review
<input type="checkbox"/> Subdivision	<input type="checkbox"/> Interpretation	<input type="checkbox"/> Approved
<input type="checkbox"/> Site Plan	<input type="checkbox"/> Approved	<input type="checkbox"/> Approved w/Conditions
Maj <input type="checkbox"/> Minor <input type="checkbox"/> MM <input type="checkbox"/>	<input type="checkbox"/> Denied	<input type="checkbox"/> Denied
Date: 9/18/06 <i>[Signature]</i>	Date:	Date: <i>[Signature]</i>

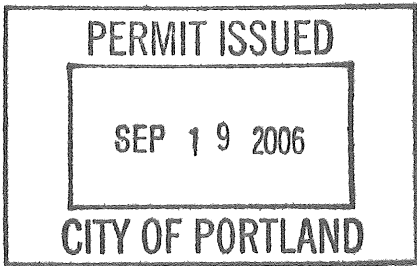

CERTIFICATION

I hereby certify that I am the owner of record of the named property, or that the proposed work is authorized by the owner of record and that I have been authorized by the owner to make this application as his authorized agent and I agree to conform to all applicable laws of this jurisdiction. In addition, if a permit for work described in the application is issued, I certify that the code official's authorized representative shall have the authority to enter all areas covered by such permit at any reasonable hour to enforce the provision of the code(s) applicable to such permit.

SIGNATURE OF APPLICANT	ADDRESS	DATE	PHONE
RESPONSIBLE PERSON IN CHARGE OF WORK, TITLE		DATE	PHONE

10/19/66

- DUT WORK FROM HOOD TO

~~MS~~

EXHAUST PAN AND WELDED JOINT

- WROTE TO AB-INSPECT

- LEFT MESSAGE WITH PETER HENCKEL

10/19/66 @ 10:00 AM

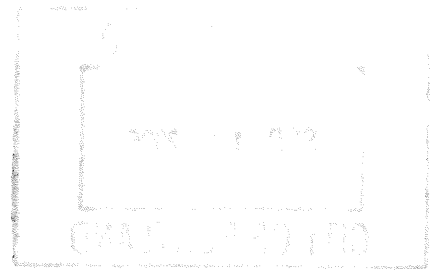

City of Portland, Maine - Building or Use Permit Application

9 Congress Street, 04101 Tel: (207) 874-8703, Fax: (207) 874-8716

Permit No: 06-1317	Issue Date:	CBL: 142 I001001
-----------------------	-------------	---------------------

Location of Construction: 135 WALTON ST	Owner Name: ALPINE REALTY CORP	Owner Address: 120 EXCHANGE ST	Phone:
Business Name: Izzys Cheese Cake	Contractor Name: Henckel Design and Fabrication	Contractor Address: 134 Hartley Street Portland	Phone: 2073182623
Lessee/Buyer's Name	Phone:	Permit Type: Hood Systems, Commerical	Zone: IM

Past Use: Commercial - light manufacturing	Proposed Use: Commercial/ install hood system for "Izzy's Cheese Cake"	Permit Fee:	Cost of Work: \$3,321.00	CEO District: 4
		FIRE DEPT: <input checked="" type="checkbox"/> Approved <input type="checkbox"/> Denied NFPA 96	INSPECTION: Use Group: F1 Type: 3B TYPE II HOOD IMC 2003	

Proposed Project Description:
install hood system for "Izzy's Cheese Cake" & "space-B" on floorplan.

Signature: *[Handwritten Signature]* Date: 09/19/06

PEDESTRIAN ACTIVITIES DISTRICT (P.A.D.)
Action: Approved Approved w/Conditions Denied
Signature: _____ Date: _____

Permit Taken By: Idobson	Date Applied For: 09/08/2006	Zoning Approval
-----------------------------	---------------------------------	------------------------

- This permit application does not preclude the Applicant(s) from meeting applicable State and Federal Rules.
- Building permits do not include plumbing, septic or electrical work.
- Building permits are void if work is not started within six (6) months of the date of issuance. False information may invalidate a building permit and stop all work..

Special Zone or Reviews	Zoning Appeal	Historic Preservation
<input type="checkbox"/> Shoreland	<input type="checkbox"/> Variance	<input checked="" type="checkbox"/> Not in District or Landmark
<input type="checkbox"/> Wetland	<input type="checkbox"/> Miscellaneous	<input type="checkbox"/> Does Not Require Review
<input type="checkbox"/> Flood Zone	<input type="checkbox"/> Conditional Use	<input type="checkbox"/> Requires Review
<input type="checkbox"/> Subdivision	<input type="checkbox"/> Interpretation	<input type="checkbox"/> Approved
<input type="checkbox"/> Site Plan	<input type="checkbox"/> Approved	<input type="checkbox"/> Approved w/Conditions
Maj <input type="checkbox"/> Minor <input type="checkbox"/> MM <input type="checkbox"/>	<input type="checkbox"/> Denied	<input type="checkbox"/> Denied
Date: 9/8/06 <i>[Handwritten Signature]</i>	Date: _____	Date: _____

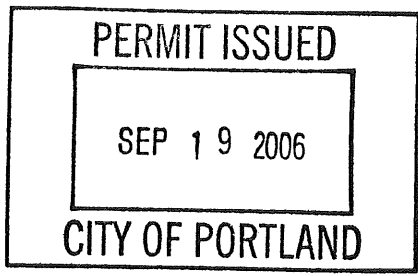

CERTIFICATION

I hereby certify that I am the owner of record of the named property, or that the proposed work is authorized by the owner of record and that I have been authorized by the owner to make this application as his authorized agent and I agree to conform to all applicable laws of this jurisdiction. In addition, if a permit for work described in the application is issued, I certify that the code official's authorized representative shall have the authority to enter all areas covered by such permit at any reasonable hour to enforce the provision of the code(s) applicable to such permit.

SIGNATURE OF APPLICANT	ADDRESS	DATE	PHONE
RESPONSIBLE PERSON IN CHARGE OF WORK, TITLE		DATE	PHONE

Please call 874-8703 or 874-8693 to schedule your inspections as agreed upon

Permits expire in 6 months, if the project is not started or ceases for 6 months.

The Owner or their designee is required to notify the inspections office for the following inspections and provide adequate notice. Notice must be called in 48-72 hours in advance in order to schedule an inspection:

By initializing at each inspection time, you are agreeing that you understand the inspection procedure and additional fees from a "Stop Work Order" and "Stop Work Order Release" will be incurred if the procedure is not followed as stated below.

A Pre-construction Meeting will take place upon receipt of your building permit.

- Footing/Building Location Inspection: Prior to pouring concrete
- Re-Bar Schedule Inspection: Prior to pouring concrete
- Foundation Inspection: Prior to placing ANY backfill
- Framing/Rough Plumbing/Electrical: Prior to any insulating or drywalling
- Final/Certificate of Occupancy: Prior to any occupancy of the structure or use. NOTE: There is a \$75.00 fee per inspection at this point.

Certificate of Occupancy is not required for certain projects. Your inspector can advise you if your project requires a Certificate of Occupancy. All projects DO require a final

^{inspection} If any of the inspections do not occur, the project cannot go on to the next phase, REGARDLESS OF THE NOTICE OR CIRCUMSTANCES.

CERTIFICATE OF OCCUPANCIES MUST BE ISSUED AND PAID FOR, BEFORE THE SPACE MAY BE OCCUPIED

B Hill
Signature of Applicant/Designee
Donna Martin Admin
Signature of Inspections Official

Date
9-19-06

Date

CBL: 142 1001 Building Permit #: 061317



Phone: 1-207-318-2623

Fax: 1-207-772-8952

E-mail: petehenckel@maine.rr.com

September 5, 2006

Site Location
#135 Walton St
Portland Me 04103

Izzys Cheese Cake

The hanging surface at the bakery is schedule 8/15 steel beam or larger with a ceiling elevation Of 12' at the bottom of the structural steel with a standard elevation of 15' to the wooden roof the beam clamps will be set at the upper beams for code requirement.

The hood will be hung using 3/8" threaded rod at six points on the hood the rod will be attached to the joist using 3/8" beam clamps.

(the hood weight is 393LBS)(3/8" rods 1200LBS per rod capacity)

the duct work will be 16ga welded black iron and will terminate at a point that is 10' away from from any window opening and any intake system as well as any other HVAC unit at the point of termination.

(the curb and fan are to be located on the roof)

At the point where the duct work comes with in the minimum standoff requirements a fire shield Insulation will be installed per code requirements.

The wall where the hood will be located is cinder block construction so no standoff wall and or Stainless steel will be required.

All work to be performed will be NFPA compliant.



Henckel Design and Fabrication

134 Hartley Street
Portland, Maine
04103

Phone: 1-207-318-2623
Fax: 1-207-772-8952
E-mail: petehenckel@maine.rr.com

August 22, 2006

Gary,

Here is the quote for the new Izzys Cheese Cake if you have any question after you read this please feel free to call.

This quote includes no electrical work all item provided by H/D/F will carry a one year warranty.

- #1. Provide and install one twelve foot by sixteen foot exhaust hood.
- #2. Install one roof curb for the installation of the new exhaust duct and fan.
- #3. Install the new exhaust duct and attach it to exhaust hood.
- #4. Once the duct is installed in the curb the new exhaust fan will be installed.
- #5. A fire barrier will be installed where every the proximity to a consumable is out of code.

Total quote for the work listed above \$3321.00

- Restaurant Hoods • Boiler Breaching • HVAC Design • Curb Adapters and Unit Installations •
 - Welded Ducting • Custom Welding Fabrication •



General Building Permit Application

If you or the property owner owes real estate or personal property taxes or user charges on any property within the City, payment arrangements must be made before permits of any kind are accepted.

Location/Address of Construction: <u>135 Walton St Portland Me</u>		
Total Square Footage of Proposed Structure		Square Footage of Lot
Tax Assessor's Chart, Block & Lot Chart# Block# Lot# <u>142 I 1</u>	Owner:	Telephone:
Lessee/Buyer's Name (If Applicable)	Applicant name, address & telephone: <u>Mencle Design</u> <u>134 Hartley St.</u> <u>Portland, ME 04103</u> <u>318 2623</u>	Cost Of Work: \$ _____ Fee: \$ <u>60</u> C of O Fee: \$ _____
Current Specific use: _____ If vacant, what was the previous use? _____ Proposed Specific use: _____		
Project description: <u>Hood System for "FZZYS Cheese Cate"</u>		
Contractor's name, address & telephone:		
Who should we contact when the permit is ready: <u>Peter Hanzikel</u> Mailing address: _____ Phone: <u>207-318-2623</u>		

Please submit all of the information outlined in the Commercial Application Checklist. Failure to do so will result in the automatic denial of your permit.

In order to be sure the City fully understands the full scope of the project, the Planning and Development Department may request additional information prior to the issuance of a permit. For further information visit us on-line at www.portlandmaine.gov, stop by the Building Inspections office, room 315 City Hall or call 874-8703.

I hereby certify that I am the Owner of record of the named property, or that the owner of record authorizes the proposed work and that I have been authorized by the owner to make this application as his/her authorized agent. I agree to conform to all applicable laws of this jurisdiction. In addition, if a permit for work described in this application is issued, I certify that the Code Official's authorized representative shall have the authority to enter all areas covered by this permit at any reasonable hour to enforce the provisions of the codes applicable to this permit.

Signature of applicant: <u>[Signature]</u>	Date: <u>09-08-06</u>
--	-----------------------

This is not a permit; you may not commence ANY work until the permit is issued.

SQUARE FOOTAGES
 AREA A: 1369 SQ. FT.
 AREA B: 2,958 SQ. FT.
 AREA C: 4,420 SQ. FT.
 AREA D: 1,422 SQ. FT.
 AREA E: 6,933 SQ. FT.
 AREA F: 4,942 SQ. FT.
 AREA G: 10,664 SQ. FT.
 AREA H: 20,287 SQ. FT.

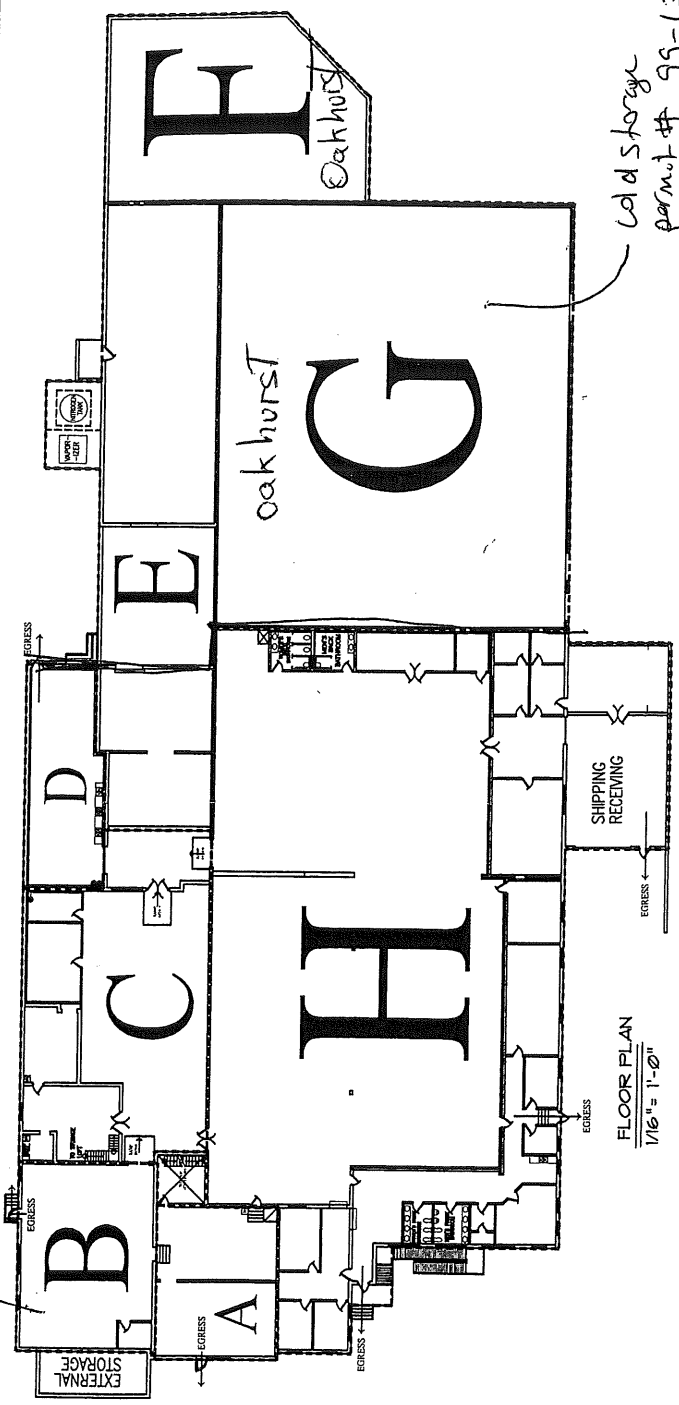

*Cold Storage
 permit # 99-1326*

oakhurst

Oakhurst

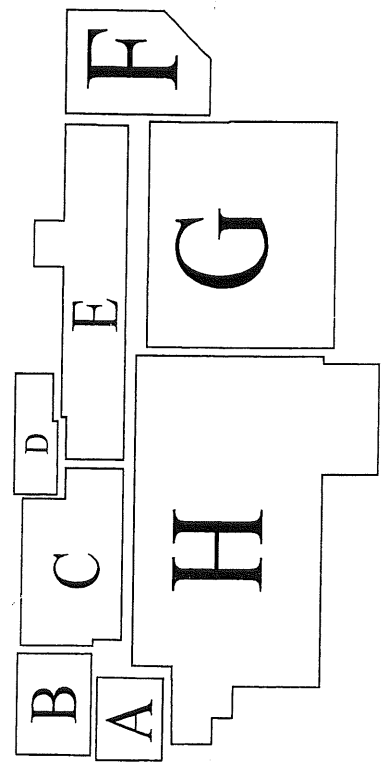

KEYPLAN
 NO SCALE

FLOOR PLAN
 1/16" = 1'-0"

*(22) 5
 Access
 9/17/04*



PORTLAND MAINE

Strengthening a Remarkable City, Building a Community for Life • www.portlandmaine.gov

Lee Urban- Director of Planning and Development
Michael J. Nugent- Inspections Division Director

Kitchen Exhaust System Checklist and Code Provisions

Dear Applicant,

The following is a checklist to assist you in filing for a permit for a Kitchen Exhaust system. The applicable Mechanical Code provisions have also been attached. Please complete this and submit job specific construction documents that demonstrate compliance with the attached information.

Type of System:

Type I _____ Type II ✓

(Type I systems are systems that vent fryers, grills, broilers, ovens or woks. Type II systems are systems that vent steamers and other non grease producing appliances)

Type of Materials:

Is the hood Stainless steel or other type of steel? 16 Ga. Galvalume If Other, what Type? _____

Is the duct work Stainless steel or other type of steel? Black Iron If Other, what type? 16 Gauge

Thickness of the steel for the hood 16 Ga

Thickness of the duct for the hood 16 Ga

Type of Hood and Duct supports

The duct is a vertical rise

Type of seams and Joints All welded

Type II

Grease Gutters provided? NO

Hood Clearance from Combustibles materials MIN 18"

Duct Clearance from Combustibles materials Per Code

Vibration Isolation System:
YES

Air Velocity within the duct system MIN 1500 FPM

Grease accumulation prevention system
NO

Cleanouts NO

Grease Duct enclosure NO

Exhaust Termination Roof Code 506.3.3

Fire Suppression system NO

Exhaust fan mounting and clearance from the roof or wall (Roof) 40"
above the Roof

Exhaust fan distance from other vents or openings MIN 10'

Exhaust fan height above adjoining grade Roof Mount

Hood Specs

Style of hood Type II

Type of Filter: Aluminum baffle

Height of filter above nearest cooking surface: _____

Capacity of hood in CFM 2279 CFM

Make up Air system description and capacity
Re-use existing Fans

Grease Gutters provided? NO (Type II Hood)

Hood Clearance from Combustibles materials 18" MIN

Duct Clearance from Combustibles materials MIN 18" or ZERO clearance
INSULATION shall be used

Vibration Isolation System: YES

Air Velocity within the duct system 1900 FPM @ ϕ sp 2366 CFM

Grease accumulation prevention system Type II Hood.

Cleanouts NO

Grease Duct enclosure _____

Exhaust Termination EXHAUST TERMS @ THE ROOF

Fire Suppression system NONE

Exhaust fan mounting and clearance from the roof or wall CURB will be 14" TALL
WITH A FAN CLEARANCE OF 40" MIN FROM THE ROOF

Exhaust fan distance from other vents or openings 10' MINIMUM

Exhaust fan height above adjoining grade ROOF MOUNT (FLAT ROOF)

Hood Specs

Style of hood Type two

Type of Filter: ALUMINUM Baffle

Height of filter above nearest cooking surface: MIN 33" Max 48"

Capacity of hood in CFM _____

Make up Air system description and capacity

AN 36" SQUARE FAN THAT IS ALREADY IN PLACE WILL BE
USED AND A LOUVER WILL BE ADDED, AND OR A
EXTERNAL HOOD

SECTION 506 COMMERCIAL KITCHEN HOOD VENTILATION SYSTEM DUCTS AND EXHAUST EQUIPMENT

506.1 General. Commercial kitchen hood ventilation ducts and exhaust equipment shall comply with the requirements of this section. Commercial kitchen grease ducts shall be designed for the type of cooking appliance and hood served.

506.2 Corrosion protection. Ducts exposed to the outside atmosphere or subject to a corrosive environment shall be protected against corrosion in an approved manner.

506.3 Ducts serving Type I hoods. Type I exhaust ducts shall be independent of all other exhaust systems except as provided in Section 506.3.5. Commercial kitchen duct systems serving Type I hoods shall be designed, constructed and installed in accordance with Sections 506.3.1 through 506.3.12.3.

506.3.1 Duct materials. Ducts serving Type I hoods shall be constructed of materials in accordance with Sections 506.3.1.1 and 506.3.1.2.

506.3.1.1 Grease duct materials. Grease ducts serving Type I hoods shall be constructed of steel not less than 0.055 inch (1.4 mm) (No. 16 Gage) in thickness or stainless steel not less than 0.044 inch (1.1 mm) (No. 18 Gage) in thickness.

Exception: Listed and labeled factory-built commercial kitchen grease ducts shall be installed in accordance with Section 304.1.

506.3.1.2 Makeup air ducts. Makeup air ducts connecting to or within 18 inches (457 mm) of a Type I hood shall be constructed and installed in accordance with Sections 603.1, 603.3, 603.4, 603.9, 603.10 and 603.12. Duct insulation installed within 18 inches (457 mm) of a Type I hood shall be noncombustible or shall be listed for the application.

506.3.2 Joints, seams and penetrations of grease ducts. Joints, seams and penetrations of grease ducts shall be made with a continuous liquid-tight weld or braze made on the external surface of the duct system.

Exceptions:

1. Penetrations shall not be required to be welded or brazed where sealed by devices that are listed for the application.
2. Internal welding or brazing shall not be prohibited provided that the joint is formed or ground smooth and is provided with ready access for inspection.
3. Listed and labeled factory-built commercial kitchen grease ducts installed in accordance with Section 304.1.

506.3.2.1 Duct joint types. Duct joints shall be butt joints or overlapping duct joints of either the telescoping or bell type. Overlapping joints shall be installed to prevent ledges and obstructions from collecting grease or interfering with gravity drainage to the intended collection point. The difference between the inside cross-sectional dimensions of overlapping sections of duct shall not exceed 0.25 inch (6 mm). The length of overlap for overlapping duct joints shall not exceed 2 inches (51 mm).

506.3.2.2 Duct-to-hood joints. Duct-to-hood joints shall be made with continuous internal or external liquid-tight welded or brazed joints. Such joints shall be smooth, accessible for inspection, and without grease traps.

Exceptions: This section shall not apply to:

1. A vertical duct-to-hood collar connection made in the top plane of the hood in accordance with all of the following:
 - 1.1. The hood duct opening shall have a 1-inch-deep (25 mm), full perimeter, welded flange turned down into the hood interior at an angle of 90 degrees from the plane of the opening.
 - 1.2. The duct shall have a 1-inch-deep (25 mm) flange made by a 1-inch by 1-inch (25 mm by 25 mm) angle iron welded to the full perimeter of the duct not less than 1 inch (25 mm) above the bottom end of the duct.
 - 1.3. A gasket rated for use at not less than 1,500°F (815°C) is installed between the duct flange and the top of the hood.
 - 1.4. The duct-to-hood joint shall be secured by stud bolts not less than 0.25 inch (6.4 mm) in diameter welded to the hood with a spacing not greater than 4 inches (102 mm) on center for the full perimeter of the opening. All bolts and nuts are to be secured with lockwashers.
2. Listed and labeled duct-to-hood collar connections installed in accordance with Section 304.1.

506.3.2.3 Duct-to-exhaust fan connections. Duct-to-exhaust fan connections shall be flanged and gasketed at the base of the fan for vertical discharge fans; shall be flanged, gasketed and bolted to the inlet of the fan for side-inlet utility fans; and shall be flanged, gasketed and bolted to the inlet and outlet of the fan for in-line fans.

506.3.2.4 Vibration isolation. A vibration isolation connector for connecting a duct to a fan shall consist of noncombustible packing in a metal sleeve joint of approved design or shall be a coated-fabric flexible duct connector listed and labeled for the application. Vibration isolation connectors shall be installed only at the connection of a duct to a fan inlet or outlet.

506.3.3 Grease duct supports. Grease duct bracing and supports shall be of noncombustible material securely attached to the structure and designed to carry gravity and seismic loads within the stress limitations of the *International Building Code*. Bolts, screws, rivets and other mechanical fasteners shall not penetrate duct walls.

506.3.4 Air velocity. Grease duct systems serving a Type I hood shall be designed and installed to provide an air velocity within the duct system of not less than 1,500 feet per minute (7.6 m/s).

Exception: The velocity limitations shall not apply within duct transitions utilized to connect ducts to differently

sized or shaped openings in hoods and fans, provided that such transitions do not exceed 3 feet (914 mm) in length and are designed to prevent the trapping of grease.

506.3.5 Separation of grease duct system. A separate grease duct system shall be provided for each Type I hood. A separate grease duct system is not required where all of the following conditions are met:

1. All interconnected hoods are located within the same story.
2. All interconnected hoods are located within the same room or in adjoining rooms.
3. Interconnecting ducts do not penetrate assemblies required to be fire-resistance rated.
4. The grease duct system does not serve solid fuel-fired appliances.

506.3.6 Grease duct clearances. Grease duct systems and exhaust equipment serving a Type I hood shall have a clearance to combustible construction of not less than 18 inches (457 mm), and shall have a clearance to noncombustible construction and gypsum wallboard attached to noncombustible structures of not less than 3 inches (76 mm).

Exception: Listed and labeled factory-built commercial kitchen grease ducts and exhaust equipment installed in accordance with Section 304.1.

506.3.7 Prevention of grease accumulation in grease ducts. Duct systems serving a Type I hood shall be constructed and installed so that grease cannot collect in any portion thereof, and the system shall slope not less than one-fourth unit vertical in 12 units horizontal (2-percent slope) toward the hood or toward an approved grease reservoir. Where horizontal ducts exceed 75 feet (22 860 mm) in length, the slope shall not be less than one unit vertical in 12 units horizontal (8.3-percent slope).

506.3.8 Grease duct cleanouts and other openings. Grease duct systems shall not have openings therein other than those required for proper operation and maintenance of the system. Any portion of such system having sections not provided with access from the duct entry or discharge shall be provided with cleanout openings. Cleanout openings shall be equipped with tight-fitting doors constructed of steel having a thickness not less than that required for the duct. Doors shall be equipped with a substantial method of latching, sufficient to hold the door tightly closed. Doors shall be designed so that they are operable without the use of a tool. Door assemblies, including any frames and gasketing, shall be approved for the purpose, and shall not have fasteners that penetrate the duct. Listed and labeled access door assemblies shall be installed in accordance with the terms of the listing.

506.3.8.1 Personnel entry. Where ductwork is large enough to allow entry of personnel, not less than one approved or listed opening having dimensions not less than 20 inches by 20 inches (508 mm by 508 mm) shall be provided in the horizontal sections, and in the top of vertical risers. Where such entry is provided, the duct and its supports shall be capable of supporting the additional load and the cleanouts specified in Section 506.3.8 are not required.

506.3.9 Grease duct horizontal cleanouts. Cleanouts located on horizontal sections of ducts shall be spaced not more than 20 feet (6096 mm) apart. The cleanouts shall be located on the side of the duct with the opening not less than 1.5 inches (38 mm) above the bottom of the duct, and not less than 1 inch (25 mm) below the top of the duct. The opening minimum dimensions shall be 12 inches (305 mm) on each side. Where the dimensions of the side of the duct prohibit the cleanout installation prescribed herein, the openings shall be on the top of the duct or the bottom of the duct. Where located on the top of the duct, the opening edges shall be a minimum of 1 inch (25 mm) from the edges of the duct. Where located in the bottom of the duct, cleanout openings shall be designed to provide internal damming around the opening, shall be provided with gasketing to preclude grease leakage, shall provide for drainage of grease down the duct around the dam, and shall be approved for the application. Where the dimensions of the sides, top or bottom of the duct preclude the installation of the prescribed minimum-size cleanout opening, the cleanout shall be located on the duct face that affords the largest opening dimension and shall be installed with the opening edges at the prescribed distances from the duct edges as previously set forth in this section.

506.3.10 Grease duct enclosure. A grease duct serving a Type I hood that penetrates a ceiling, wall or floor shall be enclosed from the point of penetration to the outlet terminal. A duct shall penetrate exterior walls only at locations where unprotected openings are permitted by the *International Building Code*. Ducts shall be enclosed in accordance with the *International Building Code* requirements for shaft construction. The duct enclosure shall be sealed around the duct at the point of penetration and vented to the outside of the building through the use of weather-protected openings. Clearance from the duct to the interior surface of enclosures of combustible construction shall be not less than 18 inches (457 mm). Clearance from the duct to the interior surface of enclosures of noncombustible construction or gypsum wallboard attached to noncombustible structures shall be not less than 6 inches (152 mm). The duct enclosure shall serve a single grease exhaust duct system and shall not contain any other ducts, piping, wiring or systems.

Exceptions:

1. The shaft enclosure provisions of this section shall not be required where a duct penetration is protected with a through-penetration firestop system classified in accordance with ASTM E 814 and having an "F" and "T" rating equal to the fire-resistance rating of the assembly being penetrated and where the surface of the duct is continuously covered on all sides from the point at which the duct penetrates a ceiling, wall or floor to the outlet terminal with a classified and labeled material, system, method of construction or product specifically evaluated for such purpose, in accordance with a nationally recognized standard for such enclosure materials. Exposed duct wrap systems shall be protected where subject to physical damage.
2. A duct enclosure shall not be required for a grease duct that penetrates only a nonfire-resistance-rated roof/ceiling assembly.

506.3.11 Grease duct fire-resistive access opening. Where cleanout openings are located in ducts within a fire-resistance-rated enclosure, access openings shall be provided in the enclosure at each cleanout point. Access openings shall be equipped with tight-fitting sliding or hinged doors that are equal in fire-resistive protection to that of the shaft or enclosure. An approved sign shall be placed on access opening panels with wording as follows: "ACCESS PANEL. DO NOT OBSTRUCT."

506.3.12 Exhaust outlets serving Type I hoods. Exhaust outlets for grease ducts serving Type I hoods shall conform to the requirements of Sections 506.3.12.1 through 506.3.12.3.

506.3.12.1 Termination above the roof. Exhaust outlets that terminate above the roof shall have the discharge opening located not less than 40 inches (1016 mm) above the roof surface.

506.3.12.2 Termination through an exterior wall. Exhaust outlets shall be permitted to terminate through exterior walls where the smoke, grease, gases, vapors, and odors in the discharge from such terminations do not create a public nuisance or a fire hazard. Such terminations shall not be located where protected openings are required by the International Building Code. Other exterior openings shall not be located within 3 feet (914 mm) of such terminations.

506.3.12.3 Termination location. Exhaust outlets shall be located not less than 10 feet (3048 mm) horizontally from parts of the same or contiguous buildings, adjacent property lines and air intake openings into any building and shall be located not less than 10 feet (3048 mm) above the adjoining grade level.

Exception: Exhaust outlets shall terminate not less than 5 feet (1524 mm) from an adjacent building, adjacent property line and air intake openings into a building where air from the exhaust outlet discharges away from such locations.

506.4 Ducts serving Type II hoods. Single or combined Type II exhaust systems for food-processing operations shall be independent of all other exhaust systems. Commercial kitchen exhaust systems serving Type II hoods shall comply with Sections 506.4.1 and 506.4.2.

506.4.1 Type II exhaust outlets. Exhaust outlets for ducts serving Type II hoods shall comply with Sections 401.5 and 401.5.2. Such outlets shall be protected against local weather conditions and shall meet the provisions for exterior wall opening protectives in accordance with the International Building Code.

506.4.2 Ducts. Ducts and plenums serving Type II hoods shall be constructed of rigid metallic materials. Duct construction, installation, bracing and supports shall comply with Chapter 6. Ducts subject to positive pressure and ducts conveying moisture-laden or waste-heat-laden air shall be constructed, joined and sealed in an approved manner.

506.5 Exhaust equipment. Exhaust equipment, including fans and grease reservoirs, shall comply with Section 506.5.1

through 506.5.5 and shall be of an approved design or shall be listed for the application.

506.5.1 Exhaust fans. Exhaust fan housings serving a Type I hood shall be constructed as required for grease ducts in accordance with Section 506.3.1.1.

Exception: Fans listed and labeled in accordance with UL 762.

506.5.1.1 Fan motor. Exhaust fan motors shall be located outside of the exhaust airstream.

506.5.2 Exhaust fan discharge. Exhaust fans shall be positioned so that the discharge will not impinge on the roof, other equipment or appliances or parts of the structure. A vertical discharge fan shall be manufactured with an approved drain outlet at the lowest point of the housing to permit drainage of grease to an approved grease reservoir.

506.5.3 Exhaust fan mounting. An upblast fan shall be hinged and supplied with a flexible weatherproof electrical cable to permit inspection and cleaning. The ductwork shall extend a minimum of 18 inches (457 mm) above the roof surface.

506.5.4 Clearances. Exhaust equipment serving a Type I hood shall have a clearance to combustible construction of not less than 18 inches (457 mm).

Exception: Factory-built exhaust equipment installed in accordance with Section 304.1 and listed for a lesser clearance.

506.5.5 Termination location. The outlet of exhaust equipment serving Type I hoods, shall be in accordance with Section 506.3.12.3

Exception: The minimum horizontal distance between vertical discharge fans and parapet-type building structures shall be 2 feet (610 mm) provided that such structures are not higher than the top of the fan discharge opening.

SECTION 507 COMMERCIAL KITCHEN HOODS

507.1 General. Commercial kitchen exhaust hoods shall comply with the requirements of this section. Hoods shall be Type I or Type II and shall be designed to capture and confine cooking vapors and residues.

Exceptions:

1. Factory-built commercial exhaust hoods which are tested in accordance with UL 710, listed, labeled and installed in accordance with Section 304.1 shall not be required to comply with Sections 507.4, 507.7, 507.11, 507.12, 507.13, 507.14 and 507.15.
2. Factory-built commercial cooking recirculating systems which are tested in accordance with UL 197, listed, labeled and installed in accordance with Section 304.1 shall not be required to comply with Sections 507.4, 507.5, 507.7, 507.12, 507.13, 507.14 and 507.15.
3. Net exhaust volumes for hoods shall be permitted to be reduced during no-load cooking conditions, where

engineered or listed multi-speed or variable-speed controls automatically operate the exhaust system to maintain capture and removal of cooking effluents as required by this section.

507.2 Where required. A Type I or Type II hood shall be installed at or above all commercial cooking appliances in accordance with Sections 507.2.1 and 507.2.2. Where any cooking appliance under a single hood requires a Type I hood, a Type I hood shall be installed. Where a Type II hood is required, a Type I or Type II hood shall be installed.

507.2.1 Type I hoods. Type I hoods shall be installed where cooking appliances produce grease or smoke, such as occurs with griddles, fryers, broilers, ovens, ranges and wok ranges.

507.2.2 Type II hoods. Type II hoods shall be installed where cooking or dishwashing appliances produce heat or steam and do not produce grease or smoke, such as steamers, kettles, pasta cookers and dishwashing machines.

Exceptions:

1. Under-counter-type commercial dishwashing machines.
2. A Type II hood is not required for dishwashers and potwashers that are provided with heat and water vapor exhaust systems that are supplied by the appliance manufacturer and are installed in accordance with the manufacturer's instructions.

507.2.3 Domestic cooking appliances used for commercial purposes. Domestic cooking appliances utilized for commercial purposes shall be provided with Type I or Type II hoods as required for the type of appliances and processes in accordance with Sections 507.2, 507.2.1 and 507.2.2.

507.2.4 Solid fuel. Type I hoods for use over solid fuel-burning cooking appliances shall discharge to an exhaust system that is independent of other exhaust systems.

507.3 Fuel-burning appliances. Where vented fuel-burning appliances are located in the same room or space as the hood, provisions shall be made to prevent the hood system from interfering with normal operation of the appliance vents.

507.4 Type I materials. Type I hoods shall be constructed of steel not less than 0.043 inch (1.09 mm) (No. 18 MSG) in thickness, or stainless steel not less than 0.037 inch (0.94 mm) (No. 20 MSG) in thickness.

507.5 Type II hood materials. Type II hoods shall be constructed of steel not less than 0.030 inch (0.76 mm) (No. 22 Gage) in thickness, stainless steel not less than 0.024 inch (0.61 mm) (No. 24 Gage) in thickness, copper sheets weighing not less than 24 ounces per square foot (7.3 kg/m²), or of other approved material and gage.

507.6 Supports. Type I hoods shall be secured in place by non-combustible supports. All Type I and Type II hood supports shall be adequate for the applied load of the hood, the unsupported ductwork, the effluent loading, and the possible weight of personnel working in or on the hood.

507.7 Hood joints, seams and penetrations. Hood joints, seams and penetrations shall comply with Sections 507.7.1 and 507.7.2.

507.7.1 Type I hoods. External hood joints, seams and penetrations for Type I hoods shall be made with a continuous external liquid-tight weld or braze to the lowest outermost perimeter of the hood. Internal hood joints, seams, penetrations, filter support frames, and other appendages attached inside the hood shall not be required to be welded or brazed but shall be otherwise sealed to be grease tight.

Exceptions:

1. Penetrations shall not be required to be welded or brazed where sealed by devices that are listed for the application.
2. Internal welding or brazing of seams, joints, and penetrations of the hood shall not be prohibited provided that the joint is formed smooth or ground so as to not trap grease, and is readily cleanable.

507.7.2 Type II hoods. Joints, seams and penetrations for Type II hoods shall be constructed as set forth in Chapter 6, shall be sealed on the interior of the hood and shall provide a smooth surface that is readily cleanable and water tight.

507.8 Cleaning and grease gutters. A hood shall be designed to provide for thorough cleaning of the entire hood. Grease gutters shall drain to an approved collection receptacle that is fabricated, designed and installed to allow access for cleaning.

507.9 Clearances for Type I hood. A Type I hood shall be installed with a clearance to combustibles of not less than 18 inches (457 mm).

Exception: Clearance shall not be required from gypsum wallboard attached to noncombustible structures provided that a smooth, cleanable, nonabsorbent and noncombustible material is installed between the hood and the gypsum wallboard over an area extending not less than 18 inches (457 mm) in all directions from the hood.

507.10 Hoods penetrating a ceiling. Type I hoods or portions thereof penetrating a ceiling, wall or furred space shall comply with all the requirements of Section 506.3.10.

507.11 Grease filters. Type I hoods shall be equipped with listed grease filters designed for the specific purpose. Grease-collecting equipment shall be provided with access for cleaning. The lowest edge of a grease filter located above the cooking surface shall be not less than the height specified in Table 507.11.

**TABLE 507.11
MINIMUM DISTANCE BETWEEN THE LOWEST EDGE OF A
GREASE FILTER AND THE COOKING SURFACE OR THE
HEATING SURFACE**

TYPE OF COOKING APPLIANCES	HEIGHT ABOVE COOKING SURFACE (feet)
Without exposed flame	0.5
Exposed flame and burners	2
Exposed charcoal and charbroil type	3.5

For SI: 1 foot = 304.8 mm.

507.11.1 Criteria. Filters shall be of such size, type and arrangement as will permit the required quantity of air to pass through such units at rates not exceeding those for which the filter or unit was designed or approved. Filter units shall be

installed in frames or holders so as to be readily removable without the use of separate tools, unless designed and installed to be cleaned in place and the system is equipped for such cleaning in place. Removable filter units shall be of a size that will allow them to be cleaned in a dishwashing machine or pot sink. Filter units shall be arranged in place or provided with drip-intercepting devices to prevent grease or other condensate from dripping into food or on food preparation surfaces.

507.11.2 Mounting position. Filters shall be installed at an angle of not less than 45 degrees (0.79 rad) from the horizontal and shall be equipped with a drip tray beneath the lower edge of the filters.

507.12 Canopy size and location. The inside lower edge of canopy-type commercial cooking hoods shall overhang or extend a horizontal distance of not less than 6 inches (152 mm) beyond the edge of the cooking surface, on all open sides. The vertical distance between the front lower lip of the hood and the cooking surface shall not exceed 4 feet (1219 mm).

Exception: The hood shall be permitted to be flush with the outer edge of the cooking surface where the hood is closed to the appliance side by a noncombustible wall or panel.

507.13 Capacity of hoods. Commercial food service hoods shall exhaust a minimum net quantity of air determined in accordance with this section and Sections 507.13.1 through 507.13.4. The net quantity of exhaust air shall be calculated by subtracting any airflow supplied directly to a hood cavity from the total exhaust flow rate of a hood. Where any combination of extra-heavy-duty, heavy-duty, medium-duty, and light-duty cooking appliances are utilized under a single hood, the highest exhaust rate required by this section shall be used for the entire hood.

507.13.1 Extra-heavy-duty cooking appliances. The minimum net airflow for Type I hoods used for extra-heavy-duty cooking appliances shall be determined as follows:

Type of Hood	CFM per linear foot of hood
Wall-mounted canopy	550
Single island canopy	700
Double island canopy (per side)	550
Backshelf/pass-over	Not allowed
Eyebrow	Not allowed

For SI: 1 cfm per linear foot = 1.55 L/s per linear meter.

507.13.2 Heavy-duty cooking appliances. The minimum net airflow for Type I hoods used for heavy-duty cooking appliances shall be determined as follows:

Type of Hood	CFM per linear foot of hood
Wall-mounted canopy	400
Single island canopy	600
Double island canopy (per side)	400
Backshelf/pass-over	400
Eyebrow	Not allowed

For SI: 1 cfm per linear foot = 1.55 L/s per linear meter.

507.13.3 Medium-duty cooking appliances. The minimum net airflow for Type I hoods used for medium-duty cooking appliances shall be determined as follows:

Type of Hood	CFM per linear foot of hood
Wall-mounted canopy	300
Single island canopy	500
Double island canopy (per side)	300
Backshelf/pass-over	300
Eyebrow	250

For SI: 1 cfm per linear foot = 1.55 L/s per linear meter.

507.13.4 Light-duty cooking appliances. The minimum net airflow for Type I hoods used for light duty cooking appliances and food service preparation and cooking operations approved for use under a Type II hood shall be determined as follows:

Type of Hood	CFM per linear foot of hood
Wall-mounted canopy	200
Single island canopy	400
Double island canopy (per side)	250
Backshelf/pass-over	250
Eyebrow	250

For SI: 1 cfm per linear foot = 1.55 L/s per linear meter.

507.14 Noncanopy size and location. Noncanopy-type hoods shall be located a maximum of 3 feet (914 mm) above the cooking surface. The edge of the hood shall be set back a maximum of 1 foot (305 mm) from the edge of the cooking surface.

507.15 Exhaust outlets. Exhaust outlets located within the hood shall be located so as to optimize the capture of particulate matter. Each outlet shall serve not more than a 12-foot (3658 mm) section of hood.

507.16 Performance test. A performance test shall be conducted upon completion and before final approval of the installation of a ventilation system serving commercial cooking appliances. The test shall verify the rate of exhaust airflow required by Section 507.13, makeup airflow required by Section 508, and proper operation as specified in this chapter. The permit holder shall furnish the necessary test equipment and devices required to perform the tests.

507.16.1 Capture and containment test. The permit holder shall verify capture and containment performance of the exhaust system. This field test shall be conducted with all appliances under the hood at operating temperatures. Capture and containment shall be verified visually by observing smoke or steam produced by actual or simulated cooking, such as with smoke candles, smoke puffers, etc.

SECTION 508 COMMERCIAL KITCHEN MAKEUP AIR

508.1 Makeup air. Makeup air shall be supplied during the operation of commercial kitchen exhaust systems that are provided for commercial cooking appliances. The amount of

EXHAUST SYSTEMS

makeup air supplied shall be approximately equal to the amount of exhaust air. The makeup air shall not reduce the effectiveness of the exhaust system. Makeup air shall be provided by gravity or mechanical means or both. For mechanical makeup air systems, the exhaust and makeup air systems shall be electrically interlocked to insure that makeup air is provided whenever the exhaust system is in operation. Makeup air intake opening locations shall comply with Sections 401.5 and 401.5.1.

508.1.1 Makeup air temperature. The temperature differential between makeup air and the air in the conditioned space shall not exceed 10°F (6°C).

Exceptions:

1. Makeup air that is part of the air-conditioning system.
2. Makeup air that does not decrease the comfort conditions of the occupied space.

508.2 Compensating hoods. Manufacturers of compensating hoods shall provide a label indicating minimum exhaust flow and/or maximum makeup airflow that provides capture and containment of the exhaust effluent.

SECTION 509 FIRE SUPPRESSION SYSTEMS

509.1 Where required. Commercial cooking appliances required by Section 507.2.1 to have a Type I hood shall be provided with an approved automatic fire suppression system complying with the *International Building Code* and the *International Fire Code*.

SECTION 510 HAZARDOUS EXHAUST SYSTEMS

510.1 General. This section shall govern the design and construction of duct systems for hazardous exhaust and shall determine where such systems are required. Hazardous exhaust systems are systems designed to capture and control hazardous emissions generated from product handling or processes, and convey those emissions to the outdoors. Hazardous emissions include flammable vapors, gases, fumes, mists or dusts, and volatile or airborne materials posing a health hazard, such as toxic or corrosive materials. For the purposes of this section, the health-hazard rating of materials shall be as specified in NFPA 704.

510.2 Where required. A hazardous exhaust system shall be required wherever operations involving the handling or processing of hazardous materials, in the absence of such exhaust systems and under normal operating conditions, have the potential to create one of the following conditions:

1. A flammable vapor, gas, fume, mist or dust is present in concentrations exceeding 25 percent of the lower flammability limit of the substance for the expected room temperature.
2. A vapor, gas, fume, mist or dust with a health-hazard rating of 4 is present in any concentration.

3. A vapor, gas, fume, mist or dust with a health-hazard rating of 1, 2 or 3 is present in concentrations exceeding 1 percent of the median lethal concentration of the substance for acute inhalation toxicity.

[F] 510.2.1 Lumber yards and woodworking facilities.

Equipment or machinery located inside buildings at lumber yards and woodworking facilities which generates or emits combustible dust shall be provided with an approved dust-collection and exhaust system installed in conformance with this section and the *International Fire Code*. Equipment and systems that are used to collect, process or convey combustible dusts shall be provided with an approved explosion-control system.

[F] 510.2.2 Combustible fibers. Equipment or machinery within a building which generates or emits combustible fibers shall be provided with an approved dust-collecting and exhaust system. Such systems shall comply with this code and the *International Fire Code*.

510.3 Design and operation. The design and operation of the exhaust system shall be such that flammable contaminants are diluted in noncontaminated air to maintain concentrations in the exhaust flow below 25 percent of the contaminant's lower flammability limit.

510.4 Independent system. Hazardous exhaust systems shall be independent of other types of exhaust systems. Incompatible materials, as defined in the *International Fire Code*, shall not be exhausted through the same hazardous exhaust system. Hazardous exhaust systems shall not share common shafts with other duct systems, except where such systems are hazardous exhaust systems originating in the same fire area.

Contaminated air shall not be recirculated to occupied areas unless the contaminants have been removed. Air contaminated with explosive or flammable vapors, fumes or dusts; flammable or toxic gases; or radioactive material shall not be recirculated.

510.5 Design. Systems for removal of vapors, gases and smoke shall be designed by the constant velocity or equal friction methods. Systems conveying particulate matter shall be designed employing the constant velocity method.

510.5.1 Balancing. Systems conveying explosive or radioactive materials shall be prebalanced by duct sizing. Other systems shall be balanced by duct sizing with balancing devices, such as dampers. Dampers provided to balance air-flow shall be provided with securely fixed minimum-position blocking devices to prevent restricting flow below the required volume or velocity.

510.5.2 Emission control. The design of the system shall be such that the emissions are confined to the area in which they are generated by air currents, hoods or enclosures and shall be exhausted by a duct system to a safe location or treated by removing contaminants.

510.5.3 Hoods required. Hoods or enclosures shall be used where contaminants originate in a limited area of a space. The design of the hood or enclosure shall be such that air currents created by the exhaust systems will capture the contaminants and transport them directly to the exhaust duct.



Henckel Design and Fabrication

134 Hartley Street
Portland, Maine
04103

Phone: 1-207-318-2623
Fax: 1-207-772-8952
E-mail: petehenckel@maine.rr.com

09/13/06

September 13, 2006

Site location
#135 Walton St
Portland Me 04103

Izzys cheese Cake

Attn; Mike Collins

From Pete Henckel

Mike here is the information that you requested for the cut sheets on the equipment located Under the new hood as well as the cut sheet for the fan that is to be installed the site drawing And photos will be ready some time tomorrow and sent to you as I receive them thank you for your time.

- Restaurant Hoods • Boiler Breaching • HVAC Design • Curb Adapters and Unit Installations •
- Welded Ducting • Custom Welding Fabrication •

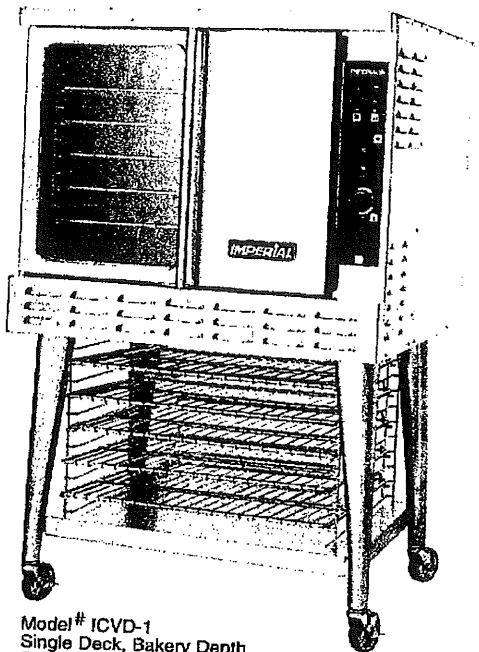

Model # ICVD-1
Single Deck, Bakery Depth
Shown with Manual Controls,
and Optional Storage Shelf,
Racks and Casters

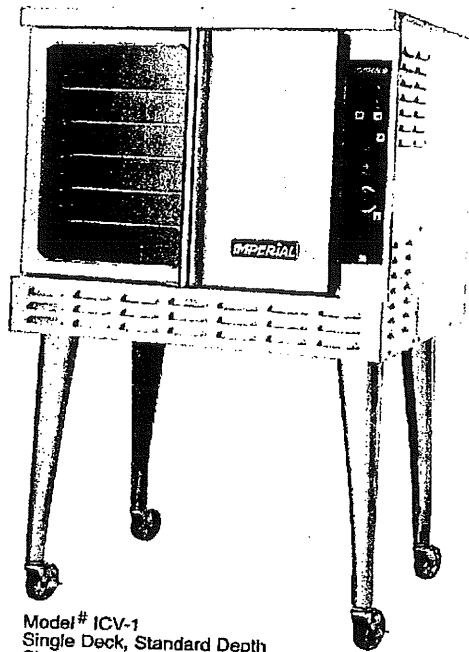

Model # ICV-1
Single Deck, Standard Depth
Shown with Manual Controls
and optional casters

Model #	Description	Overall Dimensions			Gas Output		Ship Weight		List Price
		Width	Height	Depth	BTU	(KW)	(Kg)	Lbs	
ICV-1	Single Deck, Standard depth	38"	60"	40 1/4"	70,000	21	236	521	\$6657
ICV-2	Double Deck, Standard depth	38"	74"	40 1/4"	140,000	41	455	1005	13,313
ICVD-1	Single Deck, Bakery depth	38"	60"	44 1/4"	80,000	23	277	611	8643
ICVD-2	Double Deck, Bakery depth	38"	74"	44 1/4"	160,000	47	536	1185	17,287

Note: For Cook and Hold computer control feature add the suffix
"- H" for one oven or "- HH" if required for both ovens.

Rated Dimensions: Add 2" to width; 7" to depth; and 3" to oven cabinet height.



- Cook and Hold Feature \$1005 per Oven.
- Stainless Steel doors, sides, top and legs are standard on all ICV and ICVD Models.
- Stainless Steel Enclosure Back \$320 per Deck.
- Direct Connect Vent ICV-1 #23130 \$263, ICV-2 #23135 \$525.
- Heavy Duty Casters, set of 4 \$431.
- Stack Kit with 6" Stainless Steel Legs #23140 \$633.
- Stainless Steel solid doors available at no additional charge. Must specify at ordering.
- 208/240 Motor and Transformer \$651.
- Stainless Steel Bottom Shelf and Adjustable Rack Supports
ICV-1 #28330 \$617, ICVD-1 #28331 \$753.
- Stainless Steel Stand Bottom Shelf only
ICV-1 #22011 \$342,
ICVD-1 #22211 \$411.
- Extra Standard Oven Racks,
ICV-1 #2040 \$130 each.
- Extra Bakery Depth Oven Racks.

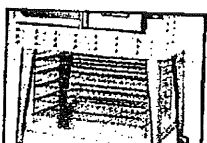

Gas Requirements

Manifold pressure 5.0" W.C. Natural Gas
10.0" W.C. Propane Gas
Manifold size 3/4" N.P.T.
Input Rating 70,000 BTU (per oven- ICV)
80,000 BTU (per oven- ICVD)

Electrical Requirements

120 VAC, 1ph, 60 Hz, 9 Amps Max. (per oven)
Two speed motor - 1/2 h.p., 1725/1140 RPM.
Optional 208/240 motor required for CE certified models.

Minimum Clearance

For use only on non-combustible floors with legs or casters; or 2 1/4" overhang is required when curb mounted.
0" clearance from non-combustible side and rear walls.
Provide 6" minimum clearance from combustible side walls and 0" from combustible wall at rear.

CONVECTION OVENS

Home | Order Form | Compare Items | Register | Your Account | Help

Repair Parts Services Resources Company Info Contact Us Find A Branch Worldwide



Search

Catalog No. 397 (PDF) Keyword(s)



LOGIN

User ID

Password



Remember my login

Item Details

HVAC > Exhaust Fans > Direct Drive Centrifugal Exhaust Vents

Exhaust Vent, 16 1/2 In

Exhaust Ventilator, Centrifugal Upblast Direct Drive, CFM @ 0.000-In SP 2472, @ 0.250-In SP 2126, @ 0.500-In SP 1680, 9.9 Sones @ 0.250-In SP, Roof Mounting Location, Base Width 26 In, Base Length 26 In, Max Inlet Temp 300 F, Motor Voltage 115, 1 Phase, Motor HP 1/4, 860 RPM, Wheel Dia 16 1/2 In, Speed Controllable Except For Kitchen Applications, Requires Roof Curb For New Installation, Includes NEMA 1 Junction Box

Grainger Item #

Price (ea.)

Brand

Mfr. Model #

Ship Qty.

Sell Qty. (Will-Call)

Ship Weight (lbs.)

Usually Ships**

Catalog Page No.

4HZ52

\$914.00

DAYTON

4HZ52

1

1

76.0

Today

4024

Qty.



Enlarge Image



Price shown may not reflect your price. Log in or register.

Tech Specs Additional Information Notes & Restrictions MSDS Required Accessories Optional Products Repair Parts

Item Exhaust Ventilator

Type Centrifugal Upblast Direct Drive

Wheel Dia (In)

16 1/2

MODEL 961/961P



APPROVAL/STAMP

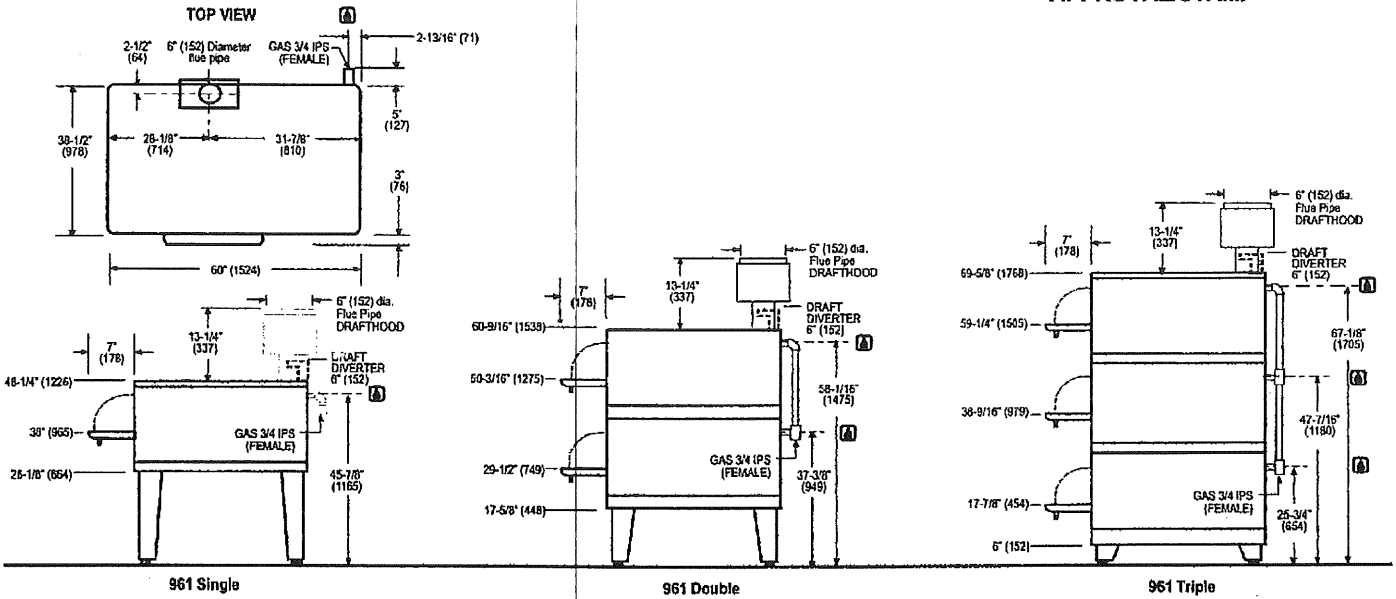

SHORT FORM SPECIFICATIONS

Provide Blodgett (single/double/triple) deck oven, model 961. Construction shall be welded stainless steel front, top, back and sides, and shall be fully insulated on all sides. Oven shall be supported by formed adjustable legs. Door(s) shall be counterbalanced (no springs) with concealed hinges and chrome plated tubular steel handles. Separate burner door provided for ignition, cleaning and adjustment. Each baking compartment shall be 42" W x 7" H x 32" D and shall be lined with aluminized steel. Deck shall be 11 gauge press-formed, reinforced and flanged steel. Unit shall be gas heated by a free-floating, easily removable, duplex-type burner controlled by a liquid pressure thermostat with range of 300°F to 500°F (961) or 300°F to 650°F (961P). Each compartment provided with flue vent. Provide with two year limited parts and labor warranty. Provide with options and accessories as indicated.

DIMENSIONS:	Single	Double	Triple
Number of sections:	1	2	3
Number of controls:	1	2	3
Number of compartments:	1	2	3
Size of compartment:	42" (1067mm) W x 7" (178mm) H x 32" (813mm) D		
Area of each compartment:	9.34 sq. ft. (0.87m ²)		
Total area of oven:	9.34 sq. ft. (0.87m ²)	18.68sq. ft. (1.74m ²)	28.02sq. ft. (2.60m ²)
Clearance below oven:	26-1/8" (664mm)	17-5/8" (448mm)	6" (152mm)
Floor space:	60" (1524mm) wide x 40" (1016mm) deep		
Product clearance:	6" from combustible and non-combustible construction		

PAN CAPACITIES:	Single	Double	Triple
10" (254mm) pie tins:	12	24	36
18" x 26" (457mm x 660mm) bun pans:	2	4	6
9-1/2" x 5" (241mm x 127mm) bread pans:	24	48	72
9" x 7" (228mm x 178mm) roll pans:	16	32	48
19" x 4" (483mm x 102mm) pullman pans:	14	28	42
13" x 16-1/2" (330mm x 419mm) cup tins:	9	18	27
20" x 28" (508mm x 711mm) roast pans:	2	4	6
No. 200 pans (324mm x 527mm):	4	8	12
Bean pots #1:	35	70	105
#3:	20	40	60
#6:	12	24	36

GAS SUPPLY:
 3/4" IPS connection at rear of oven
 Manifold Pressure:
 • Natural – 5" W.C • Propane – 10" W.C.
 Inlet Pressure:
 • Natural – 7.0" W.C. min. – 10.5" W.C. max.
 • Propane – 11.0" W.C. min. – 13.0" W.C. max.

MAXIMUM INPUT:	911	911P
Single	37,000 BTU/hr	50,000 BTU/hr
Double	74,000 BTU/hr	100,000 BTU/hr
Triple	111,000 BTU/hr	150,000 BTU/hr

MINIMUM ENTRY CLEARANCE:
 Uncrated 23-1/4" (591mm)
 Crated 27" (686mm)

SHIPPING INFORMATION:
 Approx. Weight: Crated Uncrated
 Single: 560 lbs. (254kg) 520 lbs. (236kg)
 Double: 1120 lbs. (507kg) 1040 lbs. (471kg)
 Triple: 1680 lbs. (761kg) 1560 lbs. (707kg)

Crate sizes:
 65" (1651mm) x 46" (1168mm) x 27" (686mm)

NOTE: The company reserves the right to make substitutions of components without prior notice

BLODGETT OVEN COMPANY

www.maytagfoodservice.com

50 Lakeside Avenue, Burlington, VT 05402

Toll Free: (800) 331-5842 • Phone: (802) 860-3700 • Fax: (802) 864-0183

Printed in U.S.A.

NOTE: FOR COMMERCIAL USE ONLY

P/N 35029 Rev F (5/01)



MODEL 961/961P
Deck Oven

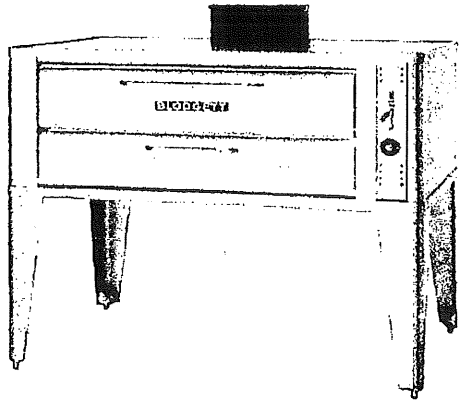

OPTIONS AND ACCESSORIES
(AT ADDITIONAL CHARGE)

- **Legs:**
 - 7" (178mm) black powder coated legs
 - 7" (178mm) stainless steel legs
 - 19" (483mm) black powder coated legs
 - 19" (483mm) stainless steel legs
 - 27-1/2" (699mm) black powder coated legs
 - 27-1/2" (699mm) stainless steel legs
- Casters
- Stainless steel crown angle trim
- Vent kit
- Double or triple connector for stacking
- Ultra Rokite shelves, 1-1/2" (38.1mm) thick (pizza type shelf)
- Steam jets

OPTIONS AND ACCESSORIES
(AT NO ADDITIONAL CHARGE)

- 961 - FDTH 300°F (149°C) to 650°F (343°C) temperature thermostat
- Centigrade dial, 100°C to 300°C

Item No. _____
Quantity _____

Ovens consist of basic sections and are a complete and separate unit capable of operating alone or in combination.
All data is shown per oven section, unless otherwise indicated.

EXTERIOR CONSTRUCTION

- Full angle iron frame
- Stainless steel front, top and sides
- Aluminized steel back
- Counterbalanced doors with concealed hinges
- Heavy chrome plated tubular steel door handle
- Burner doors open easily for ignition, cleaning or adjustment, without removal of any fastenings
- Vitreous fiber insulation at top, back, sides, bottom and doors

INTERIOR CONSTRUCTION

- 42" x 32" x 7" (1067mm x 813mm x 178mm) oven compartment interior
- Aluminized steel baking compartment liner
- Aluminized steel combustion chamber
- Steel deck supported by an angle iron frame
- 12 gauge (3.02mm) press-formed, reinforced and flanged aluminized steel deck

OPERATION

- Free-floating, easily removable duplex-tube burner
- Removable fixed orifices on main and pilot burner
- Main gas valve, temperature control valve and safety pilot valve fully within section body and are accessible through a covered and ventilated compartment in front.
- Air mixers with adjustable air shutters and locking device
- 961 - Liquid pressure thermostat with temperature control range of 300°F(149°C) to 500°F (288°C)
- 961P - Liquid pressure thermostat with temperature control range of 300°F (149°C) to 650°F (343°C)

STANDARD FEATURES

- 961 - Fahrenheit dial 300° to 500°
- 961P - Fahrenheit dial 300° to 650°
- Steel oven deck
- Two year limited parts and labor warranty*

* For all international markets, contact your local distributor.



BLODGETT OVEN COMPANY

www.maytagfoodservice.com

50 Lakeside Avenue, Burlington, VT 05402

Toll Free: (800) 331-5842 • Phone: (802) 860-3700 • Fax: (802) 864-0183

/961P - Single/Double/Triple



Henckel Design and Fabrication

134 Hartley Street
Portland, Maine
04103

Phone: 1-207-318-2623

Fax: 1-207-772-8952

E-mail: petehenckel@maine.rr.com

September 18, 2006

ATTN MIKE COLLINS
FROM PETE HENCKEL
135 WALTON ST
IZZYS CHEESE CAKE

• Restaurant Hoods • Boiler Breaching • HVAC Design • Curb Adapters and Unit Installations •
• Welded Ducting • Custom Welding Fabrication •



Henckel Design and Fabrication

134 Hartley Street
Portland, Maine
04103

Phone: 1-207-318-2623

Fax: 1-207-772-8952

E-mail: petehenckel@maine.rr.com

September 18, 2006

- Restaurant Hoods • Boiler Breaching • HVAC Design • Curb Adapters and Unit Installations •
- Welded Ducting • Custom Welding Fabrication •

**Henckel Design and Fabrication**

134 Hartley Street
Portland, Maine
04103

Phone: 1-207-318-2623

Fax: 1-207-772-8952

E-mail: petehenckel@maine.rr.com

September 18, 2006

Mike,

Because of the size of the hood it will be made of eight side panels that will make up the Exterior of the hood and assembled on site once the exterior panels are welded together The top panels will be installed and the lift points welded in place.

The fan is located very close to the center of the hood on the roof it has been placed so That it is a minimum of 10' away of any intake system for code it has yet to be roofed in That will take place after the permit has been issued.

• Restaurant Hoods • Boiler Breaching • HVAC Design • Curb Adapters and Unit Installations •
• Welded Ducting • Custom Welding Fabrication •



Henckel Design and Fabrication

134 Hartley Street
Portland, Maine
04103

Phone: 1-207-318-2623
Fax: 1-207-772-8952
E-mail: petehenckel@maine.rr.com

September 18, 2006

16 Ga Galvanized G60 METAL

3 Sides painted:

1/2" x 1/8" Black IRON STIFFENER

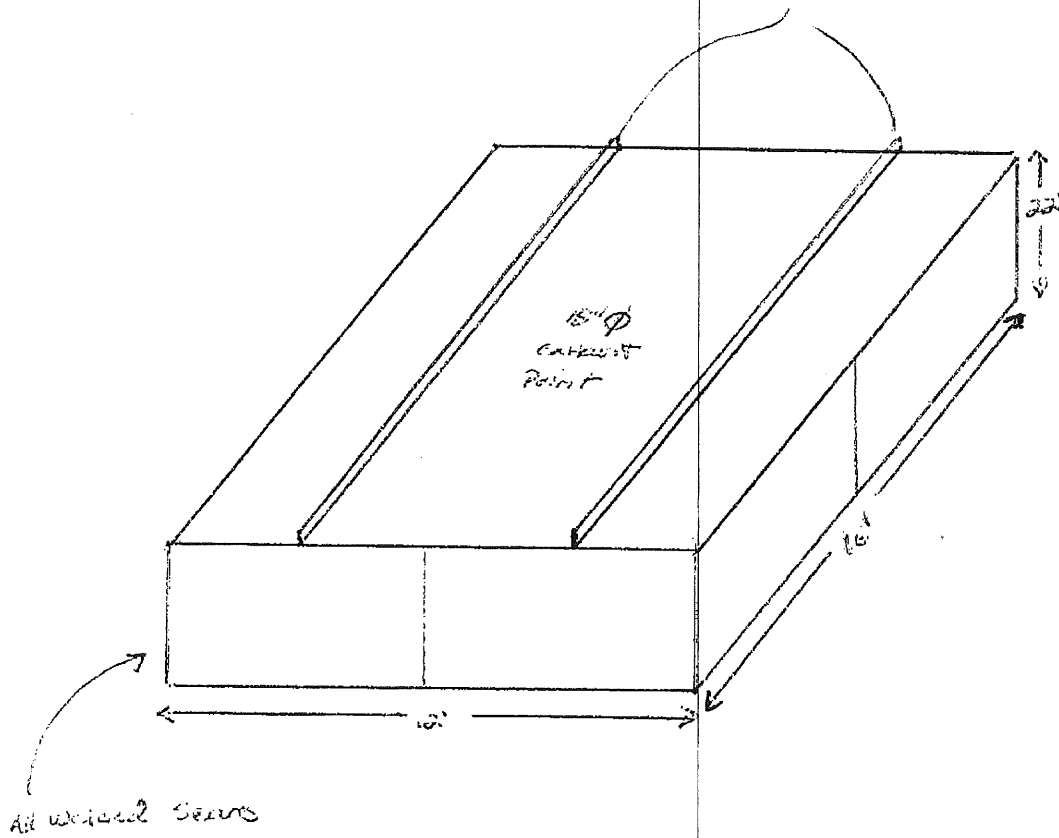

- Restaurant Hoods • Boiler Breaching • HVAC Design • Curb Adapters and Unit Installations •
- Welded Ducting • Custom Welding Fabrication •

135 WALTON ST
PARKLAND MA
IZZY'S & HOUSE
CARE

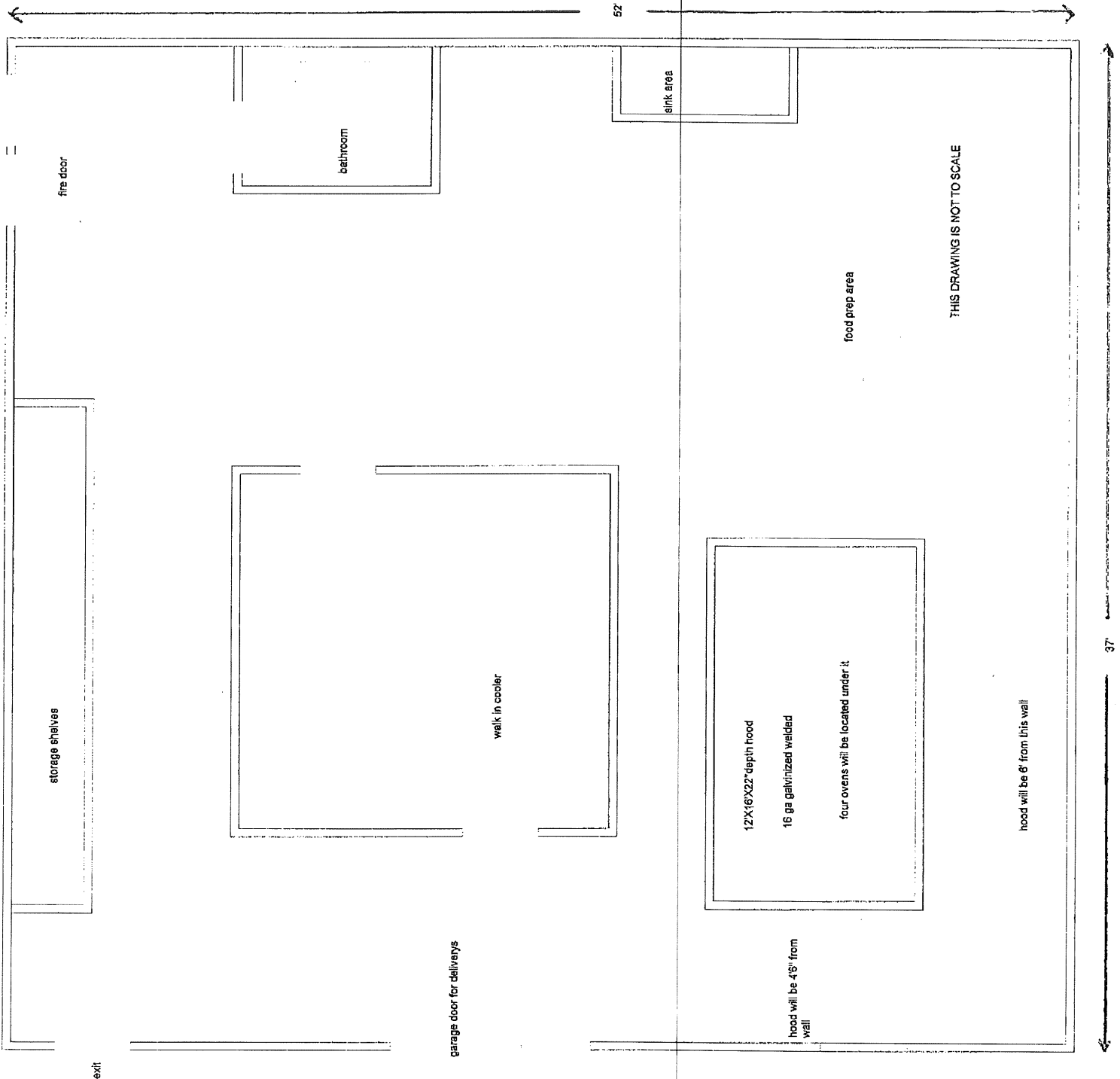



Henckel Design and Fabrication

134 Hartley Street
Portland, Maine
04103

Phone: 1-207-318-2623
Fax: 1-207-772-8952
E-mail: petehenckel@maine.rr.com

September 19, 2006

ATTN; MIKE COLLINS

FROM PETE HENCKEL

IZZYS CHEESE CAKE
135 WALTON ST

- Restaurant Hoods • Boiler Breaching • HVAC Design • Curb Adapters and Unit Installations •
- Welded Ducting • Custom Welding Fabrication •



Henckel Design and Fabrication

134 Hartley Street
Portland, Maine
04103

Phone: 1-207-318-2623
Fax: 1-207-772-8952
E-mail: petehenckel@maine.rr.com

September 18, 2006

(15A Fire Shield where the DOOR MEETS THE ROOF)

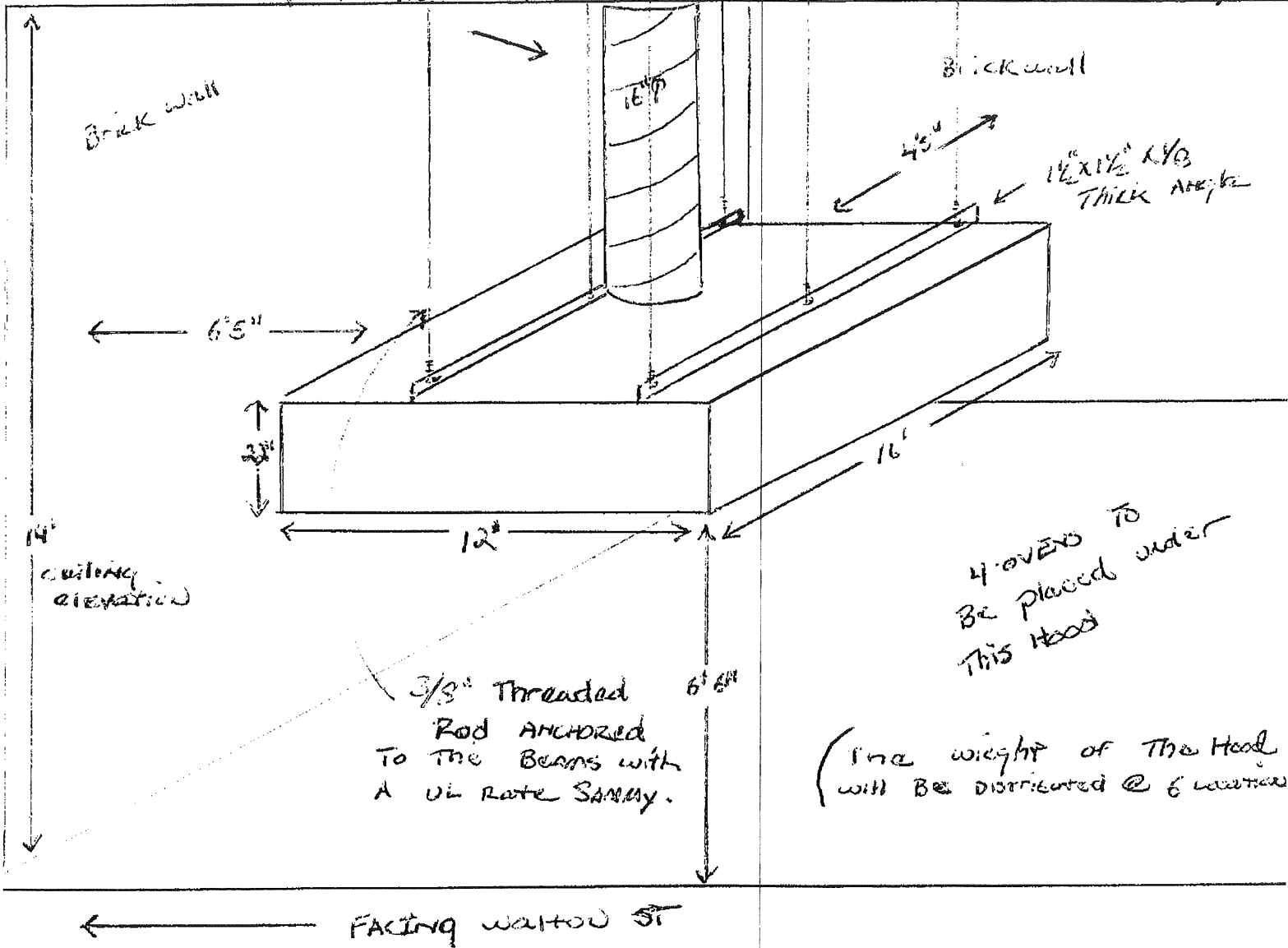

- Restaurant Hoods • Boiler Breaching • HVAC Design • Curb Adapters and Unit Installations •
- Welded Ducting • Custom Welding Fabrication •

ELECTRICAL PERMIT

City of Portland, Me.



To the Chief Electrical Inspector, Portland Maine:
 The undersigned hereby applies for a permit to make electrical installations
 in accordance with the laws of Maine, the City of Portland Electrical Ordinance,
 National Electrical Code and the following specifications:

Date _____

Permit # 2006-4898

CBL# 142I 1

LOCATION: 135 WALTON ST METER MAKE & # _____
 CMP ACCOUNT # _____ OWNER JZZY'S CHEESECAKE
 TENANT _____ PHONE # _____

							TOTAL EACH FEE	
OUTLETS	8	Receptacles	2	Switches		Smoke Detector		.20
FIXTURES		Incandescent	6	Fluorescent		Strips		.20
SERVICES		Overhead		Underground		TTL AMPS <800		15.00
		Overhead		Underground		>800		25.00
Temporary Service		Overhead		Underground		TTL AMPS		25.00
								25.00
METERS		(number of)						1.00
MOTORS		(number of)						2.00
RESID/COM		Electric units						1.00
HEATING		oil/gas units		Interior		Exterior		5.00
APPLIANCES		Ranges		Cook Tops		Wall Ovens		2.00
		Insta-Hot		Water heaters	1	Fans		2.00
		Dryers		Disposals		Dishwasher		2.00
		Compactors		Spa		Washing Machine		2.00
		Others (denote)						2.00
MISC. (number of)		Air Cond/win						3.00
		Air Cond/cent				Pools		10.00
		HVAC		EMS		Thermostat		5.00
		Signs						10.00
		Alarms/res						5.00
		Alarms/com						15.00
		Heavy Duty(CRKT)						2.00
		Circus/Carnv						25.00
		Alterations						5.00
		Fire Repairs						15.00
	E Lights						1.00	
	E Generators						20.00	
PANELS		Service		Remote		Main		4.00
TRANSFORMER		0-25 Kva						5.00
		25-200 Kva						8.00
		Over 200 Kva						10.00
							TOTAL AMOUNT DUE	
							MINIMUM FEE/COMMERCIAL	55.00
							MINIMUM FEE	45.00

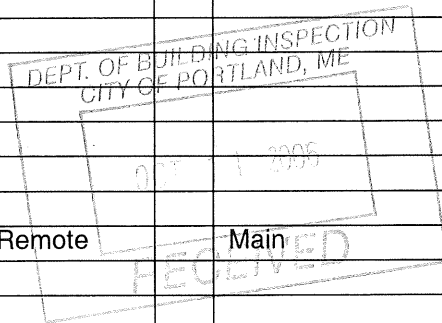

CONTRACTORS NAME SANDERSON ELECTRIC MASTER LIC. # MS 6000, 1,5120
 ADDRESS 123 MOSHER RD. GORHAM ME LIMITED LIC. # _____
 TELEPHONE 207 838 7413

SIGNATURE OF CONTRACTOR [Signature] [Signature]