

BUDERUS

Cast Iron Residential
G115WS

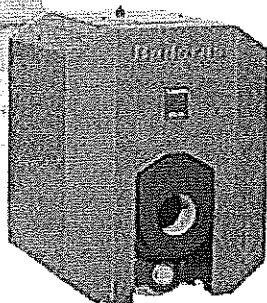

The G115WS—designed and engineered to extract and deliver more heat from every fuel dollar.

Increase Comfort and Reduce Heating Costs.

Comfortable. Efficient. Intelligent Heating.

Buderus



G115WS Series

A better way to heat your home

The Buderus G115WS boiler is based on the highly successful G115, the world's best selling boiler. The G115WS has been redesigned and reengineered to extract and deliver more heat from every fuel dollar, and now has higher outputs at less cost per BTU. Acknowledged as the leader in high-efficiency, low emission hydronic heating, Buderus offers innovative design and quality manufacturing with exceptional efficiency and performance.

A G115WS cast iron oil boiler is ideal for new installations or as a replacement for virtually any make or model of boiler. They are compatible with most hot water tanks. Constructed with superior materials and designed by the industry's leading engineers, the G115WS boiler is raising the standard for the industry. With two ETL approved venting options, either into a chimney or directly through the wall, the G115WS allows a wide range of installation possibilities.

Comfortable

Keeping your home comfortable and warm is a high priority—but it doesn't have to come at a high cost. Whether you heat by baseboard, panel radiators, hydro-air systems or radiant flooring, our advanced heating systems will provide many years of exceptional comfort and economy. A conventional boiler heats and circulates water at only one temperature—typically 170° to 180° F until the thermostat signals it to stop. A Buderus boiler, especially when paired with the Logomatic control, eliminates these room temperature swings by adjusting the boiler water temperature to the current conditions, saving fuel while keeping you warm and comfortable.

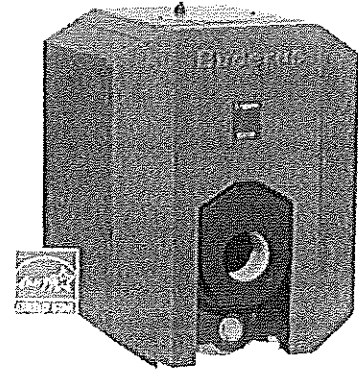

Special compounds provide a gas-tight seal for safe and efficient operation. And, thanks to the GL-180M cast iron's amazing flexibility, this boiler resists thermal shock under conditions of rapid temperature change without the need for additional piping or controls.

The three-pass boiler is designed for

- Optimized combustion with positive pressure-fired boilers and tailored chamber geometry — no need for a heat-consuming refractory or target wall eliminating the need for costly repairs.
- Minimal stack losses with the modified three-pass flue design's large heat transfer areas.
- Low standby losses with a full 3" jacket of thermal insulation around the entire block—even underneath the boiler!

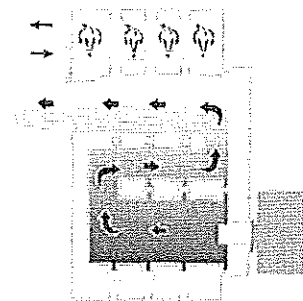

How it works

The flame fires into the first chamber. Then the flue products flow through the second pass to the front of the boiler. From there they reverse direction again—moving through the third pass to the back, and finally exiting via the flue connection into the chimney. Because the gases are held in the boiler longer this allows the cast iron to absorb the maximum amount of heat, resulting in a lower stack temperature and a higher efficiency.

BUDERUS Cast Iron Residential Oil Boiler G115WS

Efficient

Energy Star ratings for boilers are based on an Annual Fuel Utilization Efficiency (AFUE) rating, which is a ratio of the heat produced to the energy consumed on an annual basis. Not only is the Buderus G115WS boiler ENERGY STAR certified, but it is also designed for ease of installation and maintenance. With features like compact dimension and integrated handles for ease of transporting, adjustable leveling legs, rear tappings and flue connection, baffles and clips for adjusting stack temperatures and a heavy gauge blue enameled jacket, a Buderus boiler is not only efficient, but it is easy to install.

A full swing burner door, which can be hinged on either the left or the right, and front access plugs which permit flushing of the boiler's interior, allow the G115WS to be thoroughly and properly cleaned in a fraction of the time it takes to clean a conventional boiler.

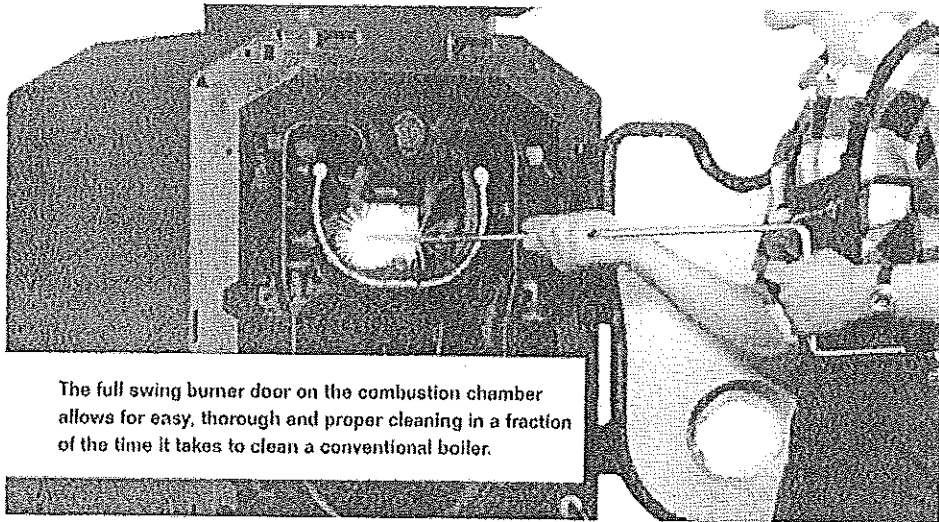
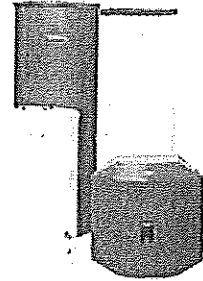

The full swing burner door on the combustion chamber allows for easy, thorough and proper cleaning in a fraction of the time it takes to clean a conventional boiler.

Domestic Hot Water Tanks

Need domestic hot water? Then combine your Buderus boiler with a Buderus indirect hot water tank. A Buderus tank is well insulated for minimal stand-by heat loss. Available in a vertical, or a horizontal space saving model that installs under the boiler, these tanks have a higher recovery rate than stand alone or tankless coil models. While a Buderus boiler works great with any hot water tank—you can be sure of increased boiler efficiency, system longevity, and minimized service calls when you insist on a Buderus tank and boiler.

Intelligent heating—by design

The G115WS is designed in Germany where fuel costs are significantly higher and environmental regulations are more stringent. Using state of the art techniques in the design and manufacturing process, the G115WS is built to maximize the heating value of every ounce of fuel and is constructed with the highest quality materials.

Manufactured without a heat-consuming refractory or target wall, service and maintenance calls are minimized, while fuel efficiency and heat transfer is maximized. The patented Buderus GL-180M flexible cast iron ensures that the boiler resists thermal shock under conditions of rapid temperature change. Sections are securely joined together and sealed by profiled, beveled steel push nipples, ensuring a long life with no leakage. Special compounds provide a gas-tight seal for safe and efficient operation. The full 3" thermal insulation around the boiler, including underneath, increases efficiency by almost eliminating standby and stack temperature losses.

Buderus, the world leader in heating technology, manufactures the highest quality boilers based on two centuries of experience. With its innovative design and quality manufacturing, a Buderus boiler will outlast and out-perform virtually any other residential hot-water system in the world.



Convenient Logamatic Control

Adding a Buderus Logamatic control will give you the ultimate in comfort and fuel savings. Microprocessor-based controls allow the Logamatic to intelligently manage both your home heating and domestic hot water. The Logamatic has 16 standard functions including day/night setback, automatic summer/winter changeover and even a vacation mode. Set it once and relax in the comfort of your warm home.

G115WS Series

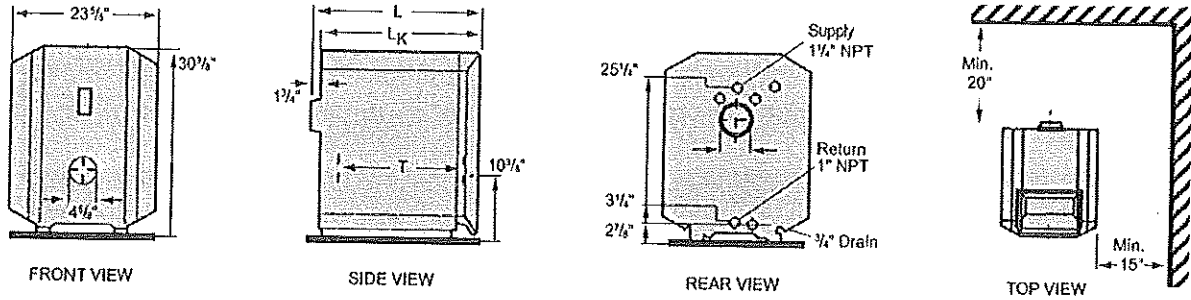

Model	G115WS/3		G115WS/4		G115WS/5	
Gross Output (BTU/Hr)	85,000	74,000	109,000	98,000	136,000	120,000
Net IBR (BTU/Hr)	74,000	64,000	95,000	85,000	119,000	104,000
Firing Rate (GPH)	0.70	0.60	0.90	0.80	1.10	1.0
AFLC	86.7%	86.5%	86.9%	86.8%	87%	86%
Vent Connection Size	5"		5"		5"	
Supply	1 1/4"		1 1/4"		1 1/4"	
Return	1"		1"		1"	
Number of Sections	3		4		5	
Overall Boiler Length (L)	23 1/2'		28 1/2'		33 1/2'	
Boiler Block Length (LK)	21 1/2'		25 1/2'		30 1/2'	
Minimum Boiler Width	18"		18"		18"	
Boiler Width	23 1/2"		23 1/2"		23 1/2"	
Minimum Boiler Height	33 1/2"		33 1/2"		33 1/2"	
Height	34 1/2"		34 1/2"		34 1/2"	
Boiler Feet Spacing	10 1/2"		16 1/2"		20 1/2"	
Fire Box Depth (T)	16"		20 1/2"		25 1/2"	
Fire Box Volume (cu. ft.)	1.20		1.75		2.21	
Dry Weight (lbs.)	330		403		476	
Water Content (gal.)	8.7		10.8		12.9	
Side	15"		15"		15"	
Back	20"		20"		20"	

The G115WS comes with B-Kit with Tridicator and Pressure Relief Valve.

The burner kits are available with oil burner control, flexible oil liner, circulator and flanges.



Approval numbers are subject to periodic changes and updates. Please visit www.buderus.us for the most up-to-date approval numbers.

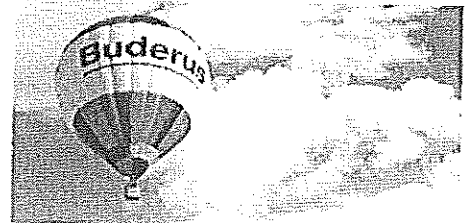

A Tradition of Excellence

The world leader in heating technologies since 1825, Buderus produced the first low-temperature hydronic heating systems. Today, Buderus products are acknowledged as the global standard in high-efficiency, low emissions hydronic heating. All Buderus products are designed to meet strict safety and environmental regulations.

Buderus boilers are quick and easy to install and will outlast and outperform virtually any other hot water heating system. They are designed for easy access and service. With appropriate maintenance, Buderus boilers deliver the highest efficiencies throughout the lifespan of operation. Buderus is a member of Bosch Thermotechnology

G115WS Direct Vent Installation Tips

ETL approved with two 4" 90° elbows, and up to 6' of 4" regular flue pipe for short vent runs. For longer runs, use up to 10' of flexible stainless steel insulated oil vent. Use 4" metal pipe for air intake. Use at least 6' to 8' of 4" metal pipe for air intake in conditioned space in cold climates (below -20°F). Direct vent burners are equipped with pre-and post-purge cycles for safe, complete exhaust of all combustion products, while cooling oil burner nozzle for positive shut-off. Buderus recommends the use of Beckett, Carlin and Riello burners. Please refer to the Buderus trade price list for models.

Front	Side	Back	Top	Galvanized Vent Pipe	Flex Insulated Oil Vent	AT-4 Exhaust Only Termination	PT-4 Concentric Termination
24"	6"	18"	6"	18"	1"	1"	1"

AT-4 Approved Termination

PT-4 Concentric Pipe-in-Pipe Termination

One of the two ETL certified terminations are required for use with G115WS series boilers for direct vent applications. Both terminations are "zero clearance" systems for easy versatile applications.