

DISPLAY THIS CARD ON PRINCIPAL FRONTAGE OF WORK



CITY OF PORTLAND

BUILDING PERMIT

This is to certify that

NORRIS INC.
PO BOX 2551 - 2257 WEST BROADWAY
SOUTH PORTLAND, ME 04106

For installation at

285 FOREST AVE
C-PORT CREDIT UNION

Job ID: 2011-10-2435-NEWCOM

CBL: 112- H-001-001

has permission to install supervised fire alarm system

provided that the person or persons, firm or corporation accepting this permit shall comply with all of the provisions of the Statutes of Maine and of the Ordinances of the City of Portland regulating the construction, maintenance and use of the buildings and structures, and of the application on file in the department.

Notification of inspection and written permission procured before this building or part thereof is lathed or otherwise closed-in. 48 HOUR NOTICE IS REQUIRED.

A final inspection must be completed by owner before this building or part thereof is occupied. If a certificate of occupancy is required, it must be

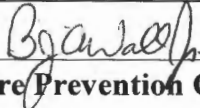
Fire Prevention Officer

(58)

Code Enforcement Officer / Plan Reviewer

THIS CARD MUST BE POSTED ON THE STREET SIDE OF THE PROPERTY
PENALTY FOR REMOVING THIS CARD

BUILDING PERMIT INSPECTION PROCEDURES

Please call 874-8703 or 874-8693 (ONLY)

or email: buildinginspections@portlandmaine.gov

With the issuance of this permit, the owner, builder or their designee is required to provide adequate notice to the city of Portland Inspections Services for the following inspections. Appointments must be requested 48 to 72 hours in advance of the required inspection. The inspection date will need to be confirmed by this office.

- **Please read the conditions of approval that is attached to this permit!! Contact this office if you have any questions.**
- **Permits expire in 6 months. If the project is not started or ceases for 6 months.**
- **If the inspection requirements are not followed as stated below additional fees may be incurred due to the issuance of a "Stop Work Order" and subsequent release to continue.**

Final Fire

The project cannot move to the next phase prior to the required inspection and approval to continue, REGARDLESS OF THE NOTICE OF CIRCUMSTANCES.

IF THE PERMIT REQUIRES A CERTIFICATE OF OCCUPANCY, IT MUST BE PAID FOR AND ISSUED TO THE OWNER OR DESIGNEE BEFORE THE SPACE MAY BE OCCUPIED.



PORTLAND MAINE

Strengthening a Remarkable City, Building a Community for Life • www.portlandmaine.gov

Director of Planning and Urban Development
Penny St. Louis

Job ID: 2011-10-2435-NEWCOM
install supervised fire alarm system

For installation at:
285 FOREST AVE
C-PORT CREDIT UNION

CBL: 112- H-001-001

Conditions of Approval:

Fire

The fire alarm system shall comply with the City of Portland Standard for Signaling Systems for the Protection of Life and Property. All fire alarm installation and servicing companies shall have a Certificate of Fitness from the Fire Department.

In field installation shall be installed per code as conditions dictate.

All smoke detectors and smoke alarms shall be photoelectric.

Records cabinet, FACP, annunciator(s), and pull stations shall be keyed alike.

Central Station monitoring for addressable fire alarm systems shall be by point.

All fire alarm records required by NFPA 72 should be stored in an approved cabinet located at the FACP labeled "FIRE ALARM RECORDS".

A 4100 series Knox Box is required.

The fire alarm system shall be certified by a master fire alarm company and have a new fire alarm inspection sticker.

System acceptance and commissioning must be coordinated with alarm and suppression system contractors and the Fire Department. Call 874-8703 to schedule.

Fire Alarm system shall be maintained. If system is to be off line over 4 hours a fire watch shall be in place. Dispatch notification required 874-8576.

A master box connection is not authorized for this building.

DRC

11-9-11

See Planning Conditions of Approval.

City of Portland, Maine - Building or Use Permit Application

389 Congress Street, 04101 Tel: (207) 874-8703, FAX: (207) 8716

Job No: 2011-10-2435-NEWCOM 2012-42420 FAFS	Date Applied: 04/04/2012	CBL: 112- H-001-001	
Location of Construction: 285 FOREST AVE	Owner Name: C-PORT CREDIT UNION	Owner Address: PO BOX 777, PORTLAND, ME 04101	Phone:
Business Name:	Contractor Name: SEABEE ELECTIC	Contractor Address: 84 PLEASANT HILL ROAD, SCARBOROUGH, ME 04074	Phone:
Lessee/Buyer's Name:	Phone:	Permit Type: FAFS - Fire Alarm	Zone: 883-5448
Past Use: Retail Bank and offices with drive-thru	Proposed Use: Same: Retail Bank and offices with drive-thru - To install fire alarm	Cost of Work: \$9,000.00	CEO District:
		Fire Dept: <input checked="" type="checkbox"/> Approved w/conditions <input type="checkbox"/> Denied <input type="checkbox"/> N/A	Inspection: Use Group: Type:
		Signature: <i>Bjorn [Signature]</i> (58)	Signature:
Proposed Project Description: Fire Alarm		Pedestrian Activities District (P.A.D.)	
Permit Taken By: Brad		Zoning Approval	

<p>1. This permit application does not preclude the Applicant(s) from meeting applicable State and Federal Rules.</p> <p>2. Building Permits do not include plumbing, septic or electrical work.</p> <p>3. Building permits are void if work is not started within six (6) months of the date of issuance. False informatin may invalidate a building permit and stop all work.</p>	<p>Special Zone or Reviews</p> <p><input type="checkbox"/> Shoreland</p> <p><input type="checkbox"/> Wetlands</p> <p><input type="checkbox"/> Flood Zone</p> <p><input type="checkbox"/> Subdivision</p> <p><input type="checkbox"/> Site Plan</p> <p>___ Maj ___ Min ___ MM</p> <p>Date: <i>OK - [Signature]</i> 4/4/12</p>	<p>Zoning Appeal</p> <p><input type="checkbox"/> Variance</p> <p><input type="checkbox"/> Miscellaneous</p> <p><input type="checkbox"/> Conditional Use</p> <p><input type="checkbox"/> Interpretation</p> <p><input type="checkbox"/> Approved</p> <p><input type="checkbox"/> Denied</p> <p>Date:</p>	<p>Historic Preservation</p> <p><input checked="" type="checkbox"/> Not in Dist or Landmark</p> <p><input type="checkbox"/> Does not Require Review</p> <p><input type="checkbox"/> Requires Review</p> <p><input type="checkbox"/> Approved</p> <p><input type="checkbox"/> Approved w/Conditions</p> <p><input type="checkbox"/> Denied</p> <p>Date: <i>[Signature]</i></p>
	CERTIFICATION		

I hereby certify that I am the owner of record of the named property, or that the proposed work is authorized by the owner of record and that I have been authorized by the owner to make this application as his authorized agent and I agree to conform to all applicable laws of this jurisdiction. In addition, if a permit for work described in the application is issued, I certify that the code official's authorized representative shall have the authority to enter all areas covered by such permit at any reasonable hour to enforce the provision of the code(s) applicable to such permit.

SIGNATURE OF APPLICANT	ADDRESS	DATE	PHONE
RESPONSIBLE PERSON IN CHARGE OF WORK, TITLE		DATE	PHONE



Fire Alarm Permit

If you or the property owner owes real estate or property taxes or user charges on any property within the city, payment arrangements must be made before permits of any kind are accepted.

Entered 4/2/12 (19)

2012-42420

ID #: 2011-10-2435 - New Can

B-2

Installation address: 285 Forest Ave. CBL: 112 H001

Exact location: (within structure) Main Entrance

Type of occupancy(s) (NFPA & ICC): Business

Building owner: C-Port Credit Union Box 797 - Portland 04101

System Designer (point of contact): Norris Inc-- Dave Gagnon

Designer phone: 883-3473 x1115 E-mail: daveg@norrisinc.com

Installing contractor: Seabee Electric Certificate of Fitness No: M1008

Contractor phone: 883-5448 E-mail: gener@seabeeelectric.com

This is a new application: YES NO New AES Master Box: YES NO
(Include Master Box approval form)

Amendment to an existing permit: YES NO Permit no: _____

The following documents shall be provided with this application:

- Floor plans
- Wiring diagram
- Annunciator details
- Input/ Output Matrix
- Equipment data sheets
- Electrical Permit Pulled (check alarm/com)
- Scope of Work
- 11 1/2 x 17s
- pdf copy (may be e-mailed)
- Designer qualifications
- Battery/ voltage drop calcs

Master box approval only: YES NO
(If yes check *New AES Master Box* above)

COST OF WORK: 9000.00

PERMIT FEE: 110.00
(\$10 PER \$1,000 + \$30 FOR THE FIRST \$1,000)

RECEIVED

APR 02 2012

Dept. of Building Inspections
City of Portland Maine

The designer shall be the responsible party for this application. Download a new copy of this application at www.portlandmaine.gov/fire for every submittal. Submit all plans in electronic PDF in addition to readable 11 1/2 x 17s to the Building Inspections Department, 389 Congress Street, Room 315, Portland, Maine 04101.

Prior to acceptance of any fire alarm system, a complete commissioning and acceptance test must be coordinated with all fire system contractors and the Fire Department, and proper documentation of such test(s) provided.

All installation(s) must comply with the *City of Portland Technical Standard for Signaling Systems for the Protection of Life and Property*, available at www.portlandmaine.gov/fire.

Applicant signature: Melissa Peters Date: 3/30/12



PORTLAND MAINE

Strengthening a Remarkable City, Building a Community for Life • www.portlandmaine.gov

Receipts Details:

Tender Information: Check , Check Number: 4553
Tender Amount: 110.00

Receipt Header:

Cashier Id: bsaucier
Receipt Date: 4/2/2012
Receipt Number: 42421

Receipt Details:

Referance ID:	5903	Fee Type:	UI-MI
Receipt Number:	0	Payment Date:	
Transaction Amount:	110.00	Charge Amount:	110.00
Job ID: Job ID: 2011-10-2435-NEWCOM - New CPort Credit Union 3,815 sq ft			
Additional Comments: 285 Forest			

Thank You for your Payment!

Master Box Approval

Applicant: Norris Inc.
App Phone #: 883-3473
Building Name: C-Port Credit Union
Building Address: 285 Forest Ave.
Portland, ME. 04101

Emergency Contact: Gene Ardito
Emergency phone #: 712-9146
Date of Application: 3/30/12
Billing Address: same

Occupancy: _____
Assembly OL>300, 20 unit apartment building, etc.

Comments: _____

Applicant completes above and submits with Fire Alarm Permit

1

FIRE PREVENTION: Approved Denied

_____/_____/_____
Date

Fire Prevention Officer

Zone 1: _____ Zone 2: City disconnect Zone 3: _____
Zone 4: _____ Zone 5: _____ Zone 6: _____
Zone 7: _____ Zone 8: AES Tamper switch

Modify City Box response to alarm sounding in CAD

2

FIRE ALARM: Box #: _____

ELECTRICAL DIVISION: Approved Denied

Box Type: AES Radio Box /
New Other

3

Test Date: _____ In Service Date: 2/1/12 _____
Fire Alarm Technician

AES

Circuit if applicable: _____

4

FIRE ALARM: Same Running Assignment As Box: _____

Notifications: All Stations Run Books Digitizer Computer Cad Box Test

South Portland _____
Other Dispatcher

5

BILLING: Entered _____
Financial Officer



PO Box 2551
2257 West Broadway
South Portland, ME 04106

1.800.370.3473
fax 207.879.0540

www.norrisinc.com

3/30/12

Scope of Work: C-Port Credit Union

Seabee Electric to install new addressable fire alarm system. Norris Inc. to install master box, provide fire alarm equipment, submittal documents, program and test per City of Portland requirements.



PO Box 2551
2257 West Broadway
South Portland, ME 04106

1.800.370.3473
fax 207.879.0540

www.norrisinc.com

SUBMITTAL PACKAGE

Project: C-Port Credit Union, Portland

System: Fire Alarm Systems

**Submitted
By:** Norris Inc.
2257 West Broadway
South Portland, Maine 04106
Telephone: (800) 370-3473

**Electrical
Contractor:** Seabee Electric
84 Pleasant Hill Road
Scarborough, ME. 04074

Date: February 7, 2012



PO Box 2551
2257 West Broadway
South Portland, ME 04106

1.800.370.3473
fax 207.879.0540

www.norrisinc.com

Company Profile

"We are extremely proud to represent the highest quality manufacturers integrating life safety, alarm and communication systems throughout northern New England."

-- Bradford Norris, President --

Mission Statement

Provide quality engineered systems, exceptional service.

Goal

Learn...Continually Improve...Exceed Expectations

Founded in 1979 Norris Inc. has grown to become Northern New England's leading integrated system contracting and supply company. Norris Inc. is an innovated proactive organization with extensive experience in integration interdisciplinary building management systems. Our local and national affiliations assure that your project will be done properly regardless of size representing leading manufacturers our comprehensive products provide outstanding quality reliability and performance... surpassing customer application requirements and exceeding the stringent requirements of Underwriters Laboratories, National Fire Protection Association and other codes. We maintain an exceptional level of quality and provide the highest levels of customer service. Our knowledgeable technical support will insure the great service you deserve. Whether your needs involve industrial, commercial, institutional, or educational applications, you can trust that Norris Inc. has the complete resources it takes to provide the right solution right away.



PO Box 2551
2257 West Broadway
South Portland, ME 04106

1.800.370.3473
fax 207.879.0540

www.norrisinc.com

LIMITED WARRANTY

Norris, Inc. warrants that the products of its manufacturers shall be free from defects in materials or workmanship as warranted by the manufacturer which is typically for a one (1) year period from the completed installation date, but not always. The completed installation date will be the date when the end-user was able to begin using or started using the product(s) or the system, whether partially or in its entirety. For projects that have a specification or bid instructions to follow which contains specific warranty requirements, Norris Inc. will always honor the warranty terms exactly as specified in the project's specifications or bid documents, which may be more or less in coverage and duration than the manufacturer's warranty. In performing hundreds of projects per year with thousands of different products it is impossible for Norris, Inc. to track the terms and details of specified or individual product warranties. Therefore Norris, Inc. will request that the owner's representative provide these special warranty details when the warranty work is requested; otherwise a standard one year warranty on the equipment will be honored. The manufacturer's warranty is for equipment only and does not include any labor and/or shipping costs. All warranties provided by Norris, Inc. are limited with the same limitations included with the manufacturer's warranty which is included in the manuals of the products being provided.

The warranty will apply only if such goods have been properly installed, are subject to normal proper use and have not been modified in any manner whatsoever. Upon return of the defective product, Norris, Inc. will, at its sole discretion, either repair or replace, at no cost, such goods determined to have a defect in materials or workmanship. In cases of a warranty repair, Norris, Inc. will use its sole discretion to determine if a suitable replacement part can be provided on loan while the repairs are being performed.

All warranty work is performed during regular business hours. If emergency warranty work is required, the customer will pay the difference between the emergency service bill and our normal hourly charges.

Norris, Inc.'s limited warranty does not apply to those products that are damaged due to misuse, abuse, negligence, exposure to adverse environmental conditions, acts of God or have been modified in any manner whatsoever.

Norris, Inc.'s Standard terms and conditions are provided with our invoices. Those Terms and Conditions shall be provided upon request.

NORRIS, INC. SHALL NOT UNDER ANY CIRCUMSTANCES BE LIABLE FOR ANY INCIDENTAL OR CONSEQUENTIAL DAMAGES ARISING FROM LOSS OF LIFE &/OR PROPERTY OR OTHER DAMAGE OR LOSSES OWING TO THE FAILURE OF NORRIS INC. PRODUCTS BEYOND THE COST OF REPAIR OR REPLACEMENT OF ANY DEFECTIVE PRODUCTS.

NORRIS, INC. MAKES NO WARRANTY OF FITNESS OR MERCHANTABILITY AND NO OTHER WARRANTY, ORAL OR WRITTEN, EXPRESS OR IMPLIED AS ALLOWED TO THE FULLEST EXTENT OF THE LAW.



This is to certify that

NORRIS, INC.

is an authorized Engineered Systems Distributor for NOTIFIER

During the year of 2011



Vice President Domestic Sales

Signed for and on behalf of NOTIFIER



CERTIFICATE *of* MEMBERSHIP

Norris Inc

is a member in good standing entitled to all rights and privileges of membership and subject to all conditions and objectives as defined in the association bylaws, code of ethics and standards of conduct.

A handwritten signature in black ink, appearing to read "Merlin J. Guilbeau".

MERLIN J. GUILBEAU
EXECUTIVE DIRECTOR

A handwritten signature in black ink, appearing to read "Charles W. D'Ascoli".

CHARLES "DOM" D'ASCOLI
PRESIDENT

2011

This
Certificate of Fitness

MASTER
Fire Alarm Installation and Servicing Company

is awarded to

NORRIS INC.

PO Box 2551 – 2257 West Broadway
S. Portland, ME 04106
(207)883-3473

CF # **M1008**



B. J. Walsh

12/31/2011

Authority Having Jurisdiction

Expiration Date

**THIS CERTIFICATE IS NOT AN ENDORSEMENT OF THIS COMPANY BY THE
AUTHORITY HAVING JURISDICTION.**

**TERMS AND CONDITIONS OF THIS CERTIFICATE OF FITNESS SHALL BE AS
FOLLOWS:**

**THIS CERTIFICATE REMAINS THE PROPERTY OF THE PORTLAND FIRE
DEPARTMENT AND SHALL BE RETURNED UPON DEMAND;**

THIS CERTIFICATE OF FITNESS IS NON-TRANSFERABLE;

**THIS CERTIFICATE OF FITNESS SHALL REMAIN IN EFFECT IN SO FAR AS THE
BEARER OF SAID INSTRUMENT SHALL COMPLY WITH RULES AND
REGULATIONS ESTABLISHED BY THE AUTHORITY HAVING JURISDICTION.**

**FAILURE TO COMPLY WITH ALL RULES AND REGULATIONS OF THE
AUTHORITY HAVING JURISDICTION WILL RESULT IN THE FOLLOWING:**

FIRST OFFENCE: PLAN OF ACTION TO ADDRESS DEFICIENCIES

SECOND OFFENCE: PROBATION OF SERVICE COMPANY

THIRD OFFENCE: TERMINATION OF CERTIFICATE OF FITNESS



National Independent Fire Alarm Distributors Association

This is to Certify that

Morris Inc.

is a

Member in Good Standing

and is entitled to all rights and privileges of such membership

David Palmer

Secretary

Bob Smith

President

City of Portland/Portland Police Department
Alarm Business/Agent Permit

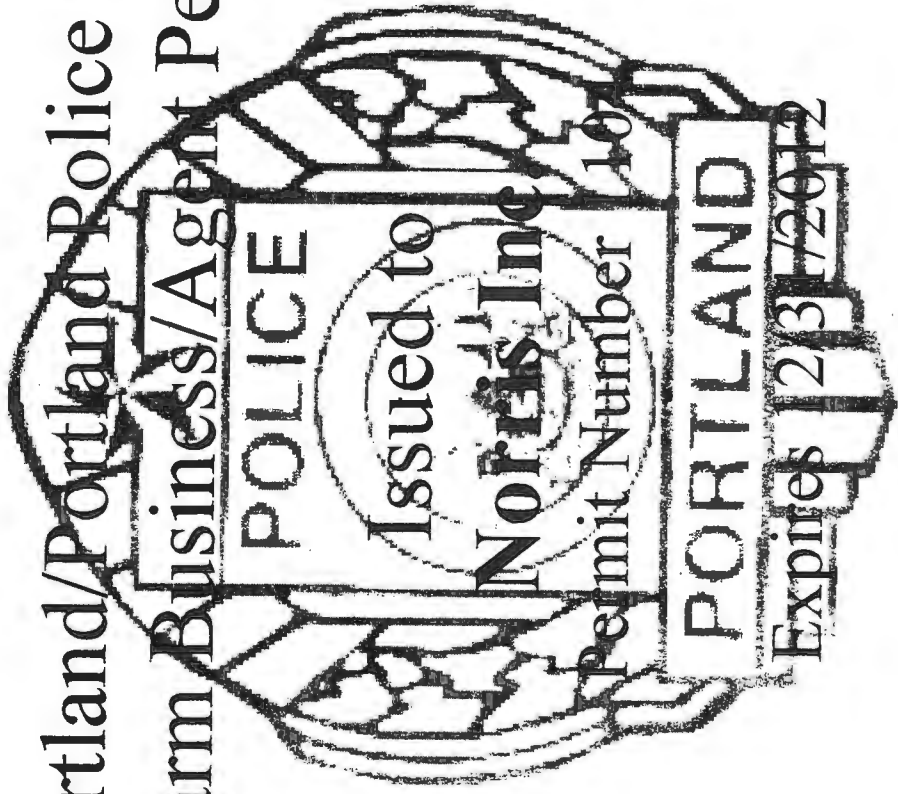

NATIONAL SYSTEMS CONTRACTORS ASSOCIATION

NSCA Membership Certificate

This is to certify that

Norris Inc

is an official member of the

National Systems Contractors Association

on this the

First of December

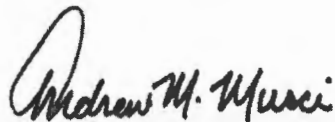

Andrew M. Musci
President



Chuck Wilson
Executive Director



**NATIONAL INSTITUTE FOR CERTIFICATION
IN ENGINEERING TECHNOLOGIES®**

Providing Certification Programs Since 1961

BE IT KNOWN THAT

David S. Gagnon

IS HEREBY AWARDED CERTIFICATION AT

LEVEL IV

**IN FIRE PROTECTION ENGINEERING TECHNOLOGY
FIRE ALARM SYSTEMS**

BASED UPON SUCCESSFUL DEMONSTRATION OF REQUISITE KNOWLEDGE,
EXPERIENCE AND WORK PERFORMANCE AS SET FORTH BY THIS INSTITUTE.

Certification Valid through April 1, 2014

CERTIFICATION NUMBER 88203

CHAIRMAN OF THE NICET BOARD OF GOVERNORS

A DIVISION OF THE NATIONAL SOCIETY OF PROFESSIONAL ENGINEERS

Norris Inc

2257 West Broadway
South Portland, ME 04106
1-800-370-3473

SEABEE ELECTRIC

84 PLEASANT HILL RD
SCARBOROUGH, ME 04074

311041SP**Equipment List : Status: 4 Submittals**

Page: 1

SEABEE 207-883-5448 Fax:883-1660

C-Port Credit Union, Portland**Description**

NOTIFIER-NFW-50, Addressable Fire Alarm Control Panel, Black
ADI-IM-1270, 12V 7AH Battery
ADI-MO-804R2, MOD TO MOD 8C 2'RADIONICS CORD
ADI-MO-RJ31X, SFS MT 8C RJ31X UL (917UL)
NOTIFIER-NOT-BG12LX, Addressable Pull Station
NOTIFIER-NP-100, Intelligent Addressable Photo detector, with base.
NOTIFIER-NH-100, Intelligent Addressable Thermal detector w/ base.
NOTIFIER-NMM-100P, Addressable Mini Module (sprinkler)
NOTIFIER-HSR, Horn Strobe, Red, Wall, 2 wire, 12/24V, multi-candela
NOTIFIER-HSRC, Horn Strobe, Red, Ceiling, 2 wire, 12/24V, multi-candela
NOTIFIER-STR, Strobe, Red, Wall, 2 wire, 12/24V, multi-candela
AES-7750-F8 RED, 8 Zone Fire Subscriber, 8 Supervised Zones,
ADI-IM-1270, 12V 7AH Battery
ADI-AS-XF1640Y, Transformer 16VAC 40VA
NOTIFIER-NC-100R, Addressable Relay Module (masterbox)
NOTIFIER-NMM-100, Addressable Monitor Module (masterbox)
ADI-GI-TSW01, Tamper Box w/ Shunt
Disconnect Switch
SPECIAL-KNOXR, Knox Box (4100 Series)
SPECIAL-KNOXR-SURFACE, Surface Mount Knox Box
SPECIAL-KNOXR-LIFTCOVER, Lift Cover for Knox Box
SPECIAL-KNOXR-BLACK, Black Knox Box Color

→ FireWarden-50(E)

Intelligent Addressable FACP with Built-In Communicator

NOTIFIER[®]
by Honeywell

Addressable Fire Alarm Control Panels

General

The NOTIFIER FireWarden-50 (NFW-50) is a Fire Alarm Control Panel (FACP) and Digital Alarm Communicator/Transmitter (DACT) combined into one circuit board. This compact, intelligent addressable control panel supports up to 50 addressable devices in any combination of detectors or modules. With an extensive list of powerful features, the FireWarden-50 programs just like FireWarden-100 products, yet fits into applications previously served only by conventional panels.

The FireWarden-50's integral DACT transmits system status (alarms, troubles, AC loss, etc.) to a Central Station via the public switched telephone network. It also allows remote and local programming of the control panel using the VFWARDEN-CD Upload/Download utility. In addition, the control panel may be programmed or interrogated off-site via the public switched telephone network. Any personal computer with Windows™ 95 or greater, and compatible modem with a speed of 14.4 kbps or faster and Upload/Download software kit VFWARDEN-CD, may serve as a Service Terminal. This allows download of the entire program or upload of the entire program, history file, walktest data, current status and system voltages.

The power supply and all electronics are contained on a single circuit board supported on a new quick install chassis and housed in a metal cabinet. Available accessories include local and remote upload/download software, remote annunciators, and reverse polarity/city box transmitter. (4XTM)

The FireWatch Series internet monitoring modules IPDACT-2 and IPDACT-2UD permit monitoring of alarm signals over the Internet saving the monthly cost of two telephone lines. Although not required, the secondary telephone line may be retained providing backup communication over the public switched telephone line.

NOTE: Unless otherwise specified, the term FireWarden-50 is used in this data sheet to refer to both the FireWarden-50 and the FireWarden-50E FACPs. For FireWarden-50C, refer to DN-60446.

Features

- Listed to UL Standard 864, 9th edition.
- Auto-program (learn mode) reduces installation time. Reports two devices set to the same address.
- On-board DACT.
- Two independently programmable Style Z (Class A) or Style Y (Class B) NAC circuits.
- Selectable strobe synchronization for System Sensor, Wheelock, and Gentex devices.
- Remote Acknowledge, Silence, Reset and Drill via addressable monitor modules.
- Two programmable relays and one fixed trouble relay.
- Built-in Programmer.
- Telephone Line Active LEDs.
- EIA-232 PC interface.
- Integral 80-character LCD display with backlighting.
- Real-time clock/calendar with automatic daylight savings control.
- History file with 500 event capacity.
- Automatic detector sensitivity testing (NFPA 72 compliant).
- Automatic device type-code verification.
- Point trouble identification.

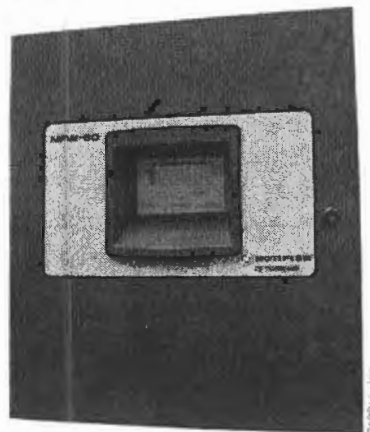

- Waterflow selection per module point.
- Alarm verification selection per detector point.
- Maintenance alert warns when smoke detector dust accumulation is excessive.
- One-person audible or silent walk test with walk-test log and printout.
- System alarm verification selection per detector point.
- PAS (Positive Alarm Sequence) and Pre-signal per point (NFPA 72 compliant).
- Up to eight ANN-BUS annunciators.
- Remote Acknowledge, Alarm Silence, Reset and Drill via addressable modules or remote annunciator.
- Upload/Download (local or remote) of program and data via integral DACT.

SLC COMMUNICATION LOOP

- Single addressable SLC loop which meets NFPA Style 4, 6 and 7 requirements.
- 50 addressable device capacity (any combination of addressable detectors and modules).
- Compatible with NOTIFIER FireWarden addressable devices (refer to the *FireWarden SLC Wiring Manual*).

NOTIFICATION APPLIANCE CIRCUITS (NACS)

- Two independently programmable output circuits. Circuits can be configured for the following outputs:
 - Style Y (Class B)
 - Style Z (Class A)
 - Door Holder Service (cannot be used for notification appliances)
 - Aux Power Source (cannot be used for notification appliances)
- Silence Inhibit and Autosilence timer options.
- Continuous, March Time, Temporal or California code for main circuit board NACs with two-stage capability.
- Selectable strobe synchronization per NAC.
- 2.5 A total power for NACs.

NOTE: Maximum or total 24VDC system power shared between all NAC circuits and the ANN-BUS is 2.7 A.

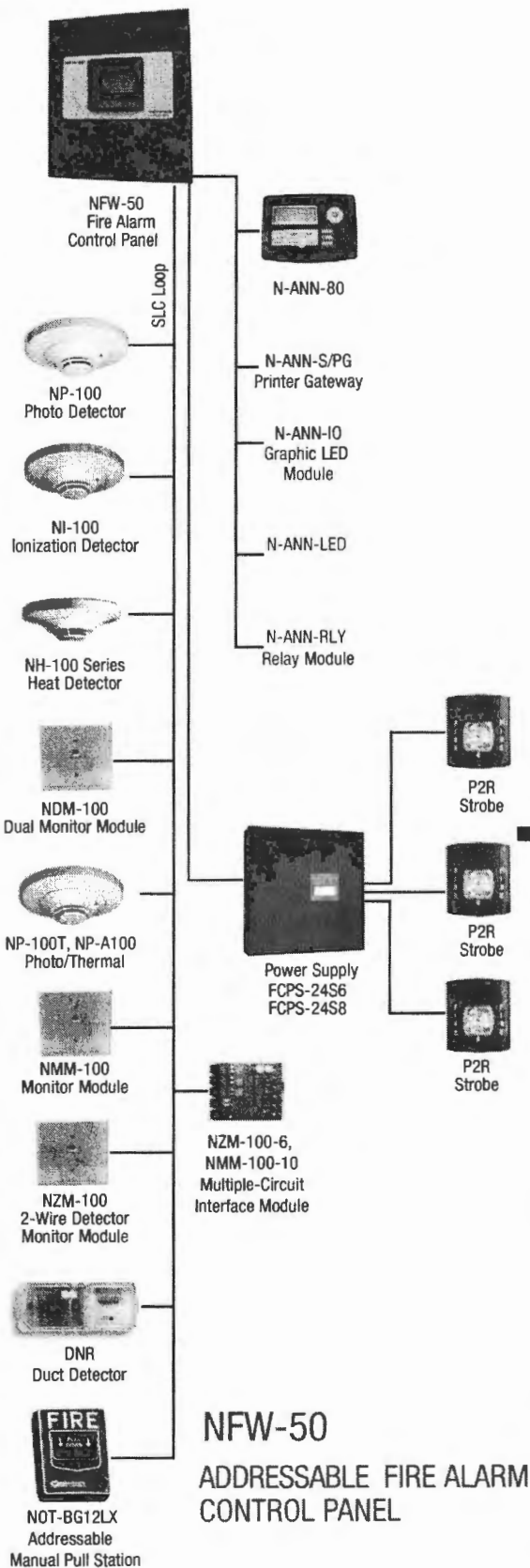

PROGRAMMING AND SOFTWARE

- Autoprogram (learn mode) reduces installation time.
- Custom English labels (per point) may be manually entered or selected from an internal library file.
- Two programmable Form-C relay outputs.
- 20 software zones.
- Continuous fire protection during online programming at the front panel.
- Program Check automatically catches common errors not linked to any zone or input point.
- **OFFLINE PROGRAMMING:** Create the entire program in your office using a Windows®-based software package (order programming kit VFWARDEN-CD separately). Upload/download system programming locally.

User interface

LED INDICATORS

- AC Power (green)
- Fire Alarm (red)
- Supervisory (yellow)
- Trouble (yellow)
- Alarm Silenced signals (yellow)

KEYPAD

- 16 key alpha-numeric pad
- Acknowledge/Step
- Alarm Silenced
- Drill (Manual Evacuate)
- Reset (lamp test)

Product Line Information

NFW-50: Combination DACT/Fire Alarm Control Panel with one SLC loop. Includes main circuit board with display, chassis with transformer, backbox with door, plastic bag containing screws, cables, key, etc., manual. (For NFW-50C, refer to DN-60446.)

NFW-50E: Same as NFW-50, but operates at 240 VAC.

NFW-50R: Same as NFW-50, with red backbox and door.

VFWARDEN-CD: Programming software for Windows®-based PC computer (cable not included).

DP-51050B: Optional dress panel for NFW-50 (black).

DP-51050: Optional dress panel for the NFW-50R (red).

TR-CE-B: Optional trim ring for semi-flush mounting. (Black. For red, order TR-CE.)

BB-XP: Optional cabinet for one or two modules.

BB-25: Optional cabinet for up to six modules mounted on CHS-6 chassis.

BB-26: Battery backbox, holds up to two 25 AH batteries and CHG-75.

NFS-LBB: Battery box, houses two 55 AH batteries

CHS-6: Chassis, mounts up to six multi-modules in a BB-25 cabinet.

CHG-75: Battery charger for lead-acid batteries with a rating of 25 to 75 AH.

CHG-120: Remote battery charging system for lead-acid batteries with a rating of 55 to 120 AH. Requires additional NFS-LBB for mounting.

NOTE: CHG-120 or CHG-75 required for batteries larger than 18AH.

- **BAT Series:** Batteries, see data sheet DN-6933.
- PRT/PK-CABLE:** Cable printer/personal computer interface cable.
- PRN-6:** UL listed compatible event printer. Uses tractor-fed paper.
- IPDACT, IPDACT-2/2UD Internet Monitoring Module:** Mounts in bottom of enclosure with optional mounting kit (PN IPBRKT). Connects to primary and secondary DACT telephone output ports for internet communications over customer provided ethernet internet connection. Requires compatible Teldat Visoralarm Central Station Receiver. Can use DHCP or static IP. (See data sheet dn-60408 for more information.)
- IPBRKT:** Mounting kit for IPDACT-2/2UD in common enclosure.
- IPSPLT:** Y-adaptor option allows connection of both panel dialer outputs to one IPDACT-2/2UD cable input.
- AC-TRMBLK:** AC Terminal Block mounts to a metal bracket, in turn, mounts to the FACP chassis. Use AC-TRMBLK when wire nuts are not allowed for AC connections to the transformer.

OPTIONAL MODULES

4XTM Reverse Polarity Transmitter Module: Provides a supervised output for local energy municipal box transmitter, alarm and trouble. Includes a disable switch and disable trouble LED.

COMPATIBLE ANNUNCIATORS

N-ANN-80(-W): Remote LCD annunciator mimics the information displayed on the FACP LCD display. Recommended wire type is un-shielded. (Basic model is black; order -W for white; see DN-7114.)

N-ANN-I/O: LED Driver Module provides connections to a user supplied graphic annunciator. (See DN-7105.)

N-ANN-LED: Annunciator Module provides three LEDs for each zone: Alarm, Trouble, and Supervisory. Ships with red enclosure. (See DN-60242.)

N-ANN-RLED: Provides alarm (red) indicators for up to 30 input zones or addressable points. (See DN-60242.)

N-ANN-RLY: Relay Module provides 10 programmable Form-C relays. Can be mounted inside the cabinet. (See DN-7107.)

N-ANN-S/PG: Serial/Parallel Printer Printer Gateway module provides a connection for a serial or parallel printer. (See DN-7103.)

ADDRESSABLE DEVICES

All feature a polling LED and rotary switches for addressing.

NI-100: Addressable low-profile ionization smoke detector.

NP-100: Addressable low-profile photoelectric smoke detector.

NP-100T: Addressable low-profile photoelectric smoke detector with thermal sensor.

NP-100R: Remote test capable addressable photoelectric smoke detector for use with DNR(W) duct detector housing.

NH-100: Fast-response, low-profile heat detector.

NH-100R: Fast-response, low-profile heat detector with rate-of-rise option.

NH-100H: Fast-response, low-profile heat detector that activates at 190°F/88°C.

NP-A100: Addressable low-profile multi-sensor detector.

DNR: InnovairFlex low-flow non-relay duct-detector housing. (Order NP-100R separately.)

DNRW: InnovairFlex low-flow non-relay duct-detector housing, with NEMA-4 rating. Watertight. (Order NP-100R separately.)

NMM-100: Addressable Monitor Module for one zone of normally-open dry-contact initiating devices. Mounts in standard 4.0" (10.16 cm.) box. Includes plastic cover plate and end-of-line resistor. Module may be configured for either a Style B (Class B) or Style D (Class A) IDC.

NDM-100: Dual Monitor Module. Same as NMM-100 except it provides two Style B (Class B) only IDCs.

NMM-100P: Miniature version of NMM-100. Excludes LED and Style D option. Connects with wire pigtailed. May mount in device backbox.

NZM-100A: Similar to NMM-100A. Addressable Monitor Module for one zone of conventional two-wire detectors. Requires resettable 24 VDC power. Refer to the *Device Compatibility Document* for listed compatible devices and quantity limitation.

NZM-100-6: Six-zone interface module. Mount one or two modules in a BB-XP cabinet (optional). Mount up to six modules on a CHS-6 chassis in a BB-25 cabinet.

NMM-100-10: Ten-input monitor module. Mount one or two modules in a BB-2 cabinet (optional). Mount up to six modules on a CHS-6 chassis in a BB-25 cabinet.

NC-100: Addressable Control Module for one Style Y/Z (Class B/A) zone of supervised polarized Notification Appliances. Mounts directly to a 4.0" (10.16 cm.) electrical box. Notification Appliance Circuit option requires external 24 VDC to power notification appliances.

NC-100R: Addressable relay module containing two isolated sets of Form-C contacts, which operate as a DPDT switch. Mounts directly to a 4.0" (10.16 cm.) box, surface mount using the SMB500.

NOT-BG12LX: Addressable manual pull station with interface module mounted inside.

N100-ISO: Fault Isolator Module.

SMB500: Used to mount all modules except the NMM-100P.

NOTE: For more information on Compatible Addressable Devices for use with the FireWarden-50, see the following data sheets (document numbers): N100-ISO (DN-6994), NP-100 series (DN-6995), NI-100 (DN-6996), NH-100/NH-100R (DN-6997), DNR/InnovairFlex (DN-60424, DN-60429), ND-100/ND-100R (DN-7006), NP-A100 (DN-6998), NMM-100/NMM-100P/NDM-100/NZM-100 (DN-6999), NC-100 (DN-7000), NC-100R (DN-60383), NMM-100-10 (DN-6990), and NOT-BG12LX (DN-7001).

ADDRESSABLE DEVICE ACCESSORIES

End-of-Line Resistor Assembly (R-47K and R-3.9K): 47k ohm supervises the NMM-100-10, NDM-100, NMM-100P, and NC-100 module circuits. 3.9k ohm End-of-Line Resistor assembly supervises the NZM-100-6 module circuit. These resistors are included with each module.

Power Supervision Relay: Supervises the power to 4-wire smoke detectors and notification appliances.

Wiring Requirements

While shielded wire is not required, it is recommended that all SLC wiring be twisted-pair to minimize the effects of electrical interference. Refer to the panel manual for wiring details.

SYSTEM SPECIFICATIONS

System Capacity

- Intelligent Signalling Line Circuits..... 1
- Addressable device capacity 50
- Programmable software zones 20
- Annunciators 8

Electrical Specifications

AC Power: FireWarden-50: 120 VAC, 60 Hz, 3.0 A. FireWarden-50E: 240 VAC, 50 Hz, 1.5 A. Wire size: minimum 14 AWG (2.00 mm²) with 600 V insulation. Nonpower-limited, supervised.

Battery: Two 12 V 18 AH lead-acid batteries. Battery Charger Capacity: 7-18 AH (FireWarden-50 cabinet holds maximum of two 18 AH batteries.)

Communication Loop: Supervised and power-limited.

Notification Appliance Circuits: Terminal Block provides connections for two NACs, Style Y (Class B) or. Style Z (Class A). Special Application power. Power-limited, supervised circuitry. Maximum signaling current per circuit: 2.5 A. End-of-Line Resistor: 4.7 kohm, ½ watt (P/N 71252 UL listed) for Style Y (Class B) NAC. Refer to the *NOTIFIER Device Compatibility Document* for listed compatible devices.

Two Programmable Relays and One Fixed Trouble Relay: Contact rating: 2.0 A @ 30 VDC (resistive), 0.5 A @ 30 VAC (resistive). Form-C relays, nonpower-limited, nonsupervised.

Cabinet Specifications

Door: 19.26" (48.92 cm.) high x 16.82" (42.73 cm.) wide x 0.72" (1.82 cm.) deep. **Backbox:** 19.00" (48.26 cm.) high x 16.65" (42.29 cm.) wide x 5.25" (13.34 cm.) deep. **Trim Ring (TR-CE/B):** 22.00" (55.88 cm.) high x 19.65" (49.91 cm.) wide.

Shipping Specifications

Weight: 26.9 lbs. (12.20 kg.) **Dimensions:** 20.00" (50.80 cm.) high x 22.5" (57.15 cm.) wide x 8.5" (21.59 cm.) deep.

Temperature and Humidity Ranges

This system meets NFPA requirements for operation at 0 – 49°C/32 – 120°F and at a relative humidity 93% ± 2% RH

(noncondensing) at 32°C ± 2°C (90°F ± 3°F). However, the useful life of the system's standby batteries and the electronic components may be adversely affected by extreme temperature ranges and humidity. Therefore, it is recommended that this system and its peripherals be installed in an environment with a normal room temperature of 15 – 27°C/60 – 80°F.

NFPA Standards

The FireWarden-50 complies with the following NFPA 72 Fire Alarm Systems requirements:

- **LOCAL** (Automatic, Manual, Waterflow and Sprinkler Supervisory).
- **AUXILIARY** (Automatic, Manual and Waterflow) (requires 4XTM).
- **REMOTE STATION** (Automatic, Manual and Waterflow) (Where a DACT is not accepted, the alarm, trouble and supervisory relays may be connected to UL 864 listed transmitters. For reverse polarity signaling of alarm and trouble, 4XTM is required.)
- **PROPRIETARY** (Automatic, Manual and Waterflow).
- **CENTRAL STATION** (Automatic, Manual and Waterflow, and Sprinkler Supervised).
- **OT, PSDN** (Other Technologies, Packet-switched Data Network)

Agency Listings and Approvals

The listings and approvals below apply to the basic FireWarden-50 control panel. In some cases, certain modules may not be listed by certain approval agencies, or listing may be in process. Consult factory for latest listing status.

- **UL:** S635
- **FM approved**
- **CSFM:** 7165-0028:239
- **MEA:** 442-06-E Vol. 2

NOTE: See DN-60446 for ULC-listed model.

NOTIFIER®, FireWarden®, and System Sensor® are registered trademarks of Honeywell International Inc. Microsoft® and Windows® are registered trademarks of the Microsoft Corporation. ©2010 by Honeywell International Inc. All rights reserved. Unauthorized use of this document is strictly prohibited.



This document is not intended to be used for installation purposes.
We try to keep our product information up-to-date and accurate.
We cannot cover all specific applications or anticipate all requirements.
All specifications are subject to change without notice.



Made in the U.S. A.

For more information, contact Notifier. Phone: (203) 484-7161, FAX: (203) 484-7118.
www.notifier.com

➔ BAT Series Batteries

Sealed Lead-Acid or Gell Cell

 **NOTIFIER**[®]
by Honeywell

Power Supplies

General

BAT Series Batteries feature a new part-numbering/listing system — providing an improved method of delivery for NOTIFIER-approved sealed lead-acid batteries for all your fire alarm system needs. Multiple brands of batteries are now offered under generic part numbers, reducing backorder situations and permitting us to deliver these products in a more timely fashion. NOTIFIER has approved the multiple brands listed below as possible product shipped for a given part number. Please note that any incoming orders for "PS Series" batteries will be converted to the equivalent BAT Series part numbers.

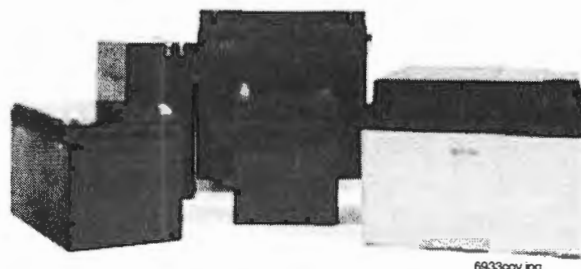

Features

- Provide secondary power for control panels.
- Sealed and maintenance-free.
- Overcharge protected.
- Easy handling with leakproof construction.
- Ruggedly constructed, high-impact case (ABS, polystyrene, or polypropylene, depending on models).
- Long service life.
- Compact design.

Agency Listings and Approvals

The listings and approvals below apply to BAT Series Batteries. In some cases, certain modules may not be listed by certain approval agencies, or listing may be in process. Consult factory for latest listing status.

- **UL Recognized Components:** files MH19884 (*B & B Battery*), MH20567 (*UPG, previously Jolt*), MH20845 (*Power-Sonic*).

Part Number Reference

CURRENT Part Number	BATTERY DESCRIPTION	ALTERNATES APPROVED: manufacturers and P/Ns shipped under BAT P/Ns
BAT-1250	12 V, 5 AH, sealed.	BP5-12 (B&B Battery); PS-1250 (Power-Sonic); SA1250 (Jolt) to be replaced with UB1250 (UPG).
BAT-1250	12 V, 5 AH, sealed.	BP5-12 (B&B Battery); PS-1250 (Power-Sonic); SA1250 (Jolt) to be replaced with UB1250 (UPG).
➔ BAT-1270	12 V, 7 AH, sealed.	BP7-12 (B&B Battery); PS-1270 (Power-Sonic); SA1272 (Jolt) to be replaced with UB1270 (UPG).
BAT-12120	12 V, 12 AH, sealed.	BP12-12 (B&B Battery); PS-12120 (Power-Sonic); SA12120 (Jolt) to be replaced with UB12120 (UPG).
BAT-12180	12 V, 18 AH, sealed.	PS-12180 (Power-Sonic); SA12180 (Jolt) to be replaced with UB12180 (UPG).
BAT-12180	12 V, 18 AH, sealed.	PS-12180 (Power-Sonic); SA12180 (Jolt) to be replaced with UB12180 (UPG).
BAT-12260	12 V, 26 AH, sealed.	BP26-12 (B&B Battery); PS-12260 (Power-Sonic); SA12260 (Jolt) to be replaced with UB12260 (UPG).
BAT-12550	12 V, 55 AH, sealed.	PS-12550 (Power-Sonic); XSA12550 (Jolt) to be replaced with UB12550 (UPG).
BAT-12550	12 V, 55 AH, sealed.	PS-12550 (Power-Sonic); XSA12550 (Jolt) to be replaced with UB12550 (UPG).
BAT-121000	12 V, 100 AH, gell cell.	PS-121000 (Power-Sonic); XSA121000A (Jolt) to be replaced with UB121000 (UPG).

POWER-SONIC

Part Number Reference

1109t1.tbl

MODEL	Nominal Voltage V	Nominal Capacity @ 20 hr. rate A.H.	Discharge Current @ 20 hr. rate mA	DIMENSIONS									
				Width		Depth		Height		Height over terminal		Weight	
				in.	mm	in.	mm	in.	mm	in.	mm	lb.	kg.
PS-1250	12	5	250	3.54	90	2.76	70	4.02	102	4.21	107	4.1	1.9
PS-1270	12	7	325	5.94	151	2.56	65	3.7	94	3.86	98	5.7	2.6
PS-12120	12	12	600	5.94	151	3.86	98	3.7	94	3.86	98	8.8	4
PS-12180	12	18	875	7.13	181	2.99	76	6.57	167	6.57	167	12.8	5.8
PS-12250	12	25	1300	6.89	175	6.54	166	4.92	125	4.92	125	18.7	8.5
PS-12550	12	55	3000	10.25	260	6.6	168	8.2	208	9.45	240	39.7	18
PS-121000	12	100	5000	12	305	6.6	168	8.2	208	9.45	240	65.7	29.8

Characteristic Discharge Curves

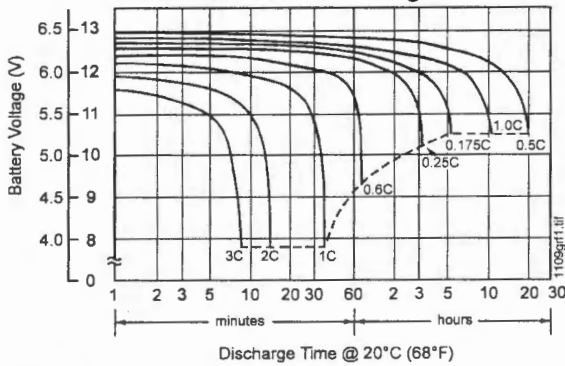

Effect of Temperature on Capacity

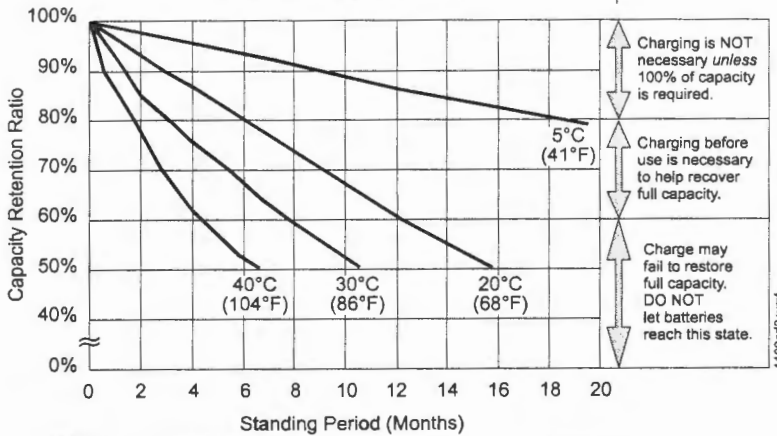
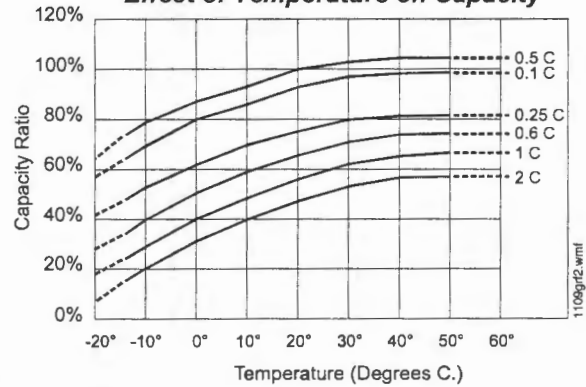

at left:
PS-121000
Shelf-Life
and Storage

Charging is NOT necessary unless 100% of capacity is required.

Charging before use is necessary to help recover full capacity.

Charge may fail to restore full capacity. DO NOT let batteries reach this state.

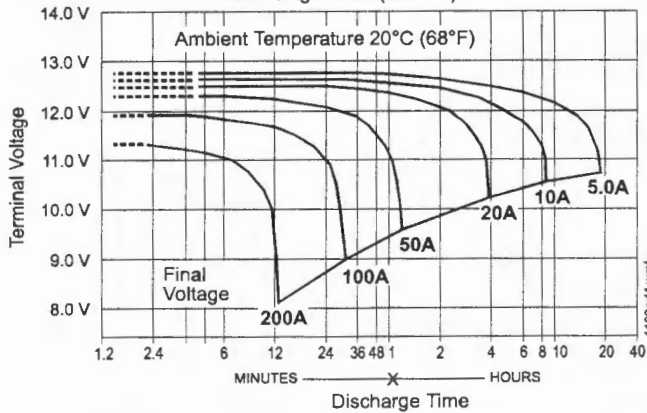

at left:
PS-1210000
Discharge
Characteristics

B & B BATTERY

Model	V	Nominal Capacity (AH)				Weight		Terminal				Dimensions							
								Standard		Optional		L		W		H		TH	
		20 hr	10 hr	5 hr	1 hr	kg	lbs	Type	Pos.	Type	Pos.	mm	in	mm	in	mm	in	mm	in
BP5-12	12	5.00	4.75	4.25	3.00	1.86	4.10	T1	3	T2		90	3.54	70	2.76	102	4.02	106	4.17
BP7-12	12	7.00	6.65	5.95	4.20	2.60	5.73	T2	5	T1		151	5.94	65	2.56	93	3.66	98	3.86
BP12-12	12	12.00	11.40	10.20	7.20	4.03	8.89	B1	5	T1		151	5.94	98	3.86	94	3.70	98	3.86
BP26-12	12	26.00	24.70	22.10	15.60	9.40	20.73	B1	7	T2.11	9	175	6.89	166	6.54	125	4.92	125	4.92

Charging Procedure

Application	Charging method	Charging voltage at 20°C (V/cell)	Temperature compensation coefficient of charging voltage (mV/°C/cell)	Maximum charging current (CA)	Charging time 0.1 CA, 20°C (h)		Temp (°C)
					100% discharge	50% discharge	
For standby power source	Constant voltage and constant current charging (with current restriction)	2.25 ~ 2.30	- 3	0.3	24	20	0 - 40°C (32 ~104°F)
For cycle service		2.40 ~ 2.50	- 4	0.3	16	10	

Temperature compensation of charging voltage is not needed when using the batteries within 5°C to 35°C range.

Final Voltage	Discharge Time: for Model BP5-12								
	5 min	10 min	15 min	30 min	1 hr	3 hr	5 hr	10 hr	20 hr
	Battery Output Power (W): for Model BP5-12								
10.80 V	180.8	133.1	106.6	63.5	36.39	14.57	10.05	5.62	2.94
10.50 V	209.2	144.2	111.5	65.9	37.48	14.87	10.20	5.70	3.00
10.20 V	222.3	149.4	115.0	67.4	38.16	15.00	10.26	5.73	3.01
9.90 V	232.3	152.9	117.6	68.3	38.61	15.10	10.29	5.75	3.02
9.60 V	240.0	156.0	120.0	69.0	39.0	15.20	10.32	5.75	3.02

Constant Power Discharge Characteristics at 25°C/77°F for BP5-12

Final Voltage	Discharge Time: for Model BP7-12								
	5 min	10 min	15 min	30 min	1 hr	3 hr	5 hr	10 hr	20 hr
	Battery Output Power (W): for Model BP7-12								
10.80 V	253.1	186.3	149.3	88.8	50.95	20.40	14.07	7.86	4.11
10.50 V	292.9	201.8	156.2	92.2	52.47	20.81	14.28	7.98	4.20
10.20 V	311.2	209.1	161.0	94.3	53.42	21.00	14.36	8.02	4.22
9.90 V	325.2	214.1	164.7	95.6	54.06	21.15	14.41	8.04	4.23
9.60 V	336.0	218.4	168.0	96.6	54.60	21.27	14.45	8.04	4.23

Constant Power Discharge Characteristics at 25°C/77°F for BP7-12

Final Voltage	Discharge Time: for Model BP12-12								
	5 min	10 min	15 min	30 min	1 hr	3 hr	5 hr	10 hr	20 hr
	Battery Output Power (W): for Model BP12-12								
10.80 V	433.9	319.4	256.0	152.3	87.34	34.98	24.12	13.48	7.05
10.50 V	502.2	346.0	267.7	158.1	89.96	35.68	24.48	13.68	7.20
10.20 V	533.6	358.5	276.0	161.7	91.57	36.00	24.61	13.75	7.23
9.90 V	557.5	367.1	282.4	164.0	92.67	36.25	24.70	13.79	7.25
9.60 V	576.0	374.4	288.0	165.6	93.60	36.47	24.77	13.79	7.25

Constant Power Discharge Characteristics at 25°C/77°F for BP12-12

Final Voltage	Discharge Time: for Model BP26-12								
	5 min	10 min	15 min	30 min	1 hr	3 hr	5 hr	10 hr	20 hr
	Battery Output Power (W): for Model BP26-12								
10.80 V	940.0	692.0	554.6	330.0	189.23	75.79	52.25	29.20	15.26
10.50 V	1088.0	749.7	580.0	342.5	194.91	77.30	53.04	29.64	15.60
10.20 V	1156.0	776.7	598.0	350.3	198.41	78.00	53.33	29.79	15.67
9.90 V	1208.0	795.3	611.8	355.2	200.79	78.54	53.52	29.88	15.71
9.60 V	1248.0	811.2	624.0	358.8	202.80	79.01	53.68	29.88	15.71

Constant Power Discharge Characteristics at 25°C/77°F for BP26-12

B & B BATTERY

BP5-12 Battery Discharge Characteristics (25°C/77°F)

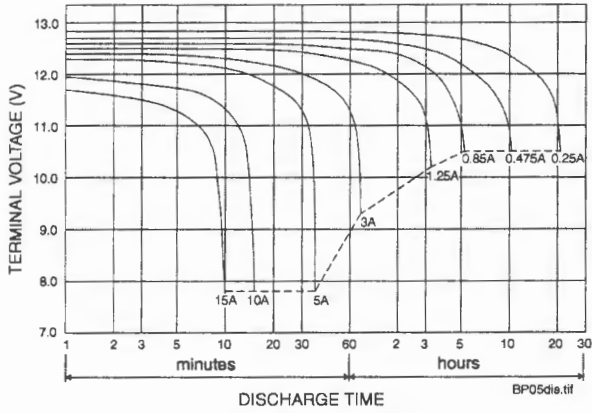

BP7-12 Battery Discharge Characteristics (25°C/77°F)

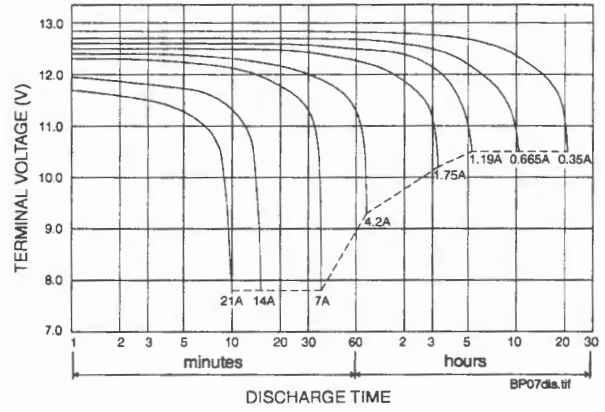

BP12-12 Battery Discharge Characteristics (25°C/77°F)

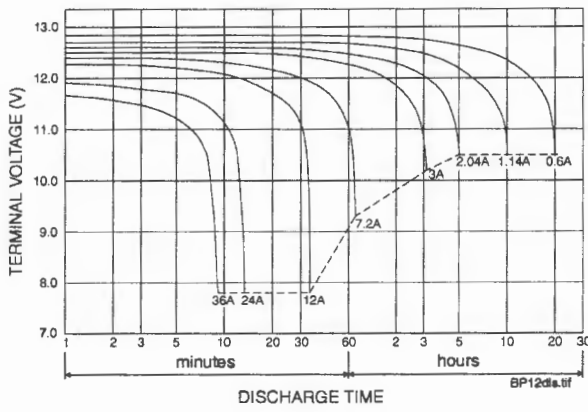

BP26-12 Battery Discharge Characteristics (25°C/77°F)

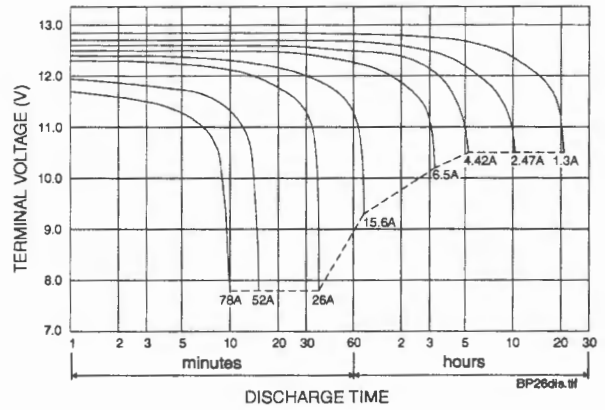

BP05-12



BP12-12



BP26-12



UPG BATTERY

UB1250 has the same specifications as previous Jolt SA1250; SA1272 to be replaced with UB1270 (specs/diagrams pending).

UB1250 (previously SA1250) Diagrams

UB1250/SA1250 discharge current vs. time

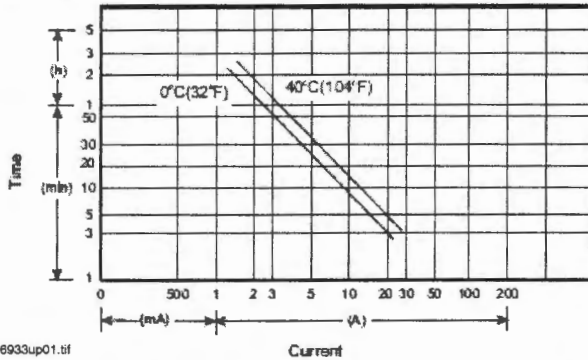

6933up01.tif

UB1250/SA1250 discharge characteristics (25°C/77°F)

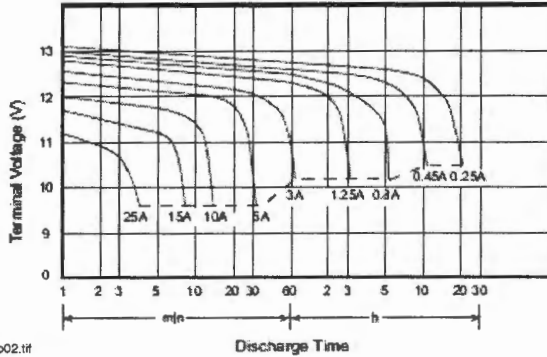

6933up02.tif

UB1250, SA1250 Specifications

- Nominal voltage: 12 V.
- Nominal capacity (20 hr): 5.0 AH.
- Dimensions: total height 107 mm (4.21"); container height 101 mm (3.98"); length 90 mm (3.54"); width 70 mm (2.76").
- Weight: approximately 1.83 kg (4.03 lbs).
- Container material: UL94HB ABS, UL94V-0 ABS.
- Internal resistance (25°C, 77°F): ~ 32 m.
- Discharge capacity under different temperatures:
 - 40°C: ~ 102%
 - 25°C: ~ 100%
 - 0°C: ~ 85%
- Capacity 25°C/77°F:
 - 20 hr @ 0.25 A: 5.0 AH.
 - 5 hr @ 0.8 A: 4.0 AH.
 - 1 hr @ 3.0 A: 3.0 AH.
 - 1 C @ 5.0 A: 2.5 AH.
- Charging voltage (25°C, 77°F):
 - Standby use: 13.65 V ± 0.15 V.
 - Cycle use: 14.7 V ± 0.3 V.
- Maximum discharge current: 60 A (5 sec).
- Maximum charging current: 1.5 A.
- Self-discharge residual capacity (25°C, 77°F):
 - After 3 months: ~ 90%.
 - After 6 months: ~ 82%.
 - After 12 months: ~ 70%.

SA1272 Diagrams

SA1272 discharge current vs. time

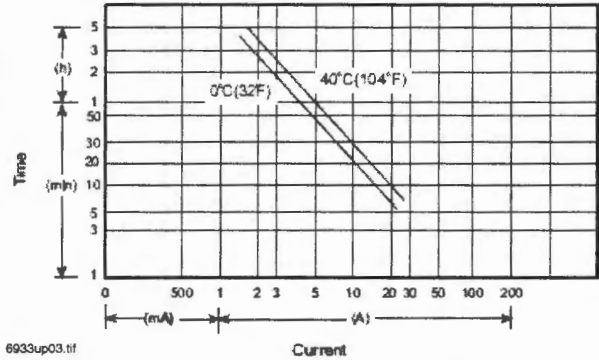

6933up03.tif

SA1272 discharge characteristics (25°C/77°F)

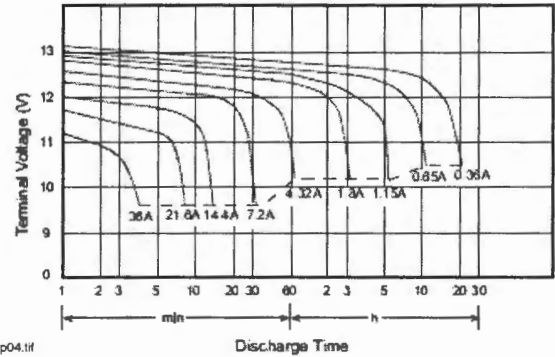

6933up04.tif

SA1272 Specifications

- Nominal voltage: 12 V.
- Nominal capacity (20 hr): 7.2 AH.
- Dimensions: total height 100 mm (3.94"); container height 94 mm (3.70"); length 151 mm (5.95"); width 65 mm (2.56").
- Weight: approximately 2.66 kg (5.85 lbs).
- Container material: UL94HB ABS, UL94V-0 ABS.
- Internal resistance (25°C, 77°F): ~ 22 m.
- Discharge capacity under different temperatures:
 - 40°C: ~ 102%
 - 25°C: ~ 100%
 - 0°C: ~ 85%
- Capacity 25°C/77°F:
 - 20 hr @ 0.36 A: 7.2 AH.
 - 5 hr @ 1.15 A: 5.76 AH.
 - 1 hr @ 4.32 A: 4.32 AH.
 - 1 C @ 7.2 A: 3.6 AH.
- Charging voltage (25°C, 77°F):
 - Standby use: 13.65 V ± 0.15 V.
 - Cycle use: 14.7 V ± 0.3 V.
- Maximum discharge current: 90 A (5 sec).
- Maximum charging current: 2.16 A.
- Self-discharge residual capacity (25°C, 77°F):
 - After 3 months: ~ 90%.
 - After 6 months: ~ 82%.
 - After 12 months: ~ 70%.

UPG BATTERY

Same specifications as previous Jolt models;
packaging and part numbers are the only changes.

UB12120 (was SA12120) Diagrams

UB12120/SA12120 discharge current vs. time

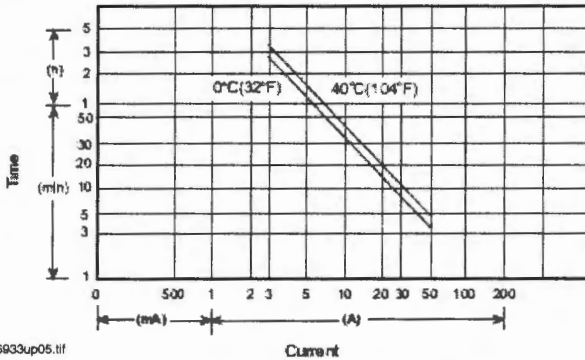

6933up05.tif

UB12180 (was SA12180) Diagrams

UB12180/SA12180 discharge current vs. time

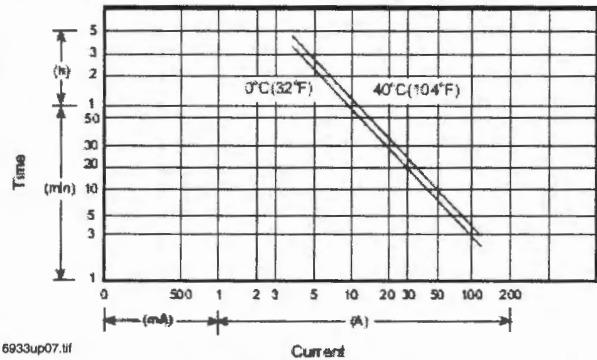

6933up07.tif

UB12120/SA12120 discharge characteristics (25°C/77°F)

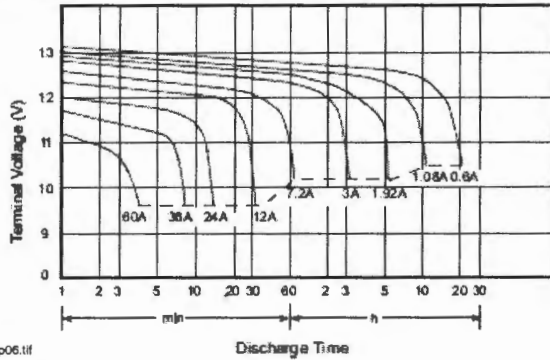

6933up06.tif

UB12180/SA12180 discharge characteristics (25°C/77°F)

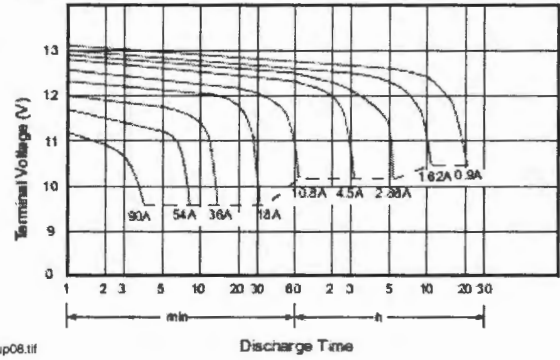

6933up08.tif

UB12120, SA12120 Specifications

- Nominal voltage: 12 V.
 - Nominal capacity (20 hr): 12.0 AH.
 - Dimensions: total height 100 mm (3.94"); container height 94 mm (3.70"); length 151 mm (5.95"); width 98 mm (3.86").
 - Weight: approximately 4.10 kg (9.04 lbs).
 - Container material: UL94HB ABS, UL94V-0 ABS.
 - Internal resistance (25°C, 77°F): ~ 14 m.
 - Discharge capacity under different temperatures:
 - 40°C: ~ 102%
 - 25°C: ~ 100%
 - 0°C: ~ 85%
 - Capacity 25°C/77°F:
 - 20 hr @ 0.6 A: 12.0 AH.
 - 5 hr @ 1.92 A: 9.6 AH.
 - 1 hr @ 7.2 A: 7.2 AH.
 - 1 C @ 12.0 A: 6.0 AH.
 - Charging voltage (25°C, 77°F):
 - Standby use: 13.65 V ± 0.15 V.
 - Cycle use: 14.7 V ± 0.3 V.
- Maximum discharge current: 120 A (5 sec).
Maximum charging current: 3.6 A.
Self-discharge residual capacity (25°C, 77°F):
After 3 months: ~ 90%.
After 6 months: ~ 82%.
After 12 months: ~ 70%.

UB12180, SA12180 Specifications

- Nominal voltage: 12 V.
 - Nominal capacity (20 hr): 18.0 AH.
 - Dimensions: total height 167 mm (6.58"); container height 167 mm (6.58"); length 181 mm (7.13"); width 76 mm (2.99").
 - Weight: approximately 6.06 kg (13.36 lbs).
 - Container material: UL94HB ABS, UL94V-0 ABS.
 - Internal resistance (25°C, 77°F): ~ 13 m.
 - Discharge capacity under different temperatures:
 - 40°C: ~ 102%
 - 25°C: ~ 100%
 - 0°C: ~ 85%
 - Capacity 25°C/77°F:
 - 20 hr @ 0.9 A: 18.0 AH.
 - 5 hr @ 2.88 A: 14.4 AH.
 - 1 hr @ 10.8 A: 10.8 AH.
 - 1 C @ 18.0 A: 9.0 AH.
 - Charging voltage (25°C, 77°F):
 - Standby use: 13.65 V ± 0.15 V.
 - Cycle use: 14.7 V ± 0.3 V.
- Maximum discharge current: 300 A (5 sec).
Maximum charging current: 5.4 A.
Self-discharge residual capacity (25°C, 77°F):
After 3 months: ~ 90%.
After 6 months: ~ 82%.
After 12 months: ~ 70%.

UPG BATTERY

Same specifications as previous Jolt models; packaging and part numbers are the only changes.

UB121000 (XSA121000A) Diagrams

UB121000/XSA121000A discharge current vs. time

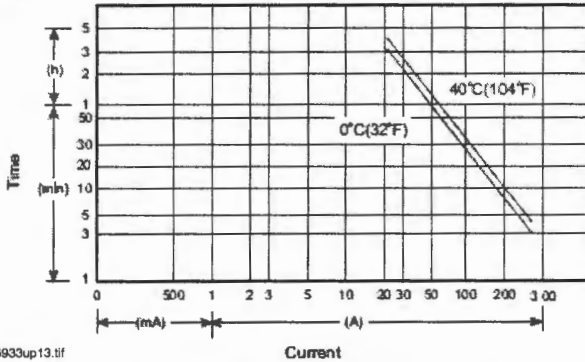

6933up13.tif

UB121000/XSA121000A discharge characteristics (25°C/77°F)

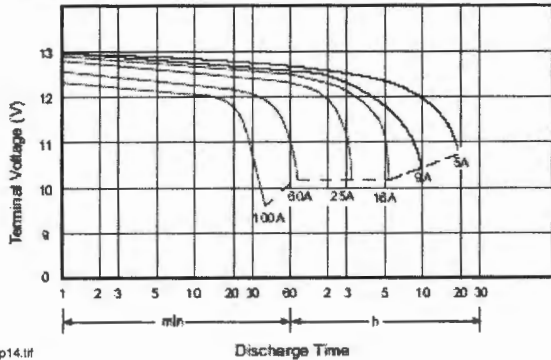

6933up14.tif

UB121000 (XSA121000A) Diagrams

- Nominal voltage: 12 V.
- Nominal capacity (20 hr): 100.0 AH.
- Dimensions: total height 221 mm (8.70"); container height 214 mm (8.43"); length 329 mm (12.95"); width 172 mm (6.77").
- Weight: approximately 34.00 kg (74.8 lbs).
- Container material: UL94HB ABS, UL94V-0 ABS.
- Internal resistance (25°C, 77°F): ~ 6.5 m.
- Discharge capacity under different temperatures:
 - 40°C: ~ 102%
 - 25°C: ~ 100%
 - 0°C: ~ 85%
- Capacity 25°C/77°F:
 - 20 hr @ 5.0 A: 100.0 AH.
 - 5 hr @ 16.0 A: 80.0 AH.
 - 1 hr @ 60.0 A: 60.0 AH.
 - 1 C @ 100.0 A: 50.0 AH.
- Charging voltage (25°C, 77°F):
 - Standby use: 13.65 V ± 0.15 V.
 - Cycle use: 14.7 V ± 0.3 V.
- Maximum discharge current: 600 A (5 sec).
- Maximum charging current: 30 A.
- Self-discharge residual capacity (25°C, 77°F):
 - After 3 months: ~ 90%.
 - After 6 months: ~ 82%.
 - After 12 months: ~ 70%.

UPG Summary Diagrams

Summary discharge characteristics

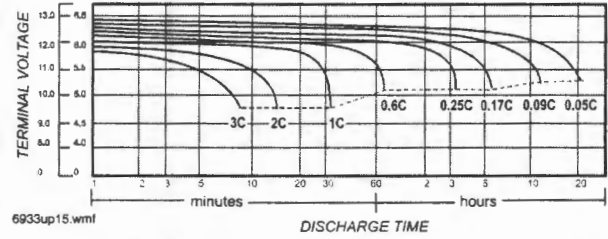

6933up15.wml

Summary discharge current vs. time curve (25°C/77°F)

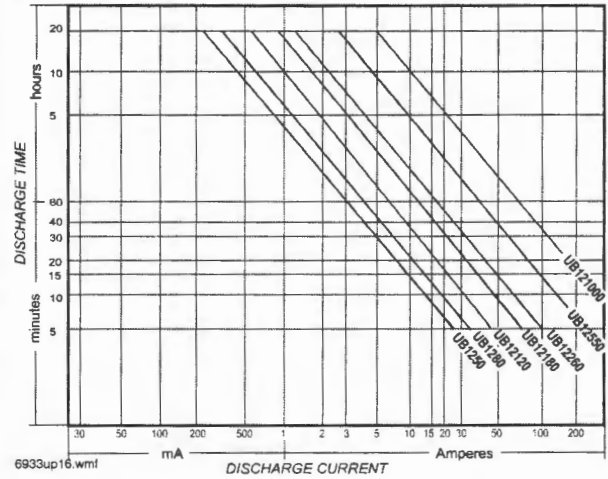

6933up16.wml



6933ub1280.jpg



6933ub12260.jpg

UPG BATTERY

Same specifications as previous Jolt models;
packaging and part numbers are the only changes.

Charging Procedure: UPG Battery

Application	Charging method	Charging voltage at 25°C (V/cell)	Temperature compensation coefficient of charging voltage (mV/°C/cell)	Maximum charging current (CA)	Charging time 0.1 CA, 25°C (h)		Temp (°C)
					100% discharge	50% discharge	
For standby power source	Constant voltage and constant current charging (with current restriction)	2.25 ~ 2.30	-3.3 (-1.8 mV/°F/cell)	0.3	T ^a 24	T ^a 20	0 - 40°C (32 - 104°F)
For cycle service		2.40 ~ 2.50	-5 (-2.8 mV/°F/cell)	0.3	16 < T < 24	10 < T < 24	

Temperature compensation of charging voltage is not needed when using the batteries within 5°C to 35°C range.

NOTIFIER® is a registered trademark of Honeywell International Inc.
Batteries display trademarks of the manufacturer.
©2009 by Honeywell International Inc. All rights reserved. Unauthorized use
of this document is strictly prohibited.

ISO 9001
CERTIFIED
ENGINEERING & MANUFACTURING
QUALITY SYSTEMS

This document is not intended to be used for installation purposes.
We try to keep our product information up-to-date and accurate.
We cannot cover all specific applications or anticipate all requirements.
All specifications are subject to change without notice.

For more information, contact Notifier. Phone: (203) 484-7161, FAX: (203) 484-7118.
www.notifier.com

➔ NOT-BG12LX

Addressable Manual Pull Station For FireWarden Series Panels

 **NOTIFIER**[®]
by Honeywell

Intelligent/Addressable Devices

General

The Notifier NOT-BG12LX is a state-of-the-art, dual-action (i.e., requires two motions to activate the station) pull station that includes an addressable interface for FireWarden series intelligent control panels, and the NSP-25 panel. Because the NOT-BG12LX is addressable, the control panel can display the exact location of the activated manual station. This leads fire personnel quickly to the location of the alarm.

Features

- Maintenance personnel can open station for inspection and address setting without causing an alarm condition.
- Built-in bicolor LED, which is visible through the handle of the station, flashes in normal operation and latches steady red when in alarm.
- Handle latches in down position and the word "ACTIVATED" appears to clearly indicate the station has been operated.
- Captive screw terminals wire-ready for easy connection to SLC loop (accepts up to 12 AWG/3.25 mm² wire).
- Can be surface mounted (with SB-10 or SB-I/O) or semi-flush mounted. Semi-flush mount to a standard single-gang, double-gang, or 4" (10.16 cm) square electrical box.
- Smooth dual-action design.
- Meets ADAAG controls and operating mechanisms guidelines (Section 4.1.3[13]); meets ADA requirement for 5 lb. maximum activation force.
- Highly visible.
- Attractive shape and textured finish.
- Key reset.
- Includes Braille text on station handle.
- Optional trim ring (BG12TR).
- Meets UL 38, Standard for Manually Actuated Signaling Boxes.

Construction

Shell, door, and handle are molded of durable polycarbonate material with a textured finish.

Specifications

- **Shipping Weight:** 9.6 oz. (272.15 g)
- **Normal operating voltage:** 24 VDC.
- **Maximum SLC loop voltage:** 28.0 VDC.
- **Maximum SLC loop current:** μ A.
- **Temperature Range:** 32°F to 120°F (0°C to 49°C)
- **Relative Humidity:** 10% to 93% (noncondensing)
- **For use indoors in a dry location**

Installation

The NOT-BG12LX will mount semi-flush into a single-gang, double-gang, or standard 4" (10.16 cm) square electrical outlet box, or will surface mount to the model SB-10 or SB-I/O surface backbox. If the NOT-BG12LX is being semi-flush mounted, then the optional trim ring (BG12TR) may be used.



The NOT-BG12LX
Addressable Manual Pull Station

The BG12TR is usually needed for semi-flush mounting with 4" (10.16 cm) or double-gang boxes (not with single-gang boxes).

Operation

Pushing in, then pulling down on the handle causes it to latch in the down/activated position. Once latched, the word "ACTIVATED" (in bright yellow) appears at the top of the handle, while a portion of the handle protrudes from the bottom of the station. To reset the station, simply unlock the station with the key and pull the door open. This action resets the handle; closing the door automatically resets the switch.

Each manual station, on command from the control panel, sends data to the panel representing the state of the manual switch. Two rotary decimal switches allow address settings (1 – 99 on NFW2-100/NFW2-100C, 1 – 50 for NFW-50/NFW-50C).

Architectural/Engineering Specifications

Manual Fire Alarm Stations shall be non-coded, with a key-operated reset lock in order that they may be tested, and so designed that after actual Emergency Operation, they cannot be restored to normal except by use of a key. An operated station shall automatically condition itself so as to be visually detected as activated. Manual stations shall be constructed of red-colored polycarbonate material with clearly visible operating instructions provided on the cover. The word FIRE shall appear on the front of the stations in white letters, 1.00 inches (2.54 cm) or larger. Stations shall be suitable for surface mounting on matching backbox SB-10 or SB-I/O; or semi-flush mounting on a standard single-gang, double-gang, or 4" (10.16 cm) square electrical box, and shall be installed within

the limits defined by the Americans with Disabilities Act (ADA) or per national/local requirements. Manual Stations shall be Underwriters Laboratories listed.

Manual stations shall connect with two wires to one of the control panel SLC loops. The manual station shall, on command from the control panel, send data to the panel representing the state of the manual switch. Manual stations shall provide address setting by use of rotary decimal switches.

Product Line Information

NOT-BG12LX: Dual-action addressable pull station. Includes key locking feature.

NOT-BG12LXA: *Canadian* Dual-action addressable pull station. Includes key locking feature.

SB-10: Surface backbox; metal.

SB-I/O: Surface backbox; plastic.

BG12TR: Optional trim ring.

17021: Keys, set of two.

Agency Listings and Approvals

In some cases, certain modules or applications may not be listed by certain approval agencies, or listing may be in process. Consult factory for latest listing status.

- **UL Listed:** S692 (listed for Canadian and non-Canadian applications)
- **MEA:** 67-02-E Vol. IV
- **CSFM:** 7150-0028:0199
- **FDNY:**
- **FM Approved**

Patented: U.S. Patent No. D428,351; 6,380,846; 6,314,772; 6,632,108.

Notifier® is a registered trademark of Honeywell International Inc.
©2010 by Honeywell International Inc. All rights reserved. Unauthorized use of this document is strictly prohibited.



This document is not intended to be used for installation purposes.
We try to keep our product information up-to-date and accurate.
We cannot cover all specific applications or anticipate all requirements.
All specifications are subject to change without notice.



Made in the U.S. A.

For more information, contact Notifier. Phone: (203) 484-7161, FAX: (203) 484-7118.
www.notifier.com

→ NP-100(A), NP-100T(A), NP-100R(A)

**Addressable Photoelectric Detectors
for the FireWarden Series**

NOTIFIER[®]
by Honeywell

Addressable

General

The NP-100 and NP-100T addressable, low-profile plug-in photoelectric detectors use a state-of-the-art photoelectric sensing chamber with communications to provide open area protection and are used exclusively with NOTIFIER's **FireWarden Series** (FireWarden-100-2 and FireWarden-50) Addressable Fire Alarm Control Panels (FACPs). The NP-100T adds thermal sensors that will alarm at a fixed temperature of 135°F (57°C). Since these detectors are addressable, they will help emergency personnel quickly locate a fire during its early stages, potentially saving precious rescue time while also reducing property damage. Two LEDs on each sensor light to provide a local, visible sensor indication. Remote LED annunciator capability is available as an optional accessory (P/N RA100Z(A)). The NP-100R is a remote test capable detector for use with DNR(W) duct smoke detector housings.

Features

SLC loop:

- Two-wire loop connection.
- Unit uses base for wiring.

Addressing:

- Addressable by device.
- Direct Decade entry of address: 01 – 99 with FireWarden-100-2, and 01 – 50 with FireWarden-50.

Architecture:

- Unique single-source, dual-chamber design to respond quickly and dependably to a broad range of fires.
- Sleek, low-profile design.
- Integral communications and built-in type identification.
- Built-in tamper-resistant feature.
- Removable cover and insect-resistant screen for simple field cleaning.

Operation:

- Withstands air velocities up to 4,000 feet-per-minute (20 m/sec.) without triggering a false alarm.
- Factory preset at 1.5% nominal sensitivity for panel alarm threshold level.
- Visible LED "blinks" when the unit is addressed (communicating with the fire panel) and latches on in alarm.

Mechanicals:

- Sealed against back pressure.
- Direct surface mounting or electrical box mounting.
- Mounts to: single-gang box, 3.5" (8.89 cm) or 4.0" (10.16 cm) octagonal box, or 4.0" (10.16 cm) square electrical box (using a plaster ring — included).

Other system features:

- Fully coated circuit boards and superior RF/transient protection.
- 94-V0 plastic flammability rating.
- Low standby current.

Options:

- Remote LED output connection (P/N RA100Z).



NP-100 with B710LP base



NP-100T with B710LP base

Applications

Use photoelectric detectors in life-safety applications to provide a broad range of fire-sensing capability, especially where smoldering fires are anticipated. Ionization detectors are often better than photoelectric detectors at sensing fast, flaming fires.

Construction

These detectors are constructed of off-white LEXAN®. NP-100(T) plug-in, low-profile smoke detectors are designed to commercial standards and offer an attractive appearance.

Installation

NP-100(T) plug-in detectors use a detachable mounting base to simplify installation, service and maintenance. Mount base on box which is at least 1.5 inches (3.81 cm) deep. Suitable boxes include:

- 4.0" (10.16 cm) square box with plaster ring.
- 4.0" (10.16 cm) octagonal box.
- 3.5" (8.89 cm) octagonal box.
- Single-gang box.

NOTE: Because of the inherent supervision provided by the SLC loop, **end-of-line resistors** are not required. Wiring "T-taps" or branches are permitted for Style 4 (Class B) wiring. NP-100R mounts in a DNR(W) duct detector housing.

Operation

Each NP-100/T/R uses one of 99 possible addresses on the FireWarden-100-2 and one of 50 possible addresses on the FireWarden-50 Signaling Line Circuit (SLC). It responds to regular polls from the system and reports its type and status.

The NP-100/T/R addressable photoelectric sensor's unique unipolar chamber responds quickly and uniformly to a broad range of smoke conditions and can withstand wind gusts up to 4,000 feet-per-minute (20 m/sec.) without sending an alarm level signal. Because of its unipolar chamber, the NP-100/T/R is approximately two times more responsive than most photoelectric sensors. This makes it a more stable detector.

Detector Sensitivity Test

Each detector can have its sensitivity tested (required per NFPA 72, Chapter 14 on *Inspection, Testing and Maintenance*) when installed/connected to a FireWarden-100-2 or FireWarden-50 addressable fire alarm control panel. The results of the sensitivity test can be printed off the FireWarden-100-2 or FireWarden-50 for record keeping.

Specification

Voltage range: 15 – 32 VDC (peak).

Standby current: 300 µA @ 24 VDC.

LED current: 6.5 mA @ 24 VDC (latched "ON").

Air velocity: 4,000 ft./min. (20 m/sec.) maximum.

Diameter: 6.1" (15.5 cm) installed in B710LP base.

Height: 2.1" (5.33 cm) installed in B710LP base.

Weight: 3.6 oz. (102 g).

Operating temperature range: for **NP-100:** 0°C to 49°C (32°F to 120°F); for **NP-100T:** 0°C to 38°C (32°F to 100°F). **NP-100R:** installed in a DNR(W) -20°C to 70°C (-4°F to 158°F).

Temperature: 0°C – 49°C (32°F – 120°F).

Relative humidity: 10% – 93%, non-condensing.

Listings

Listings and approvals below apply to the NP-100 and NP-100T detectors. In some cases, certain modules may not be listed by certain approval agencies, or listing may be in process. Consult factory for latest listing status.

- UL Listed, file S1115.
- CSFM approved: file 7272-0028:231.
- MEA approved: file 243-02-E Vol. 2.
- Maryland State Fire Marshal: permit 2173.
- FM approved.

Product Line Information

NP-100: Addressable photoelectric detector; B710LP base included.

NP-100A: Same as NP-100 with ULC Listing (B710LPA base included).

NP-100T: Same as NP-100 but with *thermal* element; B710LP base included.

NP-100TA: Same as NP-100T with ULC Listing (B710LPABase included).

NP-100R: Remote test capable addressable photoelectric detector for use with a DNR(W) duct detector housing.

B710LP: Plug-in detector base. Dimensions: 6.1" (15.5 cm). Mounting: 4.0" (10.16 cm) square box with or without plaster ring, 4.0" (10.16 cm) octagonal box, 3.5" (8.89 cm) octagonal box, or single-gang box. All mounting boxes have a minimum depth of 1.5" (3.81 cm).

B224RB: Plug-in System Sensor *relay* detector base. **Diameter:** 6.2" (15.75 cm). **Mounting:** 4.0" (10.16 cm) square box with or without plaster ring, 4.0" (10.16 cm) octagonal box, or 3.5" (8.89 cm) octagonal box. All mounting boxes have a minimum depth of 1.5" (3.81 cm).

B224BI: Plug-in System Sensor *isolator* detector base. Maximum 25 devices between isolator bases (*see DN-6994*). **Diameter:** 6.2" (15.75 cm). **Mounting:** 4.0" (10.16 cm) square box with or without plaster ring, 4.0" (10.16 cm) octagonal box, or 3.5" (8.89 cm) octagonal box. All mounting boxes have a minimum depth of 1.5" (3.81 cm).

B200SR: Sounder base capable of producing temporal-3 or steady sound output.

ACCESSORIES:

RA100Z(A): Remote LED annunciator. 3 – 32 VDC. Mounts to a U.S. single-gang electrical box. *For use with B501 and B710LP bases only.*

SMK400E: Surface mounting kit provides for entry of surface wiring conduit. *For use with B501 base only.*

RMK400: Recessed mounting kit. *For use with B501 base only.*

M02-04-00: Test magnet.

M02-09-00: Test magnet with telescoping handle.

XR2B: Detector removal tool. Allows installation and/or removal of detector heads from bases in high ceiling applications.

XP-4: Extension pole for XR2B. Comes in three 5-foot (1.524 m) sections.

T55-127-010: Detector removal tool without pole.

BCK-200B: Black detector covers, box of 10 .

WCK-200B: White detector covers, box of 10 .

NOTIFIER® is a registered trademark of Honeywell International Inc. Bayblend® is a registered trademark of Bayer Corporation. ©2008 by Honeywell International Inc. All rights reserved. Unauthorized use of this document is strictly prohibited.



This document is not intended to be used for installation purposes.
We try to keep our product information up-to-date and accurate.
We cannot cover all specific applications or anticipate all requirements.
All specifications are subject to change without notice.

For more information, contact Notifier. Phone: (203) 484-7161, FAX: (203) 484-7118.
www.notifier.com

➔ NH-100 Series

Intelligent Addressable Thermal Detectors for FireWarden Series

 **NOTIFIER**[®]
by Honeywell

Addressable

General

The **NOTIFIER NH-100 Series** thermal detectors are addressable sensors that use a state-of-the-art thermistor sensing circuit for fast response. These sensors provide open-area protection and are intended for use with the **FireWarden Series** (FireWarden-100-2 and FireWarden-50) addressable Fire Alarm Control Panels (FACPs).

The **NH-100** and **NH-100R** sensors provide fixed temperature alarm detection at 135°F (57°C). The **NH-100R** sensor also responds to rate-of-rise conditions of greater than 15°F (8.3°C) per minute. The **NH-100H** is a fixed high-temperature detector that activates at 190°F (88°C). These thermal detectors provide addressable property protection in a variety of applications.

Two LEDs on each sensor light to provide a local, visible sensor indication. Remote LED annunciator capability is available as an optional accessory (**RA400Z**).

Features

SLC loop:

- Two-wire SLC loop connection.
- Unit uses base for wiring.

Addressing:

- Addressable by device.
- Direct Decade entry of address: 01 – 99 with FireWarden-100-2, 01 – 50 with FireWarden-50.

Architecture:

- Sleek, low-profile, stylish design.
- State-of-the-art thermistor technology for fast response.
- Integral communications and built-in device-type identification.
- Built-in tamper resistant feature.
- Built-in functional test switch activated by external magnet.

Operation:

- Factory preset at 135°F (57°C) for the NH-100 and NH-100R; 190°F (88°C) for the NH-100H.
- Rate-of-rise triggers at 15°F (8.3°C) per minute for the NH-100R.
- 360°-field viewing angle of the visual alarm indicators (two bicolor LEDs). LEDs blink green in Normal condition and turn on steady red in Alarm.
- Visible LEDs “blink” every time the unit is addressed.

Mechanicals:

- Sealed against back pressure.
- SEMS screws for wiring of the separate base.
- Designed for direct-surface or electrical-box mounting.
- Plugs into separate base for ease of installation and maintenance.
- Separate base allows interchange of photoelectric, ionization and thermal sensors.

Other system features:

- Remote test feature from the panel.
- Walk test with address display.

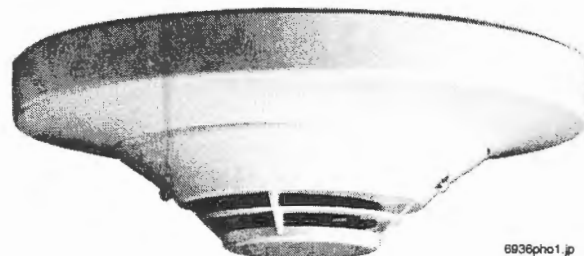

6936photo1.jp

NH-100 with B710LP base

- Low standby current.
- 94-5V plastic flammability rating.

Options:

- Remote LED output connection to optional RA400Z remote LED annunciator.
- Recessed (**RMK400**) or surface (**SMK400E**) base mounting kits.

Installation

NH-100 Series plug-in intelligent thermal detectors use a detachable base to simplify installation, service and maintenance. Installation instructions are shipped with each detector.

Mount base (all base types) on box that is at least 1.5" (3.81 cm) deep. Suitable boxes include:

- 4.0" (10.16 cm) square box.
- 3.5" (8.89 cm) or 4.0" (10.16 cm) octagonal box.
- Single-gang box (except relay or isolator base).

NOTE: Because of the inherent supervision provided by the SLC loop, end-of-line resistors are not required. Wiring “T-taps” or branches are permitted for Style 4 (Class “B”) wiring only.

Applications

Use thermal detectors for protection of property.

Construction

These detectors are constructed of off-white Bayblend[®]. The NH-100 Series plug-in intelligent thermal detectors are designed to commercial standards and offer an attractive appearance.

Operation

Each NH-100 Series detector uses one of 99 (FireWarden-100-2) or 50 (FireWarden-50) possible addresses on a control panel SLC loop. It responds to regular polls from the control panel and reports its type and the status. If it receives a test command from the panel (or a local magnet test), it stimulates its electronics and reports an alarm. It blinks its LEDs when polled and turns the LEDs on when commanded by the panel.

The NH-100 Series offers features and performance that represent the latest in thermal detector technology.

Specifications

Diameter: 6.1" (15.5 cm) installed in B710LP.

Height: 2.1" (5.33 cm).

Weight: 4.8 oz. (137 g).

Installation temperature:

- NH-100, NH-100R: -4°F to 100°F (-20°C to 38°C).
- NH-100H: -4°F to 150°F (-20°C to 66°C).

Humidity range: 10% to 93% relative humidity (noncondensing).

Voltage range: 15 to 32 VDC peak.

Standby current: 300 µA @ 24 VDC (one communication every five seconds with LED blink enabled).

LED current: 6.5 mA @ 24 VDC.

Mounting: B710LP flanged base, included.

Fixed-temperature setpoint: 135°F (57°C) for the NH-100 and NH-100R; 190°F (88°C) for the NH-100H.

Rate-of-rise detection: responds to greater than 15°F (8.3°C) per minute.

Altitude rating: 10,000 feet.

Listings and Approvals

Listings and approvals below apply to the NH-100 Series detectors. In some cases, certain modules may not be listed by certain approval agencies, or listing may be in process. Consult factory for latest listing status.

- UL Listed, file S747.
- CSFM approved: file 7270-0028:234.
- MEA approved: file 387-02-E Vol. II.
- FM approved.

Product Line Information

NH-100: Intelligent thermal sensor; 135° F (57° C) B710LP base included.

NH-100R: Same as NH-100 with *rate-of-rise* feature; B710LP base included.

NH-100H: Intelligent fixed high-temperature thermal detector; 190° F (88° C) B710LP base included.

B710LP: Plug-in detector base (included). **Dimensions:** 6.1" (15.5 cm). **Mounting:** 4.0" (10.16 cm) square box with or without plaster ring, 4.0" (10.16 cm) octagonal box, 3.5" (8.89 cm) octagonal box, or single-gang box. All mounting boxes have a minimum depth of 1.5" (3.81 cm).

B224RB: Plug-in System Sensor *relay* detector base. **Diameter:** 6.2" (15.75 cm). **Mounting:** 4.0" (10.16 cm) square box with or without plaster ring, 4.0" (10.16 cm) octagonal box, or 3.5" (8.89 cm) octagonal box. All mounting boxes have a minimum depth of 1.5" (3.81 cm).

B224BI: Plug-in System Sensor *isolator* detector base. Maximum 25 devices between isolator bases (see DN-6994). **Diameter:** 6.2" (15.75 cm). **Mounting:** 4.0" (10.16 cm) square

box with or without plaster ring, 4.0" (10.16 cm) octagonal box, or 3.5" (8.89 cm) octagonal box. All mounting boxes have a minimum depth of 1.5" (3.81 cm).

B501BH-2: Plug-in System Sensor standard *sounder* base. **Diameter:** 6.0" (15.24 cm). **Mounting:** 4.0" (10.16 cm) square box with or without plaster ring. Mounting boxes have a minimum depth of 1.5" (3.81 cm).

B501BHT-2: Plug-in System Sensor *temporal tone* sounder base.

ACCESSORIES:

RA400Z: Remote LED annunciator. 3 – 32 VDC. Mounts to a U.S. single-gang electrical box. For use with B501 and B710LP bases only.

SMK400E: Surface mounting kit provides for entry of surface wiring conduit. For use with B501 base only.

RMK400: Recessed mounting kit. For use with B501 base only.

M02-04-00: Test magnet.

M02-09-00: Test magnet with telescoping handle.

XR2B: Detector removal tool. Allows installation and/or removal of detector heads from bases in high ceiling applications.

XP-4: Extension pole for XR2B. Comes in three 5-foot (1.524 m) sections.

NOTIFIER® is a registered trademark of Honeywell International Inc. Bayblend® is a registered trademark of Bayer Corp. ©2009. All rights reserved. Unauthorized use of this document is strictly prohibited.



This document is not intended to be used for installation purposes. We try to keep our product information up-to-date and accurate. We cannot cover all specific applications or anticipate all requirements. All specifications are subject to change without notice.



Made in the U.S. A.

For more information, contact Notifier. Phone: (203) 484-7161, FAX: (203) 484-7118. www.notifier.com

➔ Monitor Modules

NMM-100(A), NMM-100P(A), NZM-100(A), and NDM-100(A) for FireWarden Series Panels



Intelligent Addressable Devices

General

Four different monitor modules are available for Notifier's FireWarden Series intelligent control panels for a variety of applications. Monitor modules supervise a circuit of dry-contact input devices, such as conventional heat detectors and pull stations, or monitor and power a circuit of two-wire smoke detectors (NZM-100(A)).

NMM-100(A) is a standard-sized module (typically mounts to a 4" [10.16 cm] square box) that supervises either a Style D (Class A) or Style B (Class B) circuit of dry-contact input devices.

➔ **NMM-100P(A)** is a miniature monitor module a mere 1.3" (3.302 cm) H x 2.75" (6.985 cm) W x 0.5" (1.270 cm) D that supervises a Style B (Class B) circuit of dry-contact input devices. Its compact design allows the NMM-100P(A) to often be mounted in a single-gang box behind the device it monitors.

NZM-100(A) is a standard-sized module that monitors and supervises compatible two-wire, 24 volt, smoke detectors on a Style D (Class A) or Style B (Class B) circuit.

NDM-100(A) is a standard-sized dual monitor module that monitors and supervises two independent two-wire Style B (Class B) dry-contact initiating device circuits (IDCs) at two separate, consecutive addresses in intelligent, two-wire systems.

NMM-100(A) Monitor Module

- Built-in type identification automatically identifies this device as a monitor module to the control panel.
- Powered directly by two-wire SLC loop. No additional power required.
- High noise (EMF/RFI) immunity.
- SEMS screws with clamping plates for ease of wiring.
- Direct Decade entry of address: 01 – 99 on FireWarden-100-2, 01 – 50 on FireWarden-50.
- LED flashes during normal operation and latches on steady to indicate alarm.

The NMM-100(A) Monitor Module is intended for use in intelligent, two-wire systems, where the individual address of each module is selected using the built-in rotary switches. It provides either a two-wire or four-wire fault-tolerant Initiating Device Circuit (IDC) for normally-open-contact fire alarm and supervisory devices. The module has a panel-controlled LED indicator.

NMM-100(A) APPLICATIONS

Use to monitor a zone of four-wire smoke detectors, manual fire alarm pull stations, waterflow devices, or other normally open dry-contact alarm activation devices. May also be used to monitor normally-open supervisory devices with special supervisory indication at the control panel. Monitored circuit may be wired as an NFPA Style B (Class B) or Style D (Class A) Initiating Device Circuit. A 47K ohm End-of-Line Resistor (provided) terminates the Style B circuit. No resistor is required for supervision of the Style D circuit.

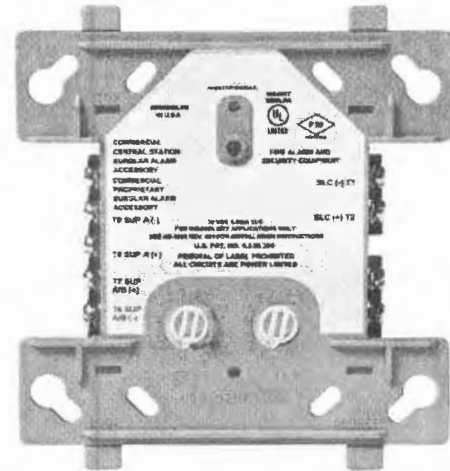

NMM-100(A) (Type H)

NMM-100(A) OPERATION

Each NMM-100(A) uses one of the available module addresses on an SLC loop. It responds to regular polls from the control panel and reports its type and the status (open/normal/short) of its Initiating Device Circuit (IDC). A flashing LED indicates that the module is in communication with the control panel. The LED latches steady on alarm (subject to current limitations on the loop).

NMM-100(A) SPECIFICATIONS

Nominal operating voltage: 15 to 32 VDC.

Maximum current draw: 5.0 mA (LED on).

Average operating current: 350 μ A (LED flashing), 1 communication every 5 seconds, 47k EOL.

Maximum IDC wiring resistance: 40 ohms.

EOL resistance: 47K ohms.

Temperature range: 32°F to 120°F (0°C to 49°C).

Humidity range: 10% to 93% noncondensing.

Dimensions: 4.5" (11.43 cm) high x 4" (10.16 cm) wide x 1.25" (3.175 cm) deep. Mounts to a 4" (10.16 cm) square x 2.125" (5.398 cm) deep box.

➔ NMM-100P(A) Mini Monitor Module

- Built-in type identification automatically identifies this device as a monitor module to the panel.
- Powered directly by two-wire SLC loop. No additional power required.
- High noise (EMF/RFI) immunity.
- Tinned, stripped leads for ease of wiring.
- Direct Decade entry of address: 01 – 99 on FireWarden-100-2, 01 – 50 on FireWarden-50.

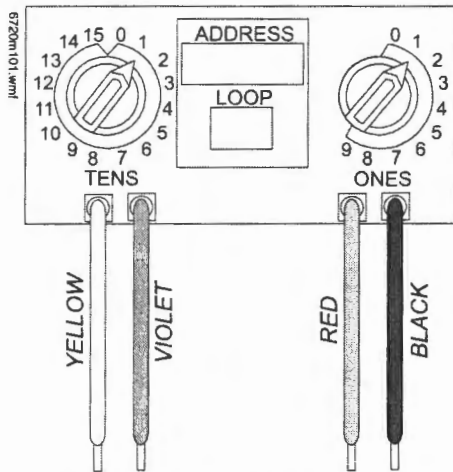

The NMM-100P(A) Mini Monitor Module can be installed in a single-gang junction directly behind the monitored unit. Its small size and light weight allow it to be installed without rigid mounting. The NMM-100P(A) is intended for use in intelligent, two-wire systems where the individual address of each module is selected using rotary switches. It provides a two-wire initiating device circuit for normally-open-contact fire alarm and security devices. NMM-100P(A)

NMM-100P(A) APPLICATIONS

Use to monitor a single device or a zone of four-wire smoke detectors, manual fire alarm pull stations, waterflow devices, or other normally-open dry-contact devices. May also be used to monitor normally-open supervisory devices with special supervisory indication at the control panel. Monitored circuit/device is wired as an NFPA Style B (Class B) Initiating Device Circuit. A 47K ohm End-of-Line Resistor (provided) terminates the circuit.

NMM-100P(A) OPERATION

Each NMM-100P(A) uses one of the available module addresses on an SLC loop. It responds to regular polls from the control panel and reports its type and the status (open/normal/short) of its Initiating Device Circuit (IDC).

NMM-100P(A) SPECIFICATIONS

Nominal operating voltage: 15 to 32 VDC.

Average operating current: 350 μ A, 1 communication every 5 seconds, 47k EOL; 600 μ A Max. (Communicating, IDC Shorted).

Maximum IDC wiring resistance: 40 ohms.

Maximum IDC Voltage: 11 Volts.

Maximum IDC Current: 400 μ A.

EOL resistance: 47K ohms.

Temperature range: 32°F to 120°F (0°C to 49°C).

Humidity range: 10% to 93% noncondensing.

Dimensions: 1.3" (3.302 cm) high x 2.75" (6.985 cm) wide x 0.65" (1.651 cm) deep.

Wire length: 6" (15.24 cm) minimum.

NZM-100(A) Interface Module

- Supports compatible two-wire smoke detectors.
- Supervises IDC wiring and connection of external power source.
- High noise (EMF/RFI) immunity.
- SEMS screws with clamping plates for ease of wiring.

- Direct Decade entry of address: 01 – 99 on FireWarden-100-2, 01 – 50 on FireWarden-50.
- LED flashes during normal operation.
- LED latches steady to indicate alarm on command from control panel.

The NZM-100(A) Interface Module is intended for use in intelligent, addressable systems, where the individual address of each module is selected using built-in rotary switches. This module allows intelligent panels to interface and monitor two-wire conventional smoke detectors. It transmits the status (normal, open, or alarm) of one full zone of conventional detectors back to the control panel. All two-wire detectors being monitored must be UL compatible with the module.

NZM-100(A) APPLICATIONS

Use the NZM-100(A) to monitor a zone of two-wire smoke detectors. The monitored circuit may be wired as an NFPA Style B (Class B) or Style D (Class A) Initiating Device Circuit. A 3.9 K ohm End-of-Line Resistor (provided) terminates the end of the Style B or D (class B or A) circuit (maximum IDC loop resistance is 25 ohms). Install ELR across terminals 8 and 9 for Style D application.

NZM-100(A) OPERATION

Each NZM-100(A) uses one of the available module addresses on an SLC loop. It responds to regular polls from the control panel and reports its type and the status (open/normal/short) of its Initiating Device Circuit (IDC). A flashing LED indicates that the module is in communication with the control panel. The LED latches steady on alarm (subject to current limitations on the loop).

NZM-100(A) SPECIFICATIONS

Nominal operating voltage: 15 to 32 VDC.

Maximum current draw: 5.1 mA (LED on).

Maximum IDC wiring resistance: 25 ohms.

Average operating current: 300 μ A, 1 communication and 1 LED flash every 5 seconds, 3.9k eol.

EOL resistance: 3.9K ohms.

External supply voltage (between Terminals T3 and T4):

DC voltage: 24 volts power limited. Ripple voltage: 0.1 Vrms maximum. Current: 90 mA per module maximum.

Temperature range: 32°F to 120°F (0°C to 49°C).

Humidity range: 10% to 93% noncondensing.

Dimensions: 4.5" (11.43 cm) high x 4" (10.16 cm) wide x 1.25" (3.175 cm) deep. Mounts to a 4" (10.16 cm) square x 2.125" (5.398 cm) deep box.

NDM-100(A) Dual Monitor Module

The NDM-100(A) Dual Monitor Module is intended for use in intelligent, two-wire systems. It provides two independent two-wire initiating device circuits (IDCs) at two separate, consecutive addresses. It is capable of monitoring normally open contact fire alarm and supervisory devices. The module has a single panel-controlled LED.

NOTE: The NDM-100(A) provides two Style B (Class B) IDC circuits ONLY. Style D (Class A) IDC circuits are NOT supported in any application.

NDM-100(A) SPECIFICATIONS

Normal operating voltage range: 15 to 32 VDC.

Maximum current draw: 6.4 mA (LED on).

Average operating current: 750 μ A (LED flashing).

Maximum IDC wiring resistance: 1,500 ohms.

Maximum IDC Voltage: 11 Volts.

Maximum IDC Current: 240 μ A

EOL resistance: 47K ohms.

Maximum SLC Wiring resistance: 40 Ohms.

Temperature range: 32° to 120°F (0° to 49°C).

Humidity range: 10% to 93% (non-condensing).

Dimensions: 4.5" (11.43 cm) high x 4" (10.16 cm) wide x 2.125" (5.398 cm) deep.

NDM-100(A) AUTOMATIC ADDRESSING

The NDM-100(A) automatically assigns itself to two addressable points, starting with the original address. For example, if the NDM-100(A) is set to address "26", then it will automatically assign itself to addresses "26" and "27".

NOTE: "Ones" addresses on the NDM-100(A) are 0, 2, 4, 6, or 8 only. Terminals 6 and 7 use the first address, and terminals 8 and 9 use the second address.



CAUTION:

Avoid duplicating addresses on the system.

Installation

NMM-100(A), NZM-100(A), and NDM-100(A) modules mount directly to a standard 4" (10.16 cm) square, 2.125" (5.398 cm) deep, electrical box. They may also be mounted to the SMB500 surface-mount box. Mounting hardware and installation instructions are provided with each module. All wiring must conform to applicable local codes, ordinances, and regulations. These modules are intended for power-limited wiring only.

The NMM-100P(A) module is intended to be wired and mounted without rigid connections inside a standard electrical box. All wiring must conform to applicable local codes, ordinances, and regulations.

Agency Listings and Approvals

In some cases, certain modules may not be listed by certain approval agencies, or listing may be in process. Consult factory for latest listing status.

- **UL:** S635
- **ULC:** S635
- **FM Approved**
- **CSFM:** 7300-0028:230 (NMM-100, NMM-100P, NZM-100); 7300-0028:237 (NDM-100)
- **MEA:** 72-01-E Vol. 2 (NMM-100, NMM-100P, NZM-100); 227-03-E Vol. 3 (NDM-100)

Product Line Information

NOTE: "A" or suffix indicates ULC-listed model.

NMM-100(A): Monitor module.

NMM-100P(A): Monitor module, miniature.

NZM-100(A): Monitor module, two-wire detectors.

NDM-100(A): Monitor module, dual, two independent Class B circuits.

SMB500: Optional surface-mount backbox.

NOTE: See installation instructions and refer to the SLC Wiring Manual, PN 52304.

Notifier® and FireWarden® are registered trademarks and FireWatch™ is a trademark of Honeywell International Inc.
©2009 by Honeywell International Inc. All rights reserved. Unauthorized use of this document is strictly prohibited.

ISO 9001
CERTIFIED
ENGINEERING & MANUFACTURING
QUALITY SYSTEMS

This document is not intended to be used for installation purposes.
We try to keep our product information up-to-date and accurate.
We cannot cover all specific applications or anticipate all requirements.
All specifications are subject to change without notice.



Made in the U.S. A.

For more information, contact Notifier. Phone: (203) 484-7161, FAX: (203) 484-7118.
www.notifier.com



Finally, Design and Safety Meet...

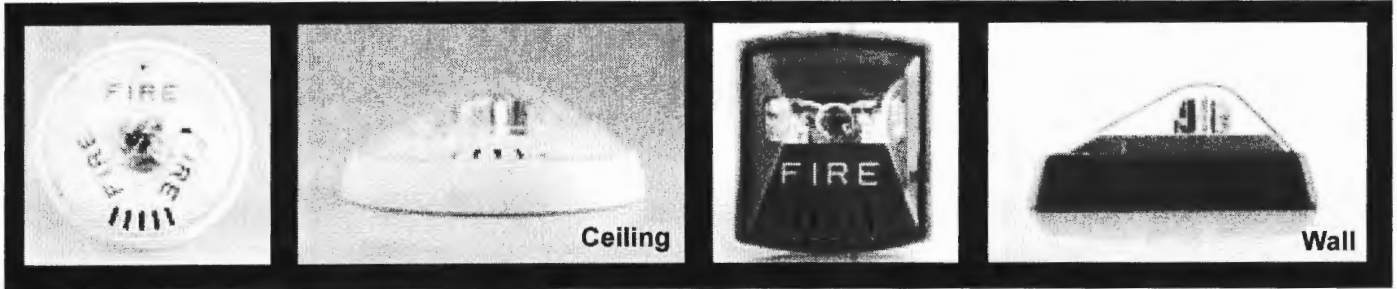









Description:

The Wheelock® Exceder™ Series of notification appliances feature a sleek modern design that will please building owners with reduced total cost of ownership. Installers will benefit from its comprehensive feature list, including the most candela options in one appliance, low current draw, no tools needed for setting changes, voltage test points, 12/24 VDC operation, universal mounting base and multiple mounting options for both new and retrofit construction.

The Wheelock® Exceder™ Series incorporates high reliability and high efficiency optics to minimize current draw allowing for a greater number of appliances on the notification appliance circuit. All strobe models feature an industry first of 8 candela settings on a single appliance. Models with an audible feature 3 sound settings (90, 95, 99 dB). All switches to change settings, can be set without the use of a tool and are located behind the appliance to prevent tampering. Wall models feature voltage test points to take readings with a voltage meter for troubleshooting and AHJ inspection.

The Wheelock® Exceder™ Series of wall and ceiling notification appliances feature a Universal Mounting Base (UMB) designed to simplify the installation and testing of horns, strobes, and combination horn strobes. The separate universal mounting base can be pre-wired to allow full testing of circuit wiring before the appliance is installed and the surface is finished. It comes complete with a Contact Cover for protection against dirt, dust, paint and damage to the contacts. The Contact Cover also acts as a shunting device to allow pre-wire testing for common wiring issues. The Contact Cover is polarized to prevent it from being installed incorrectly and prevents the appliance from being installed while it is on the UMB. When the Contact Cover is removed the circuit will show an open until the appliance is installed. The UMB allows for consistent installation and easy replacement of appliances if required. Wall models provide an optional locking screw for extra secure installation, while the ceiling models provide a captivated screw to prevent the screw from falling during installation.

- Save up to **48%** in current draw*
- Up to **9** models now in **1** appliance
- Save up to **14%** cost of installation**

-  Sleek Modern Aesthetics
-  Finger Slide Switches
-  Voltage Test Points
-  Multiple Voltages
-  3 Audible Settings
90, 95, 99 dB
-  8 Candela Settings ***
Wall - 15/1575/30/75/95/110/135/185
Ceiling - 15/30/60/75/95/115/150/177
-  Universal Mounting Base ***
Ceiling and Wall
Mounts to 5 Backbox Types
-  Environmentally Friendly
Low Current Draw

Compatibility and Requirements

- Synchronize using the Wheelock® Sync Modules or panels with built-in Wheelock® Patented Sync Protocol
- Compatible with UL "Regulated Voltage" using filtered VDC or unfiltered VRMS input voltage
- Strobes produce 1 flash per second over the "Regulated Voltage" range

* Compared to competitive models *** Patented
** Compared to previous models

NOTE: All CAUTIONS and WARNINGS are identified by the symbol ▲. All warnings are printed in bold capital letters.

▲ WARNING: PLEASE READ THESE SPECIFICATIONS AND ASSOCIATED INSTALLATION INSTRUCTIONS CAREFULLY BEFORE USING, SPECIFYING OR APPLYING THIS PRODUCT. VISIT WWW.COOPERNOTIFICATION.COM OR CONTACT COOPER NOTIFICATION FOR THE CURRENT INSTALLATION INSTRUCTIONS. FAILURE TO COMPLY WITH ANY OF THESE INSTRUCTIONS, CAUTIONS OR WARNINGS COULD RESULT IN IMPROPER APPLICATION, INSTALLATION AND/OR OPERATION OF THESE PRODUCTS IN AN EMERGENCY SITUATION, WHICH COULD RESULT IN PROPERTY DAMAGE, AND SERIOUS INJURY OR DEATH TO YOU AND/OR OTHERS.

General Notes:

General Notes:

- Strobes are designed to flash at 1 flash per second minimum over their "Regulated Voltage Range".
- All candela ratings represent minimum effective strobe intensity based on UL Standard 1971.
- Series Exceder Strobe products are Listed under UL Standards 1971 and 464 for indoor use with a temperature range of 32°F to 120°F (0°C to 49°C) and maximum humidity of 93% (± 2%) UL 464 (85% UL 1971).
- Series Exceder horns are under UL Standard 464 for audible signal appliances (Indoor use only).

Low Current Draw = Fewer Power Supplies

Strobe Ratings per UL Standard 1971

		UL Max Current*													
		24 VDC / 24 FWR												12 VDC	
Model	Regulated Voltage Range VDC	15	15/75	30	60	75	95	110	115	135	150	177	185	15	15/75
ST	8.0-33.0	0.057	0.070	0.085		0.135	0.163	0.182		0.205			0.253	0.110	0.140
STC	8.0-33.0	0.061		0.085	0.103	0.135	0.163		0.182		0.205	0.253		0.110	

Horn Strobe Ratings per UL 1971 & UL 464 at 24 VDC

		UL Max Current* at 99 dBA													
		24 VDC												12 VDC	
Model	Regulated Voltage Range VDC	15	15/75	30	60	75	95	110	115	135	150	177	185	15	15/75
HS	8.0-33.0	0.082	0.095	0.102		0.148	0.176	0.197		0.242			0.282	0.125	0.159
HSC	8.0-33.0	0.082		0.102	0.141	0.148	0.176		0.197		0.242	0.282		0.125	

		UL Max Current* at 95 dBA													
		24 VDC												12 VDC	
Model	Regulated Voltage Range VDC	15	15/75	30	60	75	95	110	115	135	150	177	185	15	15/75
HS	8.0-33.0	0.073	0.083	0.087		0.139	0.163	0.186		0.230			0.272	0.122	0.153
HSC	8.0-33.0	0.073		0.087	0.128	0.139	0.163		0.186		0.230	0.272		0.122	

		UL Max Current* at 90 dBA													
		24 VDC												12 VDC	
Model	Regulated Voltage Range VDC	15	15/75	30	60	75	95	110	115	135	150	177	185	15	15/75
HS	8.0-33.0	0.065	0.075	0.084		0.136	0.157	0.184		0.226			0.267	0.120	0.148
HSC	8.0-33.0	0.065		0.084	0.120	0.136	0.157		0.184		0.226	0.267		0.120	

Horn Ratings per UL 464

Model	Regulated Voltage Range VDC	99 dB	95 dB	90 dB
HN	16-33.0	0.064	0.044	0.022
HNC	16-33.0	0.084	0.044	0.022
HN	8.0-17.5	0.047	0.026	0.017
HNC	8.0-17.5	0.047	0.026	0.017



* UL max current rating is the maximum RMS current within the listed voltage range (16-33 VDC for 24 VDC units). For strobes the UL max current is usually at the minimum listed voltage (16 VDC for 24 VDC units). For audibles the max current is usually at the maximum listed voltage (33 VDC for 24 VDC units). For unfiltered ratings, see installation instructions.

Specification & Ordering Information

Model	Strobe Candela	Sync w/ SM, DSM or PS-6 & PS-8	12/24 VDC*	Mounting Options
Horn Strobes				
HSR	15/1575/30/75/95/110/135/185	X	X	UMB**
HSW	15/1575/30/75/95/110/135/185	X	X	UMB**
HSRC	15/30/60/75/95/115/150/177	X	X	UMB**
HSWC	15/30/60/75/95/115/150/177	X	X	UMB**
Strobes				
STR	15/1575/30/75/95/110/135/185	X	X	UMB**
STW	15/1575/30/75/95/110/135/185	X	X	UMB**
STRC	15/30/60/75/95/115/150/177	X	X	UMB**
STWC	15/30/60/75/95/115/150/177	X	X	UMB**
Horn				
HNR		X	X	UMB**
HNW		X	X	UMB**
HNRC		X	X	UMB**
HNWC		X	X	UMB**

*12 VDC models feature 15 & 15/75 settings

**UMB = Universal Mounting Base

Model Legend

- HN = Horn
- ST = Strobe
- HS = Horn Strobe
- C = Ceiling Mount
- W = White
- R = Red

Example 1: STRC = Strobe, Red, Ceiling Mount
 Example 2: HSR = Horn Strobe, Red, Wall Mount
 Example 3: HSW = Horn Strobe, White, Wall Mount



Example: HSR



Example: HSWC

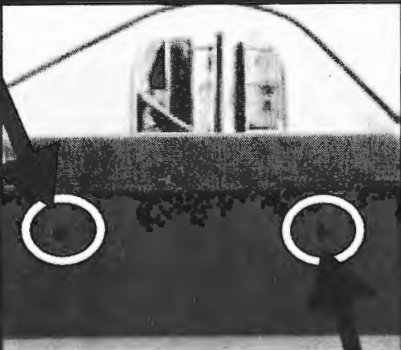

Voltage test points for quick troubleshooting and easy spot checking (wall models only)



8 candela settings

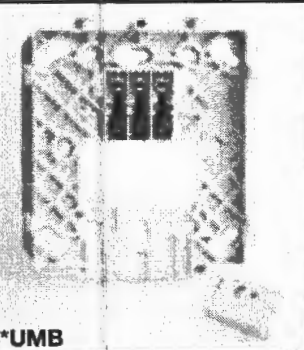

*UMB

Common base for wall and ceiling with 5 mounting options

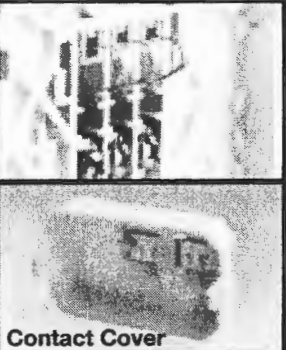

Contact Cover

NOTE: Due to continuous development of our products, specifications and offerings are subject to change without notice in accordance with Cooper Wheelock Inc., dba Cooper Notification standard terms and conditions.

Architects and Engineers Specifications

The notification appliances shall be Wheelock® Exceder™ Series HS Audible Strobe appliances, Series ST Visual Strobe appliances and Series HN Audible appliances or approved equals. The Series HS and ST Strobes shall be listed for UL Standard 1971 (Emergency Devices for the Hearing-Impaired) for Indoor Fire Protection Service. The Series HS and HNAudibles shall be UL Listed under Standard 464 (Fire Protective Signaling). All Series shall meet the requirements of FCC Part 15 Class B. All inputs shall be compatible with standard reverse polarity supervision of circuit wiring by a Fire Alarm Control Panel (FACP) with the ability to operate from 8 to 33 VDC. Indoor wall models shall incorporate voltage test points for easy voltage inspection.

The Series HS Audible Strobe and ST Strobe appliances shall produce a flash rate of one (1) flash per second over the Regulated Voltage Range and shall incorporate a Xenon flashtube enclosed in a rugged Lexan® lens. The Series shall be of low current design. Where Multi-Candela appliances are specified, the strobe intensity shall have 8 field selectable settings at 15, 15/75, 30, 75, 95, 110, 135, 185 candela for wall mount and 15, 30, 60, 75, 95, 115, 150, 177 candela for ceiling mount. The selector switch for selecting the candela shall be tamper resistant. The 15/75 candela strobe shall be specified when 15 candela UL Standard 1971 Listing with 75 candela on-axis is required (e.g. ADA compliance). Appliances with candela settings shall show the candela selection in a visible location at all times when installed.

The audible shall have a minimum of three (3) field selectable settings for dBA levels and shall have a choice of continuous or temporal (Code 3) audible outputs.

The Series HS Audible Strobe, ST Strobe and Series HN Audible shall incorporate a patented Universal Mounting Base that shall allow mounting to a single-gang, double-gang, 4-inch square, 3.5-inch octal, 4-inch octal or 100mm European type back boxes. Two wire appliance wiring shall be capable of directly connecting to the mounting base. Continuity checking of the entire NAC circuit prior to attaching any notification appliances shall be allowed. Product shall come with Contact Cover to protect contact springs. Removal of an appliance shall result in a supervision fault condition by the Fire Alarm Control Panel (FACP). The mounting base shall be the same base among all horn, strobe, horn strobe, wall and ceiling models. All notification appliances shall be backwards compatible.

The Series HS and ST wall models shall have a low profile measuring 5.24" H x 4.58" W x 2.19" D. Series HN wall shall measure 5.24" H x 4.58" W x 1.6" D. The Series HSC and STC shall be round and have a low profile with a diameter of 6.68" x 2.63" D. Series HNC ceiling shall have a diameter of 6.68" x 1.50" D.

When synchronization is required, the appliance shall be compatible with Wheelock®'s SM, DSM Sync Modules, Wheelock® Power Supplies or other manufacturer's panels with built-in Wheelock® Patented Sync Protocol. The strobes shall not drift out of synchronization at any time during operation. If the sync protocol fails to operate, the strobe shall revert to a non-synchronized flash-rate and still maintain (1) flash per second over its Regulated Voltage Range. The appliance shall also be designed so that the audible signal may be silenced while maintaining strobe activation when used with Wheelock® synchronization protocol.

Wall Appliances – UL Standard 1971, UL Standard 464, California State Fire Marshal (CSFM), ULC

Ceiling Appliances – UL Standard 1971, UL Standard 464, California State Fire Marshal (CSFM), ULC



WE ENCOURAGE AND SUPPORT NICET CERTIFICATION
3 YEAR WARRANTY

Exceder - Spec Sheet 11/09

NJ Location
273 Branchport Ave.
Long Branch, NJ 07740
P: 800-631-2148
F: 732-222-8707
www.coopernotification.com

FL Location
7565 Commerce Ct.
Sarasota, FL 34243
P: 941-487-2300
F: 941-487-2389

VA Location
4401 Wilson Boulevard, Suite 220
Arlington, VA 22203
P: 877-459-7726
F: 703-294-6560

Cooper Notification is

Wheelock®



SAFEPATH®

WAVES



COOPERNotification

→ 7750F



RF Subscriber Unit

UL Fire and AA Burglary Listed

NFPA-72 Compliant

UL Listed

UL Listed Central station

Remote Station

864,827,1610,365,681

CSFM

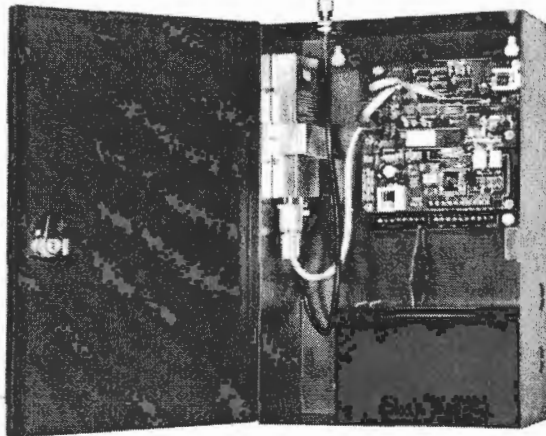

Advanced Wireless Alarm Monitoring

The 7750-F smart subscriber unit links an alarm panel to an alarm monitoring central station. This 2-way transceiver and repeater in one is housed in a full size locking steel cabinet for superior performance. The 7750-F supports a wide range of inputs such as NO/NC/EOL and direct voltage. It automatically senses phone line cuts and antenna cuts, and monitors battery and AC power status. Advanced status reporting, self-diagnostics and a built-in power supply make the 7750-F the first choice for all wireless alarm communication needs.

Full Data for Fire and Burglary

Use with the optional FireTap for full fire data or the IntelliTap for full burglary data.

Available Configurations

7750 F 4x4 – 4 reversing polarity inputs plus 4 programmable EOL inputs

→ **7750 F 8** – 8 programmable EOL inputs

Available Options

FireTap 7768
IntelliTap 7067
NEMA 4 Enclosure
High Gain Antenna
Back Up Battery
Available in Burglary Beige or Fire Red

- UL Listed (Fire & AA Burglary)
- NFPA-72 Compliant
- 864, 827,1610,365, 681
- Options for Full Data for Fire and Burglary
- Available in 4 & 8 Zone Configurations
- Built-in Power Supply and Battery Charger

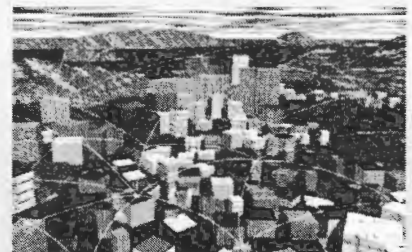

Wireless mesh networking is an innovative technology adopted by many industries with applications that need to communicate data over a large geographic area with a high level of reliability at a low total cost of ownership.

The advanced design and 2-way communications capability provides easy installation, expansion, and management when compared to alternative communication methods, both wired and wireless.

7750F RF Subscriber Unit

Technical Specifications

Radio

Standard CSAA frequency ranges: 450-470 MHz and 130-174 MHz, VHF and UHF. Others available

Standard Output Power

2 watts (requires FCC license)

Power Input

16.5 VAC, 40VA UL listed
Class II transformer required

Voltage

12 VDC nominal

Current

175mA standby; 800mA transmit

Alarm Signal Inputs

- 4 individually programmable
Zones: NO/NC/EOL, trouble
restore
- RS-232

Operating Temperature Range

0° to 50°C, 32° to 122°F

Storage Temperature Range

-10° to 60°C, 14° to 140°F

Relative Humidity Range

0-85% RHC non-condensing

Back up Battery

12V, 7 AH option

Low Battery Reporting

22.5-minute test cycle

AC Status

Reports to central station after approximately 4 minutes without AC power, reports power restored after approximately 4 minutes of restored power

Antenna Cut (local reporting)

12 VDC signal output at output J4, 200 mA max load

Open Collector Output

200mA maximum load

Size

13.25"H x 8.5"W x 4.3"D
34cm x 21.5cm x 11cm

Weight

6.4 lbs, 2.9 Kilograms
(excluding battery)

Colors

Available in standard
Burglary Beige or Fire Red
Please specify when ordering

Available Options

- 7750F-8 RF subscriber unit
with 8 EOL inputs
- 7750F-4x4 RF subscriber unit
with 4 EOL inputs and 4 reverse
polarity inputs
- 7768 - FireTap
- 7067 - IntelliTap

Please specify when ordering

Available configurations

- 4 EOL Inputs
- 8 EOL inputs
- 4 EOL inputs w/4 reverse
polarity inputs
- NEMA 4 Enclosure

AES-IntelliNet™ is the industry leader in delivering high quality wireless mesh networks to the fire and security industry in commercial, corporate, government, and educational applications with its broad line of products and advanced network management tools. Users of AES-IntelliNet networks have gained significant revenue, communications, and cost advantages while meeting the high standards of reliability required for the fire and security industry. AES-IntelliNet alarm monitoring systems are deployed at hundreds of thousands of locations in over 130 countries.



For more information

Call 800-AES-NETS (800-237-6387)

AES Corporation | 285 Newbury Street | Peabody, MA 01960 USA

Tel. +1 978-535-7310 | Fax +1 978-535-7313 | Email info@aes-intellinet.com

Web www.aes-intellinet.com

Copyright 2004 AES Corp.
AES-IntelliNet is a registered trademark of AES Corp.

7750F/12/04/R1

→ NC-100R(A)

Relay Module for FireWarden Series Panels

 **NOTIFIER**[®]
by Honeywell

Addressable

General

The NC-100R(A) Addressable Relay Module provides NOTIFIER's FireWarden Series intelligent control panels with two isolated sets of Form-C dry-contact outputs for activating a variety of auxiliary devices, such as fans, dampers, door holders, control equipment, etc. Addressability allows the dry contact to be activated, either manually or through panel programming, on a select basis.

Features

- Built-in type identification automatically identifies these devices to the control panel.
- Internal circuitry and relay powered directly by two-wire SLC loop.
- Integral LED "blinks" green each time a communication is received from the control panel and turns on in steady when activated.
- High noise immunity (EMF/RFI).
- Wide viewing angle of LED.
- SEMS screws with clamping plates for wiring ease.
- Direct Decade entry of address: 01 – 99 with the FireWarden-100-2(C) and 01 – 50 with the FireWarden-50(C).

Applications

The NC-100R(A) may be programmed to operate dry contacts for door holders, Air Handling Unit shutdown, etc., and to reset four-wire smoke detector power.

Construction

- The face plate is made of off-white heat-resistant plastic.
- Controls include two rotary switches for direct-dial entry of address setting.
- The NC-100R(A) provides two Form-C dry contacts that switch together.

Operation

Each NC-100R(A) uses one of the addresses on a SLC loop. It responds to regular polls from the control panel and reports its type and status. The LED blinks with each poll received. On command, it activates its internal relay.

Rotary switches set a unique address for each module. The address may be set before or after mounting. The built-in TYPE CODE (not settable) will identify the module to the control panel.

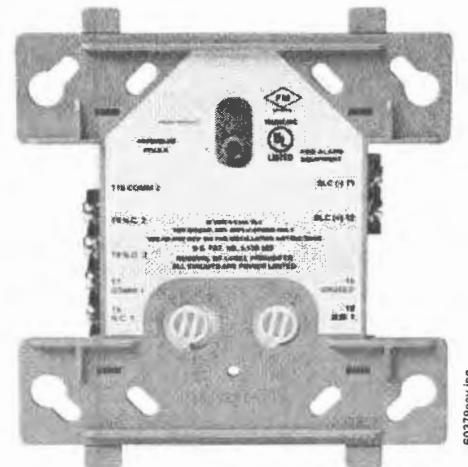

NC-100R(A)

Specifications

Normal operating voltage: 15 to 32 VDC.

Maximum SLC current draw: 6.5 mA (LED).

Average operating current: 230 μ A direct poll (CLIP mode), 255 μ A group poll with LED flashing.

EOL resistance: not used.

Temperature range: 32°F to 120°F (0°C to 49°C).

Humidity range: 10% to 93% non-condensing.

Dimensions: 4.5" (11.43 cm) high x 4" (10.16 cm) wide x 1.25" (3.175 cm) deep. Mounts to a 4" (10.16 cm) square x 2.125" (5.398 mm) deep box.

Relay Contact Ratings

Load Description	Application	Maximum Voltage	Current Rating
Resistive	Non-Coded	30 VDC	3.0 A
Resistive	Coded	30 VDC	2.0 A
Resistive	Non-Coded	110 VDC	0.9 A
Resistive	Non-Coded	125 VAC	0.9 A
Inductive (L/R=5ms)	Coded	30 VDC	0.5 A
Inductive (L/R=2ms)	Coded	30 VDC	1.0 A
Inductive (PF=0.35)	Non-Coded	125 VAC	0.5 A

Agency Listings and Approvals

In some cases, certain modules may not be listed by certain approval agencies, or listing may be in process. Consult factory for latest listing status.

- **UL/ULC Listed:** S635.
- **CSFM approved:** file 7300-0028:230.
- **FM approved.**
- **MEA approved:** file 72-01-E, Vol. 2.

Product Line Information

➔ **NC-100R:** Intelligent addressable relay module.

NC-100RA: Intelligent addressable relay module, ULC listed model.

SMB500: Optional surface-mount backbox.

NOTE: For installation instructions, see document 156-2593-001 and refer to the SLC Wiring Manual, document 52304.

NOTIFIER® is a registered trademark of Honeywell International Inc.
©2010 by Honeywell International Inc. All rights reserved. Unauthorized use of this document is strictly prohibited.



This document is not intended to be used for installation purposes.
We try to keep our product information up-to-date and accurate.
We cannot cover all specific applications or anticipate all requirements.
All specifications are subject to change without notice.



Made in the U.S. A.

For more information, contact Notifier. Phone: (203) 484-7161, FAX: (203) 484-7118.
www.notifier.com

High Security Commercial Key Vault

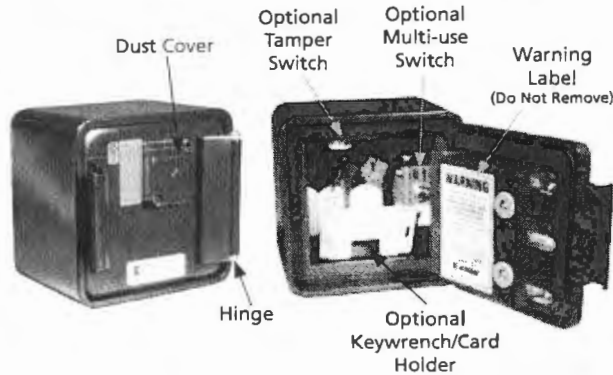

A new Knox-Box that's for those applications where a 3200 Series is too small yet the 4400 Series too large. The high security 4100 Series has a hinged-door allowing for the convenient single-handed operation. The 4100 Series Knox-Vault protects and stores building keys, access cards and the Knox FDC Keywrench allowing departments to keep a keywrench on site.

Features and Benefits

- Holds up to 24 keys in the large interior compartment
- Ensures high security with UL listed Medeco lock(s)
- Includes Knox-Coat® that is four times better than standard powder coat
- Resists moist conditions with a weather resistant silicone door gasket
- Colors: Black, Dark Bronze or Aluminum
- Weight: Surface mount - 17 lbs.
Recessed mount - 19 lbs.

Options

- Alarm Tamper Switches (U/L listed)
- Recessed Mounting Kit (RMK) for recessed models only
- Dual lock configuration
- Access card holder
- Keywrench holder

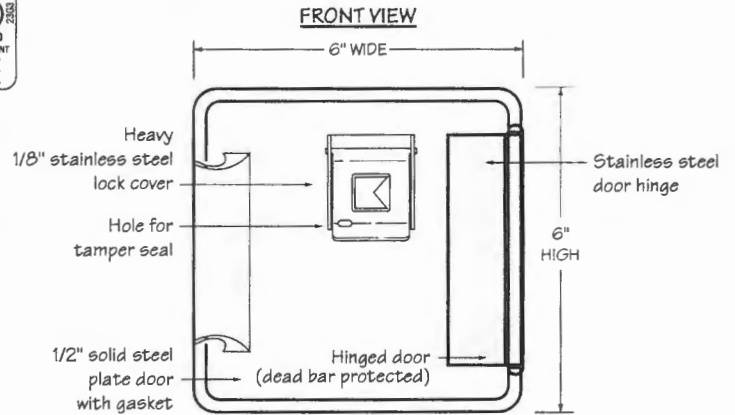

4100 Surface Mount

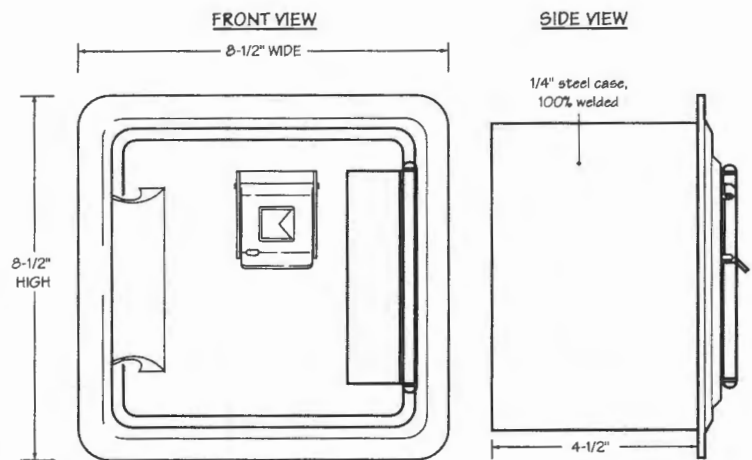

4100 Recessed Mount

Ordering Specifications

To ensure procurement and delivery of the 4100 Series Knox-Vault, it is suggested that the following specification paragraph be used:

KNOX-VAULT surface/recessed mount, with/without UL Listed tamper switches. 1/4" plate steel housing, 1/2" thick solid steel door with interior silicone gasket seal. Lock UL listed. Lock has 1/8" thick stainless steel dust cover with tamper seal mounting capability. Vault has anti-theft re-locking mechanism with drill resistant hard-plate lock protector.

Exterior Dimensions: Surface mount – 6"H x 6"W x 4 1/2"D
Recessed mount – 8 1/2"H x 8 1/2"W x 4 1/2"D

Lock: UL Listed. Double-action rotating tumblers and hardened steel pins accessed by a proprietary coded biased cut key.

Finish: Knox-Coat® proprietary finishing process
Finish Color - Black, Dark Bronze or Aluminum

P/N: 4100 Series Knox-Vault (mfr's cat. ID)

Mfr's Name: **KNOX COMPANY**



System Current Draw - NFW-50

Current Draw	
C1	0.126 A
C2	2.211 A
C3	0.126 A
C4	2.211 A

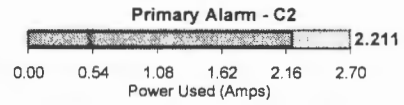
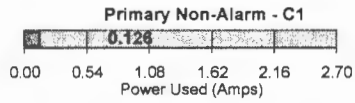

Device	C1 - Primary Non-Alarm				C2 - Primary Alarm				C3 - Secondary Non-Alarm					
	Qty		Draw	Total	Qty		Draw	Total	Qty		Draw	Total		
Main Circuit Board	1	x	0.12000	0.12000	1	x	0.20000	0.20000	1	x	0.12000	0.12000		
HSR15	2	x	0.00000	0.00000	2	x	0.08200	0.16400	2	x	0.00000	0.00000		
HSR30	5	x	0.00000	0.00000	5	x	0.10200	0.51000	5	x	0.00000	0.00000		
STR15	15	x	0.00000	0.00000	15	x	0.05700	0.85500	15	x	0.00000	0.00000		
HSRC15	1	x	0.00000	0.00000	1	x	0.08200	0.08200	1	x	0.00000	0.00000		
NP-100	4	x	0.00030	0.00120					4	x	0.00030	0.00120		
NH-100	4	x	0.00030	0.00120					4	x	0.00030	0.00120		
NMM-100	2	x	0.00040	0.00080					2	x	0.00040	0.00080		
NMM-100P	4	x	0.000375	0.00150					4	x	0.000375	0.00150		
NOT-BG12LX	3	x	0.00023	0.00069					3	x	0.00023	0.00069		
NC-100R	2	x	0.00027	0.00054					2	x	0.00027	0.00054		
Max Alarm Draw - All Addressable Devices					1	x	0.40000	0.40000						
Total Non-Alarm Load:				0.126	Total Alarm Load:				2.211	Total Standby Load:				0.126



System Power Requirements

NFW-50 Fire Alarm Control Panel

Protected Premises: <u>Cport Credit Union</u>	Date: <u>2/8/2012</u>
Address: _____	
City: <u>Portland</u>	State: <u>Maine</u> Zip: _____
Prepared By: <u>Norris Inc</u> Phone: <u>2/8/12</u>	
Address: <u>2257 West Broadway</u> Email: _____	
City: <u>South Portland</u>	State: <u>Maine</u> Zip: _____

AC Branch Current Requirements 3.00 AMPS @ 120 VAC

Current required by source to power the fire alarm system.

Primary Standby Load 0.13 Amps

Current load on the primary power supply during non-alarm conditions.

Primary Alarm Load 2.21 Amps

Current load on the primary power supply during alarm conditions.

Secondary Load Requirements 9.51 Amp Hours

Total Secondary Load from the calculation table below.

Current Draw		Time (hours)	Total (AH)
Secondary Standby Load 0.126 A	x	Required Standby Time	
		60 hours	7.56
Secondary Alarm Load 2.211 A	x	Required Alarm Time	
		0.167 hours	0.37
Total Secondary Load			7.93
Derating factor			x 1.2
Secondary Load Requirements			9.51

AH

Battery Selection 12 Amp Hours

Select batteries from the list below.

12 AH BAT-12120 Battery (12 volt)

- Two Four (two 12VDC sets in parallel)

Battery Distribution Chart

Shows amp-hour distribution of your selections.

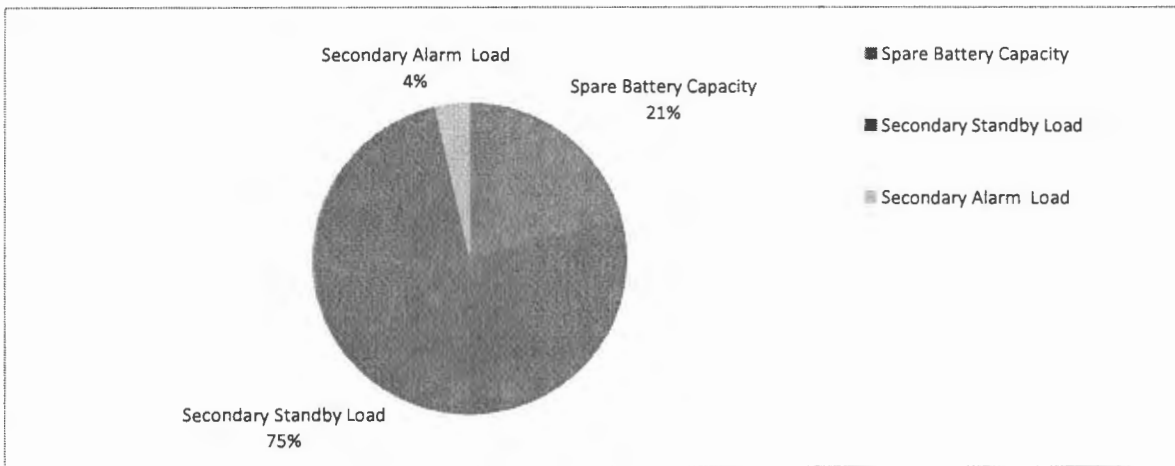

Comments

1. Batteries will fit in the FACP cabinet.
2. Selected battery size meets secondary load requirements.
3. The selected batteries (12AH) are within the charger range of this power supply (7-18AH).

Spare Battery Capacity	2.49	Battery Selection (AH) - Secondary Load Requirements (AH)
Secondary Standby Load	9.07	Secondary Standby Load (AH) * Derating Factor
Secondary Alarm Load	0.44	Secondary Alarm Load (AH) * Derating Factor

Important! Securing Screws MUST be installed in top of Device on Exceder series HSR and STR Audio Visuals.

Important! Wiring connections must have correct polarity.

LEGEND

- MOUNTING HEIGHT
- 48 INCHES
 - PS PULL STATION
 - S SMOKE DETECTOR
 - R HEAT DETECTOR RATE OF RISE
 - F HEAT DETECTOR FIXED TEMP
 - RT REMOTE TEST/INDICATOR
 - DS DUCT SMOKE DETECTOR
 - 60 INCHES
 - VD VISUAL ONLY
 - 80 INCHES
 - AV AUDIO / VISUAL
 - AV AV AUDIO / VISUAL CEILING MOUNT
 - NC-100 CONTROL MODULE
 - NMH-100 MONITOR MODULE 100-4 SQUARE, 100mmx100mm
 - NC-100P RELAY MODULE
 - STS SPRINKLER TAMPER
 - SFS SPRINKLER FLOW

This drawing is an accurate layout from provided floor plans and information available at time of design. Circuited has been designed for maximum use of resources available with supplied equipment. Deviations from this design must be noted and approved prior to final acceptance. Note: There are 2 signal circuits have a combined load limitation of 2.5 amps. REMOTE power supply has a 3.0 amps limitation per circuit and an 8.0 amp combined limitation for all A circuits. Changes in circuiting must incorporate equipment specifications/limitations (see chart below for current vs. candle rating. Distances and ratings shown are for wall applications ONLY, call Morris, Inc. for ceiling devices when applicable.) Twisted-Unshielded Cable is NOT recommended for SLC wiring for this panel. Unshielded-Unshielded cable has a 2500' maximum distance either inside or outside conduit sizes 12-18AWG

Room Size	Candle Rating	Load (amps)
20' x 20'	15 cd	0.00 amps
20' x 20'	30 cd	0.10 amps
45' x 45'	75 cd	0.15 amps
54' x 54'	110 cd	0.20 amps

- 4.7k END OF LINE RESISTOR (Panel Circuits)
- A 1 PR #12 AWG TWISTED-PAIR CABLE FPL GENESIS WG-4315
 - 1 WG-4315 BELDEN 5020UL 66200UL (Up to 10,000 Ft)
 - A 1 PR #14 AWG TWISTED-PAIR CABLE FPL GENESIS WG-4319
 - 1 WG-4319 BELDEN 5020UL 61000UL (Up to 9,000 Ft)
 - A 1 PR #16 AWG TWISTED-PAIR CABLE FPL GENESIS WG-4311
 - 1 WG-4311 BELDEN 5020UL 66200UL (Up to 4,500 Ft)
 - B 1 PR #12 AWG FPL CABLE
 - D 1 PR #14 AWG FPL CABLE
 - E 1 PR #16 AWG FPL CABLE
 - F 2c #12 AWG CABLE
 - G 2c #14 AWG CABLE
 - H 2c #16 AWG CABLE
 - J 1 CAT5 CABLE

REVISION 2	DATE:
REVISION 1	DATE:
REVISION 0 SUBMITTAL	DATE: 2/07/12

SYSTEM WIRING RISER	
PROJECT NAME	SCALE NTS
CPORT CREDIT UNION	BY: QJD
PORTLAND, MAINE	CK BY:
 Prepared For Reference: Delivered To: 2257 BROADWAY, 3RD FLOOR, PORTLAND, MAINE	
SAVED AS:	

Important! Duplicate Addresses on devices of different style is NOT allowed on this panel. All electronic devices MUST be placed in a heated room with temperature above 32 degrees. Never run wires parallel to any other wiring. Make sure to always run cables in separate raceways. Fire alarm wiring can emit noise that may affect other devices. Shielded cable can be used if cable is run near sensitive equipment.

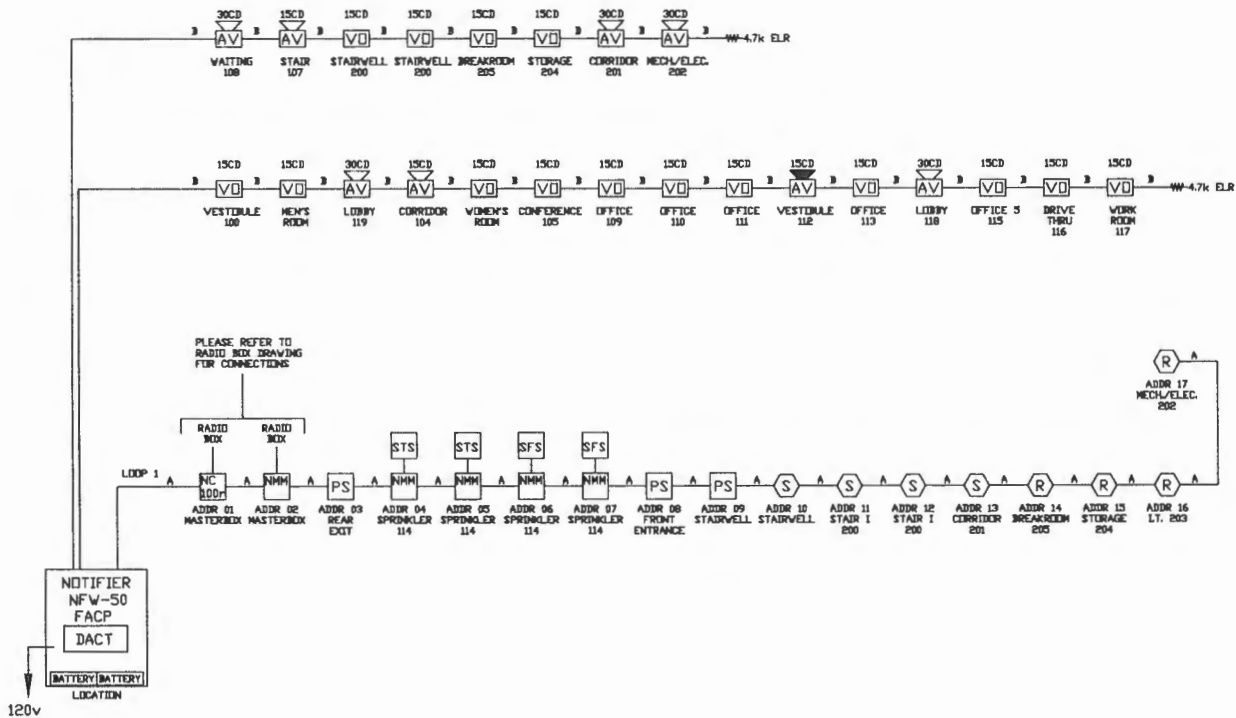

PLEASE REFER TO RADIO BOX DRAWING FOR CONNECTIONS

LOOP 1

ADDR 17 MECH/ELEC. 202

120V

REVISION 2	DATE:
REVISION 1	DATE:
REVISION 0 SUBMITTAL	DATE: 2/08/12
SYSTEM WIRING RISER	
PROJECT NAME CPORT CREDIT UNION MATRIX PORTLAND, MAINE	SCALE: NTS BY: C.JC CK BY:
 NORRIS INC <small>Prepared For Tomorrow, Delivered Today</small>	SAVED AS:
	2257 W BROADWAY, SO PORTLAND, MAINE 04106

SYSTEM INPUTS	CONTROL UNIT ACTIVATION								NOTIFICATION								REQUIRED FIRE SAFETY CONTROL			
	A	B	C	D	E	F	G	H	I	J	K	L	M	N	O	P	Q	U	V	
1 MANUAL FIRE ALARM PULL STATION	●	●					●	●	●		●									1
2 AREA SMOKE DETECTOR	●	●					●	●	●		●									2
3 AREA HEAT DETECTOR	●	●					●	●	●		●									3
4 SPRINKLER WATERFLOW	●	●					●	●	●		●									4
5 SPRINKLER TAMPER SWITCH			●	●			●	●				●								5
6 FIRE ALARM AC POWER FAILURE					●	●	●	●					●							6
7 FIRE ALARM SYSTEM LOW BATTERY					●	●	●	●					●							7
8 OPEN CIRCUIT					●	●	●	●					●							8
9 GROUND FAULT					●	●	●	●					●							9
10 NOTIFICATION APPLIANCE CIRCUIT SHORT					●	●	●	●					●							10
11																				11
12																				12
13																				13
14																				14
15																				15
16																				16
17																				17
18																				18
19																				19
20																				20
21																				21

This drawing is a typical set up for a AES box that only requires one zone.

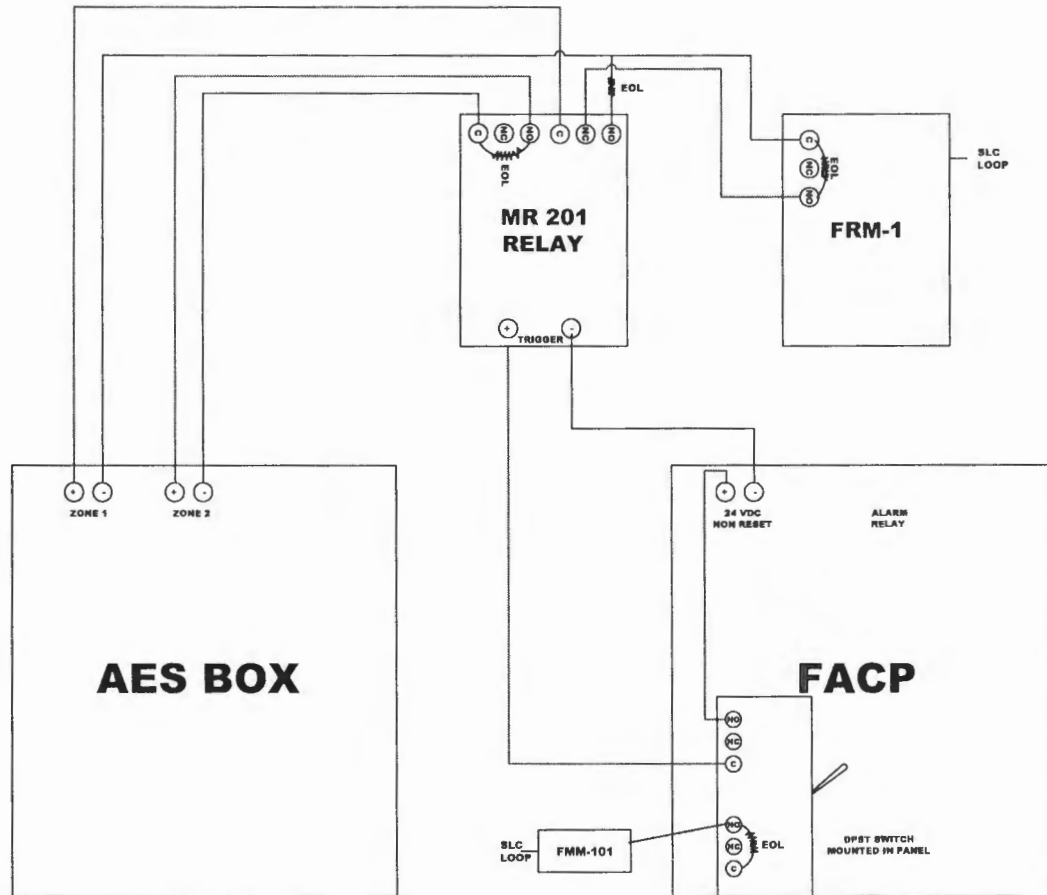

SYMBOL LEGEND

REVISION 2	DATE:
REVISION 1	DATE:
REVISION 0 SUBMITTAL	DATE: 2-08-2012

SYSTEM WIRING RISER

PROJECT NAME Typical Portland, MAINE	SCALE NTS BY: GJC CK BY:
---	---------------------------------------

NORRIS INC Provided For Designer's Information Only 2257 BROADWAY, SOUTH PORTLAND, MAINE	SAVED AS:
---	-----------