

DISPLAY THIS CARD ON PRINCIPAL FRONTAGE OF WORK
CITY OF PORTLAND

Please Read Application And Notes, If Any, Attached

BUILDING INSPECTION PERMIT

Permit Number: 091416
PERMIT ISSUED

This is to certify that Forest Avenue Plaza Llc/Protection One
has permission to Install fire alarm system DEC 16 2009
AT 449 Forest Ave CBL 111 A016002

provided that the person or persons, firm or corporation accepting this permit shall comply with all of the provisions of the Statutes of Maine and of the Ordinances of the City of Portland regulating the construction, maintenance and use of buildings and structures, and of the application on file in this department.

Apply to Public Works for street line and grade if nature of work requires such information.

Notification of inspection must be given and written permission procured before this building or part thereof is lathed or otherwise closed-in. 24 HOUR NOTICE IS REQUIRED.

A certificate of occupancy must be procured by owner before this building or part thereof is occupied.

OTHER REQUIRED APPROVALS

Fire Dept. [Signature] (202)
Health Dept. _____
Appeal Board _____
Other _____
Department Name _____

[Signature] 12/16/09
Director - Building & Inspection Services

PENALTY FOR REMOVING THIS CARD

City of Portland, Maine - Building or Use Permit Application

389 Congress Street, 04101 Tel: (207) 874-8703, Fax: (207) 874-8716

Permit No: 09-1416	Issue Date:	CBL: 111 A016002
-----------------------	-------------	---------------------

Location of Construction: 449 Forest Ave	Owner Name: Forest Avenue Plaza Llc	Owner Address: 715 Boylston St	Phone:
Business Name:	Contractor Name: Protection One	Contractor Address: 10 Manuel Drive Portland	Phone: 2073475316
Lessee/Buyer's Name	Phone:	Permit Type: Fire Alarm System	Zone: B-2b

Past Use: Commercial	Proposed Use: Commercial / Install fire alarm system	Permit Fee: \$320.00	Cost of Work: \$13,085.00	CEO District: 1
		FIRE DEPT: w/conditions 12/16/09 <input checked="" type="checkbox"/> Approved <input type="checkbox"/> Denied	INSPECTION: Use Group: M/B Type: Fire alarm IBC-2003 Signature: M/B 12/16/09	

Proposed Project Description:
Install fire alarm system

Signature: [Signature] Signature: [Signature]

PEDESTRIAN ACTIVITIES DISTRICT (P.A.S.D.)
Action: Approved Approved w/Conditions Denied
Signature: _____ Date: _____

Permit Taken By: gg	Date Applied For: 12/15/2009	Zoning Approval	
------------------------	---------------------------------	------------------------	--

<ol style="list-style-type: none"> This permit application does not preclude the Applicant(s) from meeting applicable State and Federal Rules. Building permits do not include plumbing, septic or electrical work. Building permits are void if work is not started within six (6) months of the date of issuance. False information may invalidate a building permit and stop all work.. 	Special Zone or Reviews <input type="checkbox"/> Shoreland <input type="checkbox"/> Wetland <input type="checkbox"/> Flood Zone <input type="checkbox"/> Subdivision <input type="checkbox"/> Site Plan Maj <input type="checkbox"/> Minor <input type="checkbox"/> MM <input type="checkbox"/> Date: 12/16/09 [Signature]	Zoning Appeal <input type="checkbox"/> Variance <input type="checkbox"/> Miscellaneous <input type="checkbox"/> Conditional Use <input type="checkbox"/> Interpretation <input type="checkbox"/> Approved <input type="checkbox"/> Denied Date: [Signature]	Historic Preservation <input checked="" type="checkbox"/> Not in District or Landmark <input type="checkbox"/> Does Not Require Review <input type="checkbox"/> Requires Review <input type="checkbox"/> Approved <input type="checkbox"/> Approved w/Conditions <input type="checkbox"/> Denied Date: [Signature]
---	--	---	--

PERMIT ISSUED

DEC 16 2009

City of Portland

CERTIFICATION

I hereby certify that I am the owner of record of the named property, or that the proposed work is authorized by the owner of record and that I have been authorized by the owner to make this application as his authorized agent and I agree to conform to all applicable laws of this jurisdiction. In addition, if a permit for work described in the application is issued, I certify that the code official's authorized representative shall have the authority to enter all areas covered by such permit at any reasonable hour to enforce the provision of the code(s) applicable to such permit.

SIGNATURE OF APPLICANT	ADDRESS	DATE	PHONE
RESPONSIBLE PERSON IN CHARGE OF WORK, TITLE		DATE	PHONE

City of Portland, Maine - Building or Use Permit

389 Congress Street, 04101 Tel: (207) 874-8703, Fax: (207) 874-8716

Permit No: 09-1416	Date Applied For: 12/15/2009	CBL: 111 A016002
-----------------------	---------------------------------	---------------------

Location of Construction: 449 Forest Ave	Owner Name: Forest Avenue Plaza Llc	Owner Address: 715 Boylston St	Phone:
Business Name:	Contractor Name: Protection One	Contractor Address: 10 Manuel Drive Portland	Phone: (207) 347-5316
Lessee/Buyer's Name	Phone:	Permit Type: Fire Alarm System	

Proposed Use: Commercial / Install fire alarm system	Proposed Project Description: Install fire alarm system
--	---

Dept: Zoning	Status: Approved	Reviewer: Ann Machado	Approval Date: 12/16/2009
Note:			Ok to Issue: <input checked="" type="checkbox"/>
1) This permit is being approved on the basis of plans submitted. Any deviations shall require a separate approval before starting that work.			
Dept: Building	Status: Approved with Conditions	Reviewer: Jeanine Bourke	Approval Date: 12/16/2009
Note:			Ok to Issue: <input checked="" type="checkbox"/>
1) Fire Alarm systems shall be installed per Sec. 907 of the IBC 2003			
Dept: Fire	Status: Approved with Conditions	Reviewer: Ben Wallace Jr.	Approval Date: 12/16/2009
Note:			Ok to Issue: <input checked="" type="checkbox"/>
1) Fire alarm system requires a Masterbox connection per city ordinance. Masterbox design and installation shall be as approved by City Electrical Division.			
2) The fire alarm system shall comply with the City of Portland Standard for Signaling Systems for the Protection of Life and Property. All fire alarm installation and servicing companies shall have a Certificate of Fitness from the Fire Department.			
3) Installation of a Fire Alarm system requires a Knox Box to be installed per city ordinance			
4) System acceptance and commissioning must be co-ordinated with alarm and suppression system contractors and the Fire Department. Call 874-8703 to schedule.			
5) All fire alarm records required by NFPA 72 should be stored in an approved cabinet located at the FACP and keyed alike, labeled "FIRE ALARM RECORDS".			

PERMIT ISSUED

DEC 16 2009

City of Portland

mail to PROTECTION ONE
10 MANUEL DR
PORTLAND, ME 04103



Fire Alarm Permit

If you or the property owner owes real estate or property taxes or user charges on any property within the city, payment arrangements must be made before permits of any kind are accepted.

Installation address: 449 Forest Avenue CBL: 111 A 016002

Exact location: (within structure) Center of Plaza at 449 Forest Avenue

Type of occupancy(s) (NFPA & ICC): Business

Building owner: Forest Avenue Associates

Must be System Designer (point of contact): Robin Russell

Designer phone: (207) 347-5327 E-mail: rrussell@protectionone.com

Installing contractor: Protection One Certificate of Fitness No: _____

Contractor phone: John Kempton E-mail: jkempton@protectionone.com

This is a new application: YES NO

This is an amendment to an existing permit: YES NO Permit no: _____

The following documents shall be provided with this application:

- Floor plans
- Wiring diagram
- Annunciator details
- Equipment data sheets
- Battery & voltage drop calculations
- Input/ Output Matrix
- Designer qualifications
- Electrical Permit Pulled (check comm/alarm)

COST OF WORK: \$ 13,085.

PERMIT FEE: 160,00
(\$10 PER \$1,000 + \$30 FOR THE FIRST \$1,000)

RECEIVED

DEC 15 2009

Dept. of Building Inspections
City of Portland Maine

The designer shall be the responsible party for this application. Download a new copy of this application at www.portlandmaine.gov/fire for every submittal. Submit all plans on 11X17 copies or electronic PDF's in addition to full sized plans to the Building Inspections Department, 389 Congress Street, Room 315, Portland, Maine 04101.

Prior to acceptance of any fire alarm system, a complete commissioning and acceptance test must be coordinated with all fire system contractors and the Fire Department, and proper documentation of such test(s) provided.

All installation(s) must comply with the *City of Portland Technical Standard for Signaling Systems for the Protection of Life and Property*, available at www.portlandmaine.gov/fire.

Applicant signature: Robin Russell Date: 12/15/09

NATIONAL INSTITUTE FOR CERTIFICATION IN ENGINEERING TECHNOLOGIES®

HEREBY CERTIFIES THAT

Robin L. Russell

HAS ATTAINED THE GRADE OF

LEVEL II

IN FIRE PROTECTION ENGINEERING TECHNOLOGY
FIRE ALARM SYSTEMS

AND RECOGNIZES THAT THROUGH EDUCATION,
EXPERIENCE, AND KNOWLEDGE THIS PERSON HAS
MET THE STANDARDS SET FORTH BY THIS INSTITUTE

Certification Valid through April 1, 2010

CERTIFICATION NUMBER 110826



CHAIRMAN OF THE BOARD OF GOVERNORS, NICET



SPONSORED BY THE NATIONAL SOCIETY OF PROFESSIONAL ENGINEERS

Jobsite Information: _____

FCPS-24FS6 / 8 Battery Calculation

Entries only to be made in the Yellow cell locations

Regulated Load in Standby

Device Type	Number of Devices		Current (Amps)		Total Current (Amps)
Main PC Board	1	X	0.065	=	0.065
Power Supervision Relays	1	X	0.025	=	0.025
Auxiliary Current Draw from TB4 Terminals 9 & 10		X		=	0
STANDBY LOAD =					0.09

Regulated Load in ALARM

Device Type	Number of Devices		Current (Amps)		Total Current (Amps)
Main PC Board without AC	1	X	0.145	=	0.145
Power Supervision Relays		X	0.025	=	0
Auxiliary Current Draw from TB4 Terminals 9 & 10		X		=	0
NAC / Output # 1	8	X	0.293	=	2.344
NAC / Output # 2	9	X	0.101	=	0.909
NAC / Output # 3	8	X	0.293	=	2.344
NAC / Output # 4		X		=	0
ALARM LOAD =					5.742

Battery Amp Hour Calculation

Standby Load Current (Amps)	0.09	X	Required Standby Time (Typically 24 or 60 Hours)	24 =	2.16 AH
Alarm Load Current (Amps)	5.742	X	Required Alarm Time (Typically 5 or 10 Minutes)	10 =	0.96 AH
Sub Total Standby / Alarm Amp Hours					3.12 AH
Multiply by the Derating Factor					X 1.2 *
Total Ampere Hours Required =					4 AH

* Derating Factor required to compensate for the non-linear discharge characteristic of a battery.

MS-9200UDLS Rev.2 Battery Calculation

Secondary Power Source Requirements

Device Type	Standby Current (amps)				Secondary Alarm Current (amps)			
	Qty		Current Draw	Total	Qty		Current Draw	Total
Main Circuit Board	1	x	0.137000	= 0.137000	1	x	0.360000	= 0.360000
XRM-24B	0	x	0.000000	=	0	x	0.000000	=
4XTMF	0	x	0.005000	=	0	x	0.011000	=
IPDACT	0	x	0.100000	=	0	x	0.300000	=
IPDACT-2/2UD	0	x	0.098000	=	0	x	0.155000	=
ANN-BUS Devices								
ANN-80(-W)	0	x	0.015000	=	0	x	0.040000	=
ANN-LED	0	x	0.028000	=	0	x	0.068000	=
ANN-RLED	0	x	0.028000	=	0	x	0.068000	=
ANN-RLY	0	x	0.015000	=	0	x	0.075000	=
ANN-I/O	0	x	0.035000	=	0	x	0.200000	=
ANN-S/PG	0	x	0.045000	=	0	x	0.045000	=
ACS Annunciators								
ACM-8RF	0	x	0.030000	=	0	x	0.158000	=
ACM-16ATF	0	x	0.040000	=	0	x	0.056000	=
ACM-32AF	0	x	0.040000	=	0	x	0.056000	=
AEM-16ATF	0	x	0.002000	=	0	x	0.018000	=
AEM-32AF	0	x	0.002000	=	0	x	0.018000	=
AFM-16ATF	0	x	0.040000	=	0	x	0.056000	=
AFM-32AF	0	x	0.040000	=	0	x	0.056000	=
AFM-16AF	0	x	0.025000	=	0	x	0.065000	=
LDM-32F	0	x	0.040000	=	0	x	0.056000	=
LDM-E32F	0	x	0.002000	=	0	x	0.018000	=
LCD-80F	0	x	0.025000	=	0	x	0.064000	=
Resettable Power								
4-Wire Smoke Detectors	0	x	0.000000	=	0	x	0.000000	=
Addressable Devices								
BEAM355	0	x	0.002000	=				
BEAM355S	0	x	0.002000	=				
BEAM1224	0	x	0.017000	=				
CP355	0	x	0.000300	=				
SD355	18	x	0.000300	= 0.005400				
SD355T	0	x	0.000300	=				
AD355	0	x	0.000300	=				
H355	1	x	0.000300	= 0.000300				
H355R	0	x	0.000300	=				
H355HT	0	x	0.000300	=				
D350P	0	x	0.000300	=				
D350RP	0	x	0.000300	=				
D350PL	0	x	0.000300	=				
D350RPL	0	x	0.000300	=				
D355PL	0	x	0.000300	=				
MMF-300	0	x	0.000400	=				
MMF-300-10	0	x	0.003500	=				
MDF-300	0	x	0.000750	=				
MMF-301	0	x	0.000375	=				
MMF-302	0	x	0.000270	=				
MMF-302-6	0	x	0.002000	=				
BG-12LX	0	x	0.000230	=				
CMF-300	0	x	0.000390	=				
CMF-300-6	0	x	0.002250	=				
CRF-300	0	x	0.000270	=				
CRF-300-6	0	x	0.001450	=				
I300	0	x	0.000400	=				
B501BH-2	0	x	0.001000	=				
B501BHT-2	0	x	0.001000	=				
B224RB	0	x	0.000500	=				
B224BI	0	x	0.000450	=				

	Maximum alarm draw for all Addressable devices ----->								0.400000		
EOLR-1	2	x	0.020000	=	0.040000	2	x	0.020000	=	0.040000	
Miscellaneous Device 1	0	x	0.000000	=		0	x	0.000000	=		
Miscellaneous Device 2	0	x	0.000000	=		0	x	0.000000	=		
Miscellaneous Device 3	0	x	0.000000	=		0	x	0.000000	=		
Miscellaneous Device 4	0	x	0.000000	=		0	x	0.000000	=		
Miscellaneous Device 5	0	x	0.000000	=		0	x	0.000000	=		
NAC 1						0	x	0.000000	=		
NAC 2						0	x	0.000000	=		
NAC 3						0	x	0.000000	=		
NAC 4						0	x	0.000000	=		
Current Draw from TB3			0.000000	=				0.000000	=		
Total Standby Load					0.182700	Total Alarm Load					0.800000

MS-9200UDLS Rev.2 Battery Calculation

Note 1: You are **fully responsible** for verifying these calculations.

Note 2: Use the dropdowns in the **yellow** cells to enter values.

Calculation in Total Sheet

		Required Standby Time in Hours		
		24 Hours		
Standby Load Current	0.18270 Amps	x	24	= 4.385 AH
		Required Alarm Time in Minutes		
		5 Minutes		
Alarm Load Current (Amps)	0.80000 Amps	x	0.084	= 0.067 AH
Total Current Load				4.452 AH
Multiply by the Derating Factor			1.2	= x 1.20
Total Ampere Hours Required				5.34 AH

Recommended Batteries:	BAT-1270 - 7AH Batteries
-------------------------------	---------------------------------

Battery Check

The batteries can be charged by the MS-9200UDLS Charger.

The batteries can be housed in the MS-9200UDLS Cabinet.

Current Draw Check

NAC#1 current is within the limitations of the circuit.

NAC#2 current is within the limitations of the circuit.

NAC#3 current is within the limitations of the circuit.

NAC#4 current is within the limitations of the circuit.

MS 9200UDLS Control Panel:

The output current is within the panel's limitations.

Series NS Horn Strobes and Series NH Horns



Series NS

Series NH

Description:

The Series NS Horn Strobe Appliances are designed for indoor, wall and ceiling mount applications.

The Series NH Horn and the horn portion of the Series NS include a selectable continuous horn tone or temporal pattern (Code 3) with selectable dBA settings of 90 or 95 dBA.

Strobe options include 1575cd or the Wheelock patented Multi-Candela strobe with field selectable candela settings of 15/30/75/110cd for wall mount and 15/30/75/95cd and 115/177cd for ceiling mount.

These versatile Horn Strobe Appliances can be synchronized using the Wheelock SM, DSM Sync Modules, Wheelock Power Supplies or other manufacturers panels incorporating the Wheelock Patented Sync Protocol. Additionally, the audible may be silenced while maintaining strobe activation.

All models of the Series NS and NH are designed for maximum performance, reliability and cost-effectiveness while meeting or exceeding the latest requirements of NFPA 72/ANSI 117 1/UFC and UL Standards 1971 and 464 as well as meeting ADA requirements concerning photosensitive epilepsy.

The Wheelock patented 2-Wire Series NS Horn Strobes and Series NH Horns offer more features with lower current draw than competitors.

Features:

- Approvals include: UL Standard 1971, UL Standard 464, New York City (MEA), California State Fire Marshal (CSFM), Factory Mutual (FM) and Chicago (BFP). See approvals by model number in Specifications and Ordering Information
- ADA/NFPA/UFC/ANSI compliant
- Complies with OSHA 29, Part 1910.165
- Wall mount model Field Selectable Candela Setting 15/30/75/110cd (24 VDC Multi-Candela models) or 1575cd in 12 or 24 VDC
- Ceiling mount model Field Selectable Candela Setting 15/30/75/95cd and 115/177cd (24 VDC Multi-Candela models)
- Selectable Continuous Horn or Temporal (Code 3)
- 2 Selectable dBA settings of 90 and 95 dBA in both tones
- Patented Universal Mounting Plate
- 12 and 24 VDC models with UL "Regulated Voltage" using filtered DC or unfiltered VRMS input voltage
- Wall and Ceiling Mount
- Ceiling models with same look as Wheelock round ceiling strobes and speakers
- NH horn is selectable 12 or 24 VDC in 1 appliance
- Synchronize using Wheelock Sync Modules or panels with built-in Wheelock Patented Sync Protocol
- Fast installation with IN/OUT screw terminals using #12 to #18 AWG wires



E5946
S5391



151-92-E



7125-0785 142



NOTE: All CAUTIONS and WARNINGS are identified by the symbol **▲**. All warnings are printed in bold capital letters.

▲ WARNING: PLEASE READ THESE SPECIFICATIONS AND ASSOCIATED INSTALLATION INSTRUCTIONS CAREFULLY BEFORE USING, SPECIFYING OR APPLYING THIS PRODUCT. VISIT WWW.COOPERWHEELLOCK.COM OR CONTACT COOPER WHEELLOCK FOR THE CURRENT INSTALLATION INSTRUCTIONS. FAILURE TO COMPLY WITH ANY OF THESE INSTRUCTIONS, CAUTIONS OR WARNINGS COULD RESULT IN IMPROPER APPLICATION, INSTALLATION AND/OR OPERATION OF THESE PRODUCTS IN AN EMERGENCY SITUATION, WHICH COULD RESULT IN PROPERTY DAMAGE, AND SERIOUS INJURY OR DEATH TO YOU AND/OR OTHERS.

General Notes:

- Strobes are designed to flash at 1 flash per second minimum over their "Regulated Voltage Range". Note that NFPA-72 specifies a flash rate of 1 to 2 flashes per second and ADA Guidelines specify a flash rate of 1 to 3 flashes per second.
- All candela ratings represent minimum effective Strobe intensity based on UL Standard 1971.
- Series NS Strobe products are listed under UL Standard 1971 for indoor use with a temperature range of 32°F to 120°F (0°C to 49°C) and maximum humidity of 93% (± 2%).
- Series NH horns are listed under UL Standard 464 for audible signal appliances (Indoor use only).
- "Regulated Voltage Range" is the newest terminology used by UL to identify the voltage range. Prior to this change UL used the terminology "Listed Voltage Range".

Model	Input Voltage VDC	Regulated Voltage Range VDC/FWR	Strobe Candela (CD)
NS-24MCW	24	16.0 - 33.0	15/30/75/110
NS-241575W	24	16.0 - 33.0	15 (75 on Axis)
NS-121575W	12	8.0 - 17.5	15 (75 on Axis)
NS-24MCC	24	16.0 - 33.0	15/30/75/95
NS-24MCCH	24	16.0 - 33.0	115/177

Description	Volume	Reverberant dBA @ 10ft per UL 464		Anechoic dBA @ 10 ft	
		12 VDC	24 VDC	12 VDC	24 VDC
Continuous Horn	High	83	87	89	95
	Low	76	81	84	90
Code 3 Horn	High	79	82	89	95
	Low	72	76	84	90

Series NS/NH 24 VDC		Audible	Wall Mount Strobe Models					Ceiling Mount Strobe Models					
		NH-12/24	NS-241575W	NS-24MCW				NS-24MCC			NS-24MCCH		
		@24VDC	15/75cd	15cd	30cd	75cd	110cd	15cd	30cd	75cd	95cd	115cd	177cd
High (95) dBA	24VDC	0.044	0.104	0.074	0.107	0.184	0.244	0.082	0.124	0.209	0.275	0.350	0.477
Low (90) dBA	24VDC	0.018	0.096	0.066	0.101	0.177	0.232	0.071	0.114	0.201	0.261	0.306	0.429
Series NS/NH 12VDC		Audible	Wall Mount	* RMS current ratings are per UL average RMS method. UL max current rating is the maximum RMS current within the listed voltage range (16-33v for 24v units). For strobes the UL max current is usually at the minimum listed voltage (16v for 24v units). For audibles the max current is usually at the maximum listed voltage (33v for 24v units). For unfiltered FWR ratings, see installation instructions.									
		NH-12/24	Aud/Strobe										
		@12V	NS-121575W										
High (89) dBA	12 VDC	0.021	0.220										
Low (84) dBA	12VDC	0.012	0.210										

Wiring Diagrams*

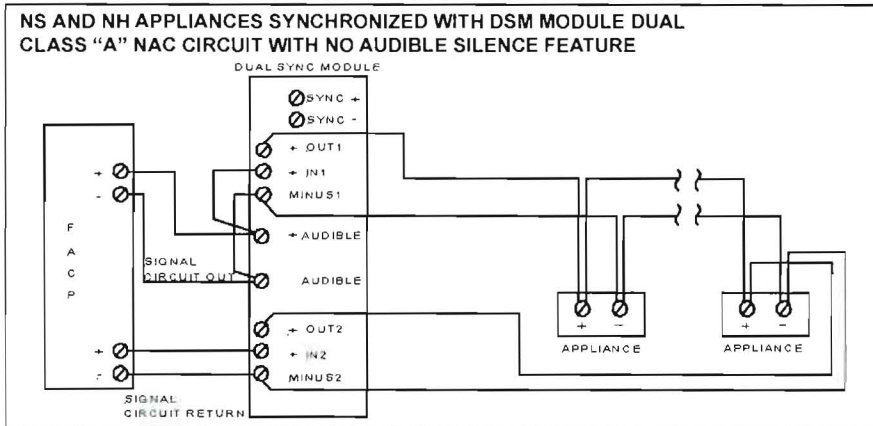
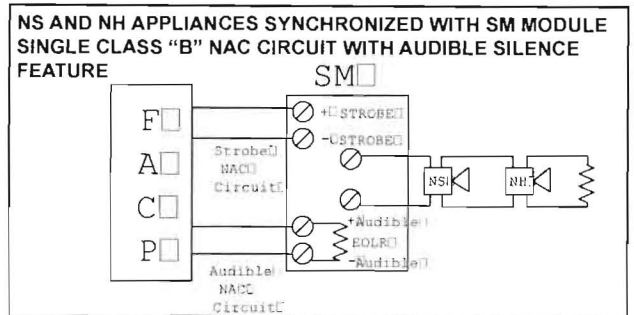
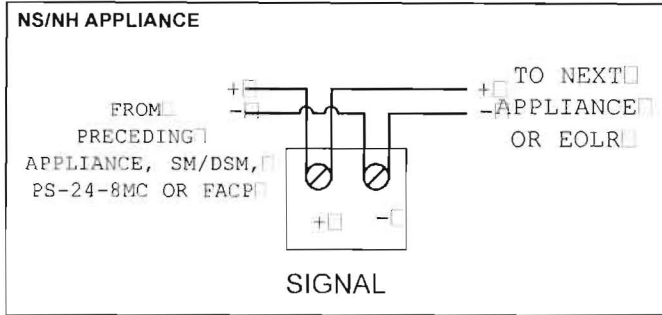

NOTE: NS/NH must be set on Code 3 horn tone to achieve synchronized temporal (Code 3) tone. Refer to installation instruction (P83983, P83600 respectively).

* For detail using SM or DSM Sync Module refer to Data Sheet S3000 or Installation Instructions P83123 for SM and P83177 for DSM. For wiring information on the power supplies refer to Installation Instructions P84662 for PS-24-8MC.

SPECIFICATION & ORDERING INFORMATION

Model Number	Order Code	Strobe Candela	Sync w/ SM, DSM or PS-24-8MC	24 VDC	12 VDC	Mounting Options#	Agency Approvals				
							UL	MEA	CSFM	FM	BFP
NS-24MCW-FR	9404	15/30/75/110	X	X	-	B,D,E,F,G,H,J,N,O,R,X	X	X	X	X	X
NS-24MCW-FW	9405	15/30/75/110	X	X	-	B,D,E,F,G,H,J,N,O,R,X	X	X	X	X	X
NS-241575W-FR	7806	15 (75 on Axis)	X	X	-	B,D,E,F,G,H,J,N,O,R,X	X	X	X	X	X
NS-241575W-FW	7811	15 (75 on Axis)	X	X	-	B,D,E,F,G,H,J,N,O,R,X	X	X	X	X	X
NS-121575W-FR	7816	15 (75 on Axis)	X	-	X	B,D,E,F,G,H,J,N,O,R,X	X	X	X	X	X
NS-121575W-FW	7818	15 (75 on Axis)	X	-	X	B,D,E,F,G,H,J,N,O,R,X	X	X	X	X	X
NH-12/24-R	7449	-	X	X	X	B,D,E,F,G,H,J,N,O,R,X	X	X	X	X	X
NH-12/24-W	7500	-	X	X	X	B,D,E,F,G,H,J,N,O,R,X	X	X	X	X	X
NS-24MCC-FR	3754	15/30/75/95	X	X	-	E	X	*	X	X	*
NS-24MCC-FW	3753	15/30/75/95	X	X	-	E	X	*	X	X	*
NS-24MCCH-FR	3756	115/177	X	X	-	E	X	*	X	X	*
NS-24MCCH-FW	3755	115/177	X	X	-	E	X	*	X	X	*
NH-12/24R-R	3752	-	X	X	X	D & E	X	*	X	X	*
NH-12/24R-W	3751	-	X	X	X	D & E	X	*	X	X	*

*Pending

Note: Models are available in Red or White. Contact Customer Service for Order Code and Delivery.

#Refer to Data Sheet S7000 for Mounting Options

NOTE: Due to continuous development of our products, specifications and offerings are subject to change without notice in accordance with Wheelock Inc. standard terms and conditions.

ARCHITECTS AND ENGINEERS SPECIFICATIONS

The audible/visual notification appliances shall be Wheelock Series NS Horn Strobe appliances and Series NH Horn appliances or approved equals. The Series NS appliances shall meet and be listed for UL Standard 1971 (Emergency Devices for the Hearing-Impaired for Indoor Fire Protection Service). The Series NH Horn shall be UL Listed under Standard 464 (Fire Protective Signaling). The horn strobe shall be listed for indoor use and shall meet the requirements of FCC Part 15 Class B. All inputs shall be compatible with standard reverse polarity supervision of circuit wiring by the Fire Alarm Control Panel (FACP).

The audible portion of the appliance shall have a minimum of two (2) field selectable settings for dBA levels (90 and 95 dBA) and shall have a choice of continuous or temporal (Code 3) audible outputs.

The strobe portion of the appliance shall produce a flash rate of one (1) flash per second over the Regulated Voltage Range and shall incorporate a Xenon flashtube enclosed in a rugged Lexan lens. The Series NS shall be of low current design. Where wall mount, Multi-Candela appliances are specified, the strobe intensity shall have field selectable settings and shall be rated per UL Standard 1971 for 15/30/75/110 candela. Where ceiling mount, Multi-Candela appliances are specified, the strobe intensity shall have field selectable settings and shall be rated per UL Standard 1971 for 15/30/75/95 candela or 115/177 candela. The selector switch for selecting the candela setting shall be tamper resistant. The 1575 candela strobe shall be specified when 15 candela UL Standard 1971 Listing with 75 candela on-axis is required (e.g. ADA compliance).

When synchronization is required, the appliance shall be compatible with the Wheelock SM, DSM Sync Modules, Wheelock Power Supplies or other manufacturers panels with built-in Wheelock Patented Sync Protocol. The strobes shall not drift out of synchronization at any time during operation. If the sync module or Power Supply fails to operate, (i.e., contacts remain closed), the strobes shall revert to a non-synchronized flash-rate. The appliance shall also be designed so that the audible signal may be silenced while maintaining strobe activation.

The Series NS Horn Strobes and NH horn shall incorporate a Patented Universal Mounting Plate that shall allow mounting to a single-gang, double-gang, 4-inch square, 100mm European type backboxes, or the SHBB Surface Backbox. If required, an NATP (Notification Appliance Trimplate) shall be provided.

All notification appliances shall be backward compatible.



WE ENCOURAGE AND SUPPORT NICET CERTIFICATION
3 YEAR WARRANTY
Made in USA

S2100 NS/NH 2/08

NJ Location
273 Branchport Ave.
Long Branch, NJ 07740
P: 800-631-2148
F: 732-222-8707
www.coopernotification.com

FL Location
7565 Commerce Ct.
Sarasota, FL 34243
P: 941-487-2300
F: 941-487-2389

VA Location
2009 North 14th St., Ste. 510
Arlington, VA 22201
P: 877-459-7726
F: 703-294-6560

Cooper Notification is Wheelock*    

COOPER Notification

SD355(A), SD355T(A)

Addressable Photoelectric Smoke Detectors

 **Fire-Lite Alarms**
by Honeywell

Addressable Devices

GENERAL

The **SD355(A)** and **SD355T(A)** addressable, low-profile plug-in photoelectric detectors use a state-of-the-art photoelectric sensing chamber with communications to provide open area protection and are used exclusively with Fire-Lite's Addressable Fire Alarm Control Panels (FACPs). The SD355T(A) adds thermal sensors that will alarm at a fixed temperature of 135°F (57°C). Since these detectors are addressable, they will help emergency personnel quickly locate a fire during its early stages, potentially saving precious rescue time while also reducing property damage. Two LEDs on each sensor light to provide a local, visible sensor indication. Remote LED annunciator capability is available as an optional accessory (P/N RA400Z).

FEATURES

SLC loop:

- Two-wire loop connection.
- Unit uses base for wiring.

Addressing:

- Addressable by device.
- Direct Decade entry of address: 01 – 99 with MS-9200 series, and 01 – 159 with MS-9600 series.

Architecture:

- Unique single-source, dual-chamber design to respond quickly and dependably to a broad range of fires.
- Sleek, low-profile design.
- Integral communications and built-in type identification.
- Built-in tamper-resistant feature.
- Removable cover and insect-resistant screen for simple field cleaning.

Operation:

- Withstands air velocities up to 4,000 feet-per-minute (20 m/sec.) without triggering a false alarm.
- Factory preset at 1.5% nominal sensitivity for panel alarm threshold level.
- Visible LED "blinks" when the unit is addressed (communicating with the fire panel) and latches on in alarm.

Mechanicals:

- Sealed against back pressure.
- Direct surface mounting or electrical box mounting.
- Mounts to: single-gang box, 3.5" (8.89 cm) or 4.0" (10.16 cm) octagonal box, or 4.0" (10.16 cm) square electrical box (using a plaster ring — included).

Other system features:

- Fully coated circuit boards and superior RF/transient protection.
- 94-V0 plastic flammability rating.
- Low standby current.

Options:

- Remote LED output connection (P/N RA400Z).



SD355 with B350LP base



SD355T with B350LP base

APPLICATIONS

Use photoelectric detectors in life-safety applications to provide a broad range of fire-sensing capability, especially where smoldering fires are anticipated. Ionization detectors are often better than photoelectric detectors at sensing fast, flaming fires.

CONSTRUCTION

These detectors are constructed of off-white LEXAN®. SD355(T) plug-in, low-profile smoke detectors are designed to commercial standards and offer an attractive appearance.

INSTALLATION

SD355(T) plug-in detectors use a detachable mounting base to simplify installation, service and maintenance. Mount base on box which is at least 1.5 inches (3.81 cm) deep. Suitable boxes include:

- 4.0" (10.16 cm) square box with plaster ring.
- 4.0" (10.16 cm) octagonal box.
- 3.5" (8.89 cm) octagonal box.
- Single-gang box.

NOTE: Because of the inherent supervision provided by the SLC loop, **end-of-line resistors** are not required. Wiring "T-taps" or branches are permitted for Style 4 (Class B) wiring.

OPERATION

Each SD355(T) uses one of 99 possible addresses on the MS-9200 series and up to 318 (159 on each loop) on the MS-9600 Signaling Line Circuit (SLC). It responds to regular polls from the system and reports its type and status.

The SD355(T) addressable photoelectric sensor's unique unipolar chamber responds quickly and uniformly to a broad range of smoke conditions and can withstand wind gusts up to 4,000 feet-per-minute (20 m/sec.) without sending an alarm level signal. Because of its unipolar chamber, the SD355(T) is approximately two times more responsive than most photoelectric sensors. This makes it a more stable detector.

DETECTOR SENSITIVITY TEST

Each detector can have its sensitivity tested (required per NFPA 72, Chapter 10 on *Inspection, Testing and Maintenance*) when installed/connected to a MS-9200 series or MS-9600 series addressable fire alarm control panel. The results of the sensitivity test can be printed off the MS-9200 series or MS-9600 series for record keeping.

SPECIFICATIONS

Voltage range: 15 – 32 VDC (peak).

Standby current: 300 μ A @ 24 VDC.

LED current: 6.5 mA @ 24 VDC (latched "ON").

Air velocity: 4,000 ft./min. (20 m/sec.) maximum.

Diameter: 6.1" (15.5 cm) installed in B350LP base.

Height: 2.1" (5.33 cm) installed in B350LP base.

Weight: 3.6 oz. (102 g).

Operating temperature range: for **SD355(A):** 0°C to 49°C (32°F to 120°F); for **SD355T(A):** 0°C to 38°C (32°F to 100°F).

Temperature: 0°C – 49°C (32°F – 120°F).

Relative humidity: 10% – 93%, non-condensing.

LISTINGS

Listings and approvals below apply to the SD355(A) and SD355T(A) detectors. In some cases, certain modules may not be listed by certain approval agencies, or listing may be in process. Consult factory for latest listing status.

- UL Listed, file S1059.
- ULC Listed, file S6963.
- CSFM approved: file 7272-0075:194.
- MEA approved: file 243-02-E.
- FM approved.

PRODUCT LINE INFORMATION

NOTE: "A" suffix indicates ULC-Listed model.

SD355: Addressable photoelectric detector; B350LP base included.

SD355A: Same as SD355 with ULC Listing (B350LPA base included).

SD355T: Same as SD355 but with **thermal** element; B350LP base included.

SD355TA: Same as SD355T with ULC Listing (B350LPA base included).

B350LP(A): Plug-in detector base. **Dimensions:** 6.1" (15.5 cm). **Mounting:** 4.0" (10.16 cm) square box with or without plaster ring, 4.0" (10.16 cm) octagonal box, 3.5" (8.89 cm) octagonal box, or single-gang box. All mounting boxes have a minimum depth of 1.5" (3.81 cm).

B224RB(A): Plug-in System Sensor **relay** detector base. **Diameter:** 6.2" (15.75 cm). **Mounting:** 4.0" (10.16 cm) square box with or without plaster ring, 4.0" (10.16 cm) octagonal box, or 3.5" (8.89 cm) octagonal box. All mounting boxes have a minimum depth of 1.5" (3.81 cm).

B224BI(A): Plug-in System Sensor **isolator** detector base. Maximum 25 devices between isolator bases (*see DF-52389*). **Diameter:** 6.2" (15.75 cm). **Mounting:** 4.0" (10.16 cm) square box with or without plaster ring, 4.0" (10.16 cm) octagonal box, or 3.5" (8.89 cm) octagonal box. All mounting boxes have a minimum depth of 1.5" (3.81 cm).

B501BH-2(A): Plug-in System Sensor **sounder** detector base. **Diameter:** 6.0" (15.24 cm). **Mounting:** 4.0" (10.16 cm) square box with or without plaster ring. Mounting box has a minimum depth of 1.5" (3.81 cm).

B501BHT-2(A): Plug-in System Sensor **temporal tone** sounder detector base.

ACCESSORIES:

RA400Z(A): Remote LED annunciator. 3 – 32 VDC. Mounts to a U.S. single-gang electrical box. *For use with B501(A) and B350LP(A) bases only.*

SMK400E: Surface mounting kit provides for entry of surface wiring conduit. *For use with B501(A) base only.*

RMK400: Recessed mounting kit. *For use with B501(A) base only.*

M02-04-00: Test magnet.

M02-09-00: Test magnet with telescoping handle.

XR2B: Detector removal tool. Allows installation and/or removal of detector heads from bases in high ceiling applications.

XP-4: Extension pole for XR2B. Comes in three 5-foot (1.524 m) sections.

T55-127-010: Detector removal tool without pole.

BCK-200B: Black detector covers, box of 10.

WCK-200B: White detector covers, box of 10.

FlashScan® registered trademark of Honeywell International Inc. Bayblend® is a registered trademark of Bayer Corporation.

©2009 by Honeywell International Inc. All rights reserved. Unauthorized use of this document is strictly prohibited.



This document is not intended to be used for installation purposes.
We try to keep our product information up-to-date and accurate.
We cannot cover all specific applications or anticipate all requirements.
All specifications are subject to change without notice.

For more information, contact Fire•Lite Alarms. Phone: (800) 627-3473. FAX: (877) 699-4105.
www.firelite.com

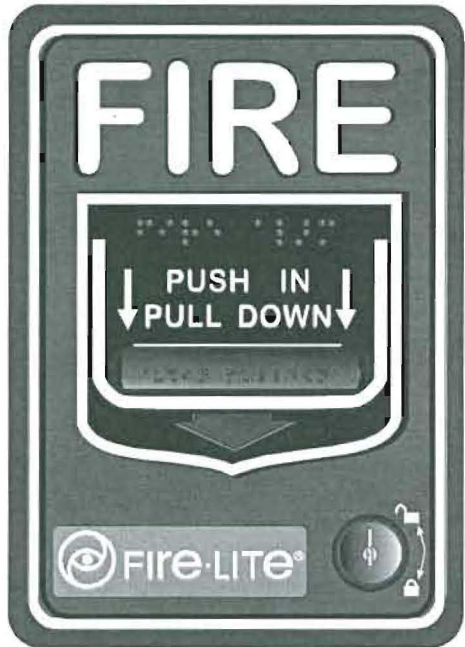

BG-12LX Addressable Pull Station

Document 51094 Revision A2 ECN 00-032 01/14/2000

Description

The BG-12LX Addressable pull station is a non-coded, dual-action manual pull station with a key-lock reset feature. It provides Fire•Lite intelligent control panels with one addressable alarm initiating input. The addressable module is housed inside the pull station. The BG-12LX is compatible with all Fire•Lite intelligent panels. The BG-12LX meets the ADA requirement for a 5-lb. maximum pull force to activate the pull station. Operating instructions are molded into the pull station handle along with Braille text. Molded Terminal numbers are also present.

Installation

The BG-12LX Addressable pull station can be surface mounted to an SB-10 surface backbox or semi-flush mounted on a standard single-gang, double-gang or 4" (10.16 cm) square electrical box. The optional BG-TR trim ring can be used if the BG-12LX is to be semi-flush mounted.

Ratings

Normal Operating Voltage: 24 VDC.
Average Operating Current (LED Flash): 300 μ A.
Temperature Range: 32° F - 120° F (0° C - 49° C).
Relative Humidity Range: 10% - 93% non-condensing.

Setting the BG-12LX Address

The BG-12LX Addressable pull station is factory preset with address '00.' Set the address for the pull station by turning the rotary address switches on the addressable module mounted inside the pull station. Only one device per address is allowed. Multiple modules may not be set to the same address on the Signaling Line Circuit. Once the address is set, record it in the space provided on the product ID label located inside the pull station.

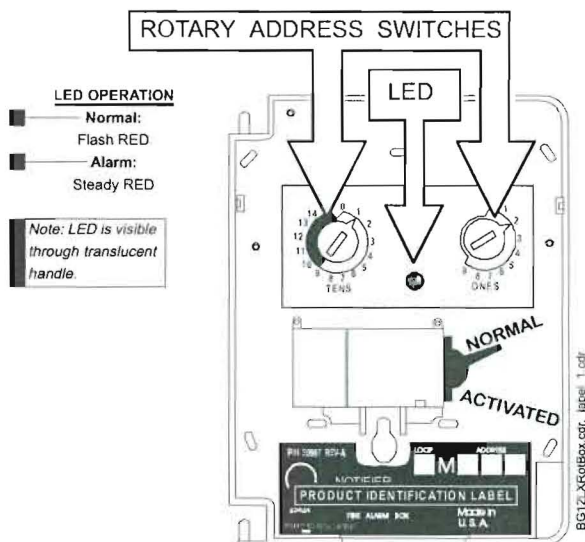

If, during mounting of the pull station, the door becomes detached, complete the following steps to reattach the door to the backplate. The door cannot be connected to the pull station if the unit is mounted to the backbox.

1. Position the door and backplate side by side in the full open position. (i.e. 180-degrees with respect to each other.)
2. With the backplate position fixed, move the door behind the backplate, as shown in the illustration, part A.
3. Align the hinge posts and holes by bringing the door up to meet the backplate, paying particular attention to the 'keying' that occurs when the door's post hole is aligned to the backplate's hinge post. Refer to the illustration, part B.
4. With the two pieces aligned and 'keyed' together, slide the holes down onto the posts. Refer to the illustration, part C.
5. Holding the backplate, close the door and backplate slightly to lock the door and backplate together.

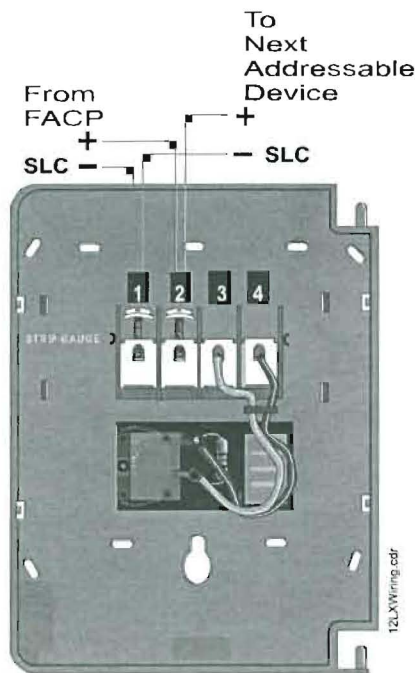

Wiring

- 1) If flush mounting, proceed to step 4.
- 2) Mount the backbox before wiring it to the pull station.
- 3) Before surface mounting the pull station, pull all wiring through the backbox and optional trim ring.
- 4) Remove the appropriate amount of wire insulation. The pull station back plate is molded with a strip gauge to measure the amount of insulation to be removed.
- 5) Connect the wiring from the addressable fire alarm control panel's Signaling Line Circuit (SLC) to Terminals 1(-) and 2(+) on the BG-12LX addressable pull station. SLC polarity is critical for this connection.
- 6) Connect the wiring going to the next device on the SLC to Terminals 1 and 2, again being certain to observe polarity.
- 7) Open the pull station door; align the mounting holes of the pull station backplate to the backbox and screw into place. Tighten top and bottom screws.
- 8) Set the address as described in 'Setting the BG-12LX Address' and write the address in the space provided on the label.
- 9) Insure that the alarm switch is in the normal position. Close and lock the pull station door.

Operation

Push-in and pull-down the handle where indicated to activate the station. The BG-12LX manual fire alarm pull station includes one SPST (Single Pole, Single Throw) N/O (normally-open) switch and the addressable module located inside the station. Pushing-in and pulling-down the dual action handle causes the N/O alarm switch to close. The word 'ACTIVATED' is displayed on the top of the handle when the pull station handle is Pushed-in and pulled-down. The activated handle can not be reset without employing the key-lock reset. To reset the BG-12LX pull station: 1) Insert the key and turn counterclockwise, 2) Open the door until the handle moves back into the 'NORMAL' position, 3) Close the door and lock it. Closing the door automatically resets the BG-12LX to the 'NORMAL' position.



ACTIVATED
BG-12LX PULL
STATION

Note - Opening the pull station door will not activate or deactivate the alarm switch.

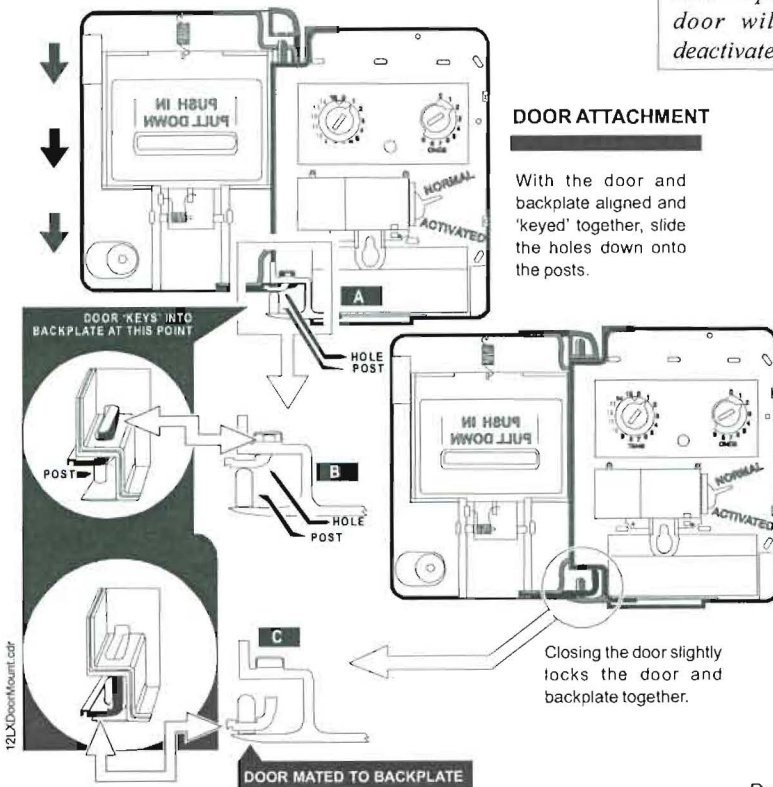

DOOR ATTACHMENT

With the door and backplate aligned and 'keyed' together, slide the holes down onto the posts.

CAUTION!

Install the Fire•Lite BG-12LX manual pull station in accordance with these instructions, applicable NFPA standards, national and local Fire and Electrical codes and the requirements of the AHJ (Authority Having Jurisdiction). Regular testing of the devices should be conducted in accordance with the appropriate NFPA standards. Failure to follow these directions may result in failure of the device to report an alarm condition. Fire•Lite is not responsible for devices that have been improperly installed, tested or maintained.

For ADA compliance, if the clear floor space only allows forward approach to an object, the maximum forward reach height allowed is 48 in. (1,220 mm). If the clear floor space allows parallel approach by a person in a wheelchair, the maximum side reach height allowed is 54 in. (1,370 mm).



CITY OF PORTLAND, MAINE

Department of Building Inspections

Original Receipt

Dec. 15 2009

Received from Joseph Corio

Location of Work 449 Franklin Ave

Cost of Construction \$ _____ Building Fee: _____

Permit Fee \$ _____ Site Fee: _____

Certificate of Occupancy Fee: _____

Total: 160.00

Building (IL) Plumbing (I5) _____ Electrical (I2) _____ Site Plan (U2) _____

Other File Cabinet

CBL: 111 A016

Check #: CC Total Collected \$ 160.00

**No work is to be started until permit issued.
Please keep original receipt for your records.**

Taken by: Jayle

WHITE - Applicant's Copy
YELLOW - Office Copy
PINK - Permit Copy



CITY OF PORTLAND, MAINE

Department of Building Inspections

Original Receipt

10.11.09

Received from _____

Location of Work _____

Cost of Construction \$ _____ Building Fee: _____

Permit Fee \$ _____ Site Fee: _____

Certificate of Occupancy Fee: _____

Total: _____

Building (I1) _____ Plumbing (I5) _____ Electrical (I2) _____ Site Plan (U2) _____

Other _____

CBL: _____





Check #: _____ Total Collected \$ _____

**No work is to be started until permit issued.
Please keep original receipt for your records.**

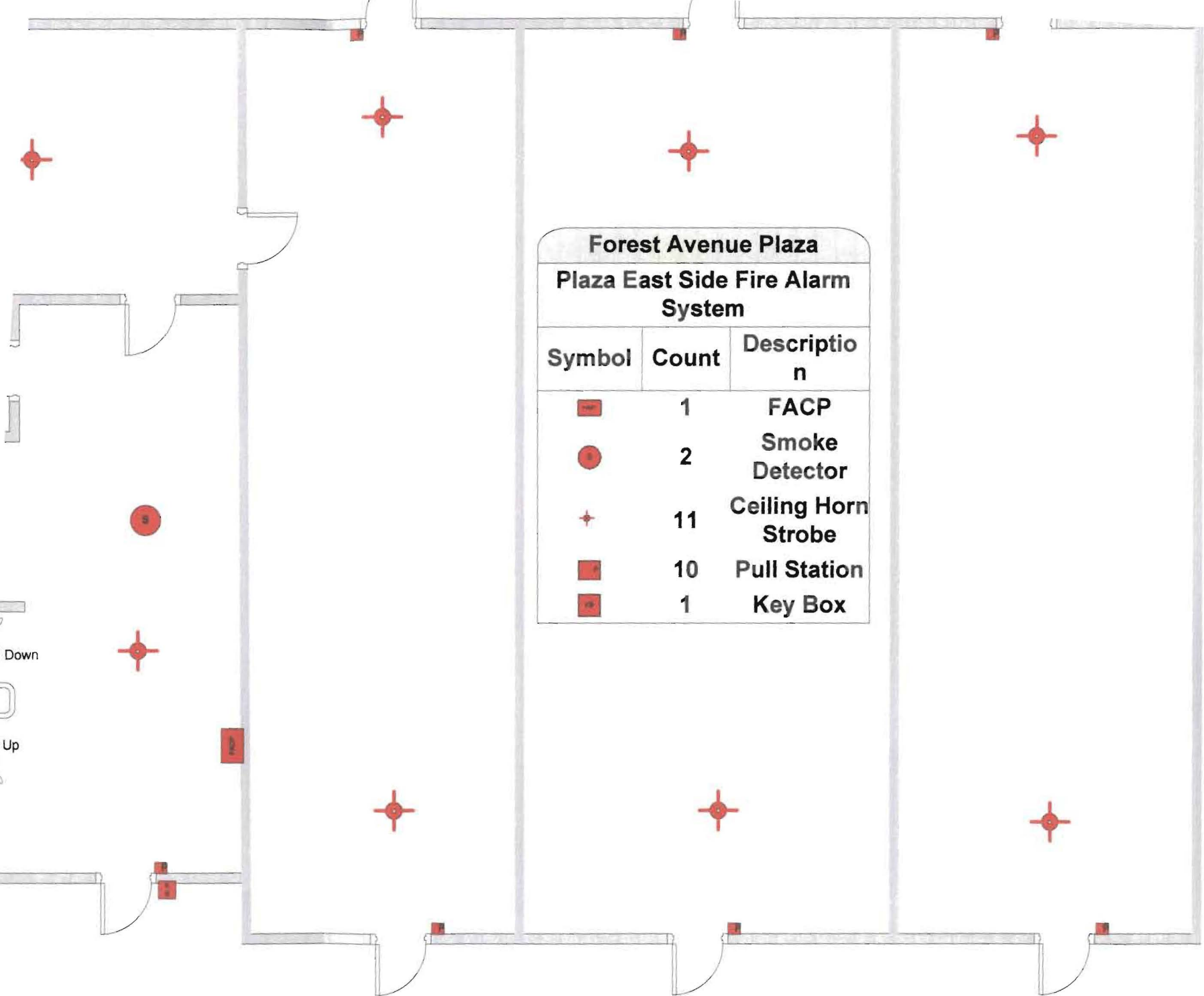







Taken by: _____

WHITE - Applicant's Copy
YELLOW - Office Copy
PINK - Permit Copy



Forest Avenue Plaza Plaza East Side Fire Alarm System		
Symbol	Count	Description
	1	FACP
	2	Smoke Detector
	11	Ceiling Horn Strobe
	10	Pull Station
	1	Key Box

Robin Russell, Certified Engineering Technician, NICET Cert. # 110826

Forest Avenue Plaza		
Plaza West Fire Alarm System		
Symbol	Count	Description
	1	Waterflow Switch
	1	Tamper
	6	Ceiling Horn Strobe
	6	Pull Station
	7	Horn Strobe
	7	Strobe
	10	Smoke Detector
	2	Heat Detector
	1	Key Box



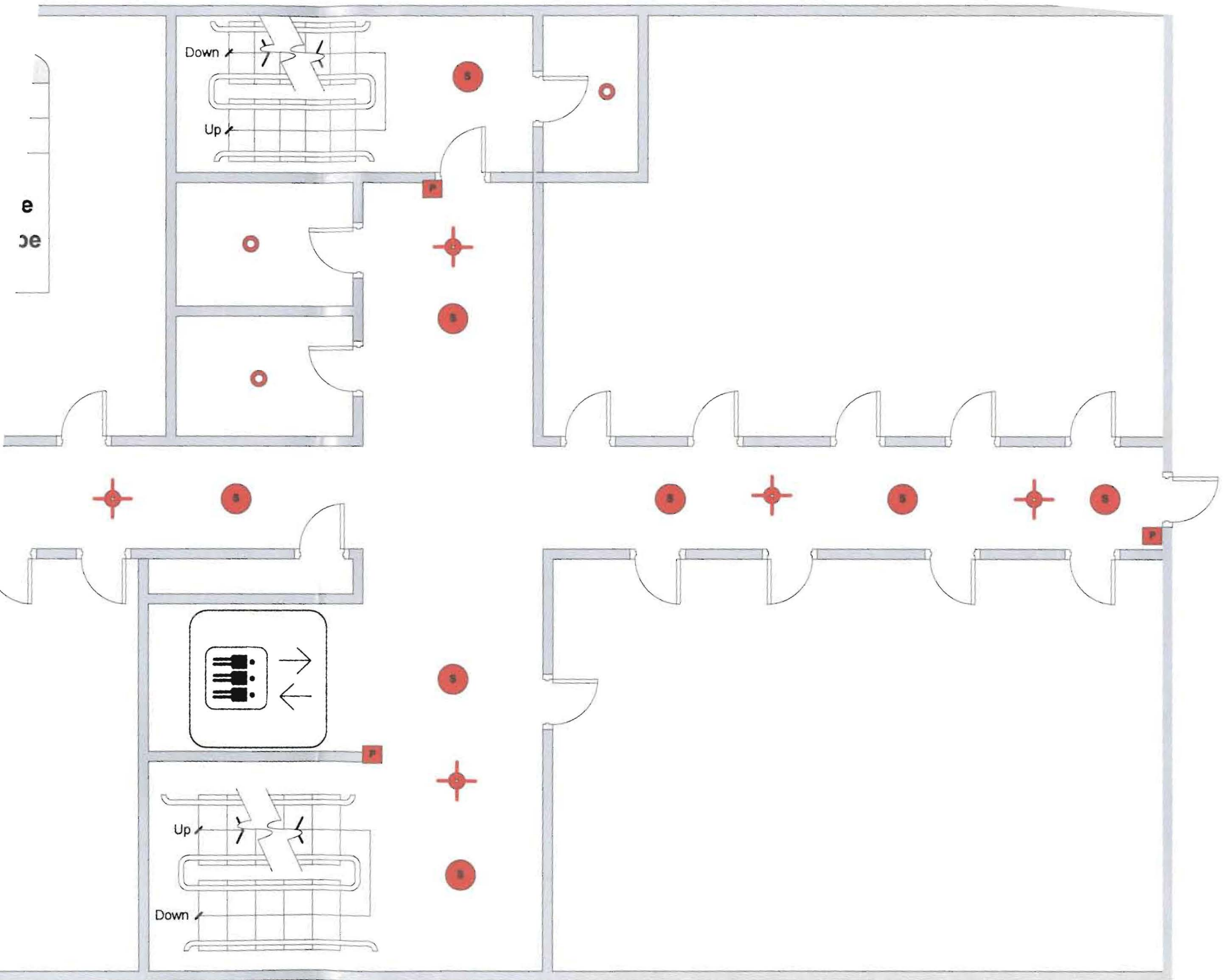

Robin Russell, Certified Engineering Technician, NICET Cert. # 110826

21103 (207) 347-5327

12/07/09