

SECTION F
SCALE: 1/2"=1'-0"
TRUCK RAMP DOCK & MISC. DETAILS
(LKG THRU SLAB @ EL. 22.0')

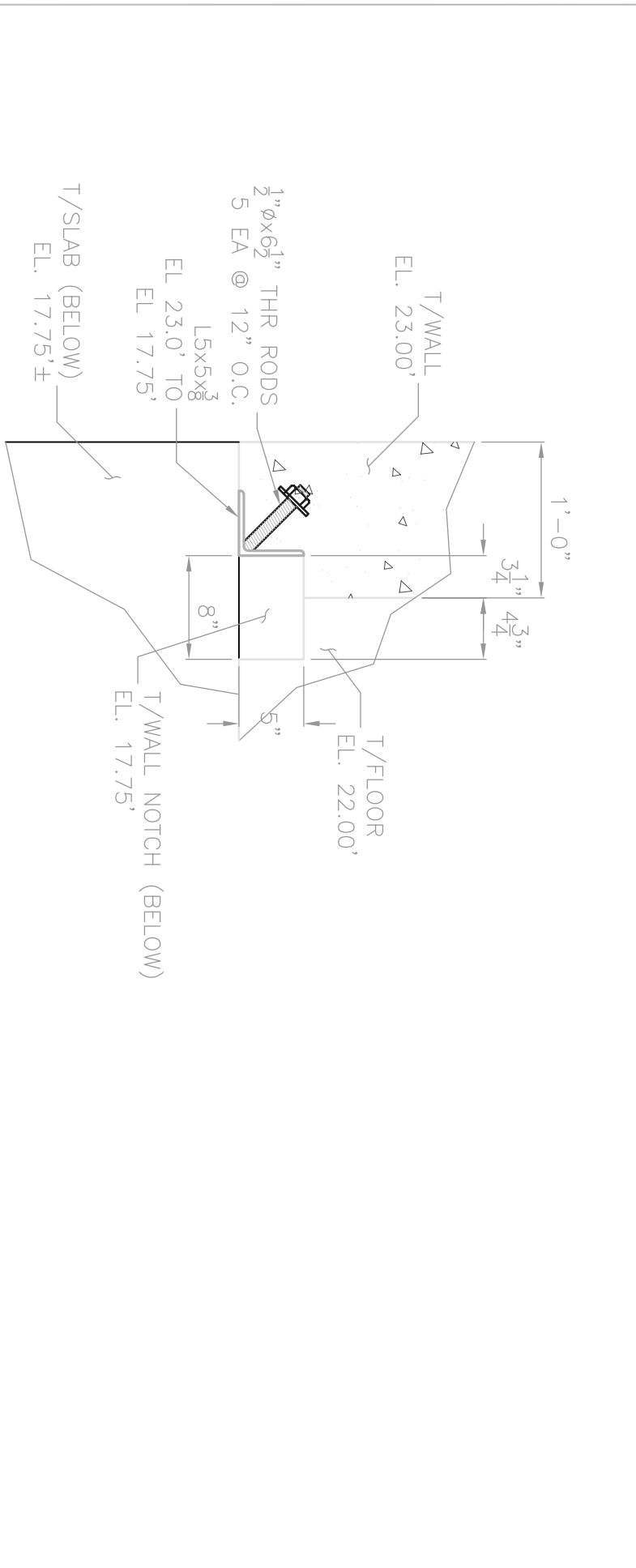

SECTION D
SCALE: 3/8"=1'-0"
TRUCK RAMP SLAB & FOUNDATION
(LKG THRU SLAB @ EL. 22.0')

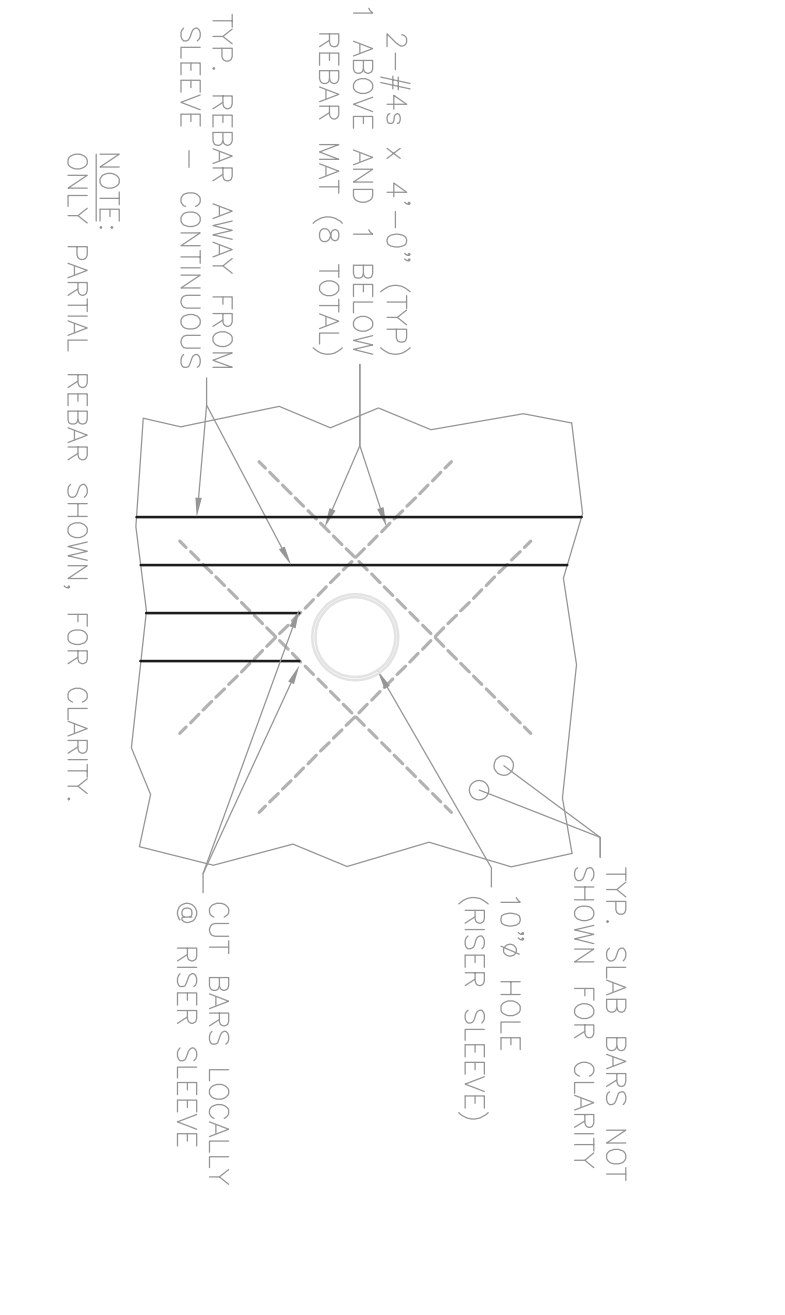

SECTION E
SCALE: 3/4"=1'-0"
TRUCK RAMP SLAB & FOUNDATION
(LKG THRU SLAB @ EL. 22.0')

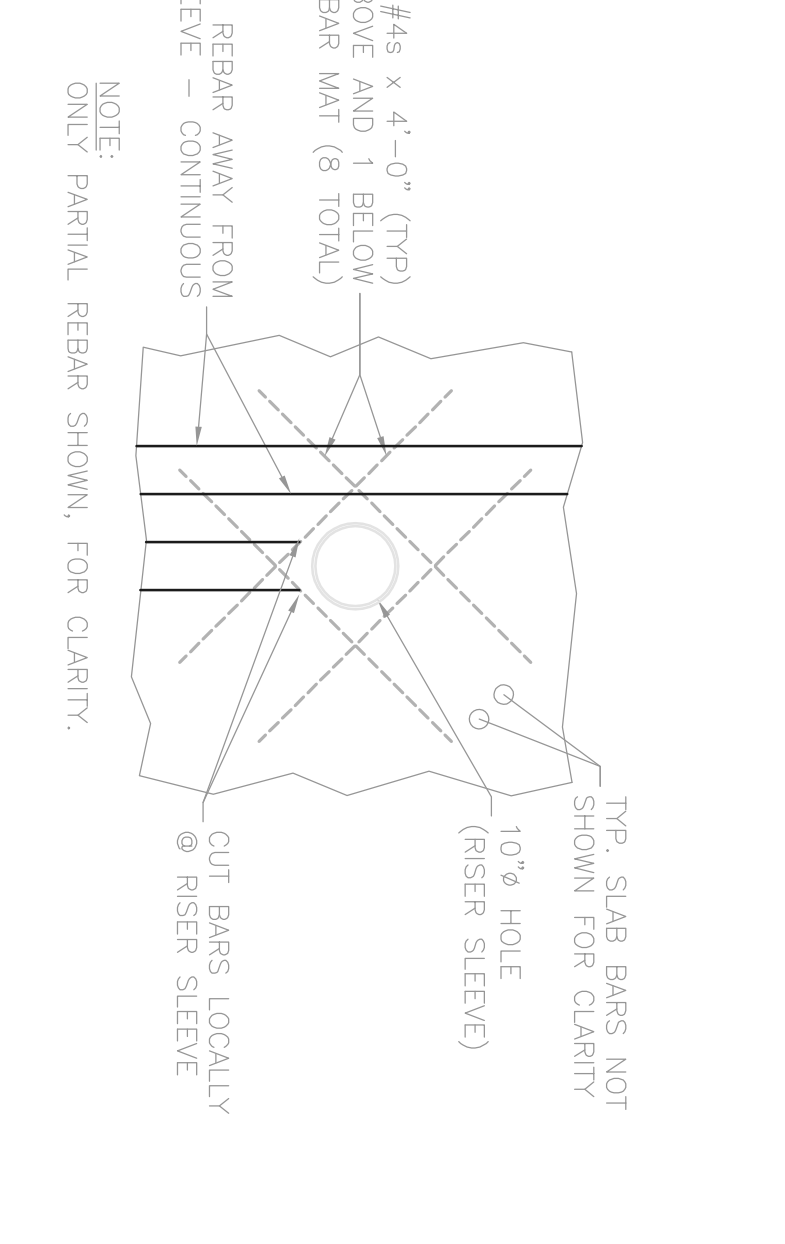

SECTION B
SCALE: 3/8"=1'-0"
TRUCK RAMP DOCK & MISC. DETAILS
(LKG THRU SLAB @ EL. 22.0')

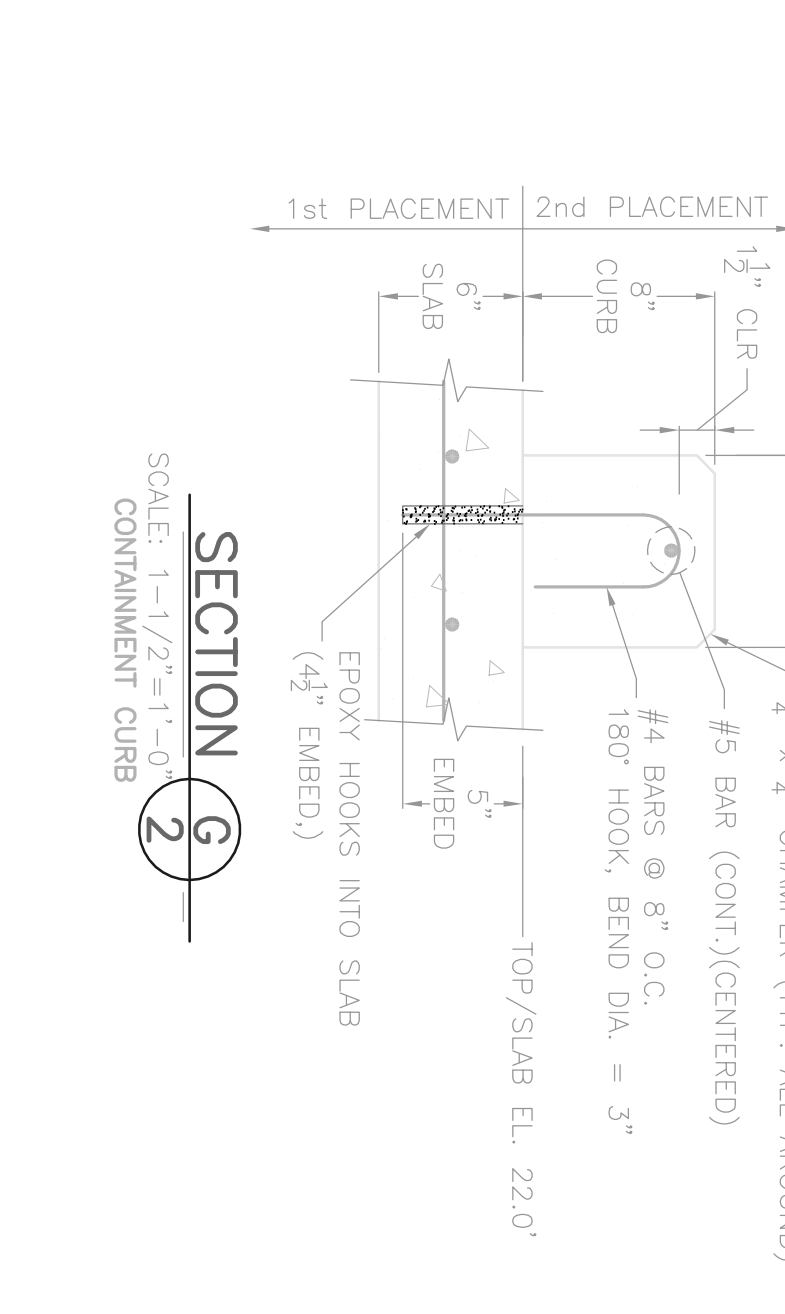

SECTION G
SCALE: 1-1/2"=1'-0"
CONTAINMENT CURB

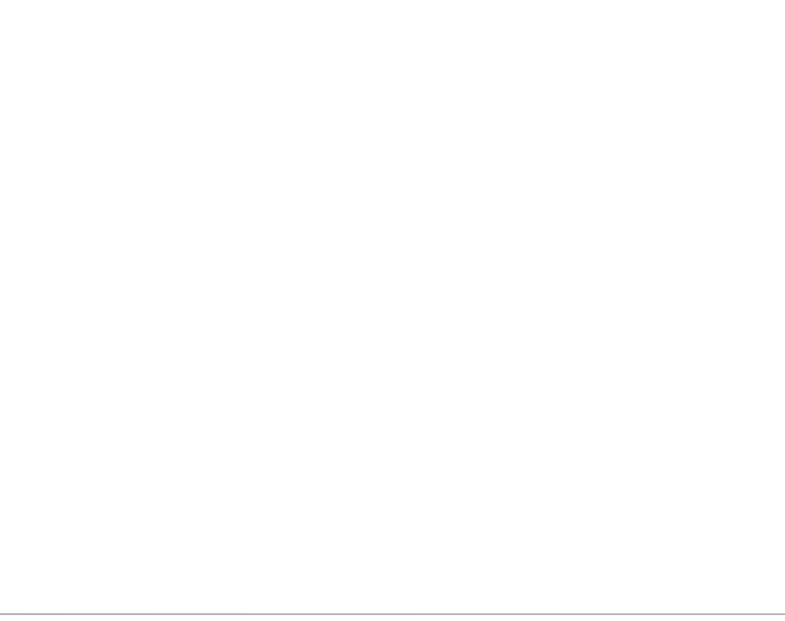

SECTION H
SCALE: 3/4"=1'-0"
CHANNEL @ TRUCK RAMP WALL FACE
(ANGLE @ CORNERS, SIM.)

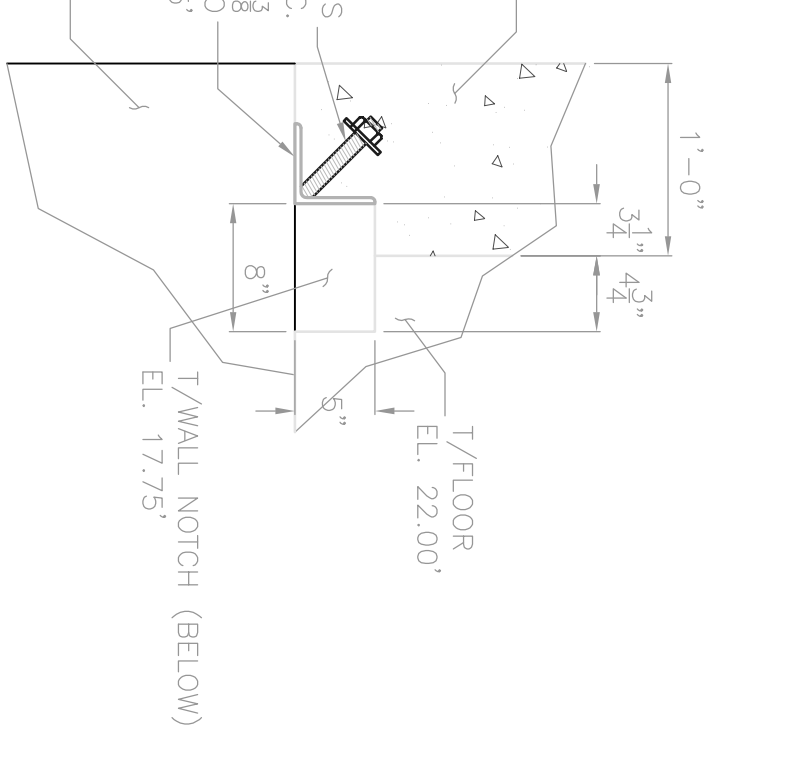

SECTION RN
SCALE: 1"=1'-0"
TRUCK RAMP DOOR NOTCH
(LKG DOWN)



SECTION FR
SCALE: 1/2"=1'-0"
FIRE RISER SLEEVE
(SPECIFIC LOCATION & RISER DETAILS BY OTHERS)

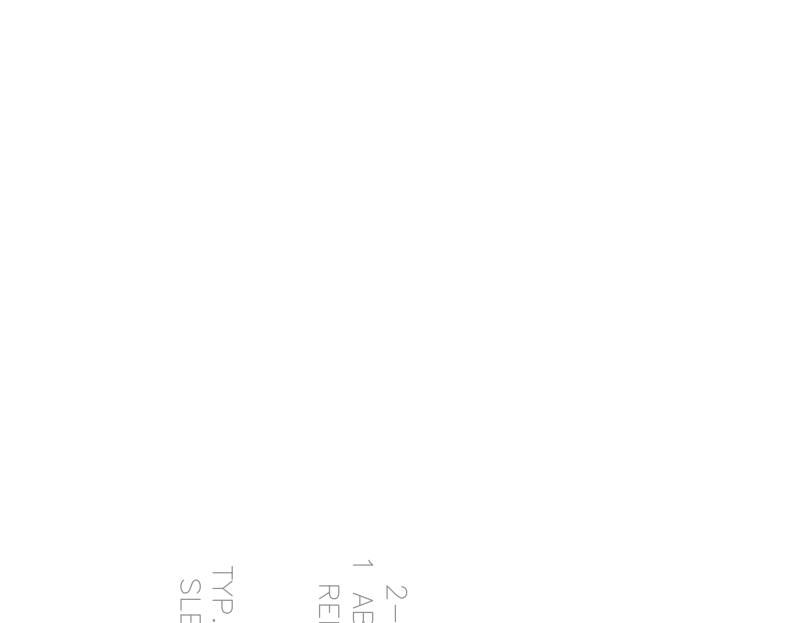

DETAIL 9
SCALE: 1-1/2"=1'-0"
CHANNEL @ TRUCK RAMP WALL FACE

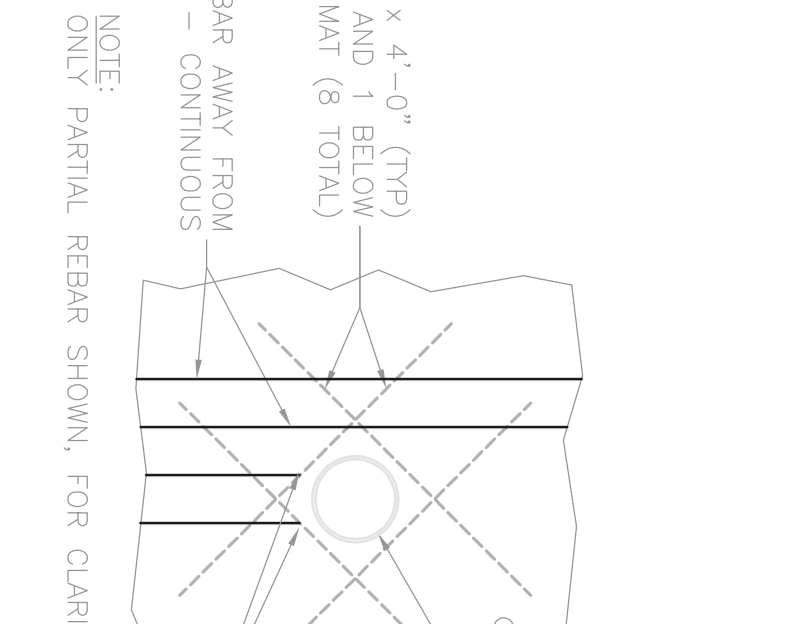

DETAIL 10
SCALE: 1-1/2"=1'-0"
CHANNEL @ TRUCK RAMP WALL
ANGLE @ OUTSIDE CORNER

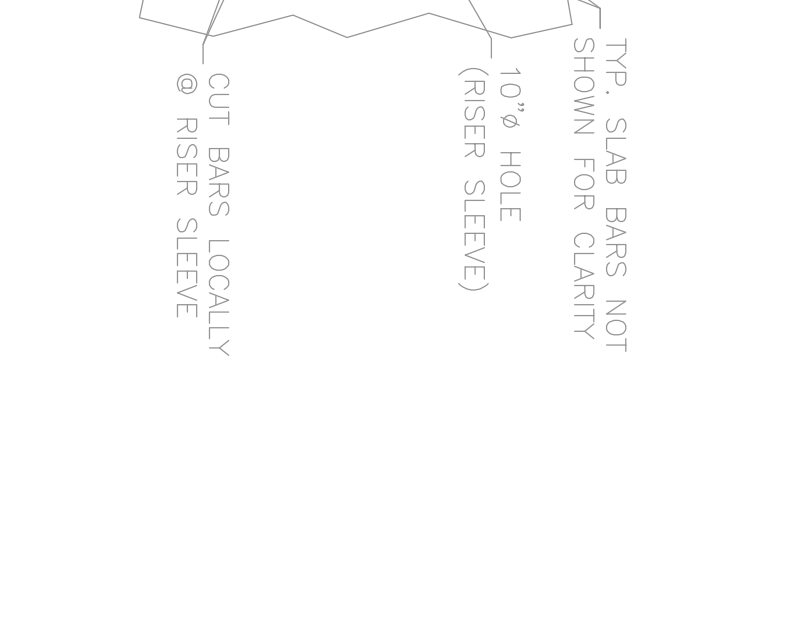

DETAIL 11
SCALE: 1-1/2"=1'-0"
CHANNEL @ TRUCK RAMP WALL
ANGLE @ INSIDE CORNER

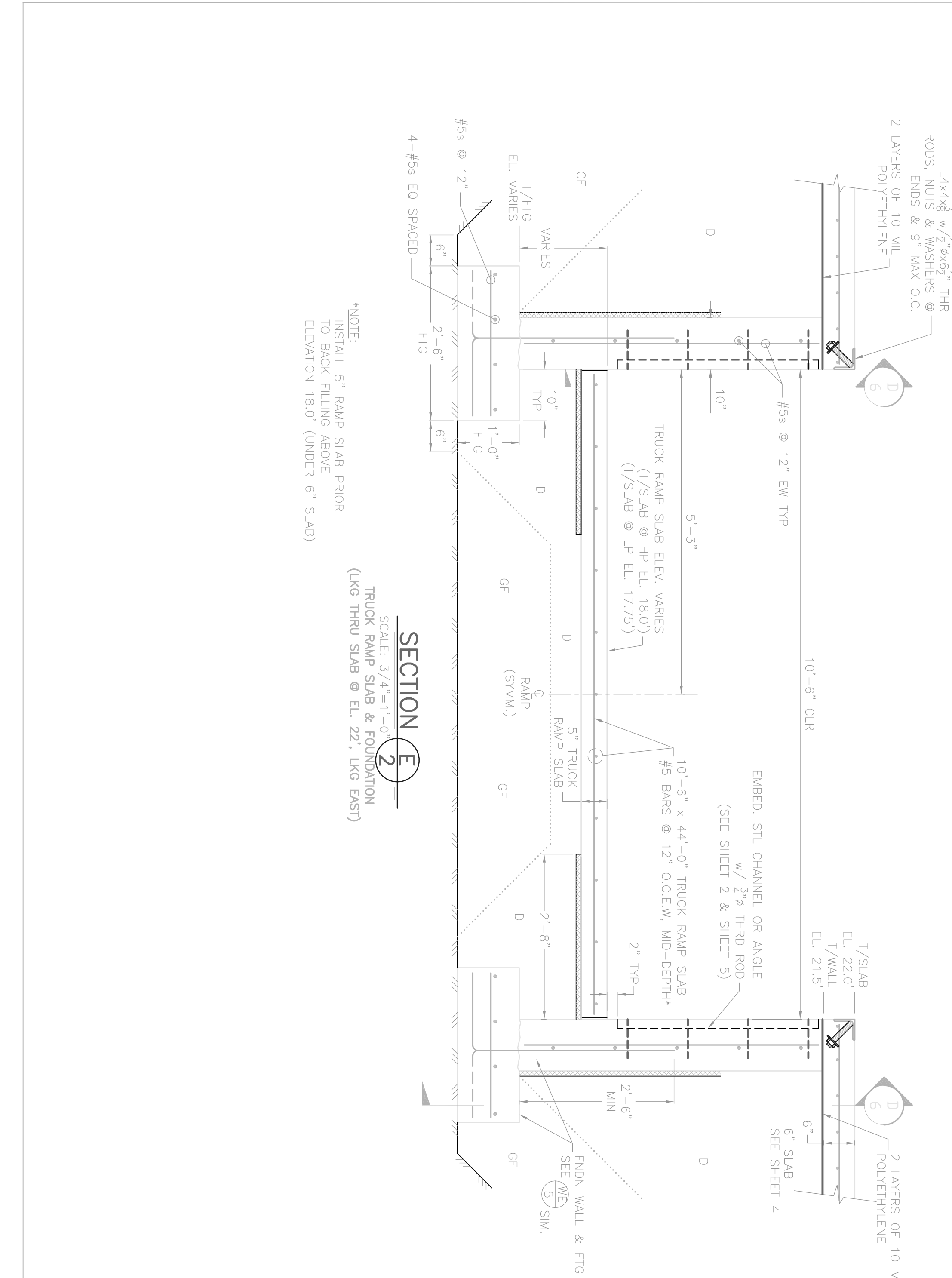

SECTION 6
SCALE: 1"=1'-0"
TRUCK RAMP DOOR NOTCH
(LKG DOWN)

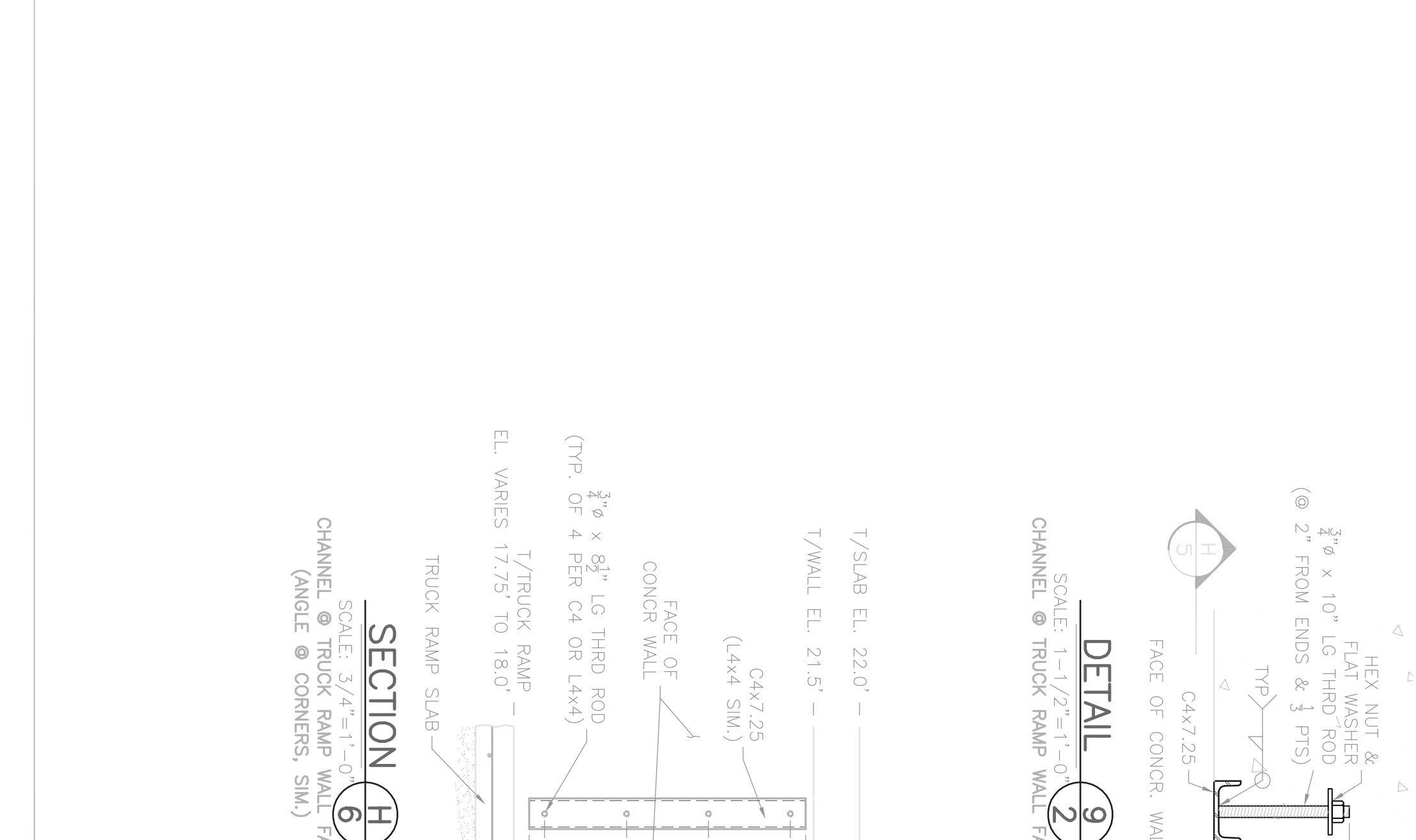

SECTION 2
SCALE: 3/4"=1'-0"
TRUCK RAMP SLAB & FOUNDATION
(LKG THRU SLAB @ EL. 22.0')

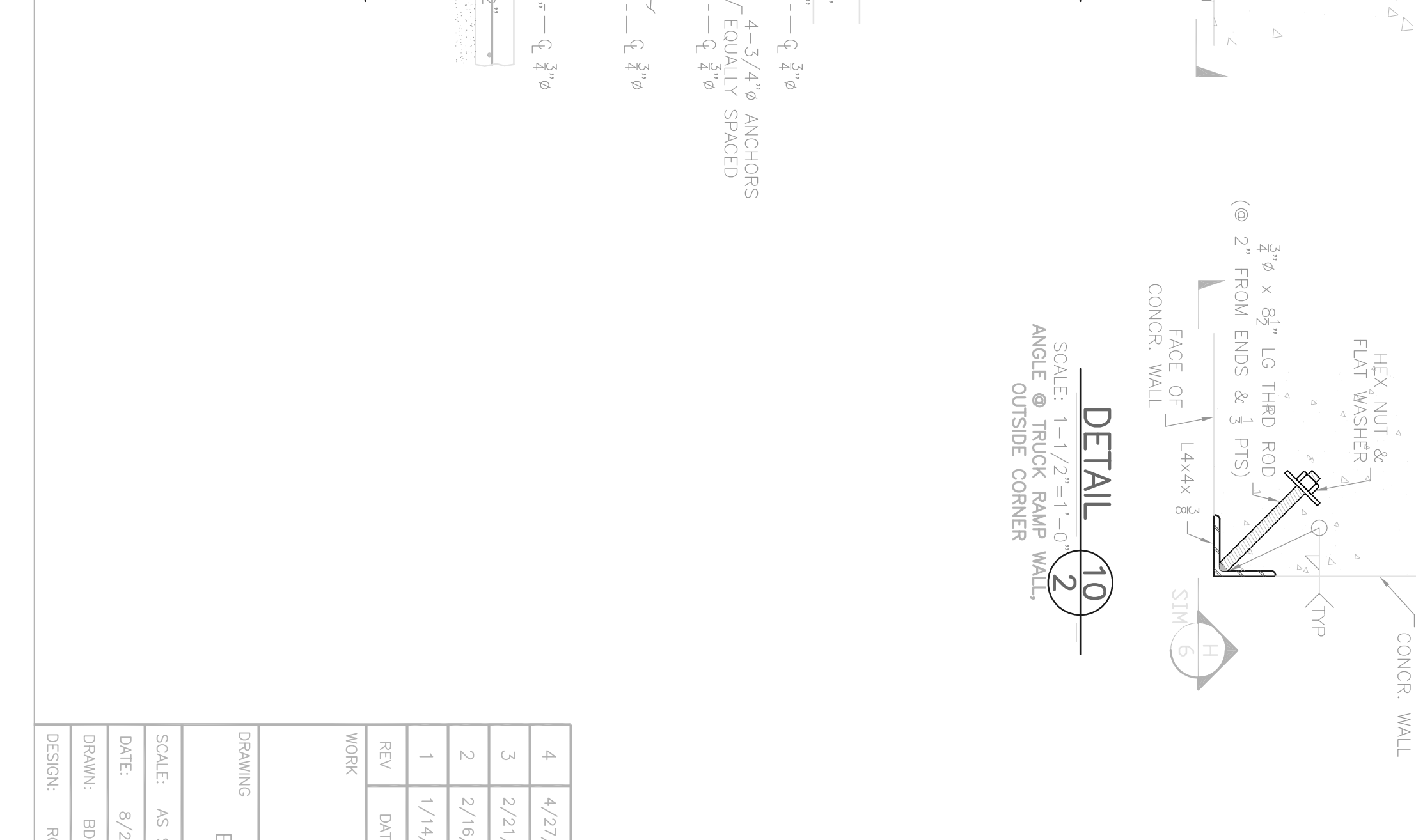

SECTION 5
SCALE: 3/4"=1'-0"
TRUCK RAMP SLAB & FOUNDATION
(LKG THRU SLAB @ EL. 22.0')

REV	DATE	BY	DESCRIPTION
1	1/14/05	RG	PERMIT PLAN
2	2/16/05	RG	CONSTRUCTION BID SET
3	2/21/05	RG	REVISIONS - CLIENT REQUEST
4	4/27/05	RG	FOR CONSTRUCTION

WORK
CANBRO CORPORATION
RUBB BUILDING VII

DRAWING
BACK-UP TRUCK DOCK & MISC. DETAILS

SCALE: AS SHOWN

DATE: 8/24/04

DRAWN: BDM

DESIGN: RG

SHEET: S6 OF 8

JOB: 407

GAGNON ENGINEERING, INC.
Structural Consultants
198 MAIN STREET
GIRIHAN, MAINE 04038