

5

4

3

2

1

D

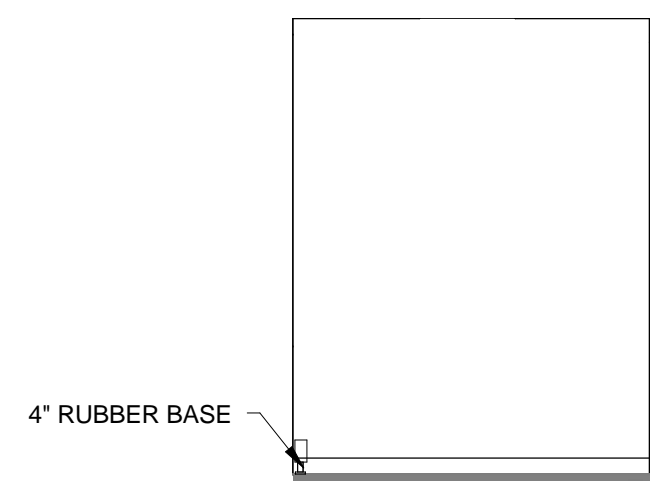

D4 OFFICE 1 - WEST
1/4" = 1'-0"

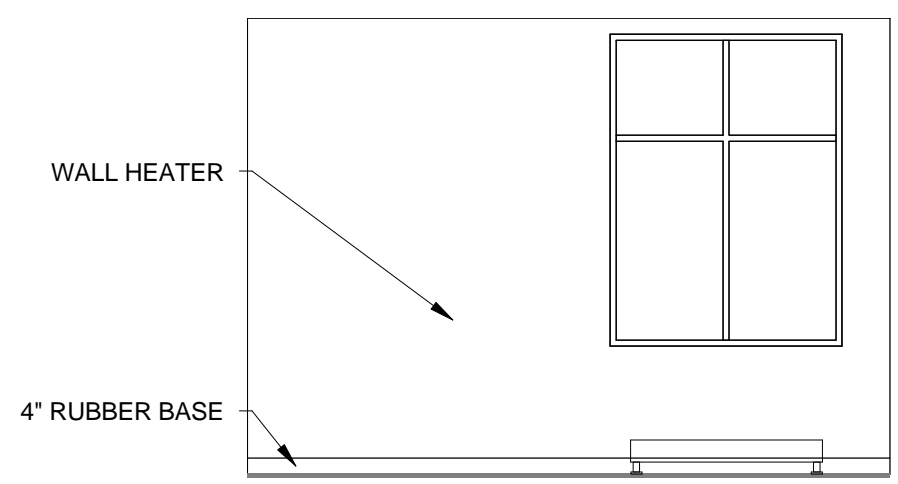

D3 OFFICE 1 - SOUTH
1/4" = 1'-0"

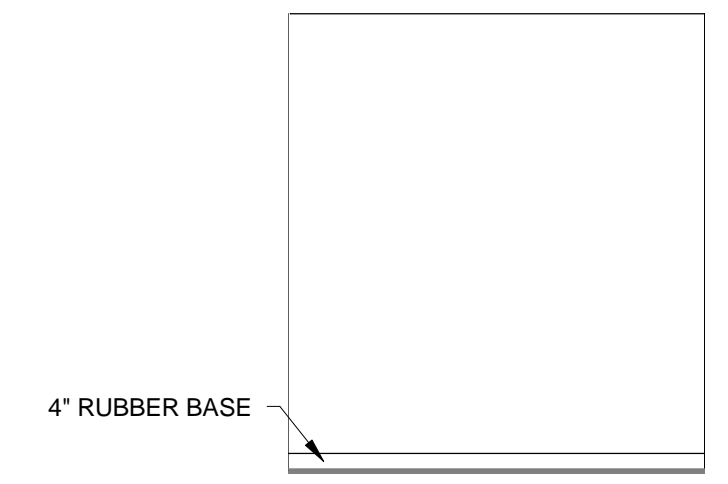

D2 OFFICE 1 - EAST
1/4" = 1'-0"

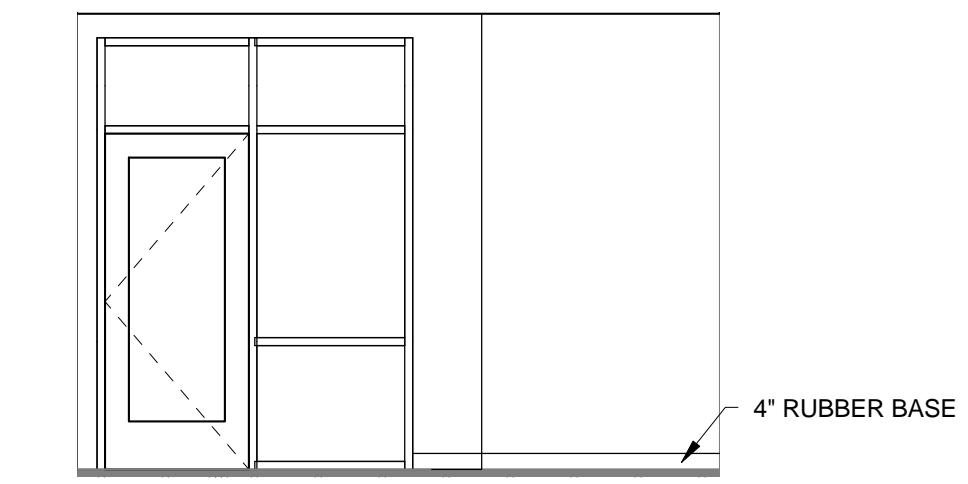

D1 OFFICE 1 - NORTH
1/4" = 1'-0"

C

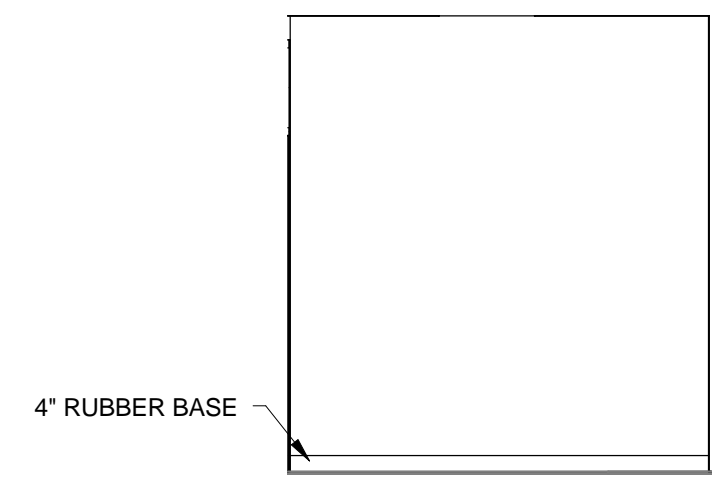

C4 OFFICE 4 - WEST
1/4" = 1'-0"

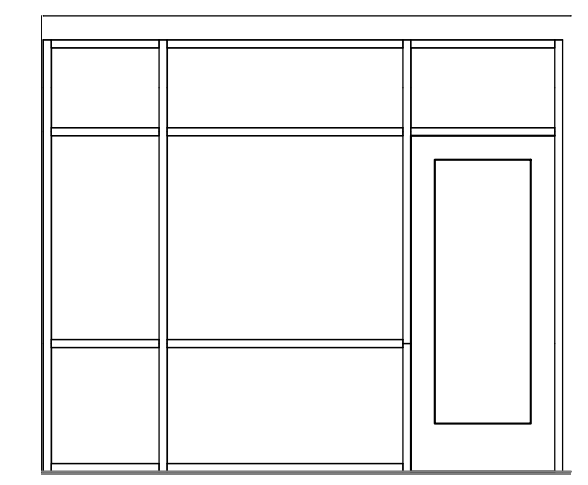

C3 OFFICE 4 - SOUTH
1/4" = 1'-0"

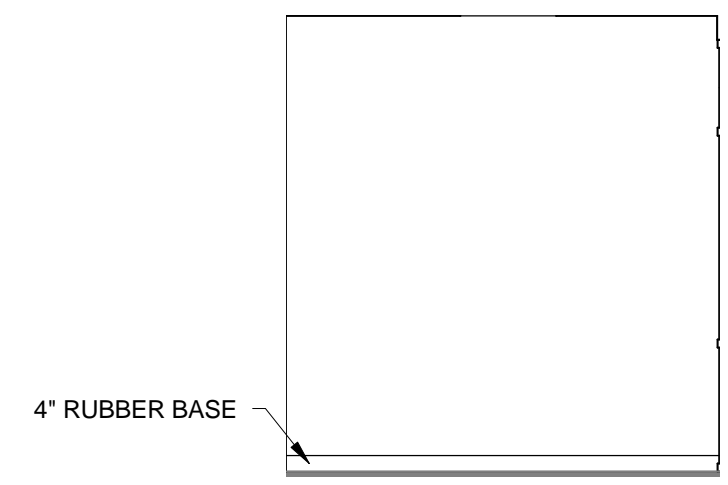

C2 OFFICE 4 - EAST
1/4" = 1'-0"

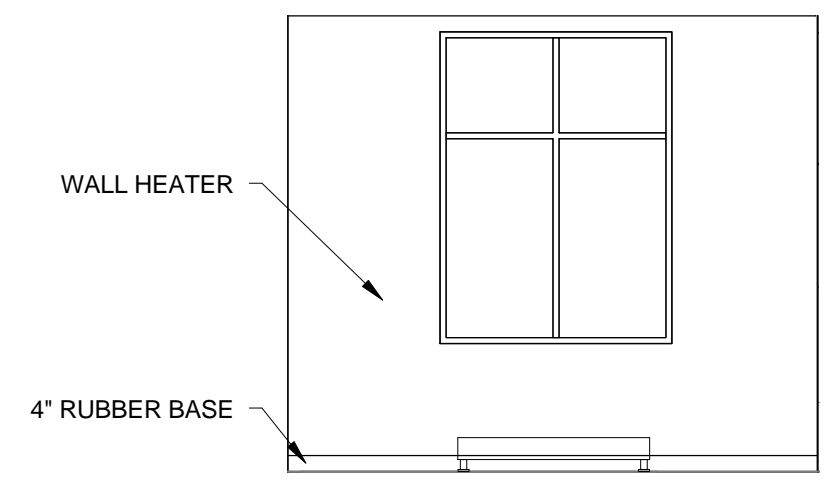

C1 OFFICE 4 - NORTH
1/4" = 1'-0"

B

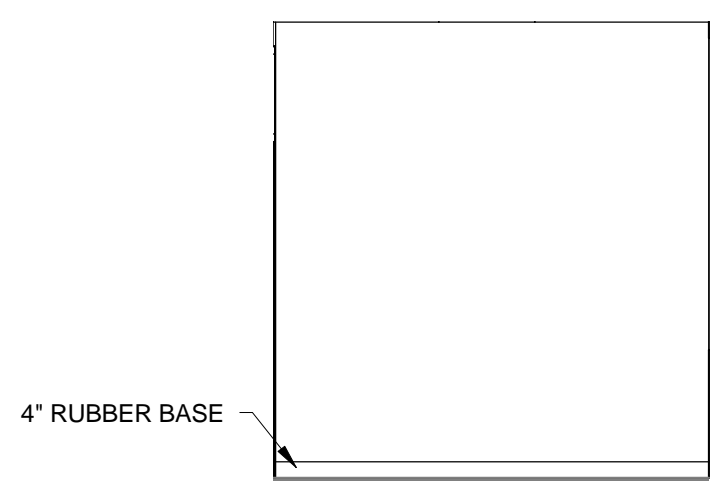

B4 OFFICE 3 - WEST
1/4" = 1'-0"

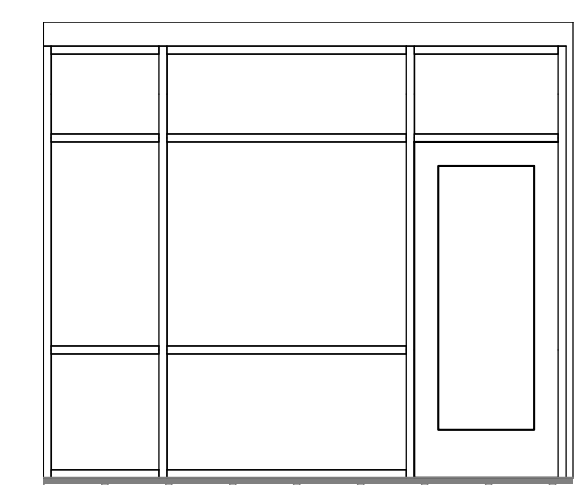

B3 OFFICE 3 - SOUTH
1/4" = 1'-0"

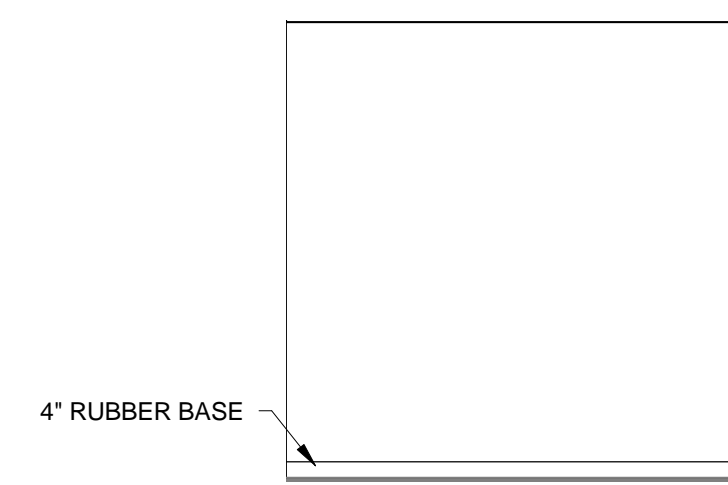

B2 OFFICE 3 - EAST
1/4" = 1'-0"

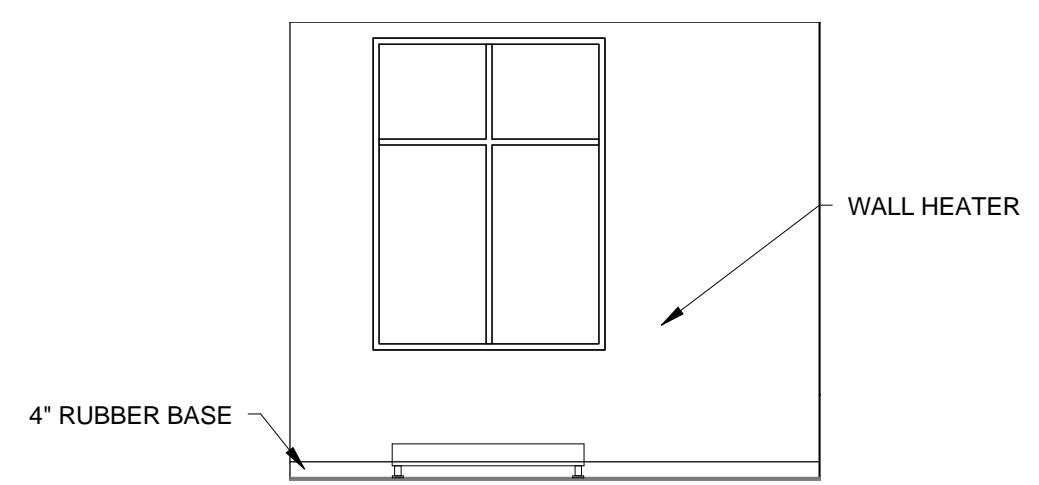

B1 OFFICE 3 - NORTH
1/4" = 1'-0"

A

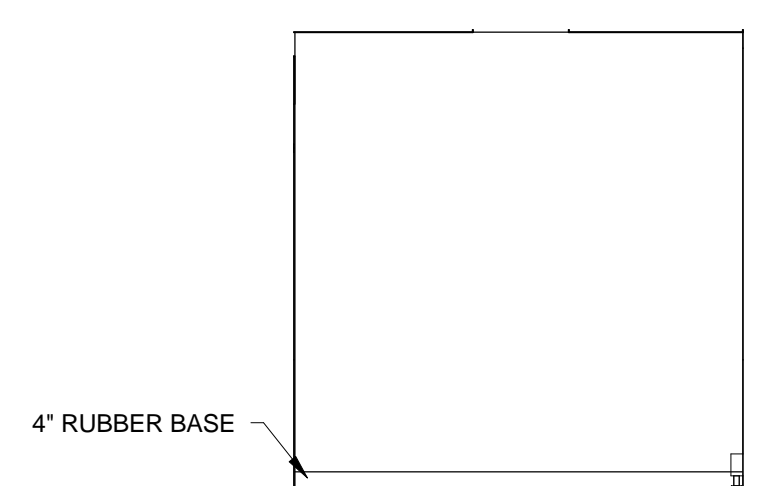

A4 OFFICE 2 - WEST
1/4" = 1'-0"

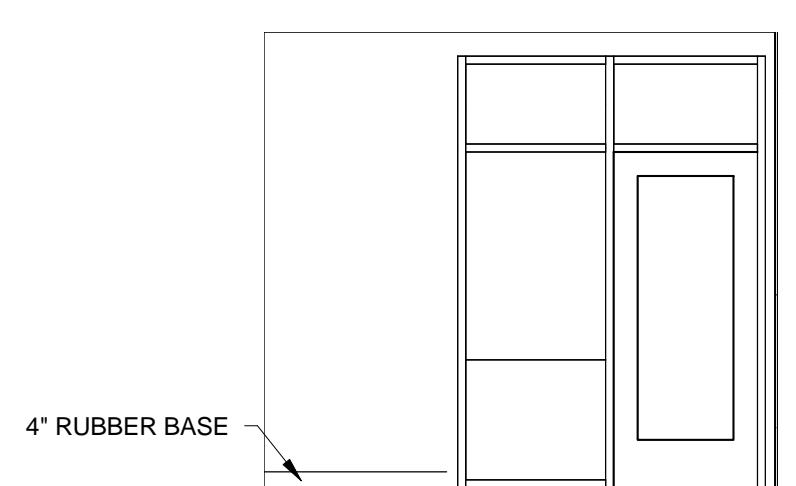

A3 OFFICE 2 - SOUTH
1/4" = 1'-0"

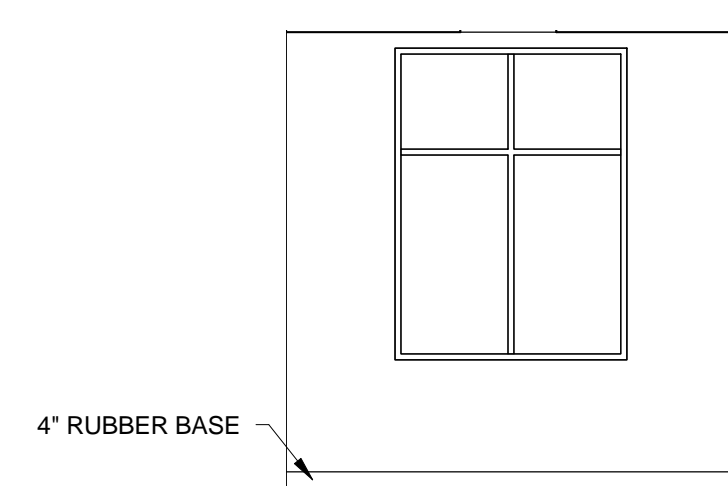

A2 OFFICE 2 - EAST
1/4" = 1'-0"

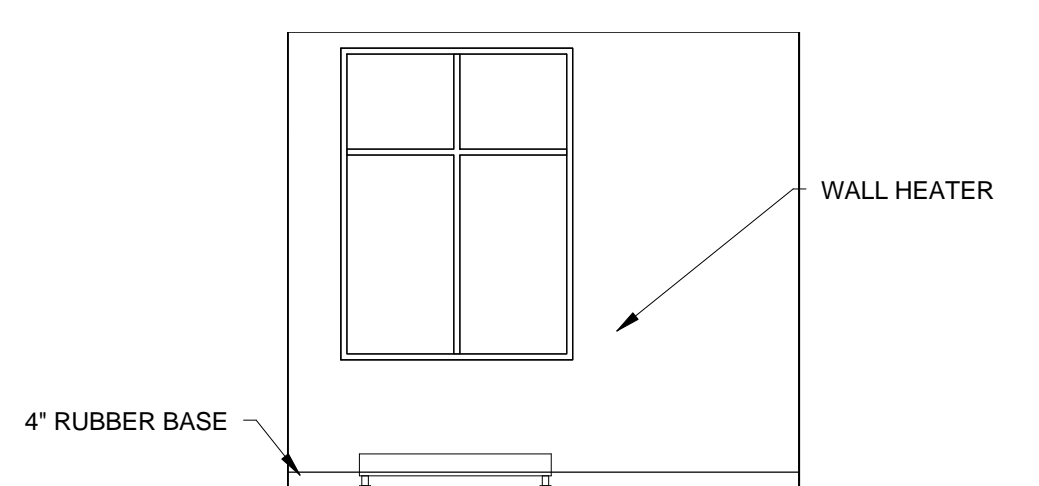

A1 OFFICE 2 - NORTH
1/4" = 1'-0"

5

4

3

2

1



PDT
ARCHITECTS

49 DARTMOUTH STREET
PORTLAND, MAINE 04101
207-775-1059
www.pdtarchts.com

COPYRIGHT
PDT Architects
Reuse or reproduction of the
contents of this document is not
permitted without written
permission of PDT Architects.

TruChoice FCU - 272 Park Avenue
272 Park Ave
Portland Maine 04041

JOB NO.
12042

DRWN. Author
CHK. Checker

SCALE:
1/4" = 1'-0"

ISSUE
04/26/2013

TITLE
INTERIOR
ELEVATIONS

SHEET
A202