

Revisions	date

project name
32 Thomas Street Apartments

project location
32 Thomas Street
Portland, Maine

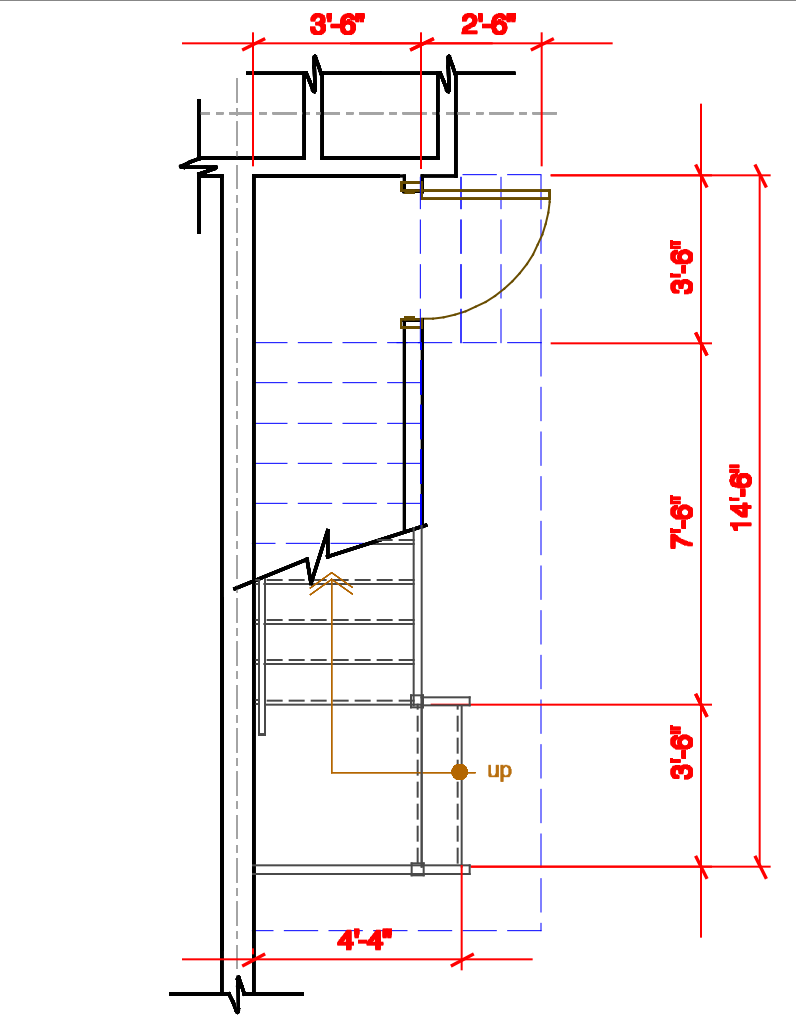
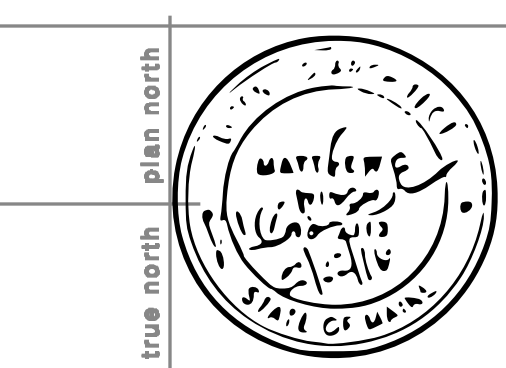

33 2nd Floor Plan
Scale: 1/4" = 1'-0"

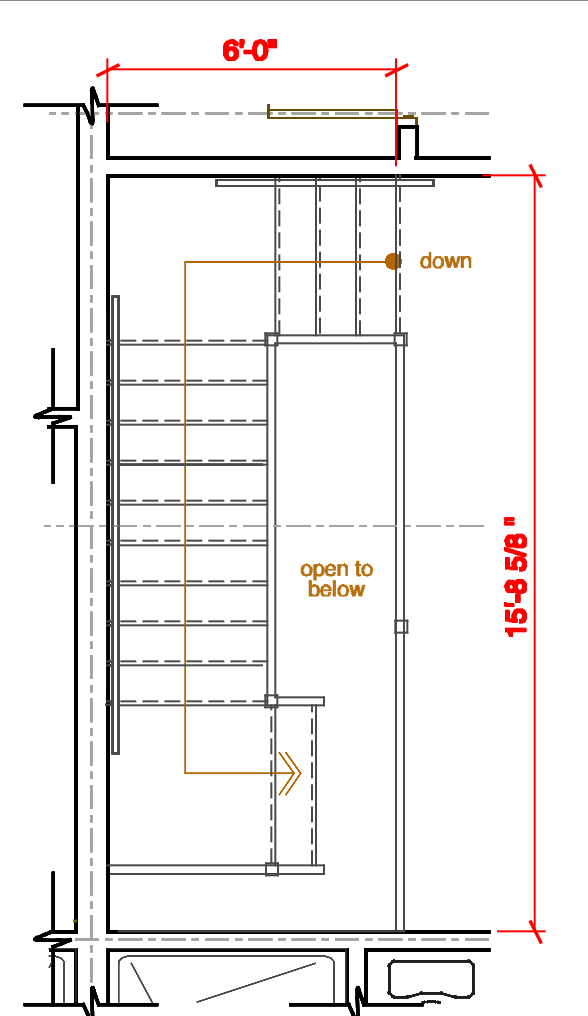

32 3rd Floor Plan
Scale: 1/4" = 1'-0"

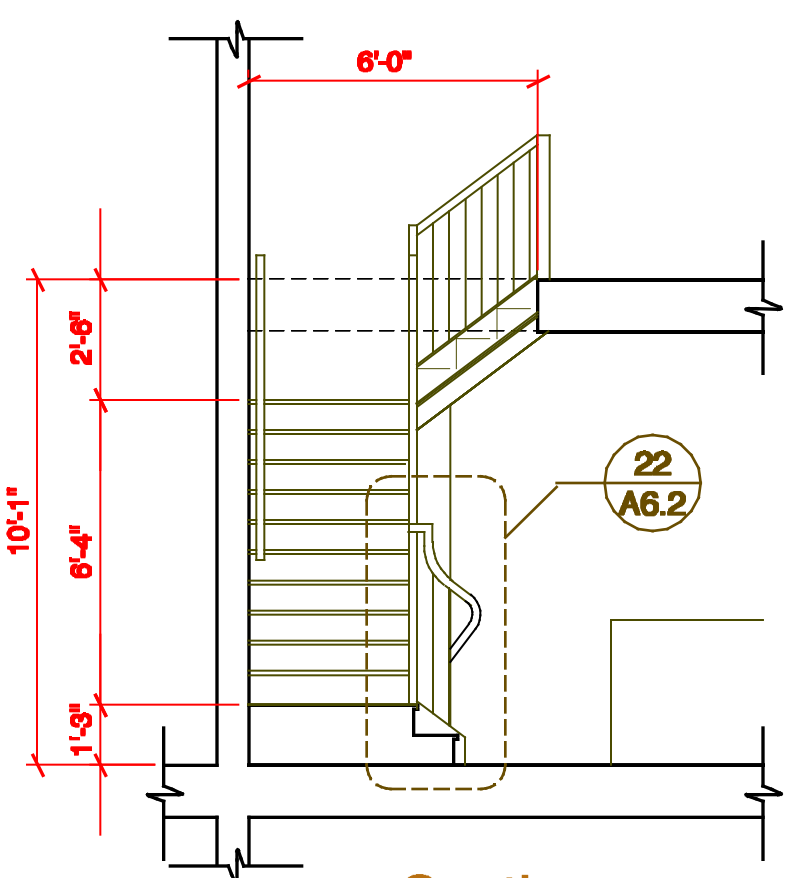

31 Section
Scale: 1/4" = 1'-0"

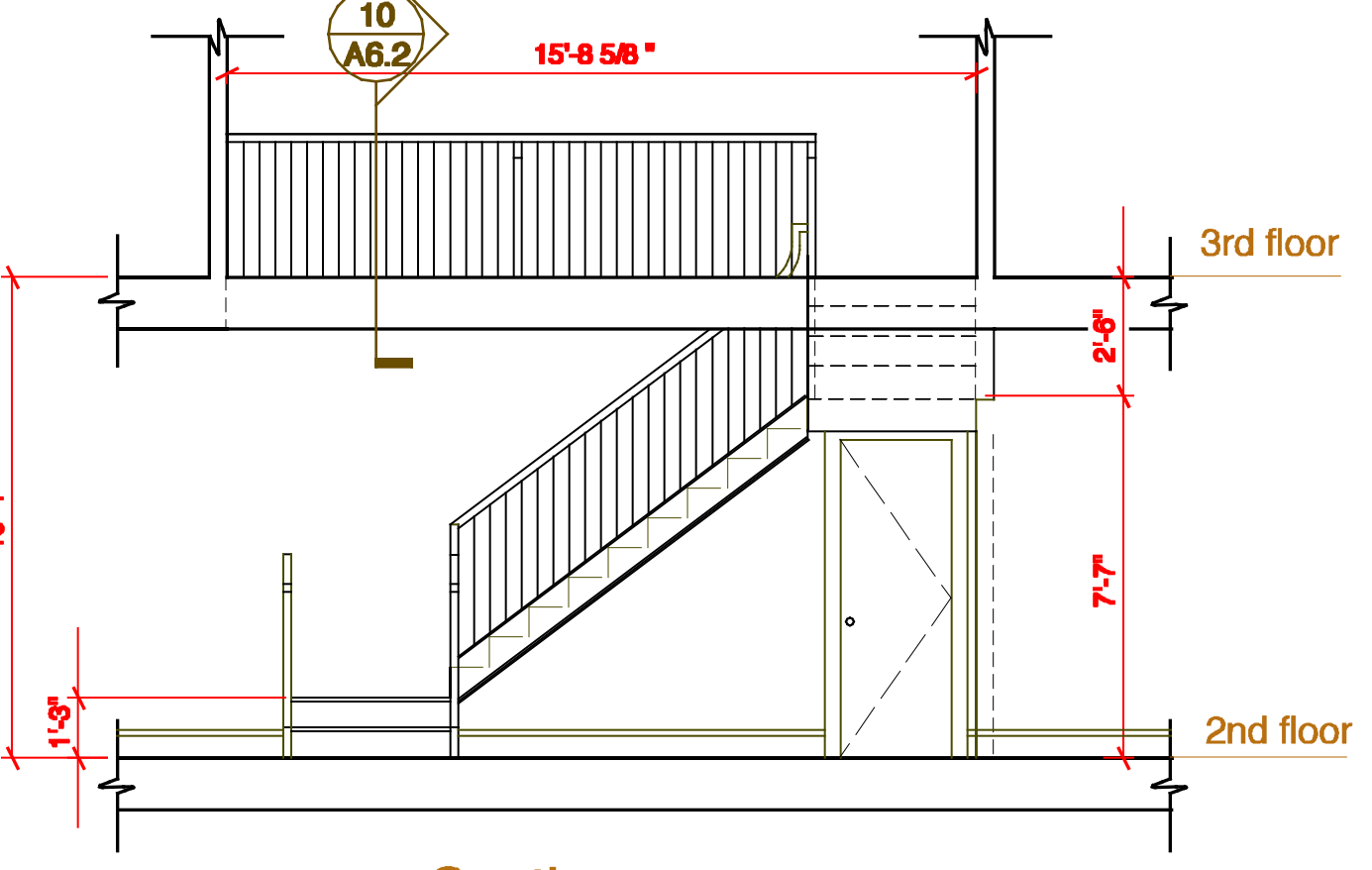

30 Section
Scale: 1/4" = 1'-0"

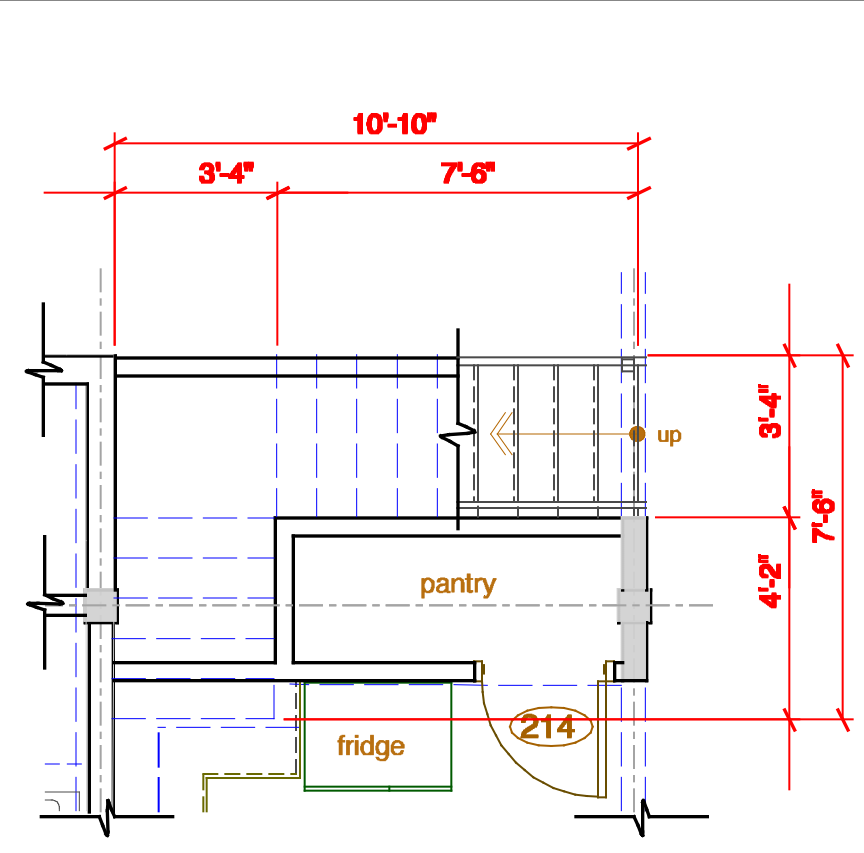

23 2nd Floor Plan
Scale: 1/4" = 1'-0"

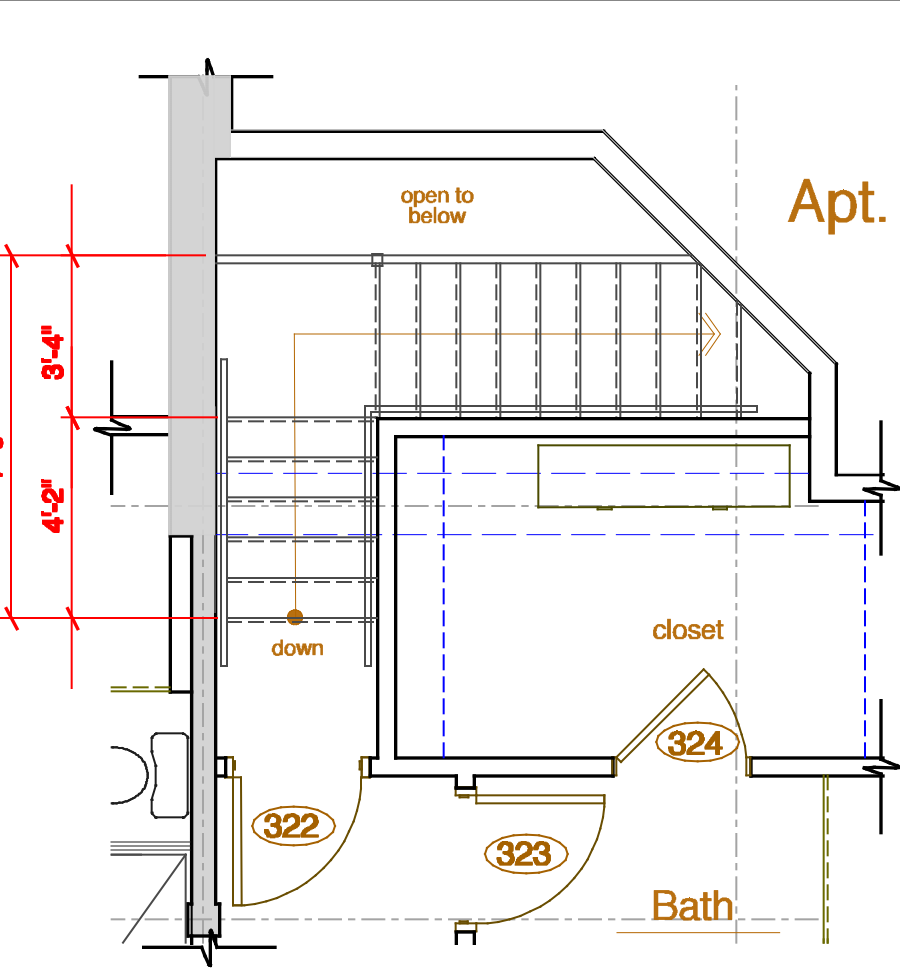

22 3rd Floor Plan
Scale: 1/4" = 1'-0"

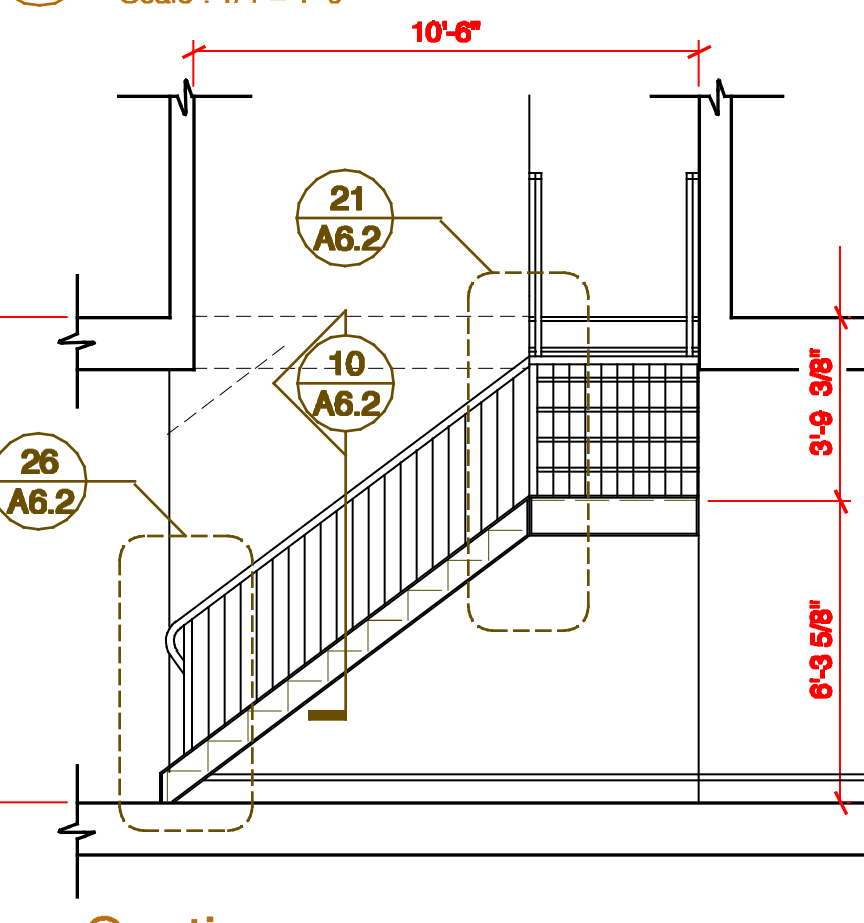

21 Section
Scale: 1/4" = 1'-0"

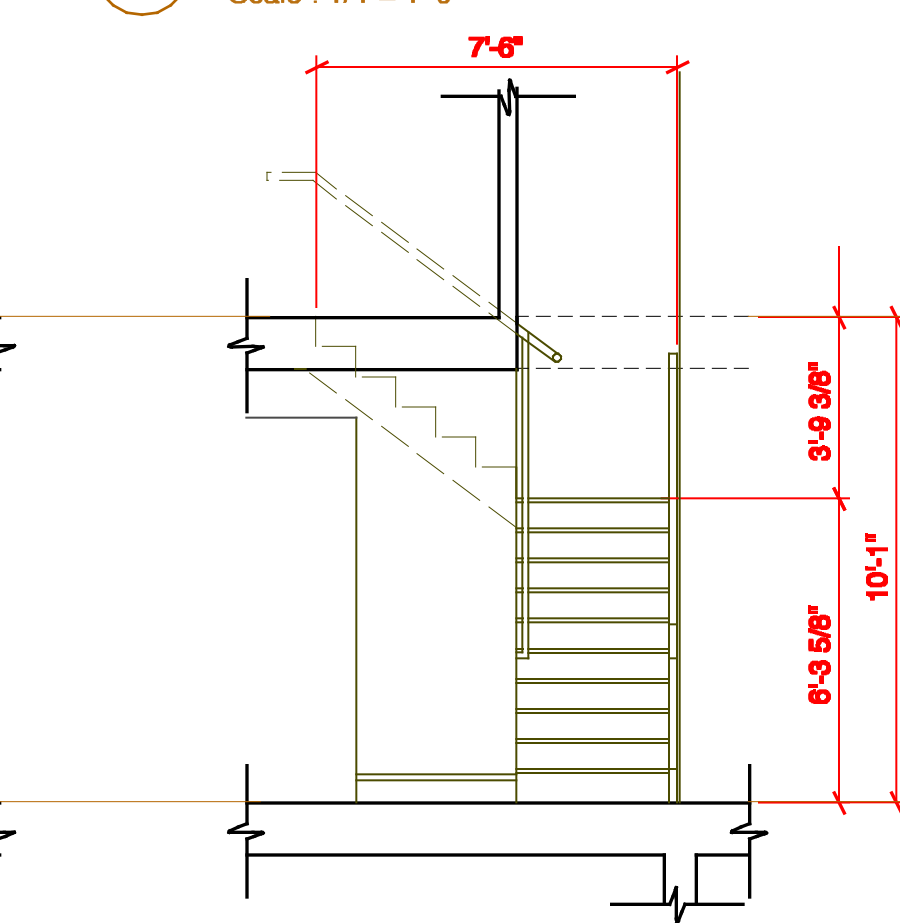

20 Section
Scale: 1/4" = 1'-0"

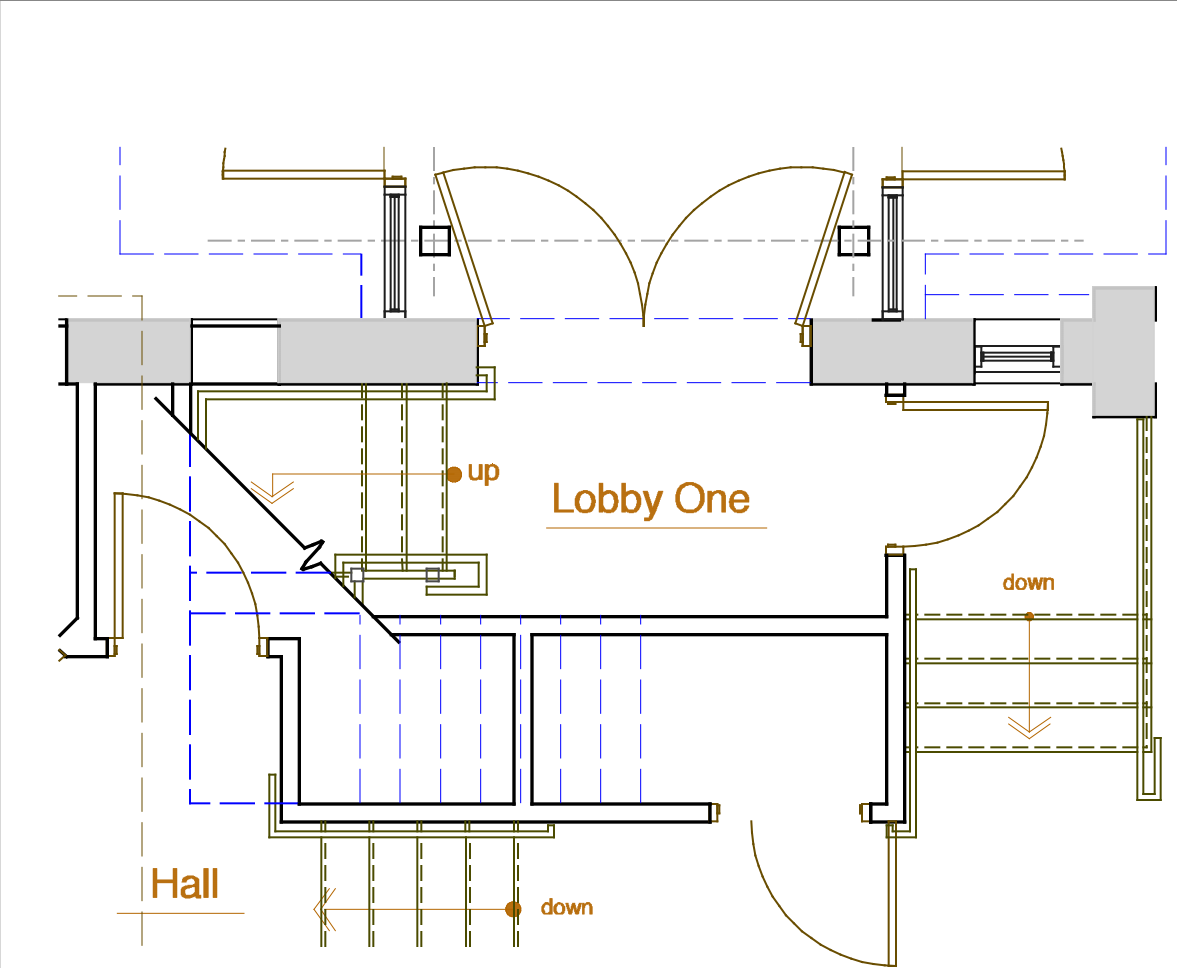

12 1st Floor Plan
Scale: 1/4" = 1'-0"

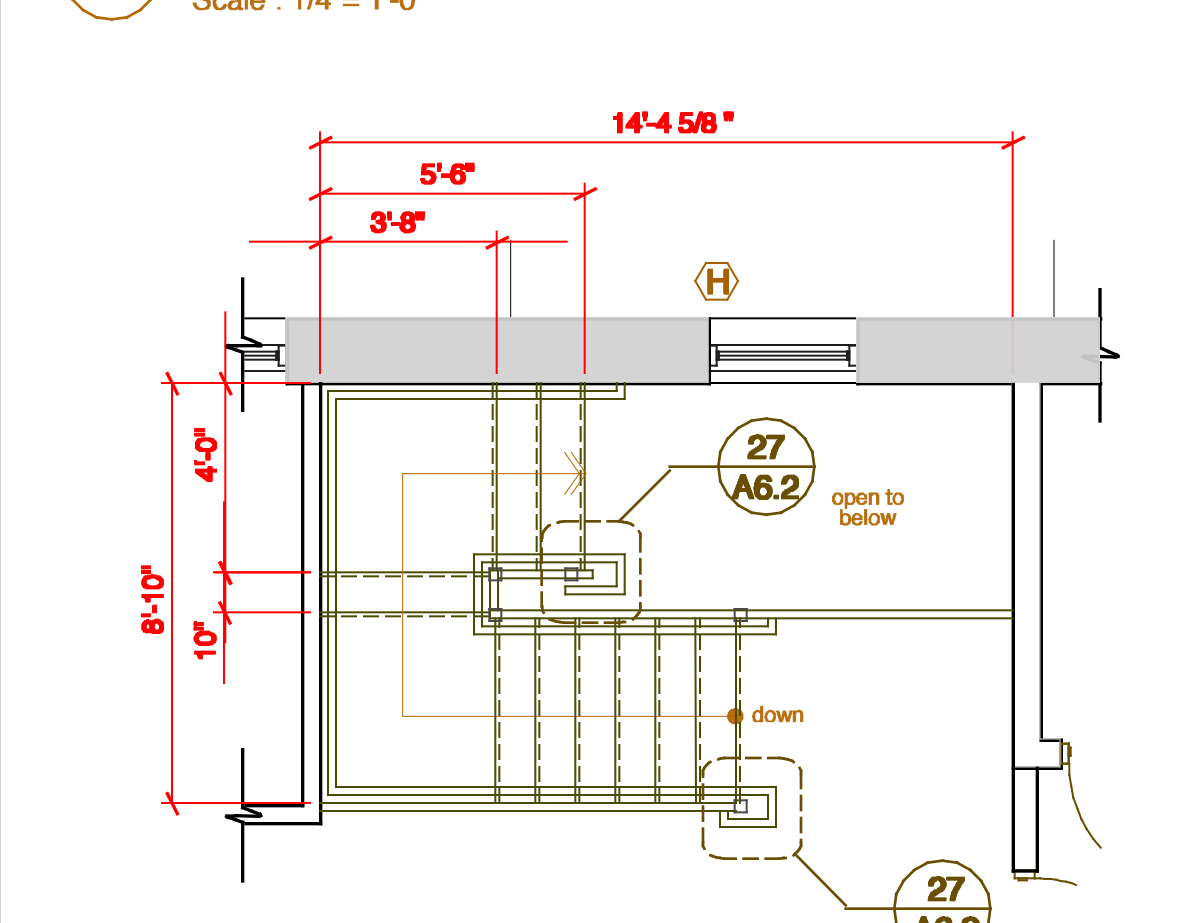

11 2nd Floor Plan
Scale: 1/4" = 1'-0"

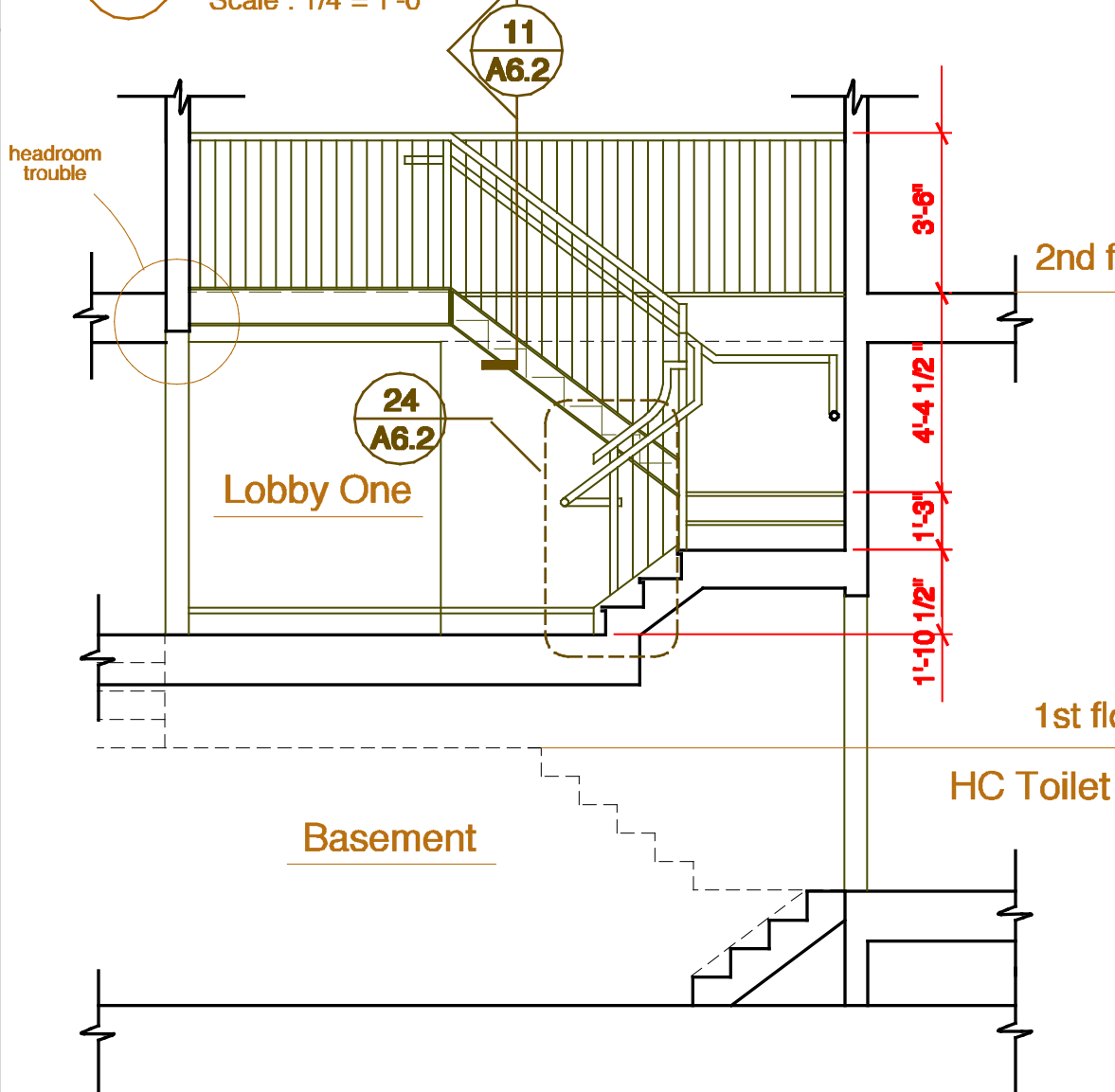

10 Section
Scale: 1/4" = 1'-0"

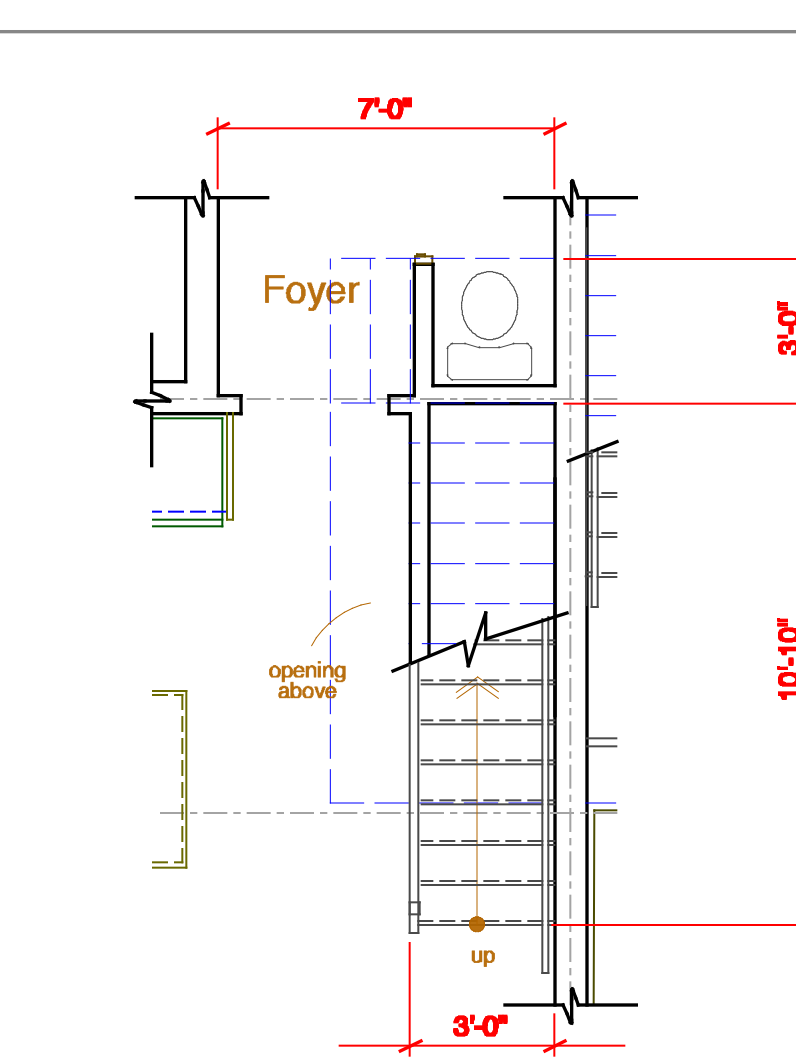

43 2nd Floor Plan
Scale: 1/4" = 1'-0"

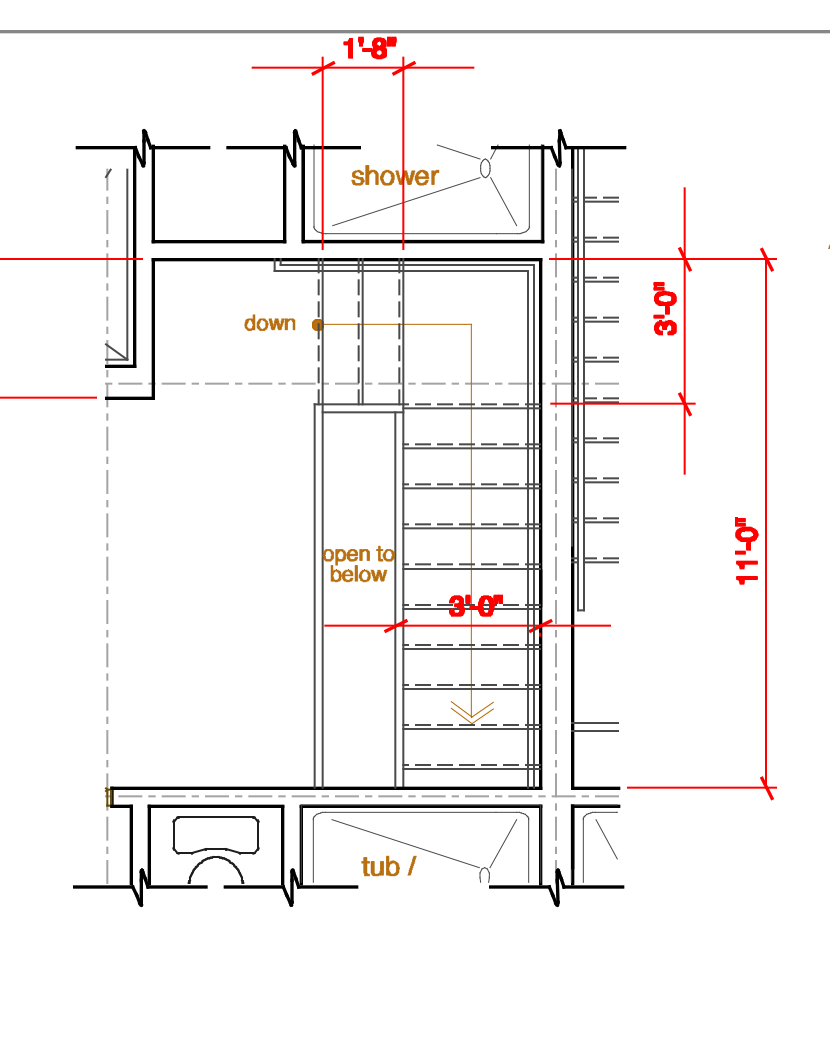

42 3rd Floor Plan
Scale: 1/4" = 1'-0"

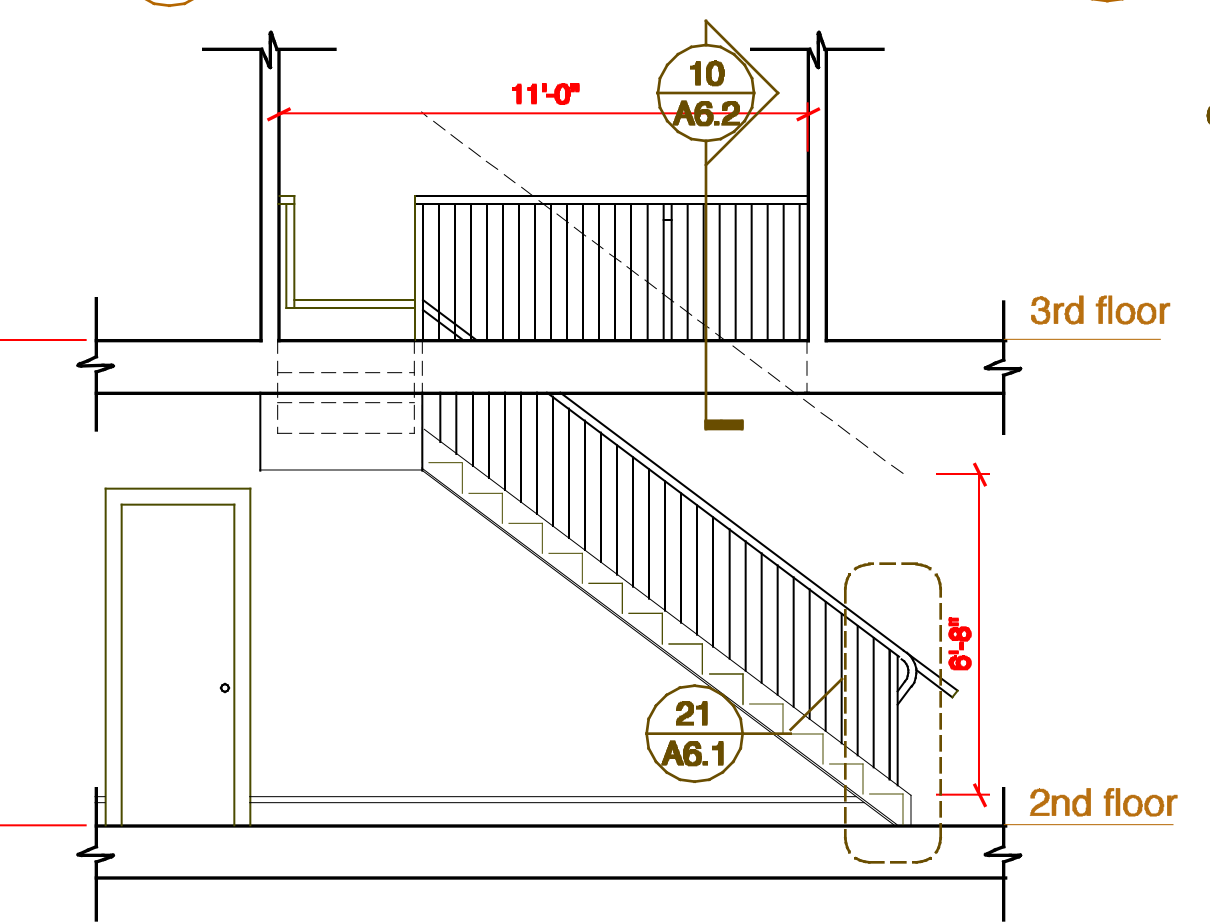

41 Section
Scale: 1/4" = 1'-0"

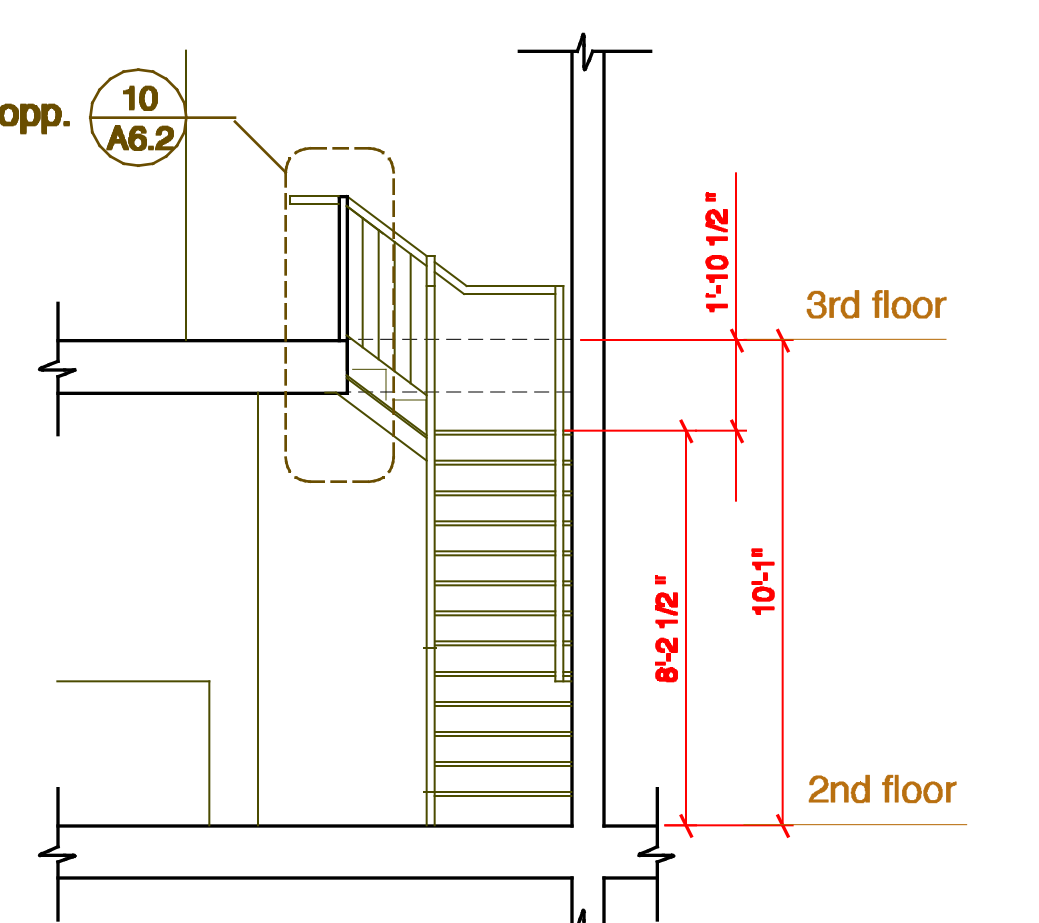

40 Section
Scale: 1/4" = 1'-0"

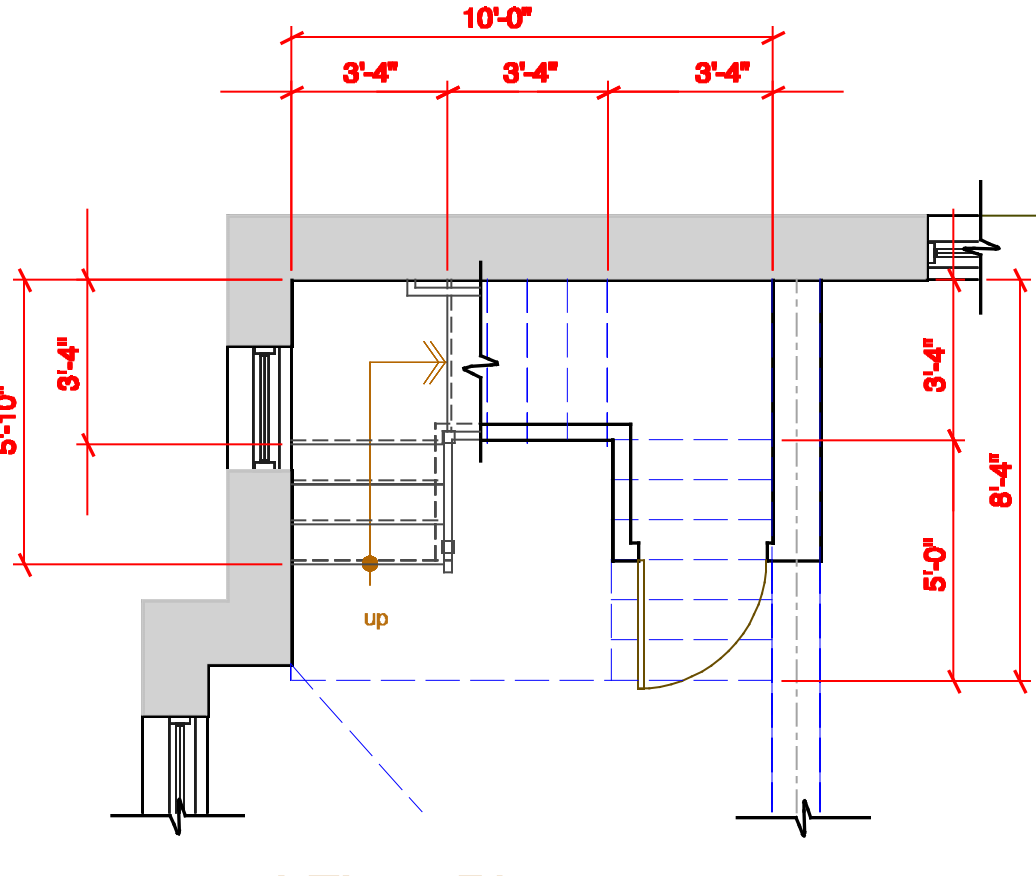

53 2nd Floor Plan
Scale: 1/4" = 1'-0"

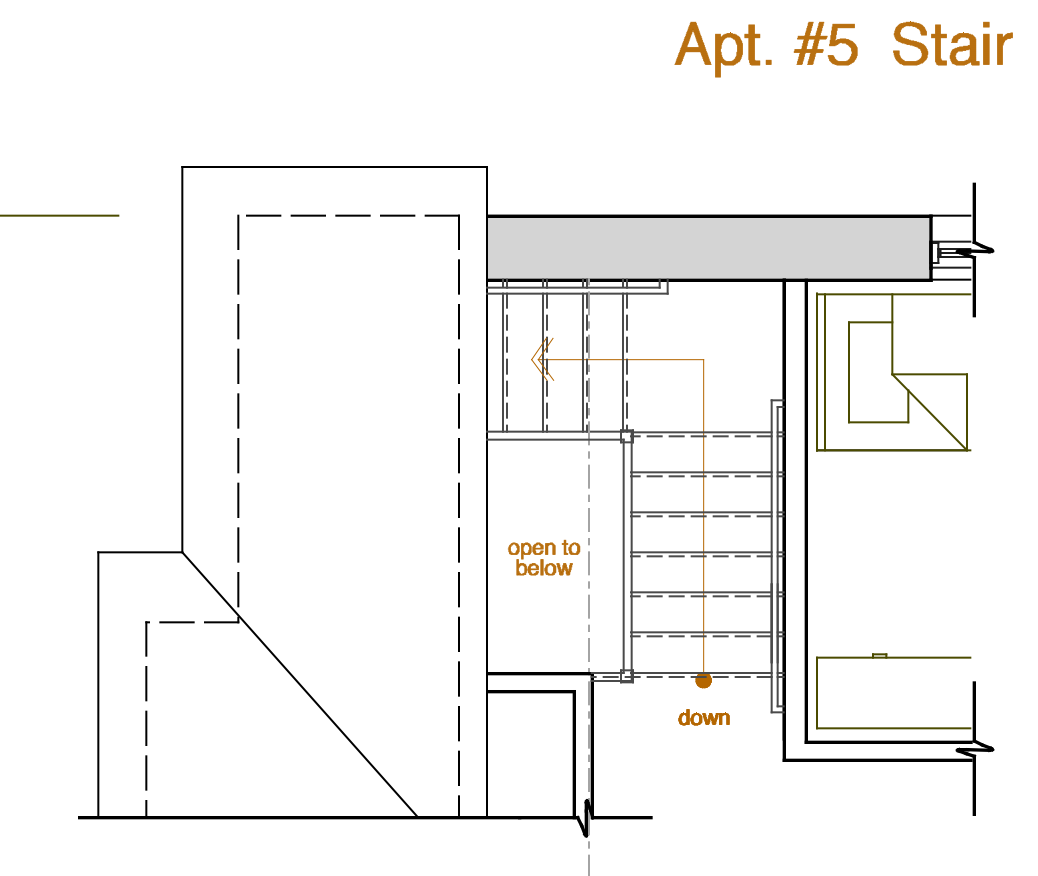

52 3rd Floor Plan
Scale: 1/4" = 1'-0"

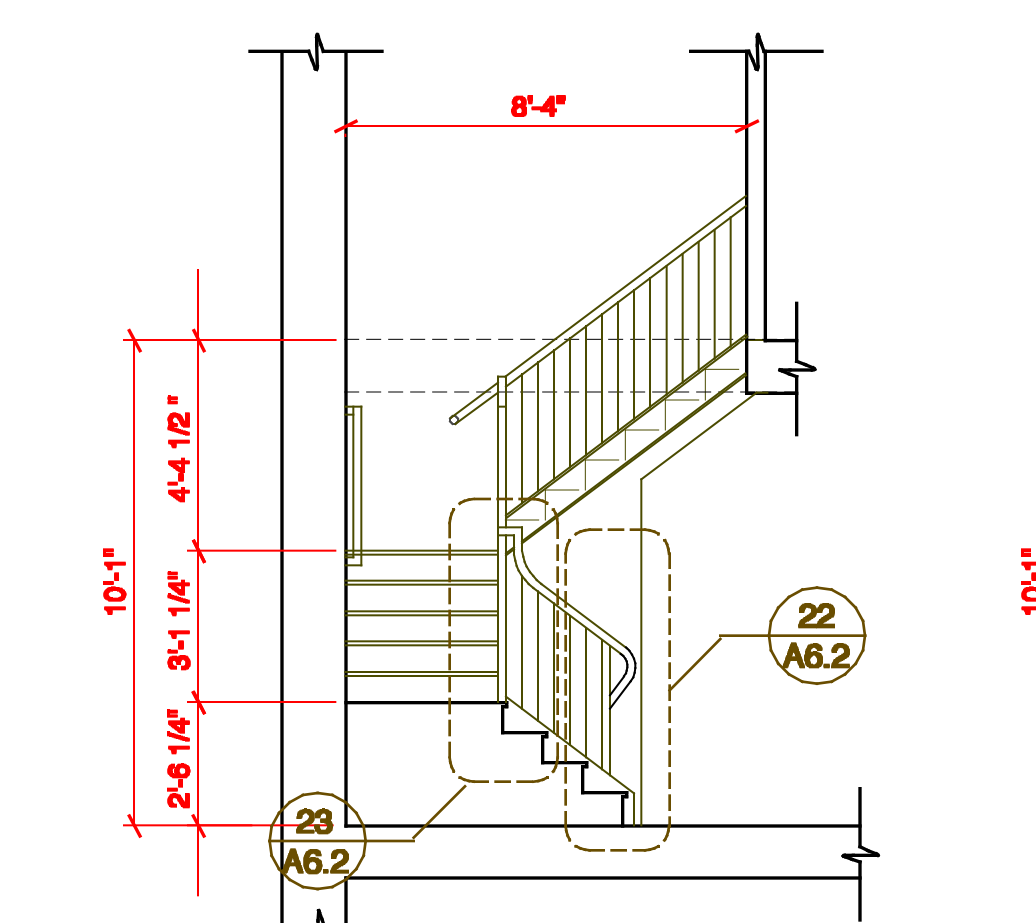

51 Section
Scale: 1/4" = 1'-0"

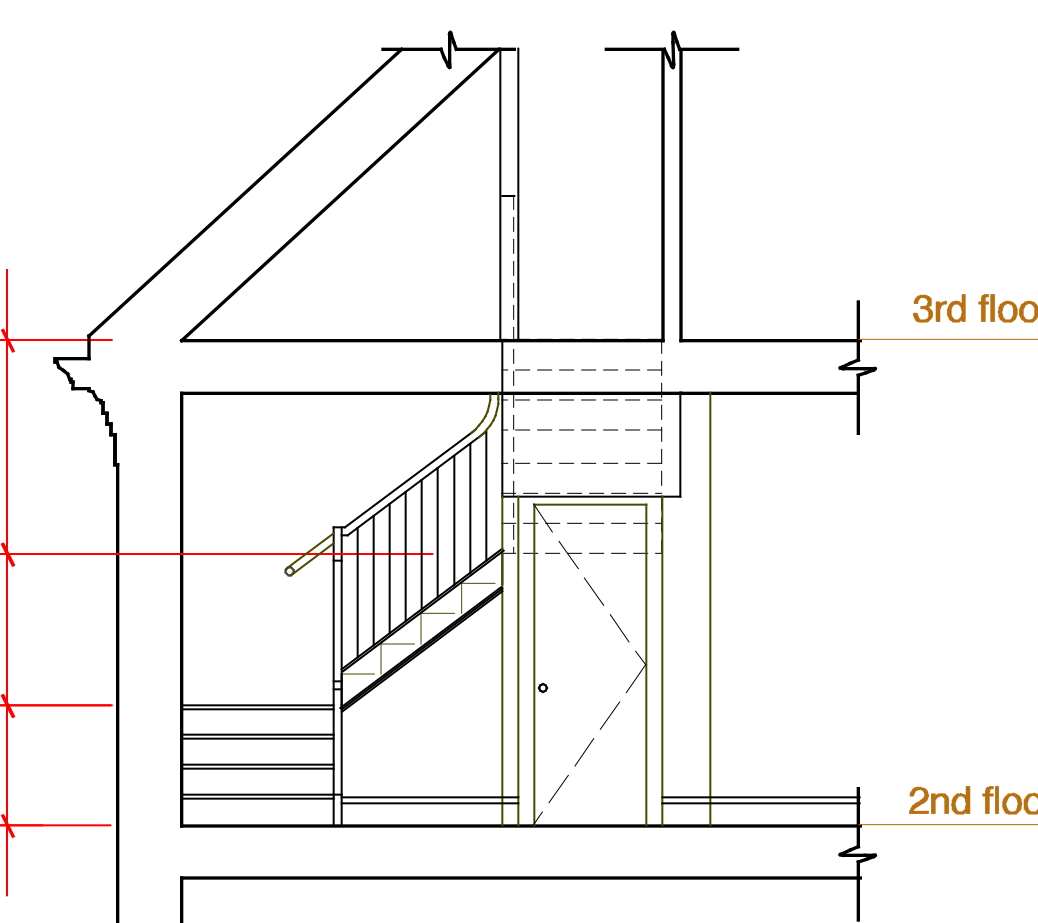

50 Section
Scale: 1/4" = 1'-0"

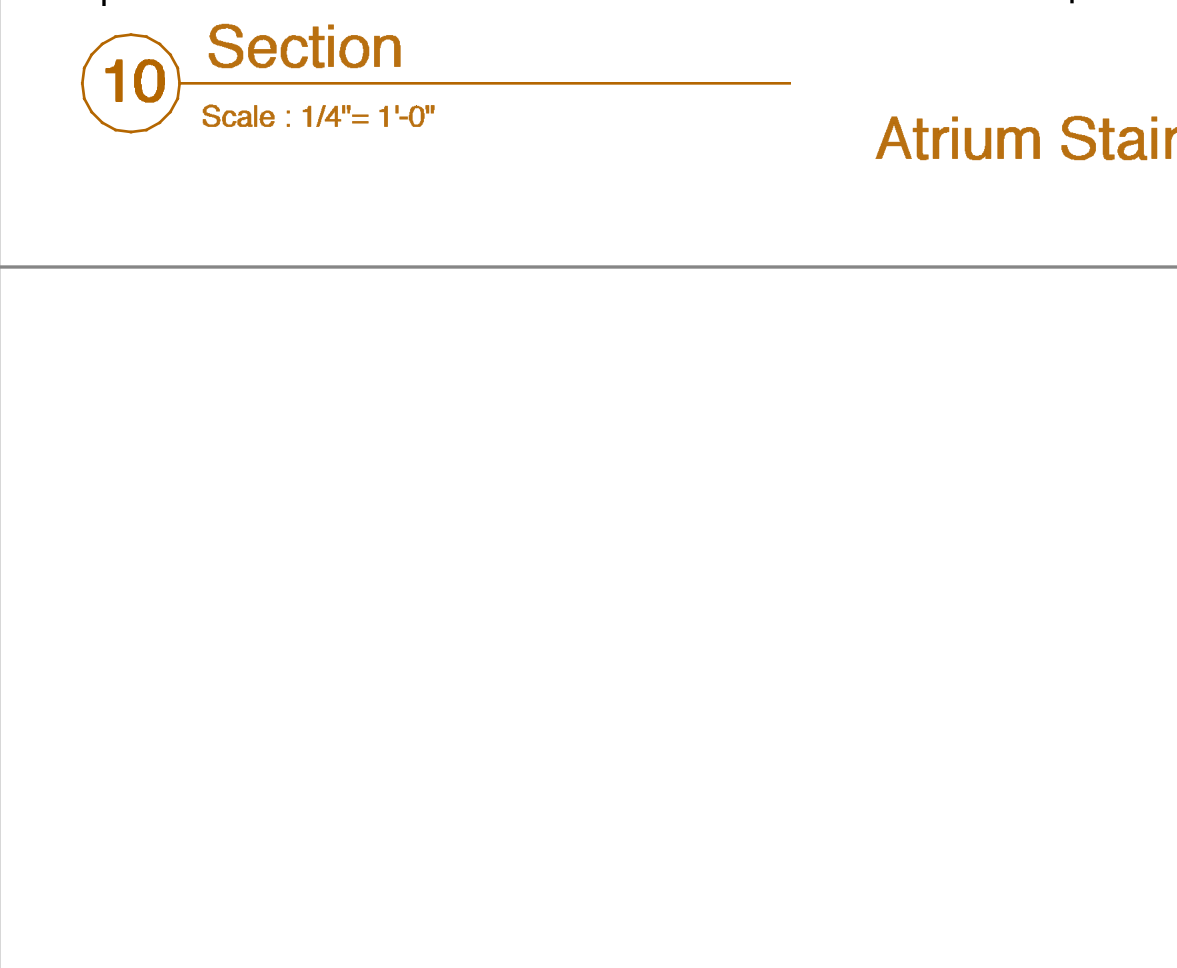

10 Section
Scale: 1/4" = 1'-0"