

CB# 061-C-009

STATE OF MAINE CHIMNEY OR FIREPLACE CONSTRUCTION/INSTALLATION DISCLOSURE

Dear Consumer: State law, specifically 32 M.R.S.A. § 2313-A, requires that chimney or fireplace installers, as of January 1, 1992, provide you with this "Disclosure" prior to the installation or construction of your chimney or fireplace. The purpose of this Disclosure is to inform you that the National Fire Protection Standard #211 (NFPA #211) is the current standard which applies to all new construction of chimneys and fireplaces. Please note that the State of Maine does not require registration or licensure of chimney or fireplace installers. It is important to realize that many fires are caused each year from improperly constructed fireplaces and chimneys. This disclosure form should help you in making an informed decision as to the abilities of the installer and under what requirements the installation must comply.

INSTALLER INFORMATION

Name of Installer:		D/B/A:	
Name of Installer (if incorporated): <i>Pine State B + H.</i>		D/B/A: <i>JAN 23 2009</i>	
Legal Address: <i>5 Industry Rd.</i>			
City: <i>South Portland</i>	State: <i>ME</i>	Zip Code: <i>04106</i>	
County: <i>Comberland</i>		Home Telephone: () -	
		Work Telephone: <i>(207) 883-1200</i>	
Years of experience doing fireplace or chimney installations: <i>13 years</i>			

CONSUMER INFORMATION

Name of Consumer: <i>Mark Jarrell</i>		
Mailing Address: <i>321 Spring St</i>		
City: <i>Portland</i>	State: <i>ME</i>	Zip Code: <i>04102</i>
County: <i>Comberland</i>		Home Telephone: () <i>522-0044</i>
		Work Telephone: () -

Installer, please give a brief description of installation being offered: *Removed Brick flue for gas stove install B-Vent Chimney*

I hereby attest that the preceding information provided is true to the best of my knowledge. I also understand that if I fail to conform with the standards as outlined in NFPA #211 that I shall be subject to penalties as outlined in Title 32, M.R.S.A., Chapter 33 and the Oil and Solid Fuel Board Rules.

Signature of Installer: *[Signature]* Date: *1-23-09*

GAS VENT

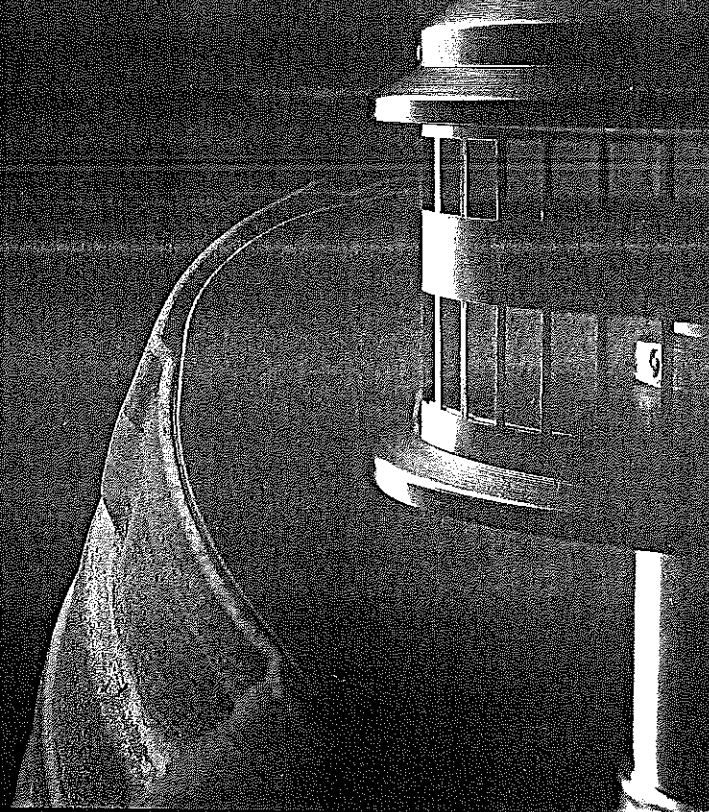

GAS VENT SYSTEMS

TYPE B GAS VENT
DURA/CONNECT®
DURAFLEX®



Engineered Excellence®

SIMPSON**Dura-Vent**

Round Gas Vent

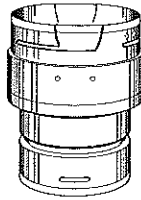
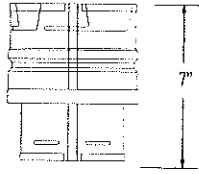

Increases

Size	Stock #	Order #	7" x 8"	7GVX8	108
3" x 4"	3GVX4	100	8" x 10"	8GVX10	109
3" x 5"	3GVX5	101	8" x 12"	8GVX12	110
3" x 6"	3GVX6	102	10" x 12"	10GVX12	111
3" x 7"	3GVX7	112	** x 14"	**GVX14	209
4" x 5"	4GVX5	103	** x 16"	**GVX16	219
4" x 6"	4GVX6	104	** x 18"	**GVX18	229
4" x 7"	4GVX7	113	** x 20"	**GVX20	239
4" x 8"	4GVX8	116	** x 22"	**GVX22	249
5" x 6"	5GVX6	105	** x 24"	**GVX24	259
5" x 7"	5GVX7	115	** x 26"	**GVX26	269
5" x 8"	5GVX8	117	** x 28"	**GVX28	279
6" x 7"	6GVX7	106	** x 30"	**GVX30	289
6" x 8"	6GVX8	107			

 Additional sizes available.

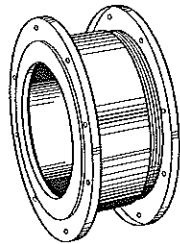
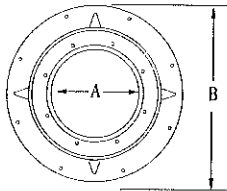

Adjusts out 3 1/2 to 6 inches.

Wall Thimbles

Size	Stock #	Order #	A	B
3"	3GVWT	160	3 3/4"	7 1/2"
4"	4GVWT	161	4 3/4"	8 1/2"
5"	5GVWT	162	5 3/4"	9 1/2"
6"	6GVWT	163	6 3/4"	10 1/2"
7"	7GVWT	164	7 3/4"	11 1/2"
8"	8GVWT	165	8 3/4"	12 1/2"

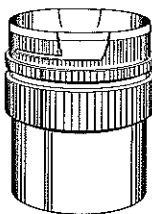
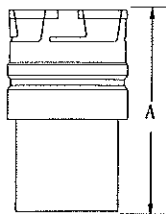

Draft Hood Connectors

Size	Stock #	Order #	A	14"	14GVC	190	10"
3"	3GVC	120	4 1/2"	16"	16GVC	191	10
4"	4GVC	121	4 1/2"	18"	18GVC	192	12
5"	5GVC	122	4 1/2"	20"	20GVC	193	12
6"	6GVC	123	4 1/2"	22"	22GVC	194	14
7"	7GVC	124	7	24"	24GVC	195	14
8"	8GVC	125	7	26"	26GVC	269	16 1/2
10"	10GVC	126	7	28"	28GVC	279	16 1/2
12"	12GVC	127	7	30"	30GVC	289	16 1/2

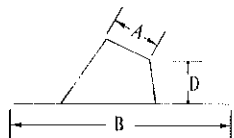
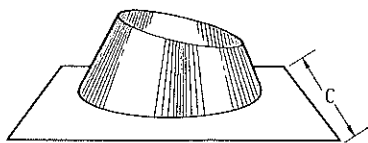

Accommodates flat to 6/12 roof pitches.



Steep Roof Flashing

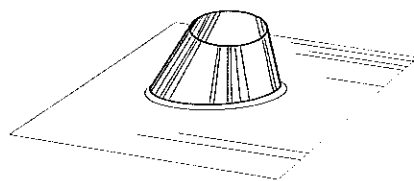

Accommodates flat to 7/12 to 12/12 roof pitch.

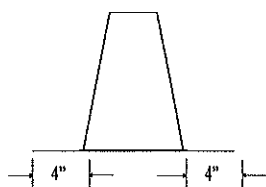
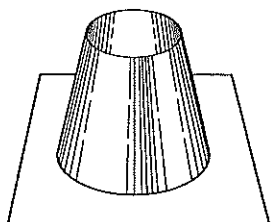

Tall Cone Flashing

For flat roof tops.

Adjustable Roof Flashings

Size	Stock #	Order #	A	B	C
3"	3GVF	140	3 5/8"	18 3/8"	16"
4"	4GVF	141	4 5/8"	18 3/8"	17"
5"	5GVF	142	5 5/8"	20"	18 3/8"
6"	6GVF	143	6 3/4"	21 1/2"	19 1/4"
7"	7GVF	144	7 3/4"	22 1/2"	21 1/2"
8"	8GVF	145	8 3/4"	23 1/2"	21 1/2"
10"	10GVF	146	11 3/8"	24"	24"
12"	12GVF	147	13 1/2"	24"	24"

14"	14GVF	280	15"	31 1/2"	29 1/2"
16"	16GVF	281	17"	36"	33 1/2"
18"	18GVF	282	20"	43"	40"
20"	20GVF	283	22"	43"	40"
22"	22GVF	284	24"	45"	41 9/16"
24"	24GVF	285	26"	45"	44 3/4"
26"	26GVF	286	28"	44 3/4"	44 3/4"
28"	28GVF	287	30"	50"	50"
30"	30GVF	288	32"	52"	52"

Steep Roof Flashings

Size	Stock #	Order #	A
3"	3GVFSR	140S	3 3/4"
4"	4GVFSR	141S	4 3/4"
5"	5GVFSR	142S	5 3/4"
6"	6GVFSR	143S	6 3/4"
7"	7GVFSR	144S	7 3/4"
8"	8GVFSR	145S	8 3/4"

Tall Cone Roof Flashings

Size	Stock #	Order #	A
14"	14GVFF	280F	12"
16"	16GVFF	281F	12"
18"	18GVFF	282F	12"
20"	20GVFF	283F	12"
22"	22GVFF	284F	12"
24"	24GVFF	285F	12"
26"	26GVFF	286F	12"
28"	28GVFF	287F	12"
30"	30GVFF	288F	12"

SIMPSON**Dura-Vent**

Round Gas Vent

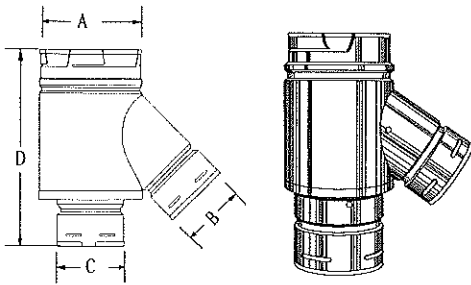

Double Wall Y's with 45° Branch

Size	Stock #	Order #	A	B	C	D
4"x4"x3"	4GVY43	425	4 5/8"	4 5/8"	3 5/8"	12 1/4"
4"x4"x4"	4GVY44	426	4 5/8"	4 5/8"	4 5/8"	13 1/4"
4"x3"x4"	4GVY34	427	4 5/8"	3 5/8"	4 5/8"	13 1/4"
5"x3"x4"	5GVY34	430	5 5/8"	3 5/8"	4 5/8"	12 1/4"
5"x4"x4"	5GVY44	431	5 5/8"	4 5/8"	4 5/8"	13 1/4"
6"x3"x4"	6GVY34	440	6 5/8"	3 5/8"	4 5/8"	12 1/4"
6"x4"x3"	6GVY43	441	6 5/8"	4 5/8"	3 5/8"	12 1/4"
6"x4"x4"	6GVY44	442	6 5/8"	4 5/8"	4 5/8"	13 1/4"
6"x4"x5"	6GVY45	443	6 5/8"	4 5/8"	5 5/8"	13 1/4"
6"x3"x5"	6GVY35	445	6 5/8"	3 5/8"	5 5/8"	13 1/4"
7"x3"x5"	7GVY35	450	7 5/8"	3 5/8"	5 5/8"	13 1/4"

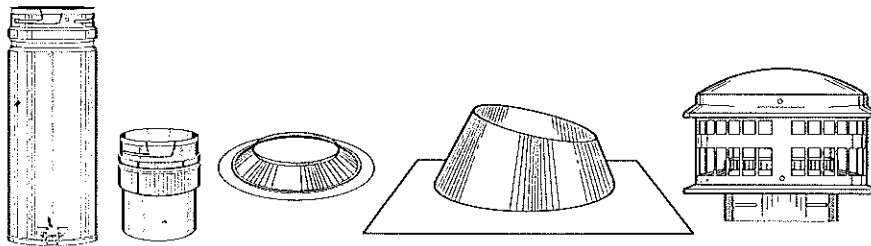

Roof Top Termination Kits

Size	Stock #	Order #
3"	3GVK	470
4"	4GVK	471
5"	5GVK	472

KIT CONTAINS: DuraCap vent top, storm collar, adjustable roof flashing, 12" adjustable length and draft-hood connector.

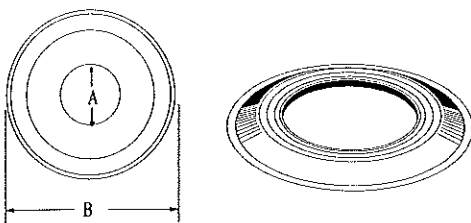

Pipe Collars

Size	Stock #	Order #	A	B
3"	3GVPC	170	3 3/4"	7"
4"	4GVPC	171	4 3/4"	7 3/4"
5"	5GVPC	172	5 3/4"	8 3/4"
6"	6GVPC	173	6 3/4"	9 3/4"

SIMPSON

Dura-Vent

Round Gas Vent

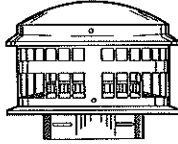
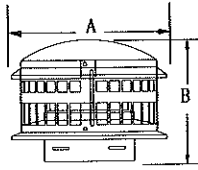

3-8" DuraCap Vent Top

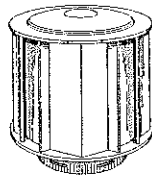
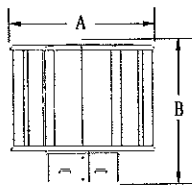

3-8" High Wind Vent Top

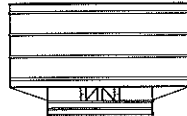
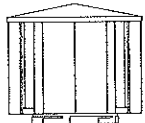

10-18" High Wind Vent Top 20-30"

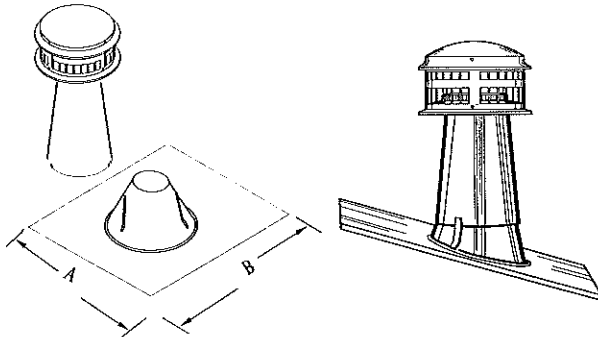

Combo Caps

Size	Stock #	Order #	A	B
3"	3GVTF	360	16"	18 3/8"
4"	4GVTF	361	17	18 3/8
5"	5GVTF	362	18 1/4	20
6"	6GVTF	363	19 1/4	21 1/2

dv Fits 0/12 to 6/12 roof. Caps are UL Listed.

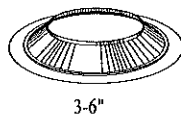
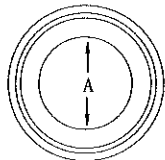

3-6"

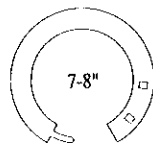

7-8"

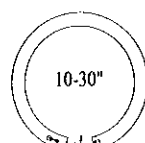

10-30"

DuraCap Vent Tops

Size	Stock #	Order #	A	B
3"	3GVDC	630	8"	5 3/4"
4"	4GVDC	631	8	5 3/4
5"	5GVDC	632	11	7 1/4
6"	6GVDC	633	11	7 1/4
7"	7GVDC	634	15	8
8"	8GVDC	635	15	8

High Wind Vent Tops

Size	Stock #	Order #	A	B
3"	3GVTH	130	7 1/2"	7 1/4"
4"	4GVTH	131	8 1/2	8 1/4
5"	5GVTH	132	9 1/2	9 3/8
6"	6GVTH	133	10 1/2	9 1/4
7"	7GVTH	134	11 1/2	11 3/4
8"	8GVTH	135	12 1/2	12 3/4
10"	10GWT	136	17 1/2	16
12"	12GWT	137	19 1/4	18 3/4
14"	14GWT	260	24	17 1/2

Size	Stock #	Order #	A	B
16"	16GWT	261	26"	19 1/2"
18"	18GWT	262	30	21 1/2
20"	20GWT	263	34	23 1/2
22"	22GWT	264	36	25 1/2
24"	24GWT	265	39	27 1/2
26"	26GWT	266	44	29 1/2
28"	28GWT	267	48	31 1/2
30"	30GWT	268	50	33 1/2

Storm Collars

Size	Stock #	Order #	A	B	Size	Stock #	Order #	A	B
3"	3GVSC	150	3 5/8"	7 3/8"	16"	16GVSC	271	18	23
4"	4GVSC	151	4 5/8	8 1/8	18"	18GVSC	272	20	25
5"	5GVSC	152	5 5/8	9 1/8	20"	20GVSC	273	22	27
6"	6GVSC	153	6 5/8	10 5/8	22"	22GVSC	274	24	29
7"	7GVSC	154	7 5/8	11 1/8	24"	24GVSC	275	26	31
8"	8GVSC	155	8 5/8	12 5/8	26"	26GVSC	276	28	33
10"	10GVSC	156	11	15	28"	28GVSC	277	30	35
12"	12GVSC	157	13	17	30"	30GVSC	278	32	37
14"	14GVSC	270	16"	21"					

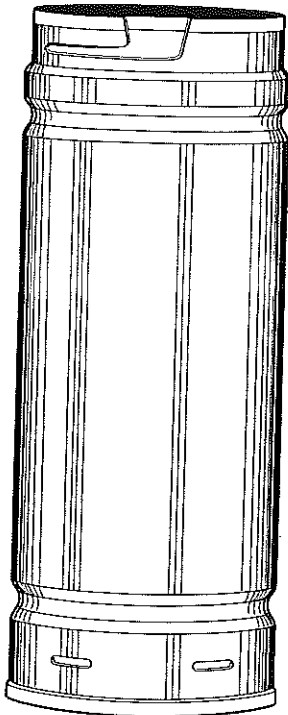

3-16"

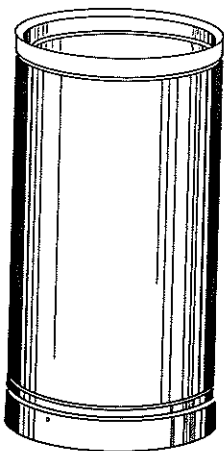

18-30"

3" Diameter - od 3 5/8"

Length	Stock #	Order #
5'	3GV60	1
4'	3GV48	400
3'	3GV36	10
2'	3GV24	385
18"	3GV18	20
12"	3GV12	30
6"	3GV06	40

4" Diameter - od 4 5/8"

Length	Stock #	Order #
5'	4GV60	2
4'	4GV48	401
3'	4GV36	11
2'	4GV24	386
18"	4GV18	21
12"	4GV12	31
6"	4GV06	41

5" Diameter - od 5 5/8"

Length	Stock #	Order #
5'	5GV60	3
4'	5GV48	402
3'	5GV36	12
2'	5GV24	387
18"	5GV18	22
12"	5GV12	32
6"	5GV06	42

6" Diameter - od 6 5/8"

Length	Stock #	Order #
5'	6GV60	4
4'	6GV48	403
3'	6GV36	13
2'	6GV24	388
18"	6GV18	23
12"	6GV12	33
6"	6GV06	43

7" Diameter - od 7 5/8"

Length	Stock #	Order #
5'	7GV60	5
4'	7GV48	404
3'	7GV36	14
2'	7GV24	389
18"	7GV18	24
12"	7GV12	34
6"	7GV06	44

8" Diameter - od 8 5/8"

Length	Stock #	Order #
5'	8GV60	6
4'	8GV48	405
3'	8GV36	15
2'	8GV24	390
18"	8GV18	25
12"	8GV12	35

10" Diameter - od 11"

Length	Stock #	Order #
3'	10GV36	16
18"	10GV18	26

12" Diameter - od 13"

Length	Stock #	Order #
3'	12GV36	17
18"	12GV18	27

14" Diameter - od 15"

Length	Stock #	Order #
3'	14GV36	200
18"	14GV18	220

16" Diameter - od 17"

Length	Stock #	Order #
3'	16GV36	201
18"	16GV18	221

18" Diameter - od 20"

Length	Stock #	Order #
3'	18GV36	202
18"	18GV18	222

20" Diameter - od 22"

Length	Stock #	Order #
3'	20GV36	203
18"	20GV18	223

22" Diameter - od 24"

Length	Stock #	Order #
3'	22GV36	204
18"	22GV18	224

24" Diameter - od 26"

Length	Stock #	Order #
3'	24GV36	205
18"	24GV18	225

26" Diameter - od 28"

Length	Stock #	Order #
3'	26GV36	206
18"	26GV18	226

28" Diameter - od 30"

Length	Stock #	Order #
3'	28GV36	207
18"	28GV18	227

30" Diameter - od 32"

Length	Stock #	Order #
3'	30GV36	208
18"	30GV18	228

NOTE: All items 14" and larger are considered special made and as such, are non-cancelable and non-returnable.