



Permitting and Inspections Department

Fire Alarm Permit Application

Construction Address: 74 West Commercial Street (100)	
Total Square Footage of Proposed Structure: 80,000	
Tax Assessor's Chart, Block & Lot Chart# 59 Block# A Lot# 3 Cost of Work: \$ 5300.00	Applicant Name: Cunningham Security Systems Address: 10 Princes Point Rd Yarmouth, ME 04096 Phone: 846-3350 Email: michelle@cunninghamsecurity.com
Lessee/Owner Name (if different): New Yard LLC Address: 400 Commercial Street Phone: _____ Email: _____	Contractor Name (if different): _____ Address: _____ Phone: _____ Email: _____
Current use (i.e. single family): Warehouse If vacant, what was the previous use? N/A Proposed specific use: Warehouse Is property part of a subdivision? If yes, name: _____ Project description: Installation of an addressable fire alarm system Life Safety Code Occupancy Classification: _____ Is this new work or a renovation to an existing system? New Is the top occupiable floor of the building greater than 75 feet above the lowest level of Fire Department access (high-rise)? No Name of company providing programming and certification of system*: Cunningham Security Systems Electrical permit #: E1ECL2019-02201	
Will a master box be installed? <input checked="" type="radio"/> Yes <input type="radio"/> No If yes, complete all items for approval: AES approved installing contractor: Cunningham Security Systems Documentation of AES approval: _____ Property Owner: Same as above Property Owner Billing Address: Same as above Property common name: Portland Yacht Services E-911 address for protected premises: 74 West Commercial Street Emergency contact phone: 207-774-1067 Additional emergency contact phone: _____ Number of stories protected: 1 Is the building protected by a supervised, automatic sprinkler system? <input checked="" type="radio"/> Yes <input type="radio"/> No	
Name of person to contact when the permit is ready: Michelle O'Brien Address: 10 Princes Point Rd City, State & Zip: Yarmouth, ME 04096 Email Address: michelle@cunninghamsecurity.com Phone: 846-3350	

*For a list of approved fire alarm companies, see www.portlandmaine.gov/1486/Approved-Fire-Alarm-Companies



ES-50X

Intelligent Addressable FACP with Communicator



Addressable Fire Alarm Control Panels

General

The ES-50X is the latest intelligent addressable fire alarm control panel (FACP) from Fire-Lite Alarms and is a direct replacement for the MS-9050UD/LS. The ES-50X comes with a pre-installed communicator and supports up to 50 addressable devices in any combination of detectors or modules. With an extensive list of powerful features, the ES-50X programs just like Fire-Lite's other addressable panels, yet fits into applications previously served only by conventional panels.

The pre-installed IPOTS-COM is a dual technology (POTS and IP) communicator. The POTS transmits system status (alarms, troubles, AC loss, etc.) to a Central Station via the public switched telephone network. The IP communicator's internet monitoring capability sends alarm signals over the Internet saving the monthly cost of two dedicated business telephone lines. Although not required, the secondary telephone line may be retained providing backup communication over the public switched telephone line. Optional cellular reporting is available using the CELL-MOD or CELL-CAB-FL.

Remote and local programming of the control panel is possible using the FS-Tools Upload/Download utility. Programming databases can be uploaded/downloaded via the panel's USB port (and USB cable) or via an ethernet connection using the IPOTS-COM communicator. The USB port also allows for the download or upload of the entire program, history file, walk-test data, current status and system voltages by means of a USB flash drive.

The power supply and all electronics are contained on a circuit board supported on a new quick install chassis and housed in a metal cabinet. Available accessories include local and remote upload/download software, remote annunciators, and reverse polarity/city box transmitter (4XTMF).

Features

- Listed to UL Standard 864, 10th edition
- Pre-installed IPOTS-COM Ethernet IP and POTS (Plain Old Telephone Service) Central Station Communicator
- Optional CELL-MOD or CELL-CAB-FL GSM Central Station Communicator over AlarmNet®
- Compatible with SWIFT® wireless devices
- Auto-programming (learn mode) reduces installation time. Reports two devices set to the same address
- Two independently programmable, built-in Style Z (Class A) or Style Y (Class B) NAC circuits
- Selectable strobe synchronization for System Sensor, Wheelock, and Gentex devices
- Notification Appliance Circuit End of Line resistor matching
- Four programmable function keys for ease of maintenance
- Two programmable relays and one fixed trouble relay
- Built-in Programmer
- Integral 80-character LCD display with backlighting
- Real-time clock/calendar with automatic daylight savings control
- History file with 1,000 event capacity
- Addressable sounder base
- Multi-criteria detector (smoke, heat, CO) with programmable response
- Control module delay timer
- Automatic detector sensitivity testing (NFPA 72 compliant)
- Automatic device type-code verification
- Point trouble identification
- Waterflow selection per module point
- Alarm verification selection per detector point

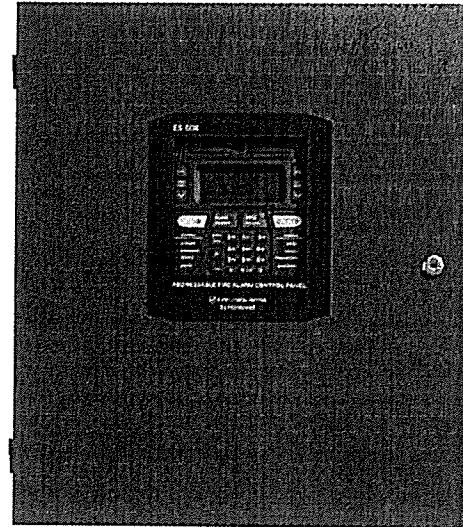

- Maintenance alert warns when smoke detector dust accumulation is excessive
- One-person audible or silent walktest with walktest log & printout
- System alarm verification selection per detector point
- PAS (Positive Alarm Sequence) and Pre-signal per point (NFPA 72 compliant)
- Up to 16 ANN-BUS annunciators- 8 per each ANN-Bus
- Remote Acknowledge, Alarm Silence, Reset and Drill via addressable modules or remote annunciator
- Upload/Download of program and data via USB with optional FS-Tools Programming Utility

SLC COMMUNICATION LOOP

- Supports LiteSpeed™ and CLIP protocols
- SLC operates up to 10,000 ft. (3,000 m) in LiteSpeed mode with twisted, unshielded wire
- Single addressable SLC loop which meets NFPA Class B and Class A requirements
- 50 addressable device capacity (any combination of addressable detectors and modules)
- Compatible with Fire-Lite's addressable devices (refer to the SLC Wiring Manual)

NOTIFICATION APPLIANCE CIRCUITS (NACS)

- Two independently programmable output circuits. Circuits can be configured for the following outputs:
 - Style Y (Class B)
 - Style Z (Class A)
 - Silence Inhibit and Autosilence timer options
 - Continuous, March Time, Temporal, or California code for main circuit board NACs with two-stage capability
 - Selectable strobe synchronization per NAC
 - 2.5 A special application, 250mA regulated, total power for NACs
- NOTE:** Maximum or total 24VDC system power shared between all NAC circuits and the ANN-BUS is 2.7 A

PROGRAMMING AND SOFTWARE

- Autoprogramming (learn mode) reduces installation time



- Custom English labels (per point) may be manually entered or selected from an internal library file
- Two programmable Form-C relay outputs
- 50 software zones
- Continuous fire protection during online programming
- Program Check automatically catches common errors not linked to any zone or input point
- **OFFLINE PROGRAMMING:** Create the entire program in your office using FS-Tools, a Windows®-based software package, and upload/download system programming locally. Offline programming requires an ethernet connection. FS-Tools is available on www.firelite.com.

User interface

LED INDICATORS

- Fire Alarm (red)
- CO Alarm (red)
- AC Power (green)
- Supervisory (yellow)
- Trouble (yellow)
- Ground fault (yellow)
- Battery fault (yellow)
- Disabled (yellow)
- Maintenance (yellow)
- Communication (yellow)
- Alarm Silenced (yellow)
- F1-F4 Programmable Function Keys (yellow)

KEYPAD

- 16 key alpha-numeric pad
- Acknowledge
- Alarm Silence
- Drill (Manual Evacuate)
- Four (4) programmable function keys
- Reset (lamp test)

Product Line Information

ES-50X: Addressable Fire Alarm Control Panel with one SLC loop. Includes main circuit board with display, pre-installed IPOTS-COM communicator, chassis with transformer, backbox with door, plastic bag containing screws, cables, key, etc. (For ES-50XC, refer to DF-60954.)

FS-Tools: Programming software for Windows®-based PC computer. Available for download at www.firelite.com.

CELL-CAB-FL/CELL-MOD: Optional GSM communicators.

IPOTS-COM: Dual technology (POTS and IP) communicator. (replacement board)

DP-ES-R: Optional dress panel for the ES-50X.

TR-CE: Optional trim ring for semi-flush mounting.

BB-2F: Optional cabinet for one or two modules.

BB-6F: Optional cabinet for up to six modules mounted on CHS-6 chassis.

BB-26: Battery backbox, holds up to two 25 AH batteries & CHG-75.

BB-55F: Battery box, houses two 55 AH batteries

CHS-6: Chassis, mounts up to six multi-modules in a BB-6F cabinet.

CHG-75: Battery charger for lead-acid batteries with a rating of 25 to 75 AH.

CHG-120F: Remote battery charging system for lead-acid batteries with a rating of 55 to 120 AH. Requires additional BB-55F for mounting.

BAT Series: Batteries, see data sheet DF-52397.

PRN Series: UL listed compatible event printer. Uses tractor-fed paper.

OPTIONAL MODULES

4XTMF Reverse Polarity Transmitter Module: Provides a supervised output for local energy municipal box transmitter, alarm and trouble. Includes a disable switch and disable trouble LED.

COMPATIBLE ANNUNCIATORS

ANN-30: Remote, red LCD annunciator mimics the information displayed on the FACP LCD display. Recommended wire type is unshielded.

ANN-100: Remote LCD annunciator mimics the information displayed on the FACP LCD display. Recommended wire type is unshielded. For use in FM applications only.

ANN-10: LED Driver Module provides connections to a user supplied graphic annunciator. (See DF-52430.)

ANN-LED: Annunciator Module provides three LEDs for each zone: Alarm, Trouble, and Supervisory. Ships with red enclosure. (See DF-60241.)

ANN-RLED: Provides alarm (red) indicators for up to 30 input zones or addressable points. (See DF-60241.)

ANN-RLY: Relay Module provides 10 programmable Form-C relays. Can be mounted inside the cabinet. (See DF-52431.)

ANN-S/PG: Serial/Parallel Printer Gateway module provides a connection for a serial or parallel printer. (See DF-52429.)

ADDRESSABLE DEVICES

All feature a polling LED and rotary switches for addressing.

SD365: Addressable low-profile photoelectric smoke detector. LiteSpeed only.

SD365-IV: Addressable low-profile photoelectric smoke detector. Ivory. LiteSpeed and CLIP mode.

SD365T: Addressable low-profile photoelectric smoke detector with thermal sensor. LiteSpeed only.

SD365T-IV: Addressable low-profile photoelectric smoke detector with thermal sensor. Ivory. LiteSpeed and CLIP mode.

SD365R: Remote test capable addressable photoelectric smoke detector for use with DNR(W) duct detector housing. LiteSpeed only.

SD365R-IV: Remote test capable addressable photoelectric smoke detector for use with DNR(W) duct detector housing. Ivory. LiteSpeed and CLIP mode.

H365: Low-profile 135°F fixed thermal sensor. LiteSpeed only.

H365-IV: Low-profile 135°F fixed thermal sensor. Ivory. LiteSpeed and CLIP mode.

H365R: Low-profile, intelligent, rate-of-rise thermal sensor. LiteSpeed only.

H365R-IV: Low-profile, intelligent, rate-of-rise thermal sensor. Ivory. LiteSpeed and CLIP mode.

H365HT: Low-profile intelligent 190°F/88°C fixed thermal sensor. LiteSpeed only.

H365HT-IV: Low-profile intelligent 190°F/88°C fixed thermal sensor. Ivory. LiteSpeed and CLIP mode.

Legacy Devices

SD355: Addressable low-profile photoelectric smoke detector.

SD355T: Addressable low-profile photoelectric smoke detector with thermal sensor.

SD355R: Remote test capable addressable photoelectric smoke detector for use with DNR(W) duct detector housing.

SD355CO: Addressable, low-profile device that provides fire, heat, and carbon monoxide (CO) detection.

H355: Fast-response, low-profile heat detector.

H355R: Fast-response, low-profile heat detector with rate-of-rise option.

H355HT: Fast-response, low-profile heat detector that activates at 190°F/88°C.



AD355: Low-profile, intelligent, "Adapt" multi-sensor detector (B350LP base included).

B200S: Programmable, addressable sounder base

B200SR: Addressable sounder base.

BEAM355: Intelligent beam smoke detector.

BEAM355S: Intelligent beam smoke detector with integral sensitivity test.

D355PL: InnovairFlex low-flow non-relay duct-detector housing; includes SD355R.

DNR: InnovairFlex low-flow non-relay duct-detector housing. (Order SD355R/SD365R separately.)

DNRW: InnovairFlex low-flow non-relay duct-detector housing, with NEMA-4 rating. Watertight. (Order SD355R/SD365R separately.)

Addressable Modules

MMF-300: Addressable Monitor Module for one zone of normally-open dry-contact initiating devices. Mounts in standard 4.0" (10.16 cm.) box. Includes plastic cover plate and end-of-line resistor. Module may be configured for either a Style B (Class B) or Style D (Class A) IDC.

MDF-300: Dual Monitor Module. Same as MMF-300 except it provides two Style B (Class B) only IDCs.

MMF-301: Miniature version of MMF-300. Excludes LED and Style D option. Connects with wire pigtailed. May mount in device backbox.

MMF-302: Similar to MMF-300. Addressable Monitor Module for one zone of conventional two-wire detectors. Requires resettable 24 VDC power. Refer to the *Device Compatibility Document* for listed compatible devices and quantity limitation.

CMF-300: Addressable Control Module for one Style Y/Z (Class B/A) zone of supervised polarized Notification Appliances. Mounts directly to a 4.0" (10.16 cm.) electrical box. NAC option requires external 24 VDC to power notification appliances.

CRF-300: Addressable relay module containing two isolated sets of Form-C contacts, which operate as a DPDT switch. Mounts directly to a 4.0" (10.16 cm.) box, surface mount using the SMB500.

BG-12LX: Addressable manual pull station with interface module mounted inside.

I300: This module isolates the SLC loop from short circuit conditions (required for Style 6 or 7 operation).

ISO-6: Six-fault isolator module. Mount one or two modules in a BB-2F cabinet (optional). Mount up to six modules on a CHS-6 chassis in a BB-6F cabinet.

SMB500: Used to mount all modules except MMF-301 and M301.

MMF-300-10: Ten-input monitor module. Mount one or two modules in a BB-2F cabinet (optional). Mount up to six modules on a CHS-6 chassis in a BB-6F cabinet.

MMF-302-6: Six-zone interface module. Mount one or two modules in a BB-2F cabinet (optional). Mount up to six modules on a CHS-6 chassis in a BB-6F cabinet.

CMF-300-6: Six-circuit supervised control module. Mount one or two modules in a BB-2F cabinet (optional). Mount up to six modules on a CHS-6 chassis in a BB-6F cabinet.

CRF-300-6: Six-relay control module (Form-C relays). Mount one or two modules in a BB-2F cabinet (optional). Mount up to six modules on a CHS-6 chassis in a BB-6F cabinet.

SWIFT Wireless Devices

W-GATE: LiteSpeed Wireless Gateway

W-SD355: LiteSpeed intelligent, wireless photo detector.

W-H355R: LiteSpeed intelligent wireless rate of rise (135°) heat detector.

W-SD355T: intelligent wireless photo/heat detector.

W-H355: LiteSpeed intelligent wireless fixed-temperature (135°) heat detector.

W-MMF: LiteSpeed Intelligent wireless monitor module.

W-CRF: LiteSpeed Intelligent wireless relay module.

W-BG12LX: LiteSpeed Intelligent wireless pull station.

WAV-RL, WAV-WL, WAV-CRL, WAV-CWL: LiteSpeed Intelligent AV bases.

W-USB: Wireless USB radio/antenna dongle that plugs into the USB port of a PC running SWIFT Tools.

SWIFT Tools: Programming and diagnostic utility for the Wireless Gateway and devices. Available for download from firelite.com.

NOTE: For more information on Compatible Addressable Devices for use with the ES-50X, see the following data sheets (document numbers): SD365 Series (DF-61010), H365 Series (DF-61011), AD355 (DF-52386), BG-12LX (DF-52013), CMF-300-6 (DF-52365), CRF-300-6 (DF-52374), CMF/CRF Series (DF-52130), CP355 (DF-52383), H355 Series (DF-52385), I300 (DF-52389), ISO-6 (DF-60485), MMF-300 Series/MDF-300 (DF-52121), MMF-300-10 (DF-52347), MMF-302-6 (DF-52356), SD355/SD355T (DF-52384), and SLC Wiring Manual (51309).

NOTE: Legacy 300 Series detection devices such as the CP300/CP350, SD300(T)/SD350(T) and older modules such as the M300, M301, M302, C304, and BG-10LX are not compatible with LiteSpeed polling. If the SLC contains one of these devices, polling must be set for standard CLIP protocol. Please consult factory for further information on previous 300 Series devices.

ADDRESSABLE DEVICE ACCESSORIES

End-of-Line Resistor Assembly (R-47K and R-3.9K): The 47k ohm assembly supervises the MMF-300, MDF-300, MMF-301, and CMF-300 module circuits. The 3.9k ohm assembly supervises the MMF-302 module circuit. These resistors are included with each module.

Power Supervision Relay: Supervises the power to 4-wire smoke detectors and notification appliances.

Wiring Requirements

While shielded wire is not required, it is recommended that all SLC wiring be twisted-pair to minimize the effects of electrical interference. Refer to the panel manual for wiring details.



SYSTEM SPECIFICATIONS

System Capacity

- Intelligent Signaling Line Circuits.....1
- Addressable device capacity50
- Programmable software zones50
- Annunciators.....16

Electrical Specifications

AC Power: Operates in either 120 or 240 VAC, 50/60 Hz, 3.25 A, auto-sensing- no switch required. Wire size: minimum 14 AWG (2.00 mm²) with 600 V insulation. Nonpower-limited, supervised.

Battery: Two 12 V 18 AH lead-acid batteries. Battery Charger Capacity: 7-18 AH (ES-50X cabinet holds maximum of two 18 AH batteries.)

Communication Loop: Supervised and power-limited.

Notification Appliance Circuits: Terminal Block provides connections for two NACs, Style Y (Class B) or Style Z (Class A). Special Application power. Power-limited, supervised circuitry. Maximum signaling current per circuit: 2.5 amps special application, 250mA regulated. End-of-Line Resistor: 4.7k ohm, ½ watt (P/N 71252 UL listed) for Style Y (Class B) NAC; system capable of 1.9 kΩ - 22 kΩ ELR range. Refer to the *Fire-Lite Device Compatibility Document* for listed compatible devices.

Two Programmable Relays and One Fixed Trouble Relay: Contact rating: 2.0 A @ 30 VDC (resistive), 0.5 A @ 30 VAC (resistive). Form-C relays, non-power-limited, non-supervised.

Cabinet Specifications

Door: 19.26" (48.92 cm.) high x 16.82" (42.73 cm.) wide x 0.72" (1.82 cm.) deep. **Backbox:** 19.00" (48.26 cm.) high x 16.65" (42.29 cm.) wide x 5.25" (13.34 cm.) deep. **Trim Ring (TR-CE):** 22.00" (55.88 cm.) high x 19.65" (49.91 cm.) wide.

Shipping Specifications

Weight: 26.9 lbs. (12.20 kg.) **Dimensions:** 20.00" (50.80 cm.) high x 22.5" (57.15 cm.) wide x 8.5" (21.59 cm.) deep.

Temperature and Humidity Ranges

This system meets NFPA requirements for operation at 0 – 49°C/32 – 120°F and at a relative humidity 93% ± 2% RH (noncondensing) at 32°C ± 2°C (90°F ± 3°F). However, the useful life of the system's standby batteries and the electronic components may be adversely affected by extreme temperature ranges and humidity. Therefore, it is recommended that this system and its peripherals be installed in an environment with a normal room temperature of 15 – 27°C/60 – 80°F.

NFPA Standards

The ES-50X complies with the following NFPA 72 Fire Alarm Systems requirements:

- **LOCAL** (Automatic, Manual, Waterflow and Sprinkler Supervisory).
- **AUXILIARY** (Automatic, Manual and Waterflow) (requires 4XTMF).
- **REMOTE STATION** (Automatic, Manual and Waterflow) (Where a DACT is not accepted, the alarm, trouble and supervisory relays may be connected to UL 864 listed transmitters. For reverse polarity signaling of alarm and trouble, 4XTMF is required.)
- **PROPRIETARY** (Automatic, Manual and Waterflow).
- **CENTRAL STATION** (Automatic, Manual and Waterflow, and Sprinkler Supervised).
- **OT, PSDN** (Other Technologies, Packet-switched Data Network)
- **IBC 2012, IBC 2009, IBC 2006, IBC 2003, IBC 2000** (Seismic).
- **CBC 2007** (Seismic)

Agency Listings and Approvals

The listings and approvals below apply to the basic ES-50X control panel. In some cases, certain modules may not be listed by certain approval agencies, or listing may be in process. Consult factory for latest listing status.

- **UL:** S624
- **FM approved**
- **CSFM:** 7165-0075:0500
- **FDNY:** COA #6261

NOTE: See DF-60954 for ULC-listed model.

AlarmNet®, Fire-Lite® Alarms, SWIFT®, and System Sensor® are registered trademarks of Honeywell International Inc. Microsoft® and Windows® are registered trademarks of the Microsoft Corporation.
©2018 by Honeywell International Inc. All rights reserved. Unauthorized use of this document is strictly prohibited.



This document is not intended to be used for installation purposes.
We try to keep our product information up-to-date and accurate.
We cannot cover all specific applications or anticipate all requirements.
All specifications are subject to change without notice.

For more information, contact Fire-Lite Alarms. Phone: (800) 627-3473, FAX: (877) 699-4105.
www.firelite.com



Country of Origin: USA



MMF-301(A) Mini Monitor Module

- Built-in type identification automatically identifies this device as a monitor module to the panel.
- Powered directly by two-wire SLC loop. No additional power required.
- High noise (EMF/RFI) immunity.
- Tinned, stripped leads for ease of wiring.
- Direct-dial entry of address: 01 – 159 on MS-9600 series panels, 01 – 99 on other compatible systems

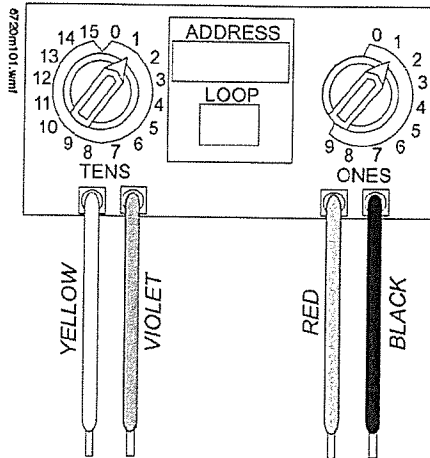

The MMF-301(A) Mini Monitor Module can be installed in a single-gang junction directly behind the monitored unit. Its small size and light weight allow it to be installed without rigid mounting. The MMF-301(A) is intended for use in intelligent, two-wire systems where the individual address of each module is selected using rotary switches. It provides a two-wire initiating device circuit for normally-open-contact fire alarm devices. The MMF-301(A) can be used to replace M301(A) modules in existing systems.

MMF-301(A) APPLICATIONS

Use to monitor a single device or a zone of four-wire smoke detectors, manual fire alarm pull stations, waterflow devices, or other normally-open dry-contact devices. May also be used to monitor normally-open supervisory devices with special supervisory indication at the control panel. Monitored circuit/device is wired as an NFPA Style B (Class B) Initiating Device Circuit. A 47K ohm End-of-Line Resistor (provided) terminates the circuit.

MMF-301(A) OPERATION

Each MMF-301(A) uses one of the available module addresses on an SLC loop. It responds to regular polls from the control panel and reports its type and the status (open/normal/short) of its Initiating Device Circuit (IDC).

MMF-301(A) SPECIFICATIONS

Nominal operating voltage: 15 to 32 VDC.

Average operating current: 350 μ A, 1 communication every 5 seconds, 47k EOL; 600 μ A Max. (Communicating, IDC Shorted).

Maximum IDC wiring resistance: 40 ohms.

Maximum IDC Voltage: 11 Volts.

Maximum IDC Current: 400 μ A.

EOL resistance: 47K ohms.

Temperature range: 32°F to 120°F (0°C to 49°C).

Humidity range: 10% to 93% noncondensing.

Dimensions: 1.3" (3.302 cm) high x 2.75" (6.985 cm) wide x 0.65" (1.651 cm) deep.

Wire length: 6" (15.24 cm) minimum.

MMF-302(A) Interface Module

- Supports compatible two-wire smoke detectors.
- Supervises IDC wiring and connection of external power source.
- High noise (EMF/RFI) immunity.
- SEMS screws with clamping plates for ease of wiring.
- Direct-dial entry of address: 01 – 159 on MS-9600 series panels, 01 – 99 on other compatible systems.
- LED flashes during normal operation.
- LED latches steady to indicate alarm on command from control panel.

The MMF-302(A) Interface Module is intended for use in intelligent, addressable systems, where the individual address of each module is selected using built-in rotary switches. This module allows intelligent panels to interface and monitor two-wire conventional smoke detectors. It transmits the status (normal, open, or alarm) of one full zone of conventional detectors back to the control panel. All two-wire detectors being monitored must be UL compatible with the module. The MMF-302(A) can be used to replace M302(A) modules in existing systems.

MMF-302 (A) APPLICATIONS

Use the MMF-302(A) to monitor a zone of two-wire smoke detectors. The monitored circuit may be wired as an NFPA Style B (Class B) or Style D (Class A) Initiating Device Circuit. A 3.9 K ohm End-of-Line Resistor (provided) terminates the end of the Style B or D (class B or A) circuit (maximum IDC loop resistance is 25 ohms). Install ELR across terminals 8 and 9 for Style D application.

MMF-302(A) OPERATION

Each MMF-302(A) uses one of the available module addresses on an SLC loop. It responds to regular polls from the control panel and reports its type and the status (open/normal/short) of its Initiating Device Circuit (IDC). A flashing LED indicates that the module is in communication with the control panel. The LED latches steady on alarm (subject to current limitations on the loop).

MMF-302(A) SPECIFICATIONS

Nominal operating voltage: 15 to 32 VDC.

Maximum current draw: 5.1 mA (LED on).

Maximum IDC wiring resistance: 25 ohms.

Average operating current: 300 μ A, 1 communication and 1 LED flash every 5 seconds, 3.9k eol.

EOL resistance: 3.9K ohms.

External supply voltage (between Terminals T3 and T4): DC voltage: 24 volts power limited. Ripple voltage: 0.1 Vrms maximum. Current: 90 mA per module maximum.

Temperature range: 32°F to 120°F (0°C to 49°C).

Humidity range: 10% to 93% noncondensing.

Dimensions: 4.5" (11.43 cm) high x 4" (10.16 cm) wide x 1.25" (3.175 cm) deep. Mounts to a 4" (10.16 cm) square x 2.125" (5.398 cm) deep box.



MDF-300(A) Dual Monitor Module

The MDF-300(A) Dual Monitor Module is intended for use in intelligent, two-wire systems. It provides two independent two-wire initiating device circuits (IDCs) at two separate, consecutive addresses. It is capable of monitoring normally open contact fire alarm and supervisory devices. The module has a single panel-controlled LED.

NOTE: The MDF-300(A) provides two Style B (Class B) IDC circuits ONLY. Style D (Class A) IDC circuits are NOT supported in any application.

MDF-300(A) SPECIFICATIONS

Normal operating voltage range: 15 to 32 VDC.

Maximum current draw: 6.4 mA (LED on).

Average operating current: 750 μ A (LED flashing).

Maximum IDC wiring resistance: 1,500 ohms.

Maximum IDC Voltage: 11 Volts.

Maximum IDC Current: 240 μ A

EOL resistance: 47K ohms.

Maximum SLC Wiring resistance: 40 Ohms.

Temperature range: 32° to 120°F (0° to 49°C).

Humidity range: 10% to 93% (non-condensing).

Dimensions: 4.5" (11.43 cm) high x 4" (10.16 cm) wide x 2.125" (5.398 cm) deep.

MDF-300(A) AUTOMATIC ADDRESSING

The MDF-300(A) automatically assigns itself to two addressable points, starting with the original address. For example, if the MDF-300(A) is set to address "26", then it will automatically assign itself to addresses "26" and "27".

NOTE: "Ones" addresses on the MDF-300(A) are 0, 2, 4, 6, or 8 only. Terminals 6 and 7 use the first address, and terminals 8 and 9 use the second address.



CAUTION:

Avoid duplicating addresses on the system.

Installation

MMF-300(A), MMF-302(A), and MDF-300(A) modules mount directly to a standard 4" (10.16 cm) square, 2.125" (5.398 cm) deep, electrical box. They may also be mounted to the SMB500 surface-mount box. Mounting hardware and installation instructions are provided with each module. All wiring must conform to applicable local codes, ordinances, and regulations. These modules are intended for power-limited wiring only.

The MMF-301(A) module is intended to be wired and mounted without rigid connections inside a standard electrical box. All wiring must conform to applicable local codes, ordinances, and regulations.

Agency Listings and Approvals

In some cases, certain modules may not be listed by certain approval agencies, or listing may be in process. Consult factory for latest listing status.

- UL: S2424
- ULC: S2424
- FM Approved
- CSFM: 7300-0075:0185
- MEA: 72-01-E

Product Line Information

NOTE: "A" suffix indicates ULC-listed model.

MMF-300(A): Monitor module.

MMF-301(A): Monitor module, miniature.

MMF-302(A): Monitor module, two-wire detectors.

MDF-300(A): Monitor module, dual, two independent Class B circuits.

SMB500: Optional surface-mount backbox.

NOTE: See installation instructions and refer to the SLC Wiring Manual, PN 51309.

Architects'/Engineers' Specifications

Specifications of these devices and all FireLite products are available from FireLite.



Fire-Lite® and LiteSpeed® are registered trademarks and FireWatch™ is a trademark of Honeywell International Inc.
©2010 by Honeywell International Inc. All rights reserved. Unauthorized use of this document is strictly prohibited.



This document is not intended to be used for installation purposes.
We try to keep our product information up-to-date and accurate.
We cannot cover all specific applications or anticipate all requirements.
All specifications are subject to change without notice.



Made in the U.S. A.

For more information, contact Fire•Lite Alarms. Phone: (800) 627-3473, FAX: (877) 699-4105.
www.firelite.com



Reviewed by Code Enforcement
 Permitting and Inspections
 Department
 12/11/2019



aes-corp.com

8 Zone Fire Subscriber, 8 Supervised Zones, includes 7795 AES-IntelliPro Fire 7788F-ULP-P

Technical Specifications

Please refer to individual product datasheets for detailed technical specifications of each component.

About AES Corporation

AES Corporation is the leading manufacturer of code compliant wireless alarm communication products and solutions serving commercial security markets and government agencies worldwide. AES-IntelliNet™ patented technology will never sunset compared to obsoleting technologies such as cellular and traditional phone lines. AES private mesh radio networks are owner operated and controlled, providing infinite scalability and superior reliability with the fastest transmission speed available. Over a half million AES Smart Subscribers are installed worldwide. AES is the clear choice for life safety and security, protecting people and property for over 40 years.

Faster, Cleaner Installation

No longer required to wire alarm trouble and supervisory outputs on radio

- No relay required
- Ideal replacement for phone lines
- Full alarm signal data
- Flexible options for existing or new installations
- UL 864 Listed for Primary Standalone Alarm Communication

7788F
 Fire Subscriber

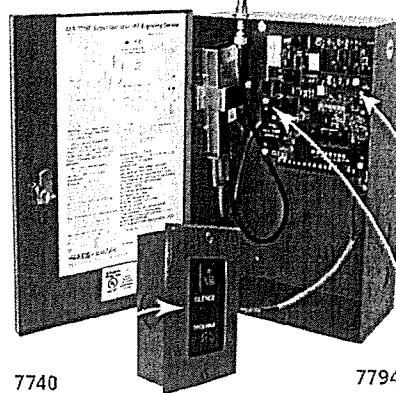

7740
 Local Annunciator

7794 & 7762
 Accessory Boards

AES-IntelliPro Fire Full Data Module (7794) with Hardware Supervisory Module (7762) and Local Annunciator (7740) 7795

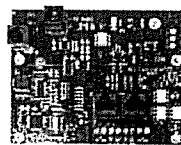

7794
 Full Data Module

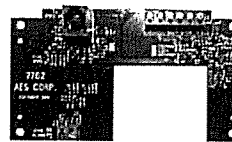

7762
 Hardware Supervisory Module



7740
 Local Annunciator

HOW TO ORDER

Model	Description
7788F-ULP-P	8 Zone Fire Subscriber, 8 Supervised Zones, includes 7795 AES-IntelliPro Fire, Red Enclosure. UL listed for primary standalone communication with fire radios.
7795 (kit)	AES-IntelliPro Fire Full Data Module (7794) with 7762 Hardware Supervisory Module and 7740 AES Local Annunciator. UL listed for primary standalone communication with fire radios.



NetOne

For more information, go to www.aes-corp.com or call
 (800) 237-6387 or contact us at sales@aes-corp.com

© Copyright 2015 AES Corporation | AES-IntelliNet is a registered trademark of AES Corporation



BG-12LX

Addressable Manual Pull Station



Addressable Devices

General

The Fire-Lite BG-12LX is a state-of-the-art, dual-action (i.e., requires two motions to activate the station) pull station that includes an addressable interface (mounted inside) for Fire-Lite's addressable fire alarm control panels (FACPs). Because the BG-12LX is addressable, the control panel can display the exact location of the activated manual station. This leads fire personnel quickly to the location of the alarm.

Features

- Maintenance personnel can open station for inspection and address setting without causing an alarm condition.
- Built-in bicolor LED, which is visible through the handle of the station, flashes in normal operation and latches steady red when in alarm.
- Handle latches in down position and the word "ACTIVATED" appears to clearly indicate the station has been operated.
- Captive screw terminals wire-ready for easy connection to SLC loop (accepts up to 12 AWG/3.25 mm² wire).
- Can be surface mounted (with SB-10 or SB-I/O) or semi-flush mounted. Semi-flush mount to a standard single-gang, double-gang, or 4" (10.16 cm) square electrical box.
- Smooth dual-action design.
- Meets ADAAG controls and operating mechanisms guidelines (Section 4.1.3[13]); meets ADA requirement for 5 lb. maximum activation force.
- Highly visible.
- Attractive shape and textured finish.
- Key reset.
- Includes Braille text on station handle.
- Optional trim ring (BG12TR).
- Meets UL 38, Standard for Manually Actuated Signaling Boxes.

Construction

Shell, door, and handle are molded of durable polycarbonate material with a textured finish.

Specifications

- **Shipping Weight:** 9.6 oz. (272.15 g)
- **Normal operating voltage:** 24 VDC.
- **Maximum SLC loop voltage:** 28.0 VDC.
- **Maximum SLC loop current:** 230 μA.
- **Temperature Range:** 32°F to 120°F (0°C to 49°C)
- **Relative Humidity:** 10% to 93% (noncondensing)
- **For use indoors in a dry location**

Installation

The BG-12LX will mount semi-flush into a single-gang, double-gang, or standard 4" (10.16 cm) square electrical outlet box, or will surface mount to the model SB-10 or SB-I/O surface backbox. If the BG-12LX is being semi-flush mounted, then the optional trim ring (BG12TR) may be used. The BG12TR is

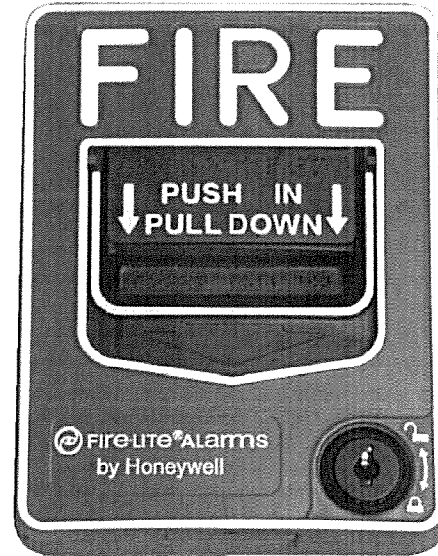

FLPullStation.jpg

usually needed for semi-flush mounting with 4" (10.16 cm) or double-gang boxes (not with single-gang boxes).

Operation

Pushing in, then pulling down on the handle causes it to latch in the down/activated position. Once latched, the word "ACTIVATED" (in bright yellow) appears at the top of the handle, while a portion of the handle protrudes from the bottom of the station. To reset the station, simply unlock the station with the key and pull the door open. This action resets the handle; closing the door automatically resets the switch.

Each manual station, on command from the control panel, sends data to the panel representing the state of the manual switch. Two rotary decimal switches allow address settings (1 – 159 with Breakaway Tab removed for MS-9600 Series, 1 – 99 and MS-9200UDLS, 1 – 50 for MS-9050UD).

Architectural/Engineering Specifications

Manual Fire Alarm Stations shall be non-coded, with a key-operated reset lock in order that they may be tested, and so designed that after actual Emergency Operation, they cannot be restored to normal except by use of a key. An operated station shall automatically condition itself so as to be visually detected as activated. Manual stations shall be constructed of red-colored polycarbonate material with clearly visible operating instructions provided on the cover. The word FIRE shall appear on the front of the stations in white letters, 1.00 inches (2.54 cm) or larger. Stations shall be suitable for surface mounting on matching backbox SB-10 or SB-I/O; or semi-flush mounting on a standard single-gang, double-gang, or 4" (10.16 cm) square electrical box, and shall be installed within



the limits defined by the Americans with Disabilities Act (ADA) or per national/local requirements. Manual Stations shall be Underwriters Laboratories listed.

Manual stations shall connect with two wires to one of the control panel SLC loops. The manual station shall, on command from the control panel, send data to the panel representing the state of the manual switch. Manual stations shall provide address setting by use of rotary decimal switches.

Product Line Information

BG-12LX: Dual-action addressable pull station. Includes key locking feature.

SB-10: Surface backbox; metal.

SB-I/O: Surface backbox; plastic.

BG12TR: Optional trim ring.

17003: Keys, set of two.

Agency Listings and Approvals

In some cases, certain modules or applications may not be listed by certain approval agencies, or listing may be in process. Consult factory for latest listing status.

- **UL Listed:** S711
- **MEA:** 67-02-E
- **CSFM:** 7150-0075:0184
- **FDNY:**
- **FM Approved**

Patented: U.S. Patent No. D428,351; 6,380,846; 6,314,772; 6,632,108.

Fire-Lite is a registered trademark of Honeywell International Inc.
©2010 by Honeywell International Inc. All rights reserved. Unauthorized use
of this document is strictly prohibited.



This document is not intended to be used for installation purposes.
We try to keep our product information up-to-date and accurate.
We cannot cover all specific applications or anticipate all requirements.
All specifications are subject to change without notice.



Made in the U.S. A.

For more information, contact Fire•Lite Alarms. Phone: (800) 627-3473, FAX: (877) 699-4105.
www.firelite.com



Selectable-Output Horns, Strobes, and Horn Strobes

*SpectrAlert® Advance selectable-output horns, strobes,
and horn strobes are rich with features guaranteed to
cut installation times and maximize profits.*

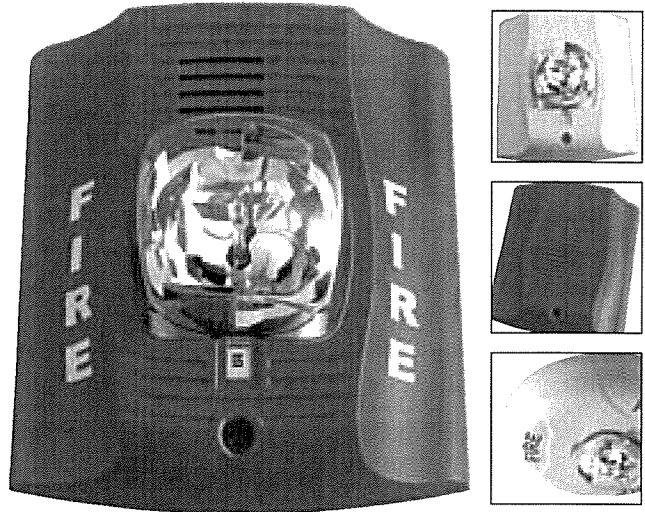

Features

- Plug-in design with minimal intrusion into the back box
- Tamper-resistant construction
- Automatic selection of 12- or 24-volt operation at 15 and 15/75 candela
- Field-selectable candela settings on wall and ceiling units: 15, 15/75, 30, 75, 95, 110, 115, 135, 150, 177, and 185
- Horn rated at 88+ dBA at 16 volts
- Rotary switch for horn tone and three volume selections
- Universal mounting plate for wall and ceiling units
- Mounting plate shorting spring checks wiring continuity before device installation
- Electrically compatible with existing SpectrAlert products
- Compatible with MDL sync module

The SpectrAlert Advance series offers the most versatile and easy-to-use line of horns, strobes, and horn strobes in the industry. With white and red plastic housings, wall and ceiling mounting options, and plain and FIRE-printed devices, SpectrAlert Advance can meet virtually any application requirement.

Like the entire SpectrAlert Advance product line, horns, strobes, and horn strobes include a variety of features that increase their application versatility while simplifying installation. All devices feature plug-in designs with minimal intrusion into the back box, which make installations fast and foolproof while virtually eliminating costly and time-consuming ground faults. Furthermore, a universal mounting plate with an onboard shorting spring tests wiring continuity before the device is installed, protecting devices from damage.

In addition, field-selectable candela settings, automatic selection of 12- or 24-volt operation, and a rotary switch for horn tones with three volume selections enables installers to easily adapt devices to suit a wide range of application requirements.

Agency Listings



S4011 (chimes, horn strobes, horns)
S5512 (strobes)



3023572



MEA452-05-E



7125-1653 186 (indoor strobes)
7125-1653 188 (horn strobes,
chime strobes)
7135-1653 189 (horns, chimes)



SpectrAlert Advance Specifications

Architect/Engineer Specifications

General

SpectrAlert Advance horns, strobes, and horn strobes shall mount to a standard 4 × 4 × 1½-inch back box, 4-inch octagon back box, or double-gang back box. Two-wire products shall also mount to a single-gang 2 × 4 × 1½-inch back box. A universal mounting plate shall be used for mounting ceiling and wall products. The notification appliance circuit wiring shall terminate at the universal mounting plate. Also, SpectrAlert Advance products, when used with the Sync-Circuit™ Module accessory, shall be powered from a non-coded notification appliance circuit output and shall operate on a nominal 12 or 24 volts. When used with the Sync-Circuit Module, 12-volt-rated notification appliance circuit outputs shall operate between 9 and 17.5 volts; 24-volt-rated notification appliance circuit outputs shall operate between 17 and 33 volts. Indoor SpectrAlert Advance products shall operate between 32 and 120 degrees Fahrenheit from a regulated DC or full-wave rectified unfiltered power supply. Strobes and horn strobes shall have field-selectable candela settings including 15, 15/75, 30, 75, 95, 110, 115, 135, 150, 177, and 185.

Strobe

The strobe shall be a System Sensor SpectrAlert Advance Model _____ listed to UL 1971 and shall be approved for fire protective service. The strobe shall be wired as a primary-signaling notification appliance and comply with the Americans with Disabilities Act requirements for visible signaling appliances, flashing at 1 Hz over the strobe's entire operating voltage range. The strobe light shall consist of a xenon flash tube and associated lens/reflector system.

Horn Strobe Combination

The horn strobe shall be a System Sensor SpectrAlert Advance Model _____ listed to UL 1971 and UL 464 and shall be approved for fire protective service. The horn strobe shall be wired as a primary-signaling notification appliance and comply with the Americans with Disabilities Act requirements for visible signaling appliances, flashing at 1 Hz over the strobe's entire operating voltage range. The strobe light shall consist of a xenon flash tube and associated lens/reflector system. The horn shall have three audibility options and an option to switch between a temporal three-pattern and a non-temporal (continuous) pattern. These options are set by a multiple position switch. On four-wire products, the strobe shall be powered independently of the sounder. The horn on horn strobe models shall operate on a coded or non-coded power supply.

Synchronization Module

The module shall be a System Sensor Sync-Circuit model MDL listed to UL 464 and shall be approved for fire protective service. The module shall synchronize SpectrAlert strobes at 1 Hz and horns at temporal three. Also, while operating the strobes, the module shall silence the horns on horn strobe models over a single pair of wires. The module shall mount to a 4¼ × 4¼ × 2½-inch back box. The module shall also control two Style Y (class B) circuits or one Style Z (class A) circuit. The module shall synchronize multiple zones. Daisy chaining two or more synchronization modules together will synchronize all the zones they control. The module shall not operate on a coded power supply.

Physical/Electrical Specifications

Standard Operating Temperature	32°F to 120°F (0°C to 49°C)
Humidity Range	10 to 93% non-condensing
Strobe Flash Rate	1 flash per second
Nominal Voltage	Regulated 12 DC/FWR or regulated 24 DC/FWR ¹
Operating Voltage Range ²	8 to 17.5 V (12 V nominal) or 16 to 33 V (24 V nominal)
Input Terminal Wire Gauge	12 to 18 AWG
Ceiling-Mount Dimensions (including lens)	6.8" diameter × 2.5" high (173 mm diameter × 64 mm high)
Wall-Mount Dimensions (including lens)	5.6" L × 4.7" W × 2.5" D (142 mm L × 119 mm W × 64 mm D)
Horn Dimensions	5.6" L × 4.7" W × 1.3" D (142 mm L × 119 mm W × 33 mm D)
Wall-Mount Back Box Skirt Dimensions (BBS-2, BBSW-2)	5.9" L × 5.0" W × 2.2" D (151 mm L × 128 mm W × 56 mm D)
Ceiling-Mount Back Box Skirt Dimensions (BBSC-2, BBSCW-2)	7.1" diameter × 2.2" high (180 mm diameter × 57 mm high)
Wall-Mount Trim Ring Dimensions (sold as a 5 pack) (TR-HS, TRW-HS)	5.7" L × 4.8" W × 0.35" D (145 mm L × 122 mm W × 9 mm D)
Ceiling-Mount Trim Ring Dimensions (sold as a 5 pack) (TRC-HS, TRCW-HS)	6.9" diameter × 0.35" high (175 mm diameter × 9 mm high)

Notes:

1. Full Wave Rectified (FWR) voltage is a non-regulated, time-varying power source that is used on some power supply and panel outputs.
2. P, S, PC, and SC products will operate at 12V nominal only for 15 and 15/75 cd.



UL Current Draw Data

UL Max. Strobe Current Draw (mA RMS)					
	Candela	8-17.5 Volts		16-33 Volts	
		DC	FWR	DC	FWR
Standard	15	123	128	66	71
Candela Range	15/75	142	148	77	81
	30	NA	NA	94	96
	75	NA	NA	158	153
	95	NA	NA	181	176
	110	NA	NA	202	195
	115	NA	NA	210	205
	High	135	NA	NA	228
Candela Range	150	NA	NA	246	220
	177	NA	NA	281	251
	185	NA	NA	286	258

UL Max. Horn Current Draw (mA RMS)					
Sound Pattern	dB	8-17.5 Volts		16-33 Volts	
		DC	FWR	DC	FWR
Temporal	High	57	55	69	75
Temporal	Medium	44	49	58	69
Temporal	Low	38	44	44	48
Non-temporal	High	57	56	69	75
Non-temporal	Medium	42	50	60	69
Non-temporal	Low	41	44	50	50
Coded	High	57	55	69	75
Coded	Medium	44	51	56	69
Coded	Low	40	46	52	50

UL Max. Current Draw (mA RMS), 2-Wire Horn Strobe, Standard Candela Range (15-115 cd)										
	8-17.5 Volts				16-33 Volts					
	15	15/75	15	15/75	30	75	95	110	115	
DC Input	15	15/75	15	15/75	30	75	95	110	115	
Temporal High	137	147	79	90	107	176	194	212	218	
Temporal Medium	132	144	69	80	97	157	182	201	210	
Temporal Low	132	143	66	77	93	154	179	198	207	
Non-Temporal High	141	152	91	100	116	176	201	221	229	
Non-Temporal Medium	133	145	75	85	102	163	187	207	216	
Non-Temporal Low	131	144	68	79	96	156	182	201	210	
FWR Input										
Temporal High	136	155	88	97	112	168	190	210	218	
Temporal Medium	129	152	78	88	103	160	184	202	206	
Temporal Low	129	151	76	86	101	160	184	194	201	
Non-Temporal High	142	161	103	112	126	181	203	221	229	
Non-Temporal Medium	134	155	85	95	110	166	189	208	216	
Non-Temporal Low	132	154	80	90	105	161	184	202	211	

UL Max. Current Draw (mA RMS), 2-Wire Horn Strobe, High Candela Range (135-185 cd)										
	16-33 Volts				FWR Input	16-33 Volts				
	135	150	177	185		135	150	177	185	
DC Input	135	150	177	185	FWR Input	135	150	177	185	
Temporal High	245	259	290	297	Temporal High	215	231	258	265	
Temporal Medium	235	253	288	297	Temporal Medium	209	224	250	258	
Temporal Low	232	251	282	292	Temporal Low	207	221	248	256	
Non-Temporal High	255	270	303	309	Non-Temporal High	233	248	275	281	
Non-Temporal Medium	242	259	293	299	Non-Temporal Medium	219	232	262	267	
Non-Temporal Low	238	254	291	295	Non-Temporal Low	214	229	256	262	

Horn Tones and Sound Output Data

Horn and Horn Strobe Output (dBA)										
Switch Position	Sound Pattern	dB	8-17.5 Volts		16-33 Volts		24-Volt Nominal			
			DC	FWR	DC	FWR	Reverberant		Anechoic	
			DC	FWR	DC	FWR	DC	FWR	DC	FWR
1	Temporal	High	78	78	84	84	88	88	99	98
2	Temporal	Medium	74	74	80	80	86	86	96	96
3	Temporal	Low	71	73	76	76	83	80	94	89
4	Non-Temporal	High	82	82	88	88	93	92	100	100
5	Non-Temporal	Medium	78	78	85	85	90	90	98	98
6	Non-Temporal	Low	75	75	81	81	88	84	96	92
7 [†]	Coded	High	82	82	88	88	93	92	101	101
8 [†]	Coded	Medium	78	78	85	85	90	90	97	98
9 [†]	Coded	Low	75	75	81	81	88	85	96	92

[†]Settings 7, 8, and 9 are not available on 2-wire horn strobe.



SpectrAlert Advance Dimensions

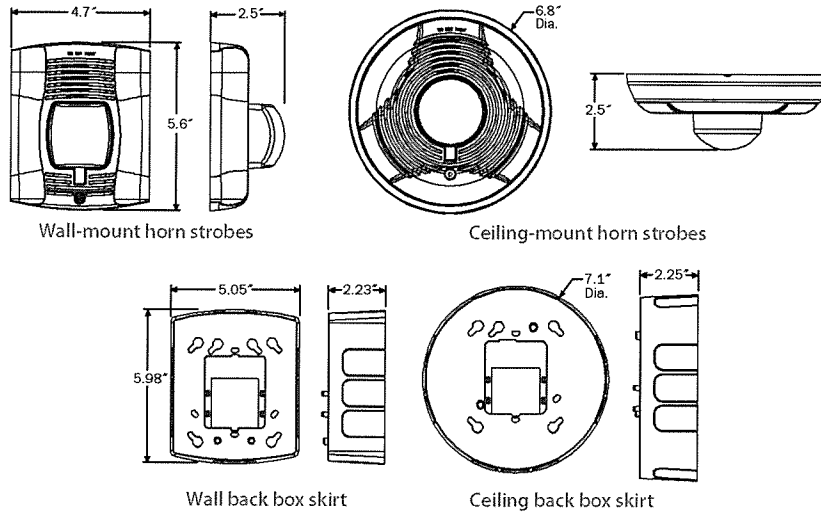

SpectrAlert Advance Ordering Information

Model	Description
Wall Horn Strobes	
P2R*†	2-Wire Horn Strobe, Standard cd*, Red
P2RH*	2-Wire Horn Strobe, High cd, Red
P2W*	2-Wire Horn Strobe, Standard cd, White
P2WH*	2-Wire Horn Strobe, High cd, White
P4R*	4-Wire Horn Strobe, Standard cd, Red
P4RH	4-Wire Horn Strobe, High cd, Red
P4W	4-Wire Horn Strobe, Standard cd, White
Wall Strobes	
SR*†	Strobe, Standard cd, Red
SRH*†	Strobe, High cd, Red
SW*	Strobe, Standard cd, White
SWH*	Strobe, High cd, White
Ceiling Horn Strobes	
PC2R*	2-Wire Horn Strobe, Standard cd, Red
PC2RH	2-Wire Horn Strobe, High cd, Red
PC2W*†	2-Wire Horn Strobe, Standard cd, White
PC2WH*	2-Wire Horn Strobe, High cd, White
PC4R	4-Wire Horn Strobe, Standard cd, Red
PC4RH	4-Wire Horn Strobe, High cd, Red
PC4W	4-Wire Horn Strobe, Standard cd, White

Model	Description
Ceiling Strobes	
SCR	Strobe, Standard cd, Red
SCRH	Strobe, High cd, Red
SCW*	Strobe, Standard cd, White
SCWH	Strobe, High cd, White
Horns	
HR	Horn, Red
HW	Horn, White
Accessories	
BBS-2	Back Box Skirt, Wall, Red
BBSW-2	Back Box Skirt, Wall, White
BBSC-2	Back Box Skirt, Ceiling, Red
BBSCW-2	Back Box Skirt, Ceiling, White
TR-HS	Trim Ring, Wall, Red
TRW-HS	Trim Ring, Wall White
TRC-HS	Trim Ring, Ceiling, Red
TRCW-HS	Trim Ring, Ceiling, White

Notes:

* Add "-P*" to model number for plain housing (no "FIRE" marking on cover), e.g., P2R-P.

† Add "-SP*" to model number for "FUEGO" marking on cover, e.g., P2R-SP.

"Standard cd" refers to strobes that include 15, 15/75, 30, 75, 95, 110, and 115 candela settings. "High cd" refers to strobes that include 135, 150, 177, and 185 candela settings.

