

**1** 8C14 DOOR FRAME DETAIL  
SCALE: 3/4" = 1'-0"

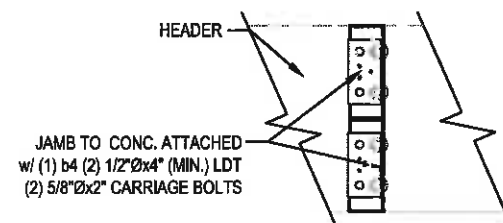

**2** 8C14 HEADER TO JAMB  
SCALE: 3/4" = 1'-0"

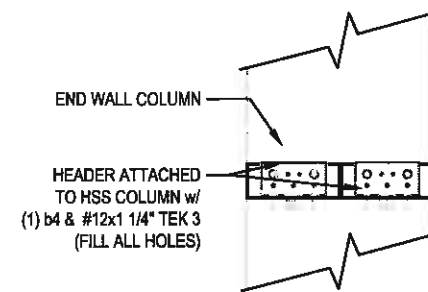

**4** 8C14 TO COLUMN SECTION  
SCALE: 3/4" = 1'-0"

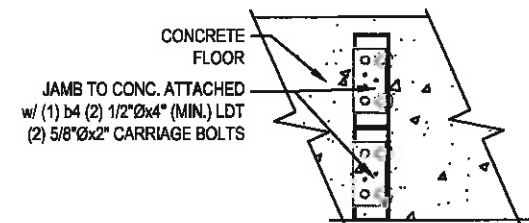

**3** 8C14 JAMB TO CONCRETE  
SCALE: 3/4" = 1'-0"

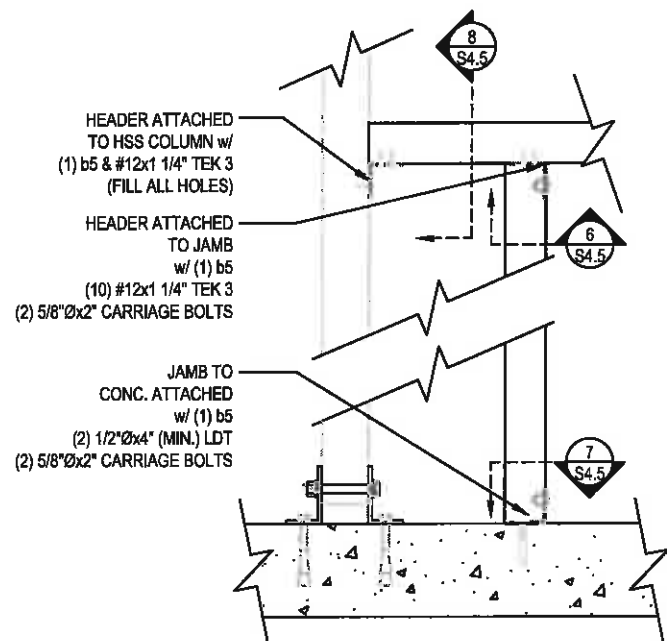

**5** 12C12 DOOR FRAME DETAIL  
SCALE: 3/4" = 1'-0"

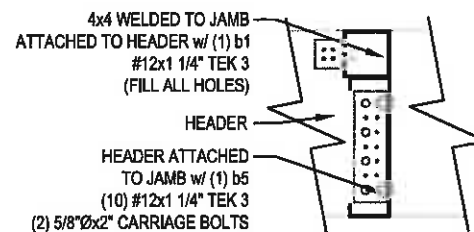

**6** 12C12 HEADER TO JAMB  
SCALE: 3/4" = 1'-0"

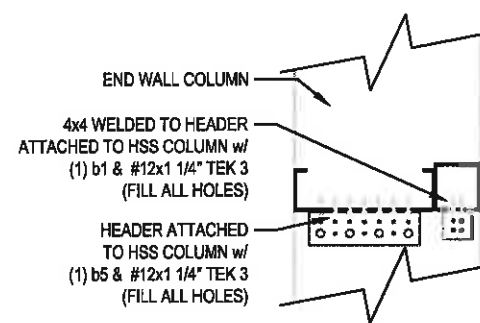

**8** 12C12 TO COLUMN SECTION  
SCALE: 3/4" = 1'-0"

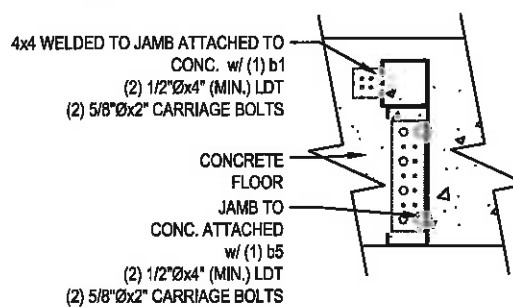

**7** 12C12 JAMB TO CONCRETE  
SCALE: 3/4" = 1'-0"

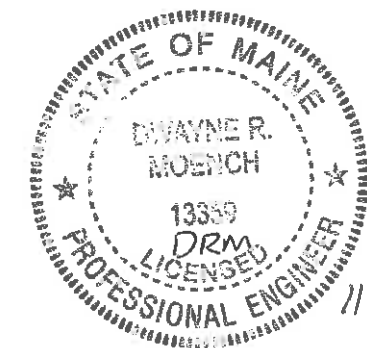

11-13-13



www.LegacyBuildingSolutions.com  
1-877-263-1828

NEWYARD LLC  
120'-0" x 160'-6"  
PORTLAND, ME

Legacy Building Solutions  
19500 County Rd 142  
South Haven, MN 55830  
p. 320-259-7126

THESE DRAWINGS AND THE INFORMATION CONTAINED HEREIN ARE THE PROPERTY OF LEGACY BUILDING SOLUTIONS. NO PART OF THESE DRAWINGS OR INFORMATION MAY BE REPRODUCED OR TRANSMITTED IN ANY FORM OR BY ANY MEANS, ELECTRONIC OR MECHANICAL, INCLUDING PHOTOCOPYING, RECORDING, OR BY ANY INFORMATION STORAGE AND RETRIEVAL SYSTEM, WITHOUT THE WRITTEN PERMISSION OF LEGACY BUILDING SOLUTIONS.

PATENT PENDING

ENDWALL DOOR FRAMING DETAILS

REVISION	DATE
△	11/13/13
△	
△	
△	

DATE:	11/13/13
BY:	DRM
CHECKED:	DRM
APPROVED:	DRM

Sheet Number

S4.5