

1 COLUMN TOP ATTACHMENT
SCALE: 3/4" = 1'-0"

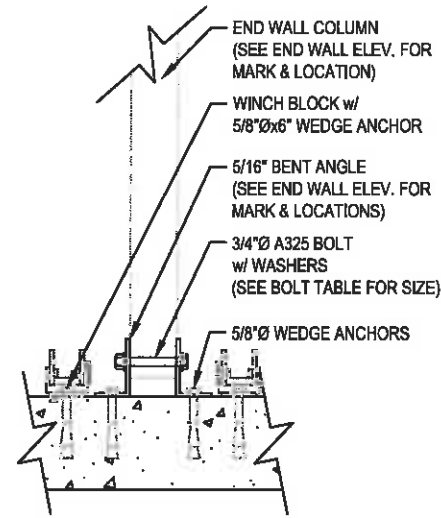

2 COLUMN BOTTOM ATTACHMENT
SCALE: 3/4" = 1'-0"

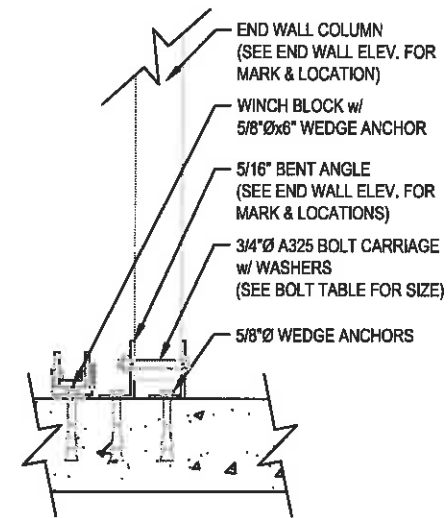

3 COLUMN JAMB ATTACHMENT
SCALE: 3/4" = 1'-0"

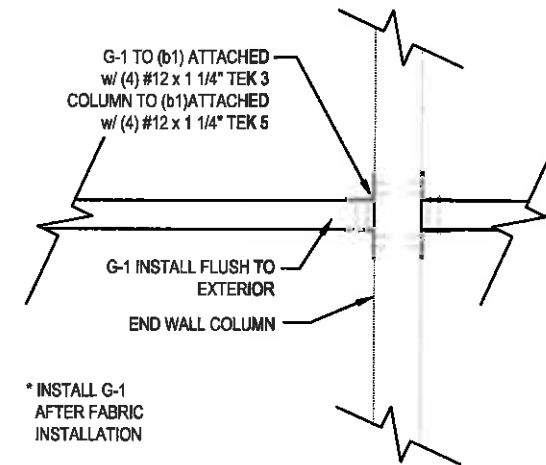

4 ENDWALL GIRT ATTACHMENT DETAIL
SCALE: 3/4" = 1'-0"

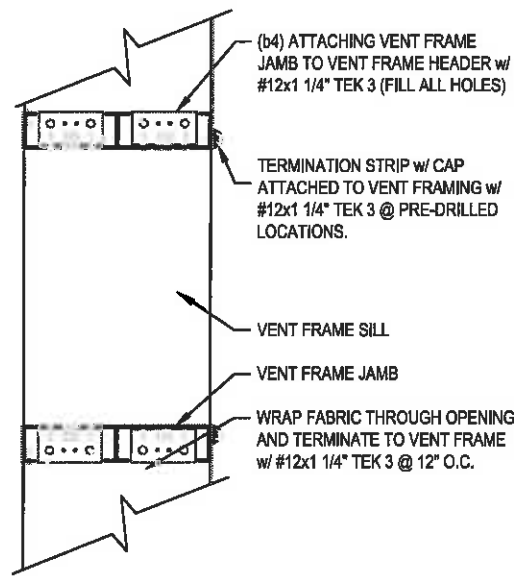

5 VENT FRAME JAMB TO SILL

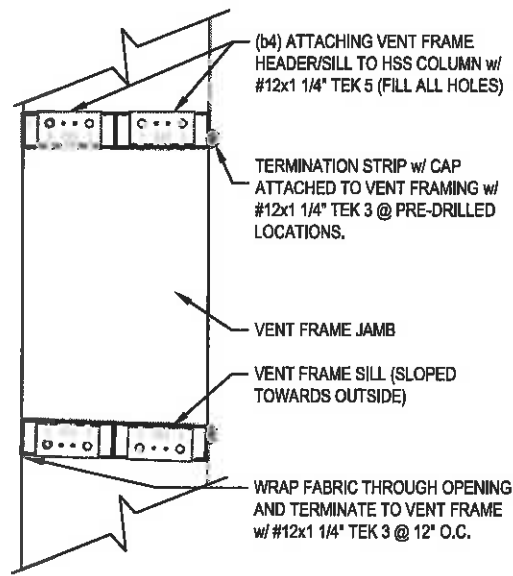

6 VENT FRAME JAMB TO COLUMN

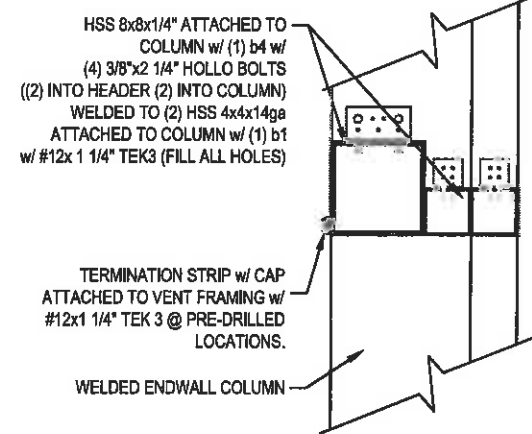

7 DH-3 TO ENDWALL COLUMN

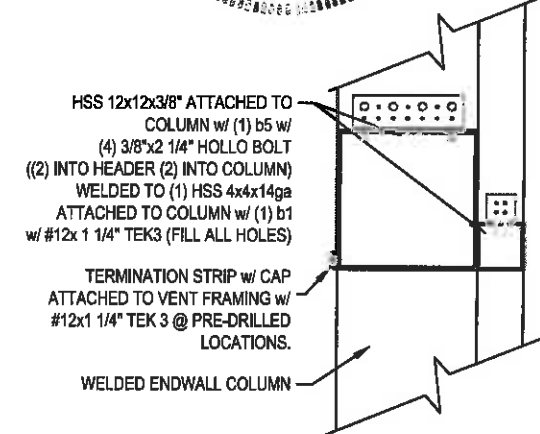

8 DH-4 TO ENDWALL COLUMN

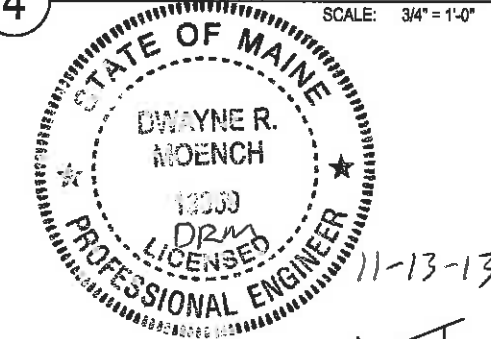

NEWYARD LLC
120'-0" x 160'-0"
PORTLAND, ME

Legacy Building Solutions
19500 County Rd 142
South Haven, MN 55830
p. 320-259-7126

THIS DOCUMENT IS THE PROPERTY OF LEGACY BUILDING SOLUTIONS. IT IS TO BE USED ONLY FOR THE PROJECT AND SITE SPECIFICALLY IDENTIFIED HEREIN. ANY REUSE OR MODIFICATION OF THIS DOCUMENT WITHOUT THE WRITTEN PERMISSION OF LEGACY BUILDING SOLUTIONS IS STRICTLY PROHIBITED.

PATENT PENDING

ENDWALL DETAILS

DATE	BY

PROJECT	
NO.	
DATE	
OWNER	

Sheet Number

S4.4