

TYPICAL DECK SECTION

SCALE: 1/2" = 1'-0"

PRESTRESSED SLAB DIMENSION TABLE				
DIMENSION	A	B	C	D
DECK PANEL A	11'-0"	23	12	10
DECK PANEL B	8'-6"	18	12	9

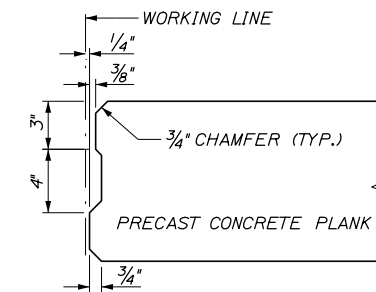

SHEAR KEY DETAIL

SCALE: 2" = 1'-0"

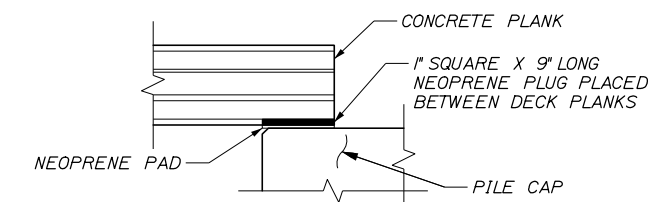

SECTION A-A

SCALE: 1" = 1'-0"

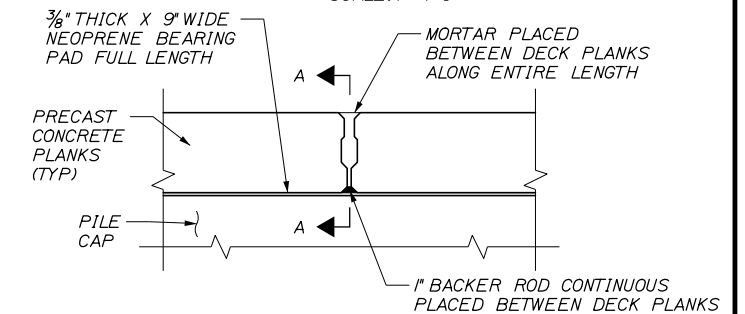

DECK PLANK ASSEMBLY DETAIL

SCALE: 1" = 1'-0"

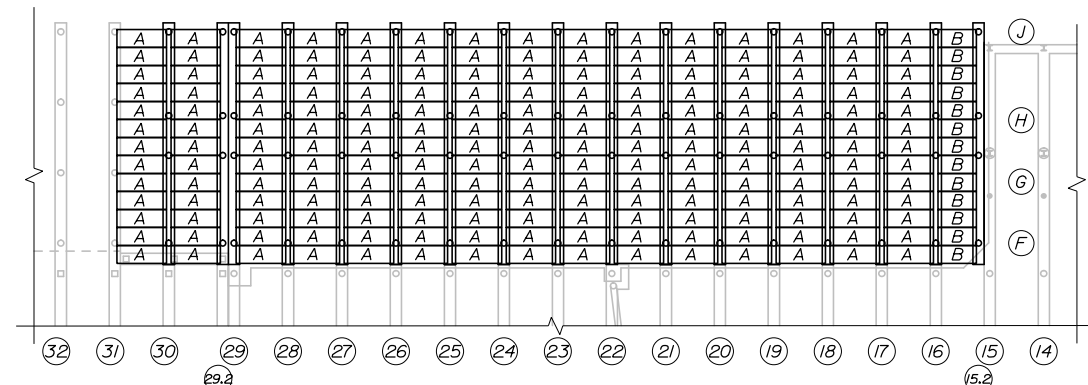

DECK PANEL LAYOUT

N.T.S.

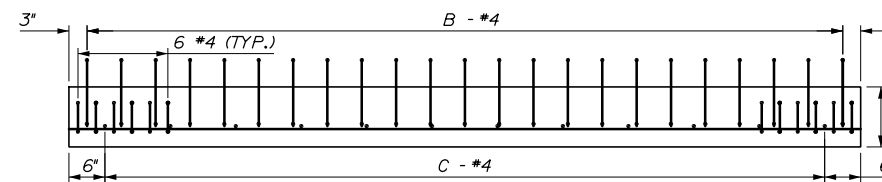

PLAN

STRANDS AND HORIZONTAL STRAIGHT BARS NOT SHOWN FOR CLARITY



SECTION

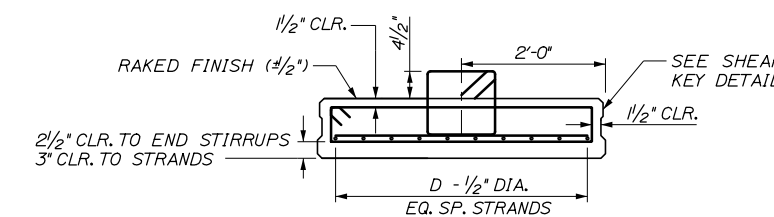

END SECTION

TYPICAL PRESTRESSED SLAB DETAILS

SCALE: 3/4" = 1'-0"

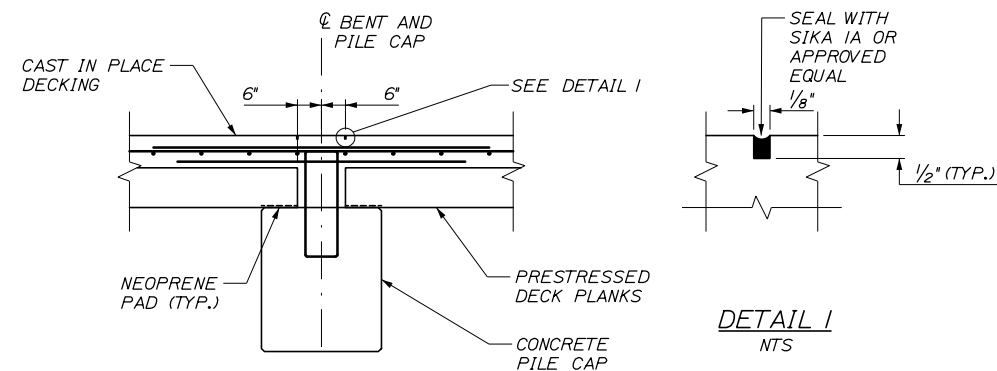

CONTROL JOINT DETAIL

SCALE: 1/2" = 1'-0"

99% DESIGN  
December 15, 2017

DATE	BY	PROJ. MANAGER	DESIGN DETAILED	CHECKED/REVIEWED	DESIGNS DETAILED	REVISIONS 1	REVISIONS 2	REVISIONS 3	REVISIONS 4	FIELD CHANGES
12/17	P. Bishop C. Marin	T. Poulin	J. Burns							

DATE	BY	PROJ. MANAGER	DESIGN DETAILED	CHECKED/REVIEWED	DESIGNS DETAILED	REVISIONS 1	REVISIONS 2	REVISIONS 3	REVISIONS 4	FIELD CHANGES
12/17	P. Bishop C. Marin	T. Poulin	J. Burns							