

DATE	SCALE	PROJECT	REVISIONS
10/15/2011	1/8" = 1'-0"	Elevations	
DESIGNED BY	DRAWN BY	CHECKED BY	DATE
Jason Wentworth	Laundromat		
PROJECT NO.	CLIENT	LOCATION	
	Portland, Maine		

SOUTH WALL

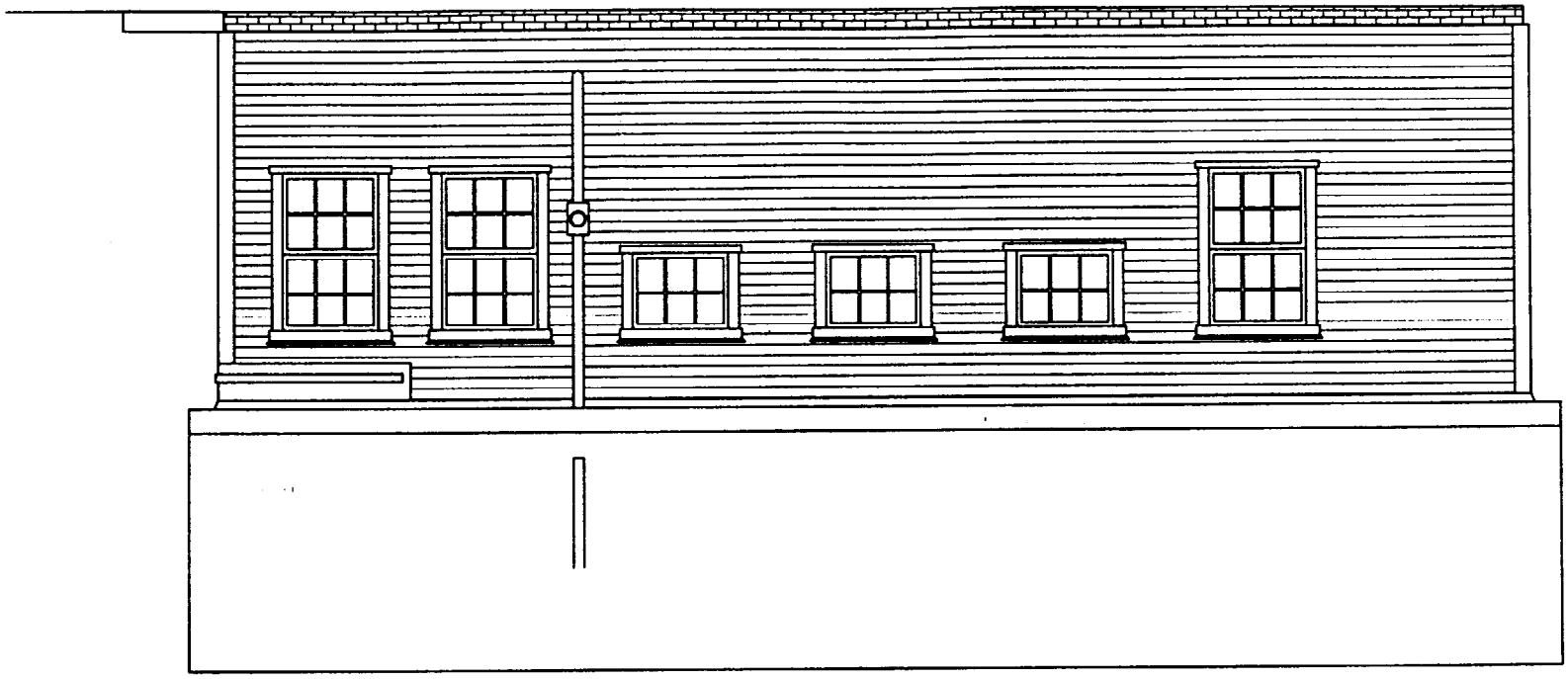

NORTH WALL

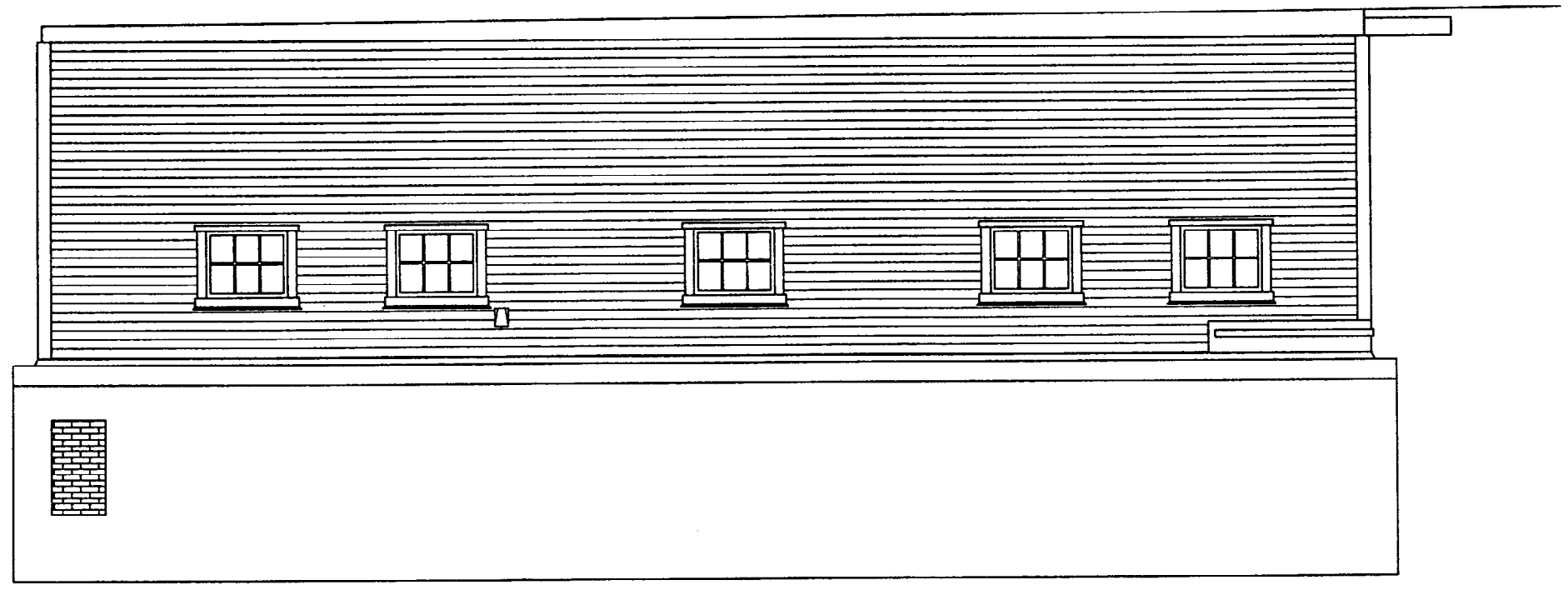

DATE		REVISIONS	
DATE	DESCRIPTION	DATE	DESCRIPTION
SCALE: 1/2" = 1'-0"		PROJECT: Elevations	
CLIENT: Laundromat		LOCATION: Portland, Maine	
DESIGNER: Jason Wentworth	DATE: 01/24/2022	SHEET: 4	

WEST WALL

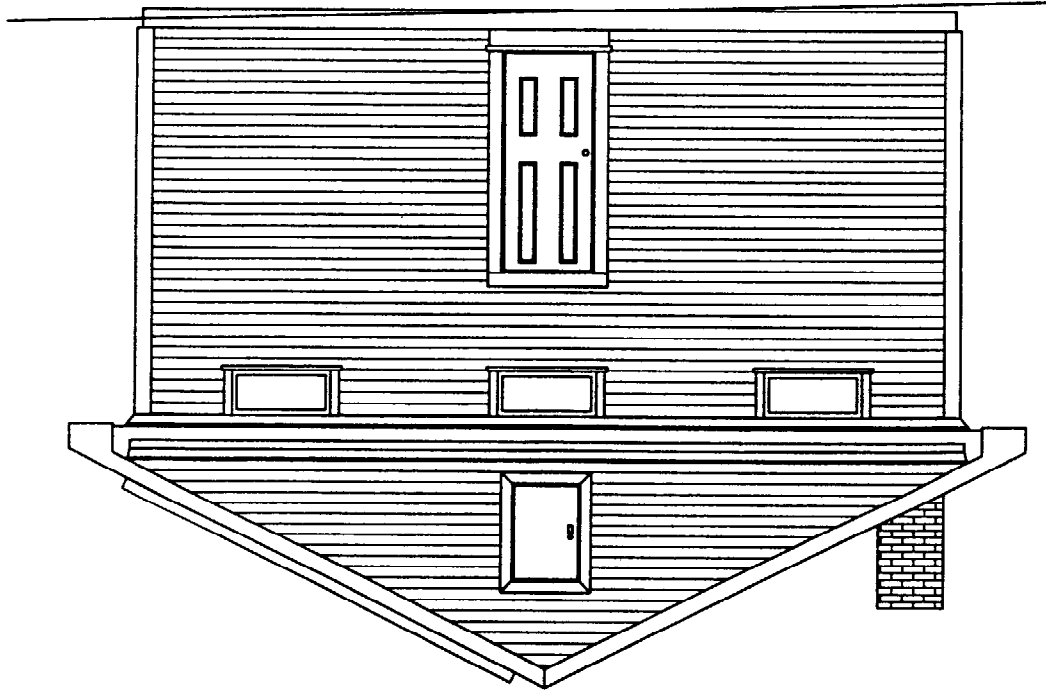

EAST WALL

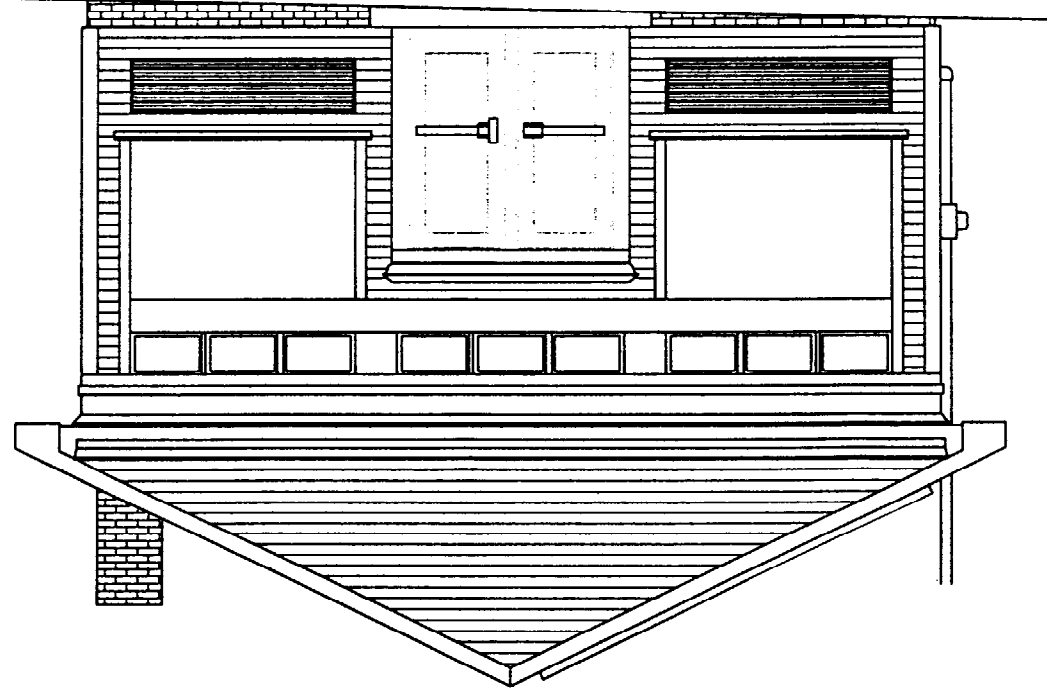

WINDOW SCHEDULE			
LOCATION	UNITS	DESCRIPTION	
NORTH & SOUTH	6	NATURAL WOOD AWNING 36 1/2" X 33 1/2" SDL LOWE GLASS	
SOUTH	3	NATURAL WOOD D.H.	
		4 3/4" (TYP) LOWE SGL DRT 10"	
WEST	3	NATURAL WOOD AWNING 36 1/2" X 21 1/2" 4 3/4" LOWE	
EAST (FRONT)	4	NATURAL WOOD AWNING 26 1/2" X 21 1/2" LOWE PR INT & EXT (TYP)	
EAST (FRONT)	5	NATURAL WOOD AWNING 26 3/4" X 21 1/2" 4 3/4" LOWE FRIMED	
EAST (FRONT)	2	NATURAL WOOD RECT 69 1/2" X 57 1/2" 4 3/4" LOWE TEMP. FRIMED	

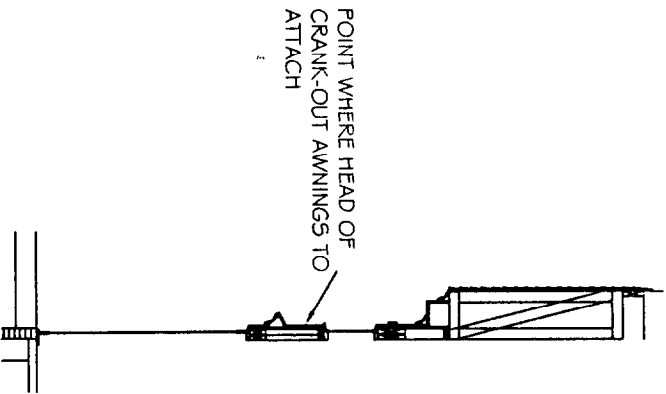

FRONT ENTRANCE
EAST SIDE
SCALE: 3/8" = 1'-0"

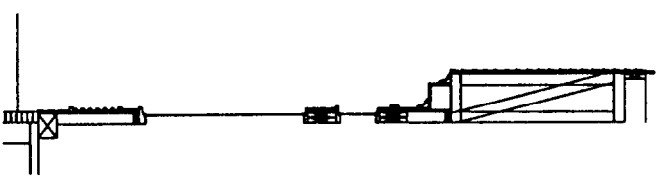

FRONT WINDOW
EAST SIDE
SCALE: 3/8" = 1'-0"

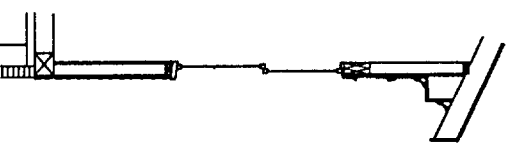

SIDE D.H. WINDOW
SOUTH SIDE
SCALE: 3/8" = 1'-0"

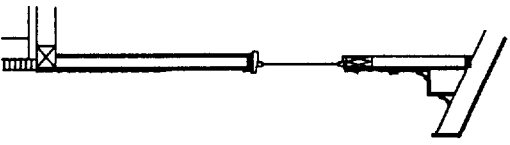

SIDE CASEMENT WINDOW
NORTH & SOUTH SIDE
SCALE: 3/8" = 1'-0"

PROJECT	Windows	DATE	11.05.14
DESIGNER	Jason Wentworth	DATE	01.24.2014
LOCATION	Portland, Maine	DATE	4.14.14
REVISIONS	1/8" = 1'-0"	DATE	4.14.14