

HOOD TO CONTROL PANEL

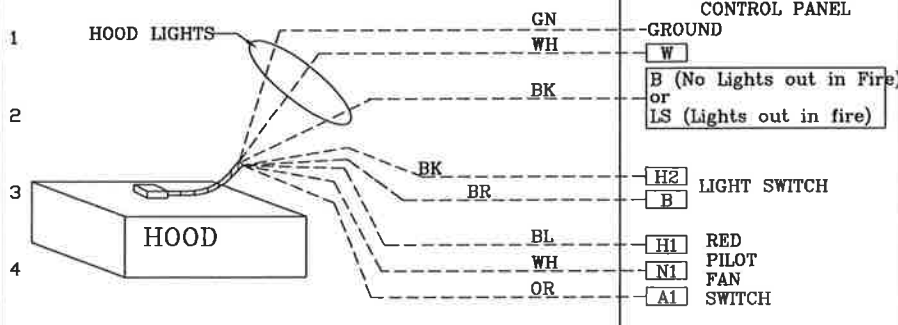

Light switch and fan switch mounted on the face of the hood and control panel mounted separately then field wire to the control panel as shown.

POWER FEED FOR CONTROLS AND LIGHTING

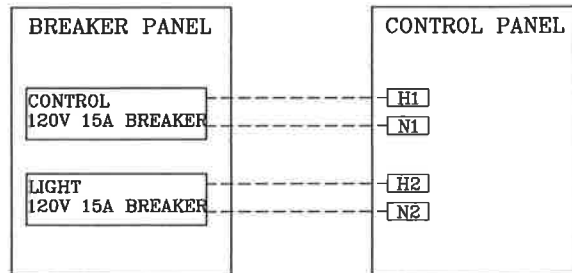

FIELD WIRED SWITCHES TO CONTROL PANEL

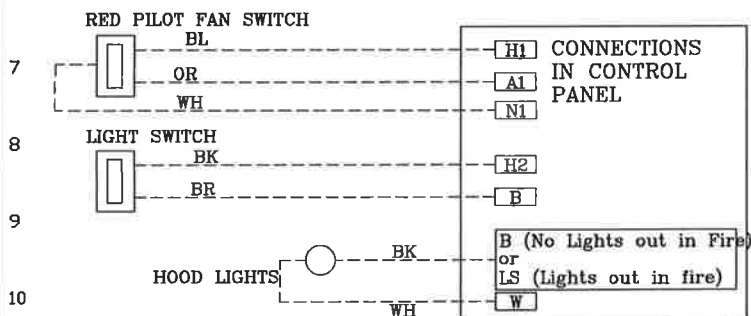

FIRE SYSTEM MICROSWITCH WIRING TO CONTROL PANEL 120VAC SHUNT TRIP BREAKER WIRING

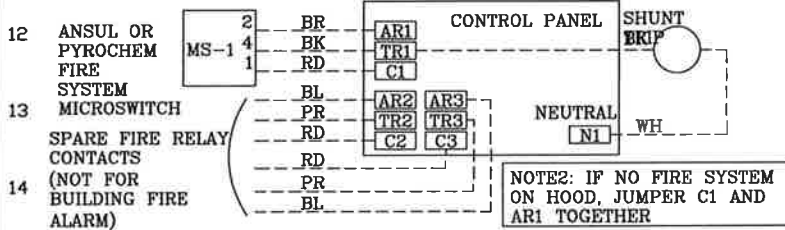

NOTE2: IF NO FIRE SYSTEM ON HOOD, JUMPER C1 AND ARI TOGETHER

NOTE1: BUILDING FIRE ALARM IS TO BE WIRED TO THE "ALARM INITIATING SWITCH" INSIDE THE FIRE SYSTEM AUTOMAN

MICRO-SWITCHES WIRING WHEN MULTIPLE FIRE SYSTEMS CONNECTED TO ONE ELECTRICAL PANEL (3 SHOWN HERE)

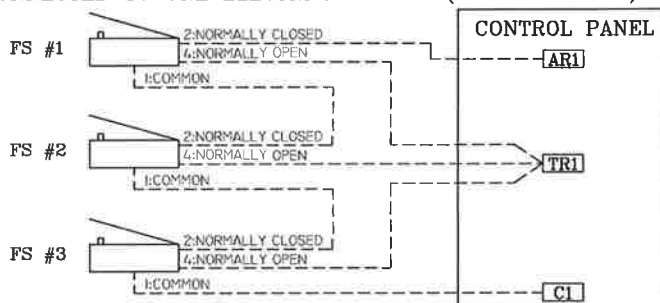

FAN WIRING TO CONTROL PANEL

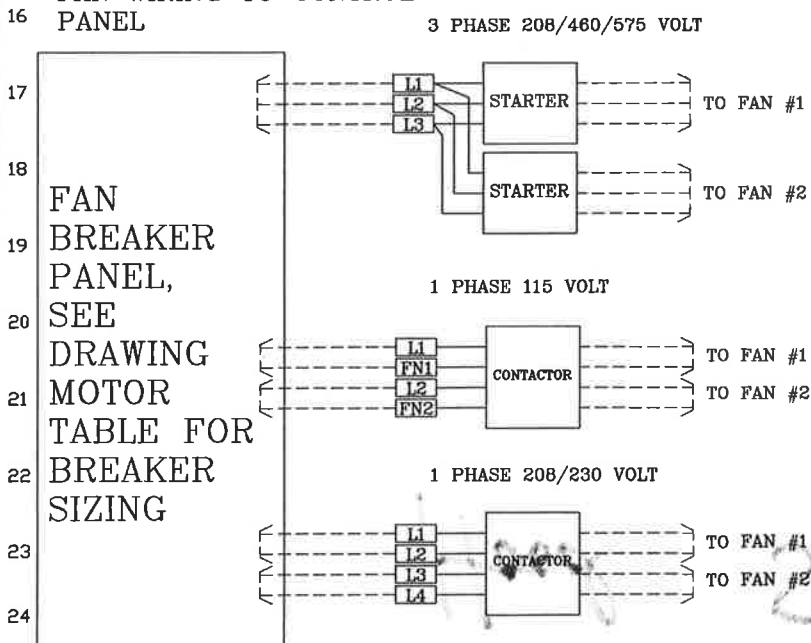

ELECTRIC GAS VALVE WITH RESET RELAY

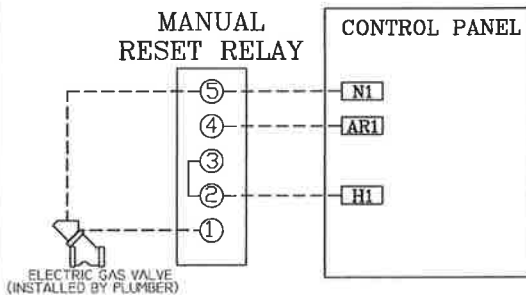

NOTES

--- DENOTES FIELD WIRING
— DENOTES INTERNAL WIRING

WIRE COLOR

- BK - BLACK
- BL - BLUE
- BR - BROWN
- DR - ORANGE
- RD - RED
- WH - WHITE
- GN - GREEN
- YW - YELLOW
- GY - GRAY
- PR - PURPLE
- DR/BL - ORANGE/BLUE (STRIPE)
- BL/RD - BLUE/RED (STRIPE)
- RD/GN - RED/GREEN (STRIPE)